



*Università di Padova - Dipartimento di Ingegneria dell'Informazione,
via Gradenigo 6/b 35131 Padova (Italy)*

Tel. +39.049.827.7600

Fax +39.049.827.7699

TID and SEE Report:

Numonyx Omneo P8P Phase Change Memory

Authors: Marta Bagatin, Simone Gerardin, Alessandro Paccagnella, Università di Padova

The work described in this report was done under
ESA Contract 4000103347/11/NL/PA
"Studies of radiation effects in new generation of non-volatile memories"

Technical officer: Véronique Ferlet-Cavrois, ESA ESTEC, TEC-QEC

v1.0

Date: March 2013

TABLE OF CONTENTS

1	Introduction.....	4
2	Applicable and Reference Documents	4
3	Tested Samples.....	5
4	Total Ionizing Dose Tests.....	6
4.1	Experimental Conditions.....	6
4.2	Experimental Results.....	7
4.2.1	Electrical Behavior during Irradiation	7
4.2.2	Post-radiation Annealing.....	10
5	Single Event Effect Tests	11
5.1	Experimental Conditions.....	11
5.1.1	Irradiation Details	11
5.1.2	Test Setup and Device Conditions during Irradiation	11
5.2	Experimental Results.....	11
5.2.1	Single Event Latch-up.....	12
5.2.2	Single Event Functional Interrupts.....	14
5.2.3	Read Errors.....	15
5.2.4	Permanent Functional Failures.....	15
5.3	Error-rate Calculations	16
6	Conclusions	17

FIGURES

Figure 1: Schematic of a PCM cell with vertical BJT selector (WL = word line, BL = bit line).....	4
Figure 2: Schematic of the test setup for PCM irradiations.	7
Figure 3: Fails after Program1 versus dose during x-ray irradiations.	8
Figure 4: Read fails after Program1 versus dose during x-ray irradiations.	8
Figure 5: Fails after Program2 versus dose during x-ray irradiations.	8
Figure 6: Read fails after Program2 versus dose during x-ray irradiations.	8
Figure 7: Retention errors versus dose during x-ray irradiations.	8
Figure 8: Supply current during gamma exposure.	9
Figure 9: Idle current during gamma exposure as a function of the received dose.	9
Figure 10: Idle current during x-ray exposure as a function of the received dose.	10
Figure 11: SEL cross section as a function of the impinging ion LET. Tests were performed at room temperature. Error bars represent Poisson 95% confidence intervals.	13
Figure 12: SEL cross section as a function of the operating mode (Kr: $E = 305 \text{ MeV}$, $LET = 40.4 \text{ MeV} \cdot \text{mg}^{-1} \cdot \text{cm}^2$). Error bars represent Poisson 95% confidence intervals.	13
Figure 13: Device SEFI cross section for word and buffer program operations. Error bars represent Poisson 95% confidence intervals.	14
Figure 14: Actions needed to restore the device functionality after buffer program errors. Error bars represent 95% confidence intervals, calculate using Poisson statistics.	15
Figure 15: Read-errors burst cross section (Argon beam: $E = 151 \text{ MeV}$, $LET = 15.9 \text{ MeV} \cdot \text{mg}^{-1} \cdot \text{cm}^2$), compared to Buffer program and Word program loop SEFI cross section. Error bars represent Poisson 95% confidence intervals.	15

TABLES

Table 1: Tested devices.....	5
Table 2: Gamma TID runs performed at ESA/ESTEC Co-60 source and x-ray tests performed at the Laboratori Nazionali di Legnaro (LNL).	6
Table 3: Heavy-ion beams used at HIF for this study.	11
Table 4: Heavy-ion runs.....	12
Table 5: Proton runs.	12
Table 6: Permanent functional failures.	16
Table 7: Error rate calculations.....	16

1 Introduction

Phase Change Memories (PCM) are one of the non-volatile memory technologies aiming to replace conventional floating gate devices. Storage in a PCM cell is based on the phase change of a chalcogenide material, which can be switched from amorphous to crystalline by means of proper electrical pulses.

Under ESA Contract 4000103347/11/NL/PA “Studies of radiation effects in new generation of non-volatile memories”, we evaluated total dose and single event effects in 128-Mbit Omneo P8P parts manufactured with a 90-nm phase change technology provided by Numonyx – Agrate Brianza (now part of Micron Technology).

In these devices, the storage element is made of $\text{Ge}_2\text{Sb}_2\text{Te}_5$ (GST). The cells utilize a pnp bipolar selection device, stacked with the cell (**Fig. 1**). The cells can be programmed in a low-resistivity crystalline state (SET) or in a high-resistivity amorphous state (RESET). The two states differ by more than one order of magnitude, in terms of drawn current at the read voltage.

Phase change memories include typical memory circuitry (decoders, etc.), but also charge pumps for the on-chip generation of the voltages required for program and read operations. It is worth to remark that these voltages are much lower as compared to those utilized in floating gate arrays. A 32-word buffer is integrated to speed-up program operations. An on-board microcontroller is used to carry out the required operations.

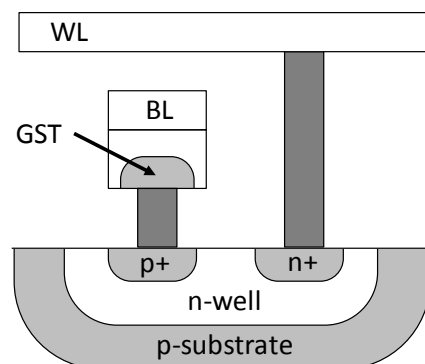

Figure 1: Schematic of a PCM cell with vertical BJT selector (WL = word line, BL = bit line).

The memory can be used in a NOR-compatible way, issuing erase operations before program. However this is not needed in PCM cells, thanks to the different programming mechanism that does not require previous erasure. Throughout our tests, we made use of the full potential of PCM and used bit-alterable operations.

The array is organized in 16-bit words. The memories are compatible with NOR devices (erase and typical NOR Flash operations are emulated), and they feature a separate bus for addresses and data/commands. Typical current values are: standby 80 μA , idle selected 280 μA , program 30 mA.

Two program modes are available: word program and buffer program. In the latter case, faster with large amounts of data, the values to be written in the memory cells are temporarily stored on a buffer prior to being written in the cells.

2 Applicable and Reference Documents

- ESCC22900 Total Ionizing Dose (TID) Testing
- ESCC25100 Single Event Effects (SEE) Testing
- Numonyx Omneo P8P Phase Change Memory datasheet

3 Tested Samples

The details of the tested samples are reported in **Table 1**. The plastic package of the devices to be irradiated with heavy ions and x rays (except two, 4G and 6G) were etched with an acid attack.

Internal Ref.	2G	4E	4G	8E	10E	6G
Part number	NP8P128A1 3TSM60E	NP8P128A1 3TSM60E	NP8P128A1 3TSM60E	NP8P128A13TS M60E	NP8P128A13T SM60E	NP8P128A13T SM60E
Supply voltage	2.7V-3.6V	2.7V-3.6V	2.7V-3.6V	2.7V-3.6V	2.7V-3.6V	2.7V-3.6V
Density	128 Mbit	128 Mbit	128 Mbit	128 Mbit	128 Mbit	128 Mbit
Package	56-pin TSOP	56-pin TSOP	56-pin TSOP	56-pin TSOP	56-pin TSOP	56-pin TSOP
Operating temp	0°C to +70°C	0°C to +70°C	0°C to +70°C	0°C to +70°C	0°C to +70°C	0°C to +70°C
Lot code	Unknown	Unknown	Unknown	Unknown	Unknown	Unknown
Die markings	-	715A823B 705A825C 803B833B 815B9058	-	715A823B 705A825C 803B833B 815B9058	715A823B 705A825C 803B833B 815B9058	-
Die Rev.	B	B	B	B	B	B
Package markings	Z0332059A	Z0332059A	Z0332059A	Z0332059A	Z0332059A	Z0332059A
Test	TID (γ rays)	TID (x rays)	TID (x rays-capped)	TID (x rays)	TID (x rays)	TID (x rays-capped)

Internal Ref.	3	3E	5E	6E	7E
Part no	NP8P128A1 3TSM60E	NP8P128A1 3TSM60E	NP8P128A13TS M60E	NP8P128A13T SM60E	NP8P128A13T SM60E
Supply V	2.7V-3.6V	2.7V-3.6V	2.7V-3.6V	2.7V-3.6V	2.7V-3.6V
Size	128 Mbit	128 Mbit	128 Mbit	128 Mbit	128 Mbit
Package	56-TSOP	56- TSOP	56- TSOP	56-TSOP	56-TSOP
Operating T	0° - 70°C	0° - 70°C	0° - 70°C	0° - 70°C	0° - 70°C
Lot code	Unknown	Unknown	Unknown	Unknown	Unknown
Die markings	715A823B 705A825B 803B833B 815B905B	715A823B 705A825C 803B833B 815B905B	715A823B 705A825C 803B833B 815B905B	715A823B 705A825C 803B833B 815B905B	715A823B 705A825C 803B833B 815B905B
Die Rev.	A	B	B	B	B
Package markings	Z0332059A	Z0332059A	Z0332059A	Z0332059A	Z0332059A
Test	SEE (N,Ne, Ar,Kr,Xe)	SEE (Ar)	SEE (Ar)	SEE (N)	SEE (N)

Table 1: Tested devices.

4 Total Ionizing Dose Tests

4.1 Experimental Conditions

The Co60 gamma source at ESA/ESTEC (Noordwijk, The Netherlands) was used for the irradiation of a single component with a dose rate of ~1.37 rad(Si)/s. The irradiation was carried out in several runs, with short interruptions, needed for some other experiments running in parallel to the PCM exposure.

Further exposures with x rays were performed using a 10-keV x-ray probe station at the Laboratori Nazionali di Legnaro (Padova, Italy). 5 samples were tested with x rays. Four of them were decapped prior to irradiation (4E, 4G, 8E, 10E); one of them was not (6G).

The TID runs are listed in **Table 2**.

Sample	Run	Start	Stop	Source	Dose rate in Si [rad(Si)/s]	Dose in Si [krad(Si)]
2G	2	28/06/2011 10.42	29/06/2011 11.24	ESTEC Co ⁶⁰	1.3775	122.5
2G	3	29/06/2011 11.27	29/06/2011 18.59	ESTEC Co ⁶⁰	1.377	37.3
2G	4	29/06/2011 19.07	30/06/2011 11.52	ESTEC Co ⁶⁰	1.3785	83.2
2G	5	30/06/2011 11.58	30/06/2011 14.57	ESTEC Co ⁶⁰	1.37675	14.8
2G	6	30/06/2011 15.05	30/06/2011 15.23	ESTEC Co ⁶⁰	1.373	1.5
2G	7	30/06/2011 15.25	01/07/2011 9.14	ESTEC Co ⁶⁰	1.37575	88.2
2G	8	01/07/2011 9.18	01/07/2011 10.15	ESTEC Co ⁶⁰	1.37475	4.7
2G	9	01/07/2011 10.17	01/07/2011 13.15	ESTEC Co ⁶⁰	1.375	14.6
2G	10	01/07/2011 13.17	01/07/2011 13.27	ESTEC Co ⁶⁰	1.36675	0.8
2G	11	01/07/2011 13.29	01/07/2011 16.12	ESTEC Co ⁶⁰	1.3745	13.5
2G	12	01/07/2011 16.24	01/07/2011 19.08	ESTEC Co ⁶⁰	1.3745	13.5
2G	13	01/07/2011 19.14	04/07/2011 9.18	ESTEC Co ⁶⁰	1.3735	306.4
4E	1_B	23/02/2012 15.39	26/02/2012 6.05	LNL x rays	10	2242.6
4G	2_B	20/02/2012 12.53	22/02/2012 11.07	LNL x rays	10	1663.7
8E	3_B	29/02/2012 15.17	5/3/2012 14.57	LNL x rays	10	4306.8
10E	4_B	9/03/2012 18.51	12/03/2012 21.41	LNL x rays	10	2693.2
6G	5_B	20/3/2012 11.16	26/3/2012 11.20	LNL x rays	10	5148.1

Table 2: Gamma TID runs performed at ESA/ESTEC Co-60 source and x-ray tests performed at the Laboratori Nazionali di Legnaro (LNL).

The test setup uses an FPGA motherboard controlled by a host PC and a daughterboard with an open-top socket, where the Device Under Test (DUT) is placed. The connection between the two boards is implemented through a couple of high-speed connectors. The supply current drawn by the memory under test is constantly monitored through a PC-controlled multimeter and stored on log. A PC-controlled power supply is used to supply power to the DUT.

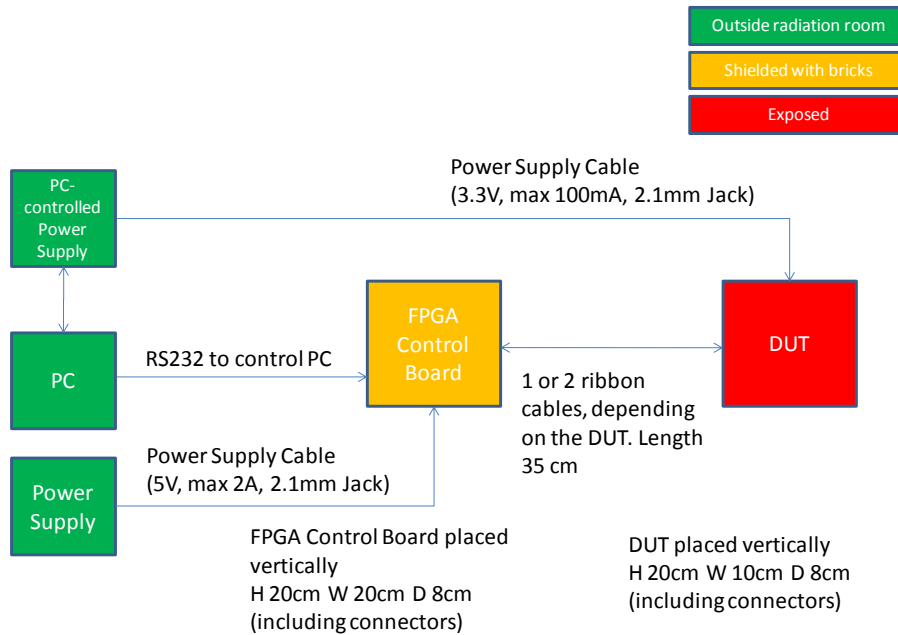

Figure 2: Schematic of the test setup for PCM irradiations.

A schematic illustration of the irradiation setup is shown in **Fig. 2**. The FPGA controlling board is protected from gamma rays through proper shielding bricks available at the ESTEC Co60 facility.

During the TID test, 64-Mbit (i.e., one half of the memory) were continuously exercised with high-duty cycle loops, i.e. with continuous Program/Read/Program/Read (P1/R/P2/R) loops, whereas the other half of the memory array was read (retention test) at the end of each cycle of 10 P1/R/P2/R performed on the first half. The buffer program mode with a pseudo-random pattern was used during the test. The duration of each P1/R/P2/R cycle is about 30 s and the read of the cells kept in retention mode is performed every ~342 s. A log containing all the information on the operations performed on the memory was periodically saved in the PC controlling the experiments. For each operation the status register was monitored.

4.2 Experimental Results

4.2.1 Electrical Behavior during Irradiation

One PCM was measured under gamma irradiation. Overall, a total dose of 700 krad(Si) has been reached without observing any failures. No errors have been detected during gamma exposure up to 700 krad(Si): neither errors attributable to the memory cells (in the part of the memory kept in retention mode), nor in the control circuitry (such as malfunctions observable during read and program cycles).

5 devices were irradiated with x-ray with doses ranging from 1.66 Mrad(Si) to 5.15 Mrad(Si). Two (4G and 10E) out of five exhibited minor functional failures (status register in error after program in about 3% of the tested cells) at about 1.6 Mrad(Si) and 2.6 Mrad(Si). The other samples were still fully functional after doses of 2.20, 4.31, 5.15 Mrad(Si). The errors as a function of doses after the various program and read operations, as well as for cells kept in retention are shown in **Figs. 3-7**.

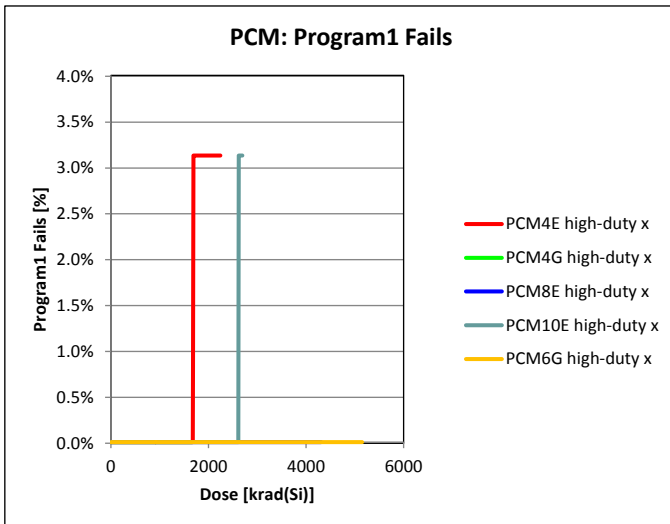

Figure 3: Fails after Program1 versus dose during x-ray irradiations.

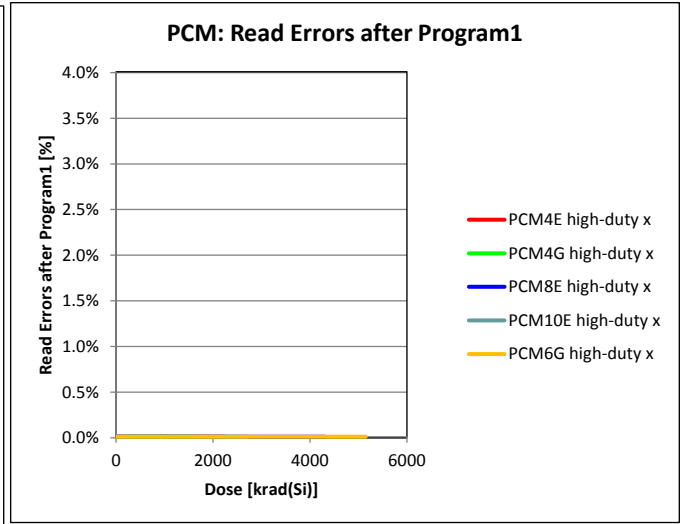

Figure 4: Read fails after Program1 versus dose during x-ray irradiations.

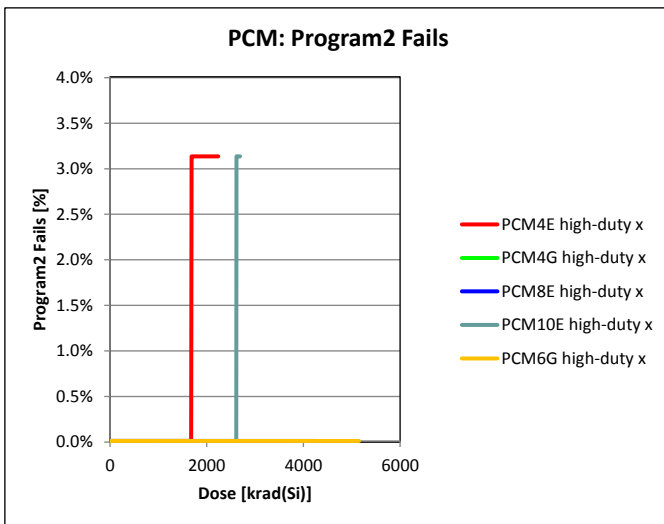

Figure 5: Fails after Program2 versus dose during x-ray irradiations.

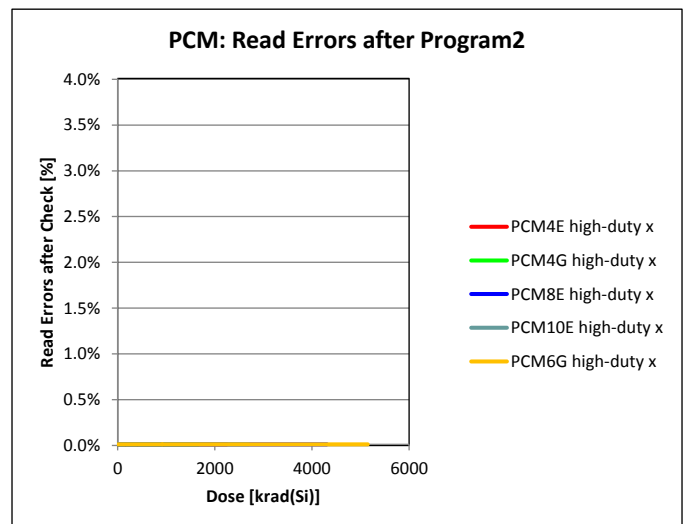

Figure 6: Read fails after Program2 versus dose during x-ray irradiations.

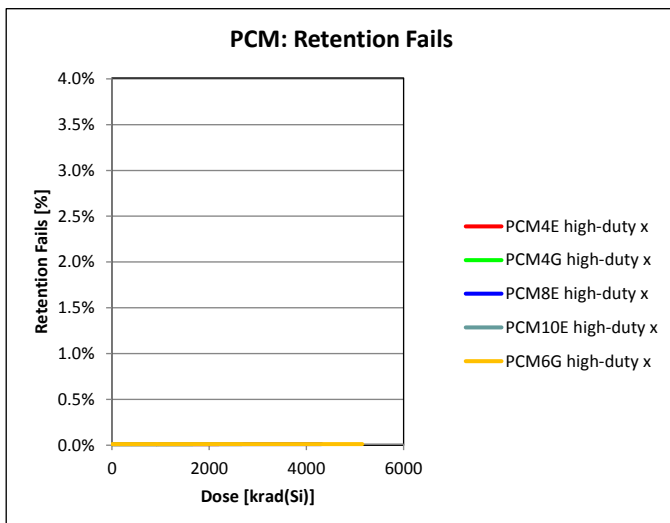

Figure 7: Retention errors versus dose during x-ray irradiations.

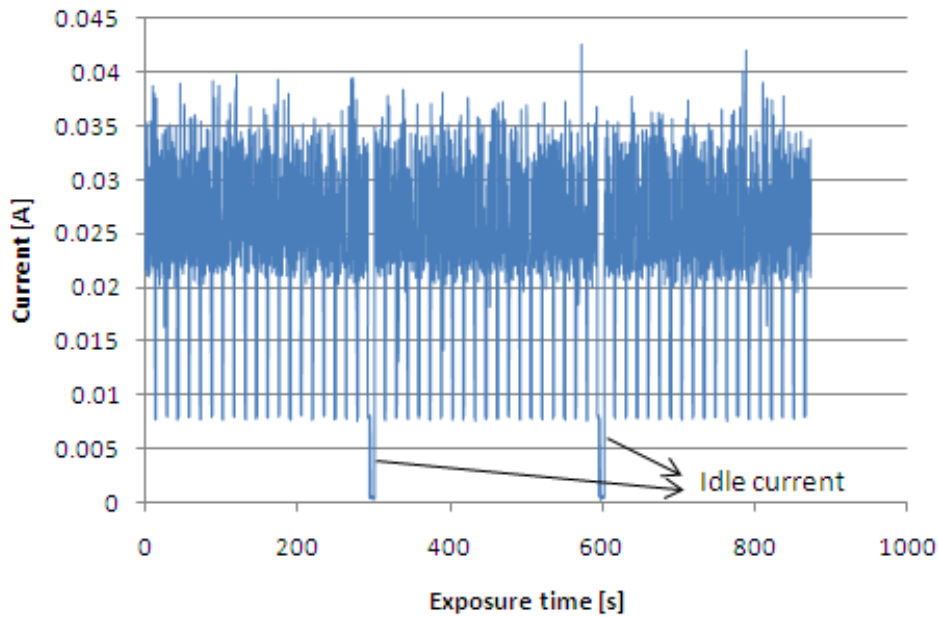

Figure 8: Supply current during gamma exposure.

Concerning the supply current during exposure, **Fig. 8** shows the power supply current at the beginning of the gamma irradiation. The highest values (up to 40 mA) of the current are measured during P/R cycles. The idle current (i.e. with the device selected but not operating) was measured between the various program cycles with an ad-hoc pause in the memory operation. The idle current at the beginning of the irradiation is about 400 μA . **Fig. 9** shows the idle current extracted at different doses during the irradiation. As seen, towards the end of the whole irradiation, at about 700 krad(Si), the standby current is still about 400 μA , i.e., the same as at the beginning of the irradiation. As seen in **Fig. 9**, there are only negligible variations in the standby current. These variations are always below 10% of the nominal standby current.

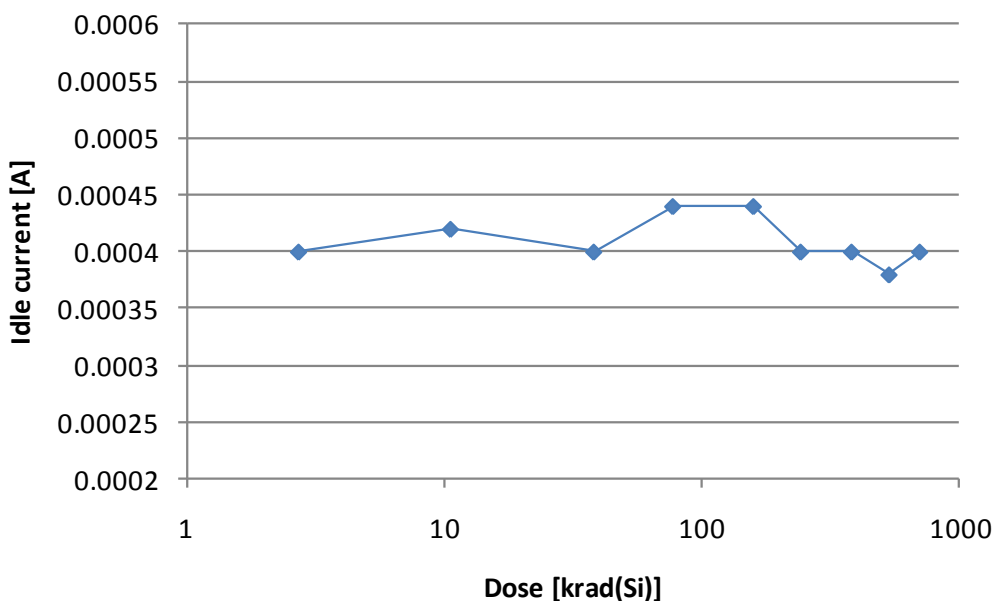

Figure 9: Idle current during gamma exposure as a function of the received dose.

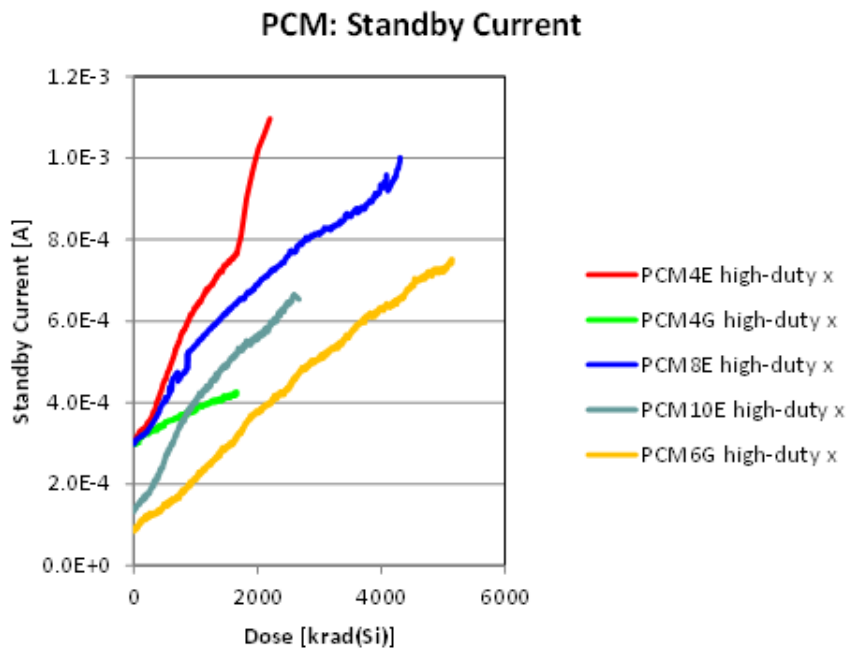

Figure 10: Idle current during x-ray exposure as a function of the received dose.

Fig. 10 shows the idle current of the memory during x-ray irradiation for the 4 PCM samples. As seen, the standby current increases (up to 3x) after 4 Mrad(Si) x-ray exposure.

4.2.2 Post-radiation Annealing

After the gamma exposure, the DUT was stored for 1 week at room temperature with shorted pins. Then the memory was measured, i.e., it was subject to write-read cycles with different patterns, and the standby current was measured again.

Afterwards, the device was baked at 100°C for 1 week at the University of Padova, again with shorted pins. Finally, the PCM was measured again. These measurements showed that the memory was still fully functional and that the idle current was practically unchanged.

5 Single Event Effect Tests

5.1 Experimental Conditions

5.1.1 Irradiation Details

Heavy-ion irradiations were performed at the Heavy Ion Facility (HIF), at Louvain-la-Neuve on decapped devices, with the low-energy cocktail. The details on the heavy-ion beams are reported in **Table 3**. Proton irradiations were performed at the Proton Irradiation Facility (PIF) in Villigen, Switzerland. Irradiation runs are described in **Table 4** and **Table 5**.

All the irradiations have been performed in vacuum, at room temperature, and with the beam normal to the die surface.

5.1.2 Test Setup and Device Conditions during Irradiation

Overall, 4 PCM devices have been tested under heavy-ion beams. The devices were exposed under different static and dynamic conditions. In particular, the following conditions were chosen:

- **Stand-by**: the device was left unselected and exposed to heavy-ions;
- **Read loop**: the device was continuously read during the exposure;
- **Buffer program loop**: the device was alternately programmed with pseudo-random patterns at each iteration, using buffer program operations, and read after each program;
- **Word program loop**: same as buffer program loop, but using 'word program' instead of 'buffer program'.

The test setup consisted of an FPGA motherboard controlled by a host PC and a daughterboard with an open-top socket, where the phase change memory is placed. The connection between the two boards is performed through a couple of high-speed connectors. The supply current drawn by the memory under test is constantly monitored. The beam is immediately stopped by a feed-back signal each time a latch-up or SEFI is detected and until normal functionality is restored after reset or power cycle. A SEFI is defined as a failure to program a cell (or a group of cells, in the case of buffer program) signaled by the memory through the status register, or by the occurrence of a large number of read errors.

5.2 Experimental Results

In the following we will focus on single event effects in the peripheral circuitry. Previous work has demonstrated that PCM cells are very hard to heavy ions. In all the following plots, error bars indicate 95% confidence levels, calculated using Poisson statistics.

The experimental results shown in the following are all referred to sample 3, which corresponds to revision A of the die (see Table 1). On the other hand, devices 3E, 5E, 6E, and 7E (revision B) exhibited functional failure early during irradiation.

Ion species	Energy [MeV]	LET in Si [MeV · cm ² /mg]	Range in Si [μm]
N	60	3.3	59
Ne	78	6.4	45
Ar	151	15.9	40
Kr	305	40.4	39
Xe	420	67.7	37

Table 3: Heavy-ion beams used at HIF for this study.

Run	Ion	Flux [ions/cm ² /s]	Fluence [ions/cm ²]	Device	Duty cycle
1	Ar	10000	7.18E+04	3E	P/R/P/R loop
2	Ar	1000	1.26E+04	3E	P/R/P/R loop
3	Ar	100	2.88E+04	5E	P/R/P/R loop
4	N	100	2.53E+06	6E	P/R/P/R loop
5	N	10000	3.00E+07	6E	P/R/P/R loop
6	N	1000	3.00E+07	3	P/R/P/R loop
7	Ne	10000	4.30E+05	3	P/R/P/R loop
8	Ne	3000	1.59E+05	3	P/R/P/R loop
9	Ar	10000	1.00E+06	3	P/R/P/R loop
10	Ar	800	1.00E+06	3	P/R/P/R loop
11	Ar	800	1.00E+06	3	Pword/R/Pword/R loop
12	Ar	2000	5.79E+05	3	Read loop
13	Ar	10000	1.04E+06	3	Standby
14	Ar	10000	1.00E+07	3	Standby
15	Ar	10000	2.92E+03	3	Standby
16	Kr	1000	8.01E+04	3	Standby
17	Kr	100	6.02E+04	3	Standby
18	Kr	100	4.01E+04	3	Read loop
19	Kr	100	1.93E+03	3	P/R/P/R loop
20	Xe	50	5.38E+03	3	Standby
21	Xe	10	9.19E+03	3	Standby
22	Xe	50	6.06E+03	3	Standby
23	N	1000	1.31E+05	7E	Standby (check for functionality every 10 s)
24	N	5000	3.79E+04	7E	Standby (check for functionality every 10 s)
25	N	17000	1.67E+06	7E	Standby (check for functionality every 10 s)
26	N	17000	3.31E+05	7E	Standby (check for functionality every 100 s)
27	N	17000	1.50E+07	7E	Read loops (check for functionality every 10 s)
28	N	17000	1.31E+07	7E	Read loops (check for functionality every 100 s)

Table 4: Heavy-ion runs.

Ion Species	Energy [MeV]	Fluence [protons/cm ²]	Memory condition	Device	Observed effects
proton	29.4	4.18E+10	E/R/P/R	8G	No events
proton	200	8.6E+10	E/R/P/R	8G	No events
proton	200	1.72E+11	E/R/P/R	8G	No events

Table 5: Proton runs.

5.2.1 Single Event Latch-up

The Single Event Latch-up (SEL) cross section is shown in **Fig. 11**. With supply current limitation, latch-up was not destructive. In only one case a sudden spike in the supply current, which after less than one second went back to its normal value, was observed, likely due to a logic conflict triggered by a SEU.

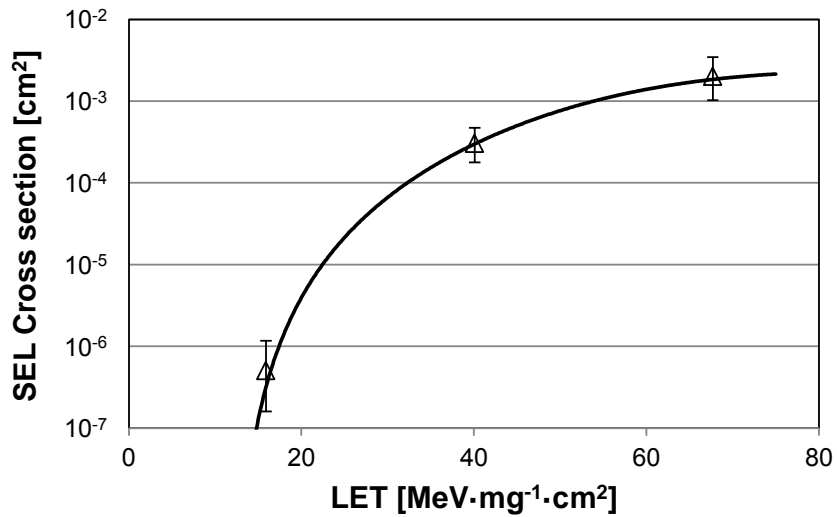

Figure 11: SEL cross section as a function of the impinging ion LET. Tests were performed at room temperature. Error bars represent Poisson 95% confidence intervals.

The heavy-ion cross section curve has been fitted with a Weibull function having the following parameters:

threshold LET: $L_0=12 \text{ MeV}\cdot\text{mg}^{-1}\cdot\text{cm}^2$
width: $W =50 \text{ MeV}\cdot\text{mg}^{-1}\cdot\text{cm}^2$
exponent: $s=3.5$
saturation: $A=2.4\cdot 10^{-3} \text{ cm}^2$

Fig. 12 shows that the SEL cross section does not depend on the operating mode. Even in stand-by mode with several blocks turned off, the SEL cross-section does not decrease.

No SELs were observed under proton irradiations.

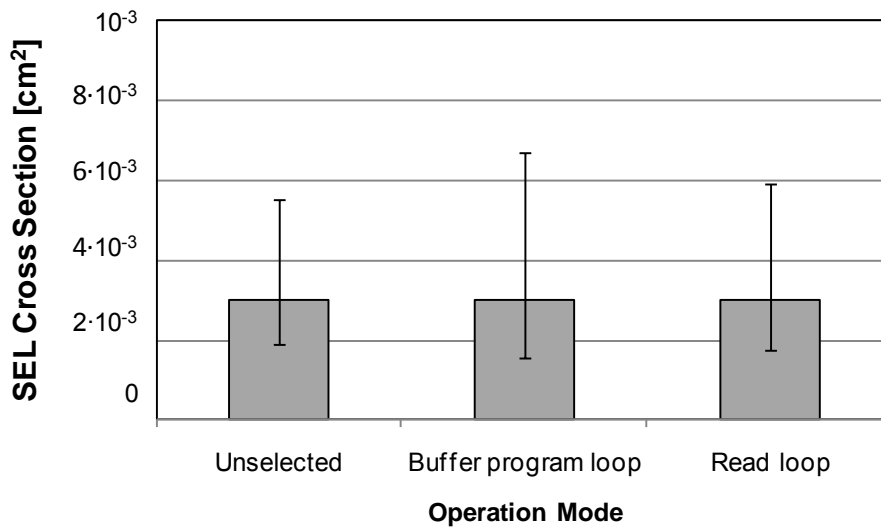

Figure 12: SEL cross section as a function of the operating mode (Kr: $E = 305 \text{ MeV}$, $\text{LET} = 40.4 \text{ MeV} \cdot \text{mg}^{-1} \cdot \text{cm}^2$). Error bars represent Poisson 95% confidence intervals.

5.2.2 Single Event Functional Interrupts

Single Event Functional Interrupts (SEFIs) during program operations were detected in two ways. Most of the time, errors during word and buffer program were signaled by the chip through dedicated bits in the status registers. Yet, other times, the status register reported a successful operation, but a following read (performed after power-cycle and reset) showed that the array had not been properly programmed. It is worth to note that the pattern stored in the memories were continuously switched from two sets of pseudo-random data.

Fig. 13 displays the device SEFI cross section during buffer program loops and, only for memories irradiated with Argon beam, also for word program loop.

The heavy ion cross section curve has been fitted with a Weibull function having the following parameters:

threshold LET:	$L_0=5.5 \text{ MeV}\cdot\text{mg}^{-1}\cdot\text{cm}^2$
width:	$W =23 \text{ MeV}\cdot\text{mg}^{-1}\cdot\text{cm}^2$
exponent:	$s=1.5$
saturation:	$A=1.10\cdot 10^{-4} \text{ cm}^2$

At intermediate LET, where the data have been taken, word program and buffer program have close cross sections. This cross section likely corresponds to that of the sensitive bits in the onboard microcontroller, which manages both kinds of operations.

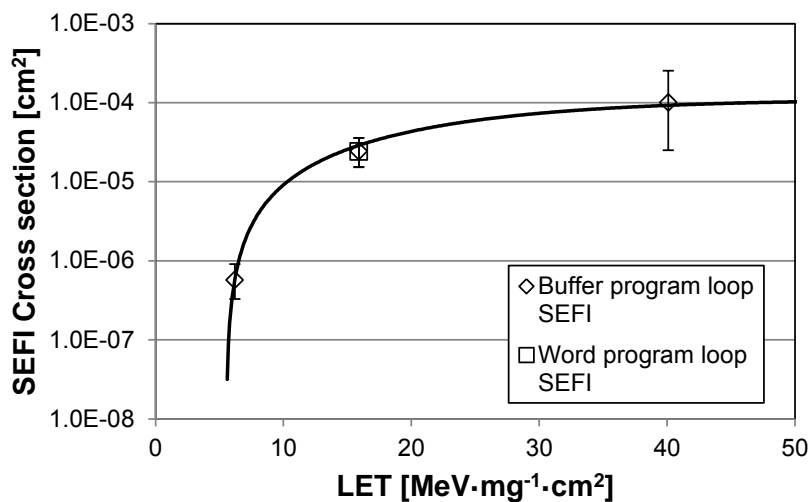

Figure 13: Device SEFI cross section for word and buffer program operations. Error bars represent Poisson 95% confidence intervals.

Fig. 14 shows the actions needed to restore the normal functionality after an error. At low LET, a simple reset is effective most of the time; at higher LET, a power-cycle is required in 50% of the cases. In very few cases, repeating the operation was enough to cure the SEFI.

No SEFIs were observed under proton irradiations.

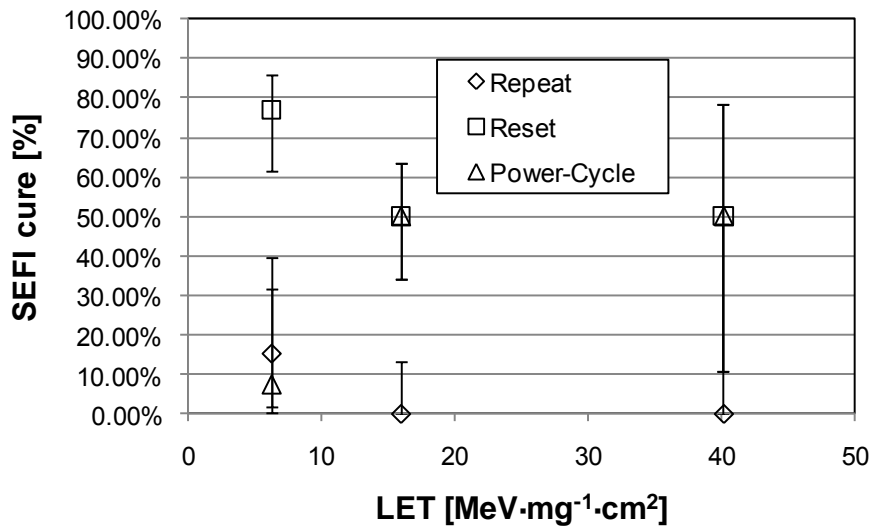

Figure 14: Actions needed to restore the device functionality after buffer program errors. Error bars represent 95% confidence intervals, calculate using Poisson statistics.

5.2.3 Read Errors

Read errors occurred always in bursts of about 10 errors in memory locations with consecutive addresses. **Fig. 15** shows the cross section for read errors as compared to that of program SEFIs for Ar. The cross sections are very similar. No read errors were observed under proton irradiations.

5.2.4 Permanent Functional Failures

For samples 3E, 5E, and 6E, which all belonged to the same chip revision (rev. B), permanent functional failures occurred early during irradiations, even with the lighter ions. This kind of failure was not observed with rev. A chips. After such an event, program operations result in an error in the Status Register, regardless of the number of programmed cells. However, after a read operation following a program of all the cells, only few of the words (usually less than 10) do not store the correct value. The cross section for these events is reported in **Table 6**.

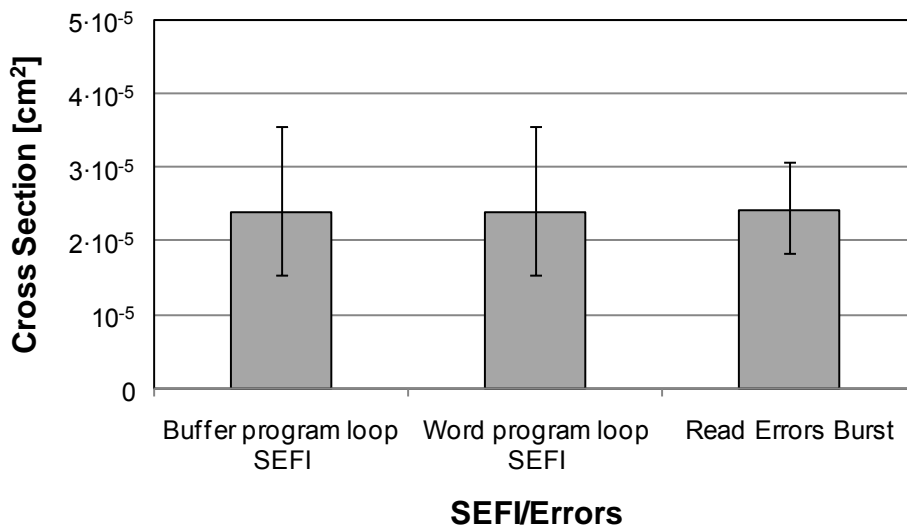

Figure 15: Read-errors burst cross section (Argon beam: E = 151 MeV, LET = 15.9 MeV·mg⁻¹·cm²), compared to Buffer program and Word program loop SEFI cross section. Error bars represent Poisson 95% confidence intervals.

The origin of these events is unknown at the moment, but appears to be related to some bugs in one revision of the chip (rev. B). This will probably not be an issue in future revisions of the chip, though this will have to be checked under heavy-ion irradiation.

No permanent functional failures were observed under proton irradiations.

Device	Ion species	LET in Si [MeV · cm ² /mg]	Cross section [cm ²]
3E	Ar	15.9	5.0E-05
5E	Ar	15.9	7.9E-05
6E	N	3.3	3.9E-07

Table 6: Permanent functional failures.

5.3 Error-rate Calculations

Cremer96 has been used to calculate error rates (**Table 7**) in the following three orbits:

- 1) International Space Station (ISS) orbit
- 2) PROBA II orbit (LEO, perigee: 715.2 km, apogee: 735.1 km, inclination: 98.3 °)
- 3) Geosynchronous orbit.

Solar minimum, worst-day flare and peak 5 min flare have been used for the calculations. Error rates, in particular for latch-up are not negligible.

Orbit	ISS 51.6° 500 km	ISS 51.6° 500 km	ISS 51.6° 500 km	PROBA II 98.3° 715-735 km	PROBA II 98.3° 715-735 km	PROBA II 98.3° 715-735 km	GEO	GEO	GEO
Trapped protons	AP8min, avg flux			AP8min, avg flux					
Magnetic weather condition	quiet	quiet	quiet	quiet	quiet	quiet			
Solar conditions	solar min	flare, worst- day	flare, peak 5 minutes	solar min	flare, worst- day	flare, peak 5 minutes	solar min	flare, worst- day	flare, peak 5 minutes
Shielding	100 mils Al	100 mils Al	100 mils Al	100 mils Al	100 mils Al	100 mils Al	100 mils Al	100 mils Al	100 mils Al
Heavy-ion SEFI [s ⁻¹]	2.06E-10	8.18E-08	3.00E-07	6.16E-10	5.88E-07	2.18E-06	2.15E-09	2.71E-06	1.01E-05
Heavy-ion Latchup [s ⁻¹]	5.23E-10	2.41E-07	8.82E-07	1.62E-09	1.62E-06	6.00E-06	5.72E-09	7.36E-06	2.73E-05

Table 7: Error rate calculations.

6 Conclusions

A full evaluation of the radiation sensitivity of Numonyx Omneo P8P phase change non-volatile memories was carried out.

Concerning TID evaluation, one sample was tested with a gamma source and did not show any functional failure up to 700 krad(Si) (also after annealing following irradiation). 5 samples were irradiated with x rays and in all cases they did not display any functional failures before 1.6 Mrad(Si), with one still functional above 4 Mrad(Si).

Concerning SEE tests, 5 samples were irradiated with heavy ions. The devices exhibited latch-up in all operating conditions, single event functional interrupts to a minor extent, and bursts of read errors when exposed to heavy-ion beams. Minor permanent functional failures were also observed in one revision of the chips.

In spite of the very good total dose tolerance, single event latch-up may prevent these devices to be used in space, due to a non-negligible SEL rate.