

# TOTAL DOSE RADIATION TEST REPORT

ESA study: "Survey of Critical Components for 150 kRad Power Systems"

ESTEC Contract N° 22831/09/NL/AF refers



Contract extension up to 400 kRad as per CCN: ATGSP-CN-0004 IS. 3

## Final Report

<p><b>Part Type : 2N5154</b></p> <p><b>Package : TO-39</b></p> <p><b>Description : NPN Power Silicon Transistor</b></p> <p><b>Manufacturer : Microsemi</b></p>
--

Alter Technology Purchase Order N° ATGSP-TL-09-JC-CO-9 dated 11/27/2009

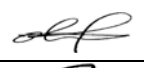
Alter Technology Project Manager: David NUNEZ

<b>Hirex reference :</b>	HRX/TID/1012	Issue : 01	Date :	January 23 <sup>rd</sup> , 2012
<b>Written by :</b>	G. VIDAL	Technician		
<b>Approved by :</b>	O.PERROTIN	Study Manager		
<b>Authorized by:</b>	J.F. PASCAL	Technical Director		



Hirex Engineering	Total Dose Radiation Test Report		Ref.:	HRX/TID/1012
	2N5154	Microsemi	Issue:	01

**TOTAL DOSE RADIATION TEST REPORT**  
**on**  
**Microsemi**  
**2N5154**  
**NPN Power Silicon Transistor**

**TABLE OF CONTENTS**

**1 INTRODUCTION.....4**

**2 APPLICABLE AND REFERENCE DOCUMENTS .....4**

    2.1 REFERENCE DOCUMENTS .....4

**3 TEST SAMPLES .....4**

**4 EXPERIMENTAL CONDITIONS.....6**

    4.1 RADIATION SOURCE DOSE RATE AND ANNEALING.....6

    4.2 BIAS DURING DOSE EXPOSURES AND MEASUREMENTS CONDITIONS.....7

        4.2.1 Bias conditions .....7

        4.2.2 Electrical Measurements .....7

**5 CONCLUSION.....9**

**6 TEST RESULTS.....10**

**LIST OF FIGURES:**

Figure 1 : Samples bias flow diagram.....4

Figure 2 : Bias Conditions during Irradiation Exposures .....7

Figure 3 : 2N5154 test program principle .....7

**LIST OF TABLES:**

Table 1 : Measured electrical parameters .....8

**LIST OF APPENDICES:**

Appendix 1: Temperature measurements on TID samples.....39

Hirex Engineering	Total Dose Radiation Test Report		Ref.:	HRX/TID/1012
	2N5154	Microsemi	Issue:	01

## 1 Introduction

In the scope of the ESA study: “Survey of Critical Components for 150 kRad Power Systems”, a total dose characterization test of the Microsemi 2N5154, NPN Power Silicon Transistor has been performed with an accumulated dose of about 396 Krad(Si) at different dose rates of 36, 100 and 300 rad(Si)/hour, in response to Alter Technology purchase order reference ATGSP-TL-09-JC-CO-9.

An Interim report, HRX/TID/0927 Issue 01, corresponding to the irradiation up to 162.9 Krad(Si) steps has been already provided.

The purpose of this test was to evaluate total dose withstanding of this component, to investigate its suitability for being used in space applications. This test was conducted on samples provided by Alter Technology.

Test has been performed in accordance with Hirex Engineering Radiation Test Plan HRX/SPE/0248 issue 1 dated 04/19/2011.

A complete set of electrical measurements together with graphical representation of measured parameters with respect to total dose received, are provided for all samples.

## 2 Applicable and Reference Documents

- Hirex Engineering Radiation Test Plan: HRX/SPE/0248 issue 1 dated 04/19/2011
- Alter Technology Proposal: ATGSP-OF-648/2009 Issue 1
- Minutes of Meeting: MM-SRP-ATG-0001 dated 29/10/2009
- Hirex internal specification: Total Ionizing dose test general procedure.
- MIL detail specification: MIL-PRF-19500/544G

### 2.1 Reference Documents

- Microsemi Corporation datasheet: T4-LDS-0039 Rev. 1 (080797)

## 3 Test Samples

13 samples of the 2N5154 device were tested (6 ON + 6 OFF + 1 control sample).

12 samples (including the 6 samples already submitted to protons test: see report HRX/TID/0919) have been biased according to the flow diagram given in Figure 1.

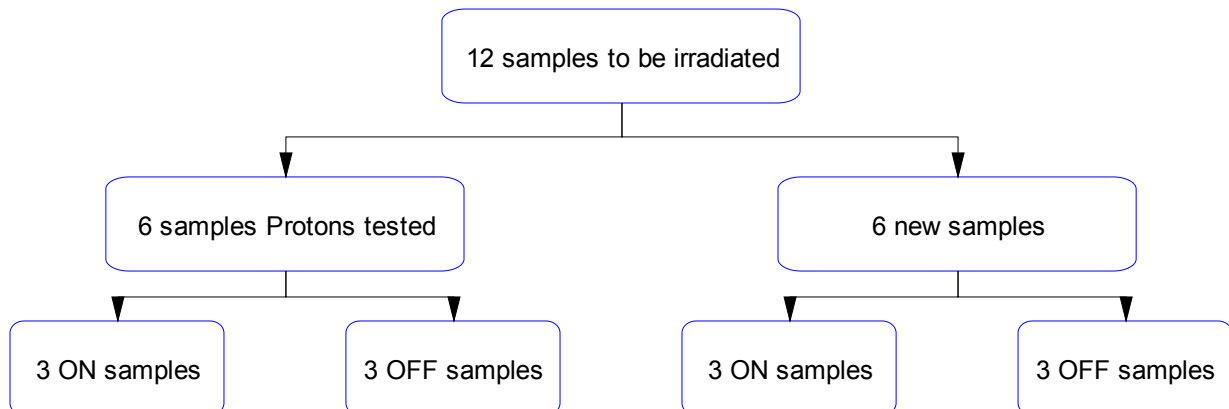

Figure 1 : Samples bias flow diagram

Hirex Engineering	Total Dose Radiation Test Report		Ref.:	HRX/TID/1012
	2N5154	Microsemi	Issue:	01

Samples were allocated into the bias conditions during exposures and annealing as provided in the following table. The different samples groups are also identified for an easier plots reading.

SN attributed by Hirex	Samples Allocation	Samples Group Naming
1	Control sample	REF
23	Biased ON	ON_PROTON
24	Biased ON	ON_PROTON
25	Biased ON	ON_PROTON
26	Biased OFF	OFF_PROTON
27	Biased OFF	OFF_PROTON
28	Biased OFF	OFF_PROTON
29	Biased ON	ON_TID
31	Biased ON	ON_TID
32	Biased ON	ON_TID
33	Biased OFF	OFF_TID
34	Biased OFF	OFF_TID
36	Biased OFF	OFF_TID

Identification of the 2N5154 is given below:

**Part Number:** 2N5154

**Top Marking:** MSC E1023 F2N5154

**Bottom Marking:** none

**Date Code:** 1023

Hirex Engineering	Total Dose Radiation Test Report		Ref.:	HRX/TID/1012
	2N5154	Microsemi	Issue:	01

## 4 Experimental Conditions

### 4.1 Radiation Source Dose Rate and Annealing

The dose exposures were performed at UCL in Louvain (Belgium). In this irradiation facility, a Cobalt 60 source is used with the possibility to vary the dose rate by simply adjusting the distance to the source. During the dose exposures, devices under test have been irradiated in an ambient temperature of 24°C ±6°C.

The dose received by the devices has been controlled by the measurement of one Alanine pellet dosimeter placed onto the bias board.

Resulting test conditions are provided below.

Irradiation Steps requested	Pellet dosimetry data	Dose rate	Annealing steps	Temperature
kRad	kRad	Rad/h	Hours	°C
0	0	0		Room
10	8.1	36		Room
20	22.5	36		Room
50	53.1	36		Room
100	108.9	36		Room
150	162.9	100 [1]		Room
200	204.3	300 [1]		Room
250	255.6	300 [1]		Room
300	305.1	300 [1]		Room
350	351	300 [1]		Room
400	396	300 [1]		Room
-	-	-	24	Room
-	-	-	168	100°C

Note [1]: Due to the maintenance period planned at UCL at the end of December and in order to perform subsequent requested exposures steps up to 400 Krad(Si), the dose rate of several steps have been changed, in agreement with ESA, from 36 rad(Si)/h to 100 rad(Si)/h and from 100 rad(Si)/h to 300 rad(Si)/h as indicated.

Hirex Engineering	Total Dose Radiation Test Report		Ref.:	HRX/TID/1012
	2N5154	Microsemi	Issue:	01

**4.2 Bias during Dose Exposures and Measurements conditions**

**4.2.1 Bias conditions**

During exposures test board allowed to bias 6 samples in accordance with the electrical circuit provided in Figure 2.  
 6 other samples were biased OFF with all pins connected to ground.

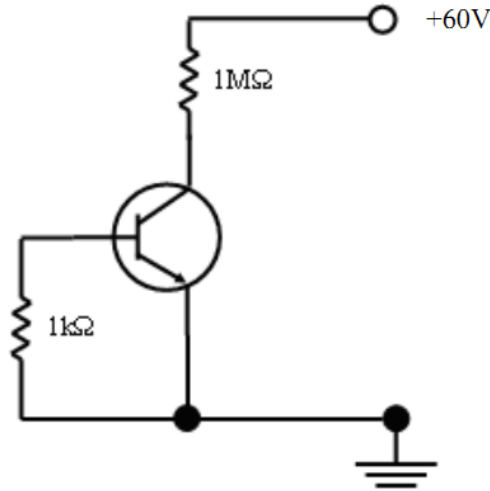

**Figure 2 : Bias Conditions during Irradiation Exposures**

**4.2.2 Electrical Measurements**

Electrical parameters test program principle for 2N5154 is provided in Figure 3.

A HP4142 DC tester and a network analyzer HP8714ES were used to perform required measurements.

A dedicated test fixture was designed to ensure proper measurement conditions. In addition a faraday cage was used to ensure optimum conditions for low level measurements.

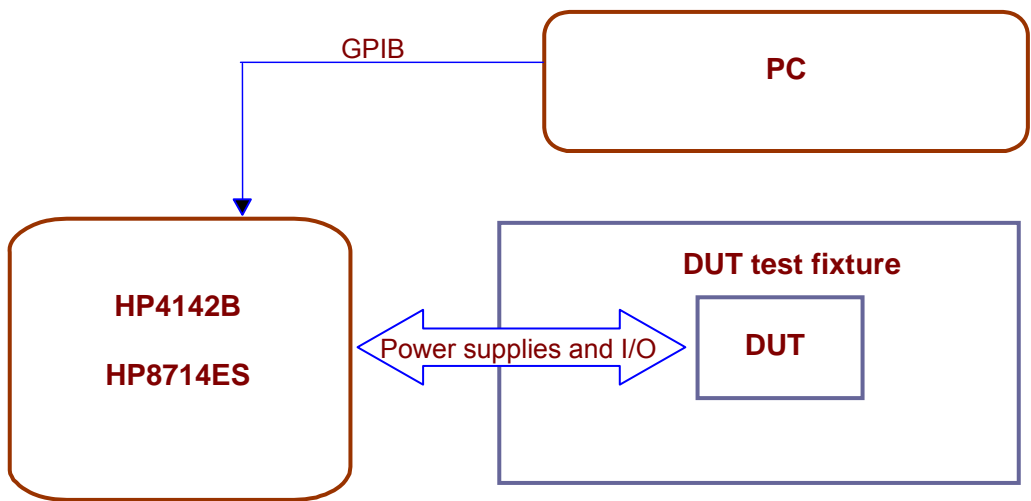

**Figure 3 : 2N5154 test program principle**

Hirex Engineering	Total Dose Radiation Test Report		Ref.:	HRX/TID/1012
	2N5154	Microsemi	Issue:	01

Electrical parameters test conditions and limits used for performing this test are given in Table 1.

Parameter	Description	Conditions	Spec		Unit
			Min	Max	
$I_{CES1}$	Collector-Emitter cut-off current	$V_{CE} = 60V, V_{BE} = 0V$	-	1	$\mu A$
$I_{CES2}$	Collector-Emitter cut-off current	$V_{CE} = 100V, V_{BE} = 0V$	-	1	mA
$I_{CEO}$	Collector-Emitter cut-off current	$V_{CE} = 40V, I_B = 0A$ Note 2	-	50	$\mu A$
$I_{EBO1}$	Emitter-Base cut-off current	$V_{EB} = 4V, I_C = 0A$	-	1	$\mu A$
$I_{EBO2}$	Emitter-Base cut-off current	$V_{EB} = 5.5V, I_C = 0A$	-	1	mA
$V_{(BR)CEO}$	Collector-Emitter breakdown voltage	$I_C = 100mA, \text{Note 1}$	80	-	V
$V_{CE(SAT)1}$	Collector-Emitter saturation voltage	$I_C = 2.5A, I_B = 250mA, \text{Note 1}$	-	0.75	V
$V_{CE(SAT)2}$	Collector-Emitter saturation voltage	$I_C = 5A, I_B = 500mA, \text{Note 1}$	-	1.5	V
$V_{BE(SAT)1}$	Base-Emitter saturation voltage	$I_C = 2.5A, I_B = 250mA, \text{Note 1}$	-	1.45	V
$V_{BE(SAT)2}$	Base-Emitter saturation voltage	$I_C = 5A, I_B = 500mA, \text{Note 1}$	-	2.2	V
$H_{FE1}$	Forward-current transfer ratio	$I_C = 50mA, V_{CE} = 5V, \text{Note 1}$	50	-	-
$H_{FE2}$	Forward-current transfer ratio	$I_C = 2.5A, V_{CE} = 5V, \text{Note 1}$	70	200	-
$H_{FE3}$	Forward-current transfer ratio	$I_C = 5A, V_{CE} = 5V, \text{Note 1}$	40	-	-
$F_T$	Gain Bandwidth Product	$V_{CE} = 5V, I_C = 0.5A$	70	-	MHz

Note 1 - Pulse measurement: Pulse Width  $\leq 300\mu s$ , duty cycle 1%.

Note 2 - This parameter has been measured at Room temperature at all steps of testing, and also at 110°C at initial step and after Annealing. No limit applicable at 110°C.

**Table 1 : Measured electrical parameters**



Hirex Engineering	Total Dose Radiation Test Report		Ref.:	HRX/TID/1012
	2N5154	Microsemi	Issue:	01

## 5 Conclusion

A Total Ionizing Dose characterization test was carried out by Hirex Engineering under Alter Technology contract on the Microsemi 2N5154 NPN Power Silicon Transistor in TO-39 package.

12 samples plus one control sample were used during testing. They were exposed to radiation using different dose rates of 36, 100 & 300 rad(Si)/hour at room temperature.

Initial and final measurements on some parameters at Low and high temperatures are provided in Appendix 1.

A summary of the failed parameters is provided in the following table. The behavior of each parameter is recorded for both biased On and biased Off samples.

Parameters not listed remained within specification limits all along testing or had no limits specified. Detail test results are presented in next section.

Parameters	Failure Level between :		Annealing Recovery [Note 1]					Comments
			NA	No	Partial	Complete	Rebound	
HFE1	ON_PROTON samples	-		X				[Note 2]
	ON_TID samples	0 & 8.1 kRad(Si)		X				
	OFF_POTON samples	-		X				[Note 2]
	OFF_TID samples	0 & 8.1 kRad(Si)		X				
HFE2	ON_PROTON samples	0 & 8.1 kRad(Si)		X				
	ON_TID samples	0 & 8.1 kRad(Si)		X				
	OFF_POTON samples	-		X				[Note 2]
	OFF_TID samples	22.5 & 53.1 kRad(Si)		X				
FT	ON_PROTON samples	-						[Note 3]
	ON_TID samples	-						[Note 3]
	OFF_POTON samples	-						[Note 3]
	OFF_TID samples	-						[Note 3]

[Note 1]: **NA** = Not applicable, **No**: means no sample has recovered, **Partial**: means at least one sample has recovered, **Complete**: means all samples have recovered, **Rebound**: means rebound has been observed on at least one sample.

[Note 2]: Samples failed after protons exposures were still failed at initial measurements of TID testing.

[Note 3]: Gain Bandwidth Product parameter FT was found below minimum specification limit at initial measurements step. However no significant drift was observed on this parameter during testing.

Hirex Engineering	Total Dose Radiation Test Report		Ref.:	HRX/TID/1012
	2N5154	Microsemi	Issue:	01

## 6 Test Results

Test results including tables and graphics are provided in this section for each measured parameter.

Statistics are provided separately for biased ON & biased OFF samples of each group.

For each parameter, a drift calculation table is provided computing the drift between a given exposure step with respect to initial readings:

$$\Delta(\text{Parameter value}) = (\text{Parameter value}_{\text{POSTRAD}}) - (\text{Parameter value}_{\text{PRERAD}})$$

For the particular case of transistors, drift calculation table for Hfe parameters will refer to 1/Hfe:

$$\Delta(1/hFE) = (1/hFE_{\text{POSTRAD}}) - (1/hFE_{\text{PRERAD}})$$

Parameter : Collector-Emitter Cut-Off Current : ICES1

Test conditions : VCE=60V. VBE=0V

Unit : A

Spec Limit Max : 1.0E-06

Spec limits are represented in bold lines on the graphic.

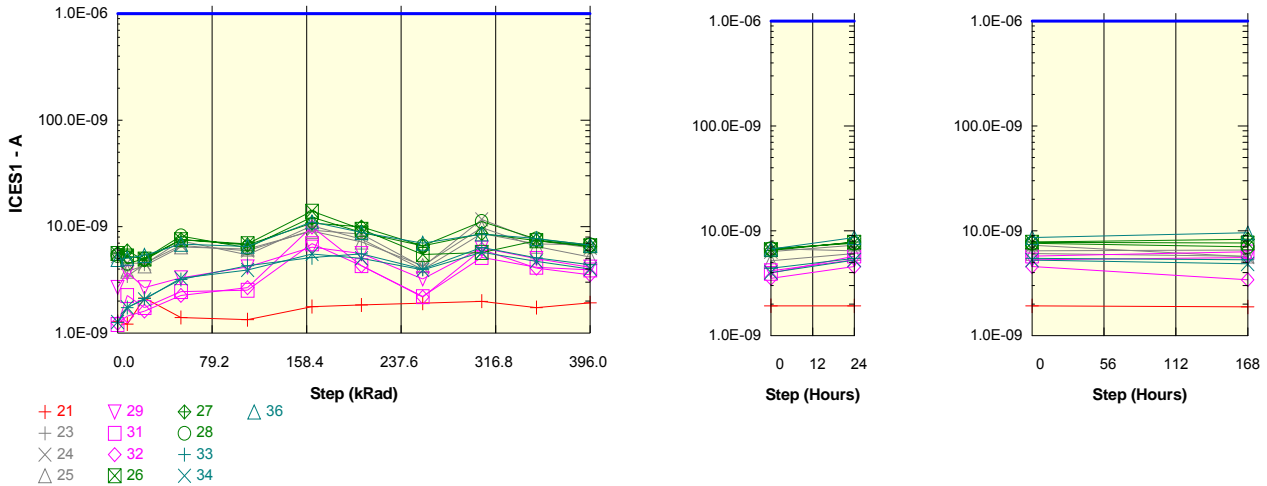

Measurements

ICES1	0 kRad	8.1 kRad	22.5 kRad	53.1 kRad	108.9 kRad	162.9 kRad	204.3 kRad	255.6 kRad	305.1 kRad	351 kRad	396 kRad	24 Hours	168 Hours
21_REF	1.3E-09	1.2E-09	2.1E-09	1.4E-09	1.3E-09	1.8E-09	1.8E-09	1.9E-09	2.0E-09	1.7E-09	1.9E-09	1.9E-09	1.9E-09
ON PROTON samples													
23	5.6E-09	3.4E-09	4.4E-09	7.3E-09	5.5E-09	10.2E-09	7.6E-09	4.0E-09	8.6E-09	6.9E-09	6.7E-09	6.5E-09	6.6E-09
24	5.3E-09	4.6E-09	4.5E-09	6.7E-09	5.9E-09	9.3E-09	8.5E-09	4.2E-09	11.7E-09	7.4E-09	6.3E-09	7.3E-09	5.6E-09
25	5.6E-09	3.8E-09	4.3E-09	6.5E-09	6.2E-09	9.1E-09	7.2E-09	4.3E-09	9.8E-09	6.5E-09	5.2E-09	6.1E-09	5.7E-09
Statistics													
Min	5.3E-09	3.4E-09	4.3E-09	6.5E-09	5.5E-09	9.1E-09	7.2E-09	4.0E-09	8.6E-09	6.5E-09	5.2E-09	6.1E-09	5.6E-09
Max	5.6E-09	4.6E-09	4.5E-09	7.3E-09	6.2E-09	10.2E-09	8.5E-09	4.3E-09	11.7E-09	7.4E-09	6.7E-09	7.3E-09	6.6E-09
Average	5.5E-09	3.9E-09	4.4E-09	6.8E-09	5.9E-09	9.5E-09	7.8E-09	4.2E-09	10.0E-09	6.9E-09	6.1E-09	6.6E-09	6.0E-09
Sigma	162.0E-12	471.9E-12	90.3E-12	379.5E-12	294.6E-12	488.8E-12	546.8E-12	145.9E-12	1.3E-09	363.5E-12	660.1E-12	510.4E-12	418.7E-12

Drift Calculation

ICES1	0 kRad	8.1 kRad	22.5 kRad	53.1 kRad	108.9 kRad	162.9 kRad	204.3 kRad	255.6 kRad	305.1 kRad	351 kRad	396 kRad	24 Hours	168 Hours
ON PROTON samples													
23	-	-2.2E-09	-1.2E-09	1.7E-09	-172.2E-12	4.6E-09	2.0E-09	-1.7E-09	3.0E-09	1.3E-09	1.1E-09	840.0E-12	938.2E-12
24	-	-707.4E-12	-770.0E-12	1.4E-09	666.6E-12	4.0E-09	3.2E-09	-1.1E-09	6.4E-09	2.1E-09	1.1E-09	2.0E-09	362.2E-12
25	-	-1.8E-09	-1.3E-09	838.6E-12	541.6E-12	3.4E-09	1.6E-09	-1.3E-09	4.2E-09	916.0E-12	-445.6E-12	457.8E-12	101.4E-12
Average	-	-1.6E-09	-1.1E-09	1.3E-09	345.3E-12	4.0E-09	2.3E-09	-1.4E-09	4.5E-09	1.4E-09	568.9E-12	1.1E-09	467.3E-12
Sigma	-	628.2E-12	235.8E-12	364.0E-12	369.5E-12	457.2E-12	700.7E-12	243.5E-12	1.4E-09	515.0E-12	717.6E-12	665.2E-12	349.6E-12

Measurements

ICES1	0 kRad	8.1 kRad	22.5 kRad	53.1 kRad	108.9 kRad	162.9 kRad	204.3 kRad	255.6 kRad	305.1 kRad	351 kRad	396 kRad	24 Hours	168 Hours
21_REF	1.3E-09	1.2E-09	2.1E-09	1.4E-09	1.3E-09	1.8E-09	1.8E-09	1.9E-09	2.0E-09	1.7E-09	1.9E-09	1.9E-09	1.9E-09
ON TID samples													
29	2.7E-09	3.7E-09	2.7E-09	3.3E-09	4.2E-09	6.4E-09	5.6E-09	3.2E-09	6.3E-09	5.0E-09	4.2E-09	5.3E-09	5.6E-09
31	1.2E-09	2.3E-09	1.7E-09	2.5E-09	2.5E-09	6.9E-09	4.3E-09	2.2E-09	5.1E-09	4.2E-09	3.9E-09	5.7E-09	6.3E-09
32	1.2E-09	1.4E-09	1.6E-09	2.3E-09	2.7E-09	9.9E-09	4.3E-09	2.2E-09	6.1E-09	4.1E-09	3.5E-09	4.6E-09	3.4E-09
Statistics													
Min	1.2E-09	1.4E-09	1.6E-09	2.3E-09	2.5E-09	6.4E-09	4.3E-09	2.2E-09	5.1E-09	4.1E-09	3.5E-09	4.6E-09	3.4E-09
Max	2.7E-09	3.7E-09	2.7E-09	3.3E-09	4.2E-09	9.9E-09	5.6E-09	3.2E-09	6.3E-09	5.0E-09	4.2E-09	5.7E-09	6.3E-09
Average	1.7E-09	2.5E-09	2.0E-09	2.7E-09	3.1E-09	7.8E-09	4.7E-09	2.5E-09	5.9E-09	4.4E-09	3.9E-09	5.2E-09	5.1E-09
Sigma	690.3E-12	932.1E-12	475.2E-12	451.3E-12	746.1E-12	1.6E-09	606.1E-12	489.4E-12	507.6E-12	419.3E-12	262.0E-12	484.8E-12	1.2E-09

Drift Calculation

ICES1	0 kRad	8.1 kRad	22.5 kRad	53.1 kRad	108.9 kRad	162.9 kRad	204.3 kRad	255.6 kRad	305.1 kRad	351 kRad	396 kRad	24 Hours	168 Hours
ON TID samples													
29	-	1.0E-09	-11.4E-12	617.2E-12	1.5E-09	3.7E-09	2.9E-09	544.6E-12	3.6E-09	2.3E-09	1.5E-09	2.6E-09	2.9E-09
31	-	1.0E-09	534.0E-12	1.3E-09	1.3E-09	5.7E-09	3.1E-09	999.2E-12	3.9E-09	3.0E-09	2.7E-09	4.5E-09	5.1E-09
32	-	210.0E-12	368.4E-12	1.0E-09	1.4E-09	8.7E-09	3.1E-09	942.2E-12	4.9E-09	2.9E-09	2.3E-09	3.3E-09	2.2E-09
Average	-	757.9E-12	297.0E-12	964.5E-12	1.4E-09	6.1E-09	3.0E-09	828.7E-12	4.1E-09	2.7E-09	2.2E-09	3.5E-09	3.4E-09
Sigma	-	387.6E-12	228.3E-12	262.1E-12	71.6E-12	2.0E-09	85.1E-12	202.2E-12	533.0E-12	275.6E-12	513.9E-12	796.8E-12	1.2E-09

Hirex Engineering	Total Dose Radiation Test Report								Ref.:	HRX/TID/1012			
	2N5154				Microsemi				Issue:	01			

**Measurements**

ICES1	0 kRad	8.1 kRad	22.5 kRad	53.1 kRad	108.9 kRad	162.9 kRad	204.3 kRad	255.6 kRad	305.1 kRad	351 kRad	396 kRad	24 Hours	168 Hours
21_REF	1.3E-09	1.2E-09	2.1E-09	1.4E-09	1.3E-09	1.8E-09	1.8E-09	1.9E-09	2.0E-09	1.7E-09	1.9E-09	1.9E-09	1.9E-09
OFF POTON samples													
26	5.6E-09	5.3E-09	5.0E-09	7.6E-09	6.9E-09	14.0E-09	9.5E-09	5.5E-09	5.7E-09	7.4E-09	6.6E-09	7.8E-09	7.7E-09
27	5.6E-09	5.9E-09	4.9E-09	7.6E-09	6.8E-09	10.8E-09	9.9E-09	6.6E-09	8.6E-09	7.4E-09	6.5E-09	7.8E-09	8.3E-09
28	5.4E-09	4.5E-09	5.0E-09	8.2E-09	6.4E-09	12.2E-09	8.8E-09	6.6E-09	11.2E-09	7.7E-09	6.8E-09	7.6E-09	7.0E-09
Statistics													
Min	5.4E-09	4.5E-09	4.9E-09	7.6E-09	6.4E-09	10.8E-09	8.8E-09	5.5E-09	5.7E-09	7.4E-09	6.5E-09	7.6E-09	7.0E-09
Max	5.6E-09	5.9E-09	5.0E-09	8.2E-09	6.9E-09	14.0E-09	9.9E-09	6.6E-09	11.2E-09	7.7E-09	6.8E-09	7.8E-09	8.3E-09
Average	5.5E-09	5.2E-09	4.9E-09	7.8E-09	6.7E-09	12.4E-09	9.4E-09	6.2E-09	8.5E-09	7.5E-09	6.6E-09	7.7E-09	7.7E-09
Sigma	121.5E-12	570.8E-12	56.8E-12	291.1E-12	233.0E-12	1.3E-09	468.5E-12	518.5E-12	2.2E-09	128.4E-12	118.6E-12	98.8E-12	517.4E-12

**Drift Calculation**

ICES1	0 kRad	8.1 kRad	22.5 kRad	53.1 kRad	108.9 kRad	162.9 kRad	204.3 kRad	255.6 kRad	305.1 kRad	351 kRad	396 kRad	24 Hours	168 Hours
OFF POTON samples													
26	-	-293.8E-12	-626.4E-12	2.0E-09	1.3E-09	8.4E-09	3.9E-09	-116.0E-12	130.6E-12	1.8E-09	1.0E-09	2.2E-09	2.1E-09
27	-	269.0E-12	-791.2E-12	1.9E-09	1.1E-09	5.2E-09	4.3E-09	937.2E-12	3.0E-09	1.7E-09	832.8E-12	2.2E-09	2.7E-09
28	-	-847.6E-12	-390.0E-12	2.8E-09	985.2E-12	6.9E-09	3.4E-09	1.2E-09	5.8E-09	2.3E-09	1.4E-09	2.2E-09	1.7E-09
Average	-	-290.8E-12	-602.5E-12	2.2E-09	1.1E-09	6.8E-09	3.9E-09	678.5E-12	3.0E-09	1.9E-09	1.1E-09	2.2E-09	2.1E-09
Sigma	-	455.8E-12	164.7E-12	411.6E-12	133.2E-12	1.3E-09	352.7E-12	573.1E-12	2.3E-09	249.1E-12	236.9E-12	25.4E-12	406.7E-12

**Measurements**

ICES1	0 kRad	8.1 kRad	22.5 kRad	53.1 kRad	108.9 kRad	162.9 kRad	204.3 kRad	255.6 kRad	305.1 kRad	351 kRad	396 kRad	24 Hours	168 Hours
21_REF	1.3E-09	1.2E-09	2.1E-09	1.4E-09	1.3E-09	1.8E-09	1.8E-09	1.9E-09	2.0E-09	1.7E-09	1.9E-09	1.9E-09	1.9E-09
OFF TID samples													
33	1.3E-09	1.7E-09	2.1E-09	3.2E-09	4.3E-09	5.1E-09	5.6E-09	4.0E-09	6.4E-09	5.1E-09	4.4E-09	5.5E-09	5.3E-09
34	1.3E-09	1.7E-09	2.1E-09	3.3E-09	3.9E-09	5.5E-09	5.0E-09	3.9E-09	5.7E-09	4.7E-09	4.0E-09	5.3E-09	4.8E-09
36	4.9E-09	5.1E-09	5.4E-09	6.8E-09	6.5E-09	11.1E-09	8.8E-09	7.0E-09	8.6E-09	7.7E-09	6.7E-09	8.6E-09	9.6E-09
Statistics													
Min	1.3E-09	1.7E-09	2.1E-09	3.2E-09	3.9E-09	5.1E-09	5.0E-09	3.9E-09	5.7E-09	4.7E-09	4.0E-09	5.3E-09	4.8E-09
Max	4.9E-09	5.1E-09	5.4E-09	6.8E-09	6.5E-09	11.1E-09	8.8E-09	7.0E-09	8.6E-09	7.7E-09	6.7E-09	8.6E-09	9.6E-09
Average	2.5E-09	2.8E-09	3.2E-09	4.4E-09	4.9E-09	7.3E-09	6.5E-09	5.0E-09	6.9E-09	5.8E-09	5.0E-09	6.5E-09	6.6E-09
Sigma	1.7E-09	1.6E-09	1.5E-09	1.7E-09	1.2E-09	2.7E-09	1.7E-09	1.4E-09	1.2E-09	1.3E-09	1.2E-09	1.5E-09	2.1E-09

**Drift Calculation**

ICES1	0 kRad	8.1 kRad	22.5 kRad	53.1 kRad	108.9 kRad	162.9 kRad	204.3 kRad	255.6 kRad	305.1 kRad	351 kRad	396 kRad	24 Hours	168 Hours
OFF TID samples													
33	-	473.2E-12	853.4E-12	1.9E-09	3.0E-09	3.9E-09	4.3E-09	2.7E-09	5.1E-09	3.8E-09	3.1E-09	4.2E-09	4.0E-09
34	-	474.4E-12	797.0E-12	2.0E-09	2.6E-09	4.3E-09	3.8E-09	2.7E-09	4.5E-09	3.4E-09	2.7E-09	4.0E-09	3.6E-09
36	-	149.2E-12	468.2E-12	1.9E-09	1.6E-09	6.2E-09	3.9E-09	2.1E-09	3.6E-09	2.8E-09	1.8E-09	3.7E-09	4.7E-09
Average	-	365.6E-12	706.2E-12	2.0E-09	2.4E-09	4.8E-09	4.0E-09	2.5E-09	4.4E-09	3.4E-09	2.5E-09	4.0E-09	4.1E-09
Sigma	-	153.0E-12	169.9E-12	36.8E-12	591.4E-12	1.0E-09	225.0E-12	291.8E-12	604.4E-12	421.6E-12	561.5E-12	206.8E-12	447.9E-12

Hirex Engineering	Total Dose Radiation Test Report		Ref.:	HRX/TID/1012
	2N5154	Microsemi	Issue:	01

Parameter : Collector-Emitter Cut-Off Current : ICES2

Test conditions : VCE=100V. VBE=0V

Unit : A

Spec Limit Max : 1.0E-03

Spec limits are represented in bold lines on the graphic.

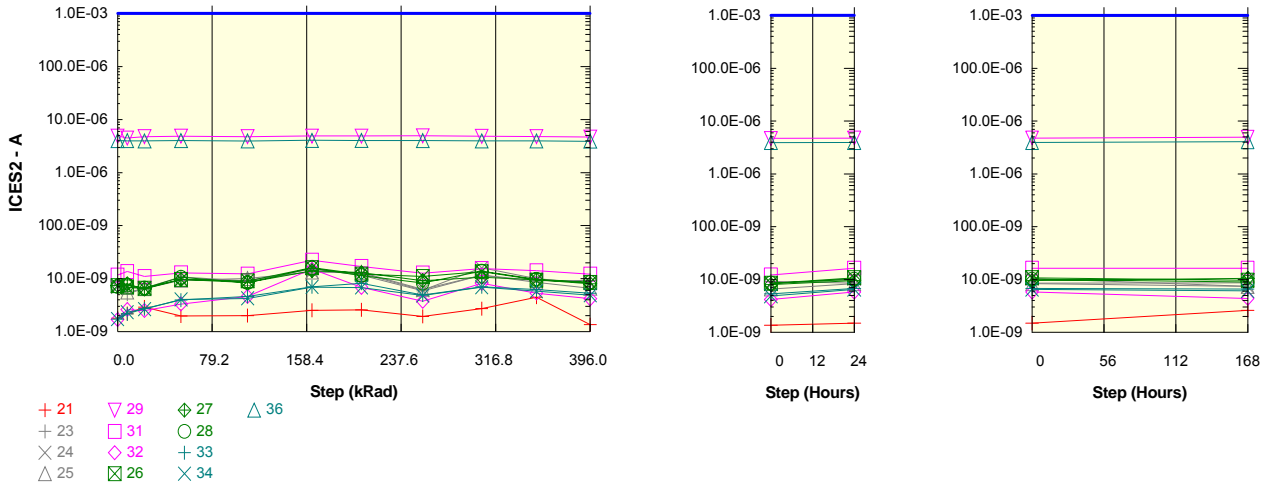

Measurements

ICES2	0 kRad	8.1 kRad	22.5 kRad	53.1 kRad	108.9 kRad	162.9 kRad	204.3 kRad	255.6 kRad	305.1 kRad	351 kRad	396 kRad	24 Hours	168 Hours
21_REF	1.8E-09	2.2E-09	2.9E-09	2.0E-09	2.0E-09	2.5E-09	2.6E-09	1.9E-09	2.7E-09	4.5E-09	1.4E-09	1.5E-09	2.6E-09
ON PROTON samples													
23	7.5E-09	5.1E-09	6.6E-09	10.8E-09	9.0E-09	15.3E-09	11.7E-09	5.9E-09	11.6E-09	9.2E-09	9.3E-09	8.6E-09	8.6E-09
24	7.0E-09	6.7E-09	6.6E-09	9.5E-09	9.3E-09	13.7E-09	12.6E-09	6.1E-09	15.9E-09	9.9E-09	8.2E-09	10.4E-09	7.4E-09
25	7.4E-09	5.6E-09	6.5E-09	9.4E-09	10.1E-09	13.4E-09	13.2E-09	6.3E-09	11.6E-09	8.6E-09	6.6E-09	8.3E-09	7.4E-09
Statistics													
Min	7.0E-09	5.1E-09	6.5E-09	9.4E-09	9.0E-09	13.4E-09	11.7E-09	5.9E-09	11.6E-09	8.6E-09	6.6E-09	8.3E-09	7.4E-09
Max	7.5E-09	6.7E-09	6.6E-09	10.8E-09	10.1E-09	15.3E-09	13.2E-09	6.3E-09	15.9E-09	9.9E-09	9.3E-09	10.4E-09	8.6E-09
Average	7.3E-09	5.8E-09	6.6E-09	9.9E-09	9.5E-09	14.1E-09	12.5E-09	6.1E-09	13.0E-09	9.2E-09	8.0E-09	9.1E-09	7.8E-09
Sigma	230.9E-12	659.5E-12	63.9E-12	634.3E-12	442.9E-12	854.4E-12	622.6E-12	174.9E-12	2.0E-09	553.3E-12	1.1E-09	919.6E-12	574.6E-12

Drift Calculation

ICES2	0 kRad	8.1 kRad	22.5 kRad	53.1 kRad	108.9 kRad	162.9 kRad	204.3 kRad	255.6 kRad	305.1 kRad	351 kRad	396 kRad	24 Hours	168 Hours
ON PROTON samples													
23	-	-2.4E-09	-907.2E-12	3.3E-09	1.5E-09	7.8E-09	4.2E-09	-1.6E-09	4.1E-09	1.7E-09	1.8E-09	1.1E-09	1.1E-09
24	-	-295.8E-12	-405.4E-12	2.5E-09	2.3E-09	6.7E-09	5.6E-09	-925.6E-12	8.9E-09	3.0E-09	1.3E-09	3.4E-09	419.0E-12
25	-	-1.8E-09	-944.8E-12	2.0E-09	2.7E-09	6.0E-09	5.8E-09	-1.1E-09	4.2E-09	1.2E-09	-811.2E-12	930.8E-12	-2.0E-12
Average	-	-1.5E-09	-752.5E-12	2.6E-09	2.1E-09	6.8E-09	5.2E-09	-1.2E-09	5.7E-09	1.9E-09	732.7E-12	1.8E-09	506.9E-12
Sigma	-	889.5E-12	245.9E-12	534.3E-12	480.4E-12	756.3E-12	728.9E-12	307.0E-12	2.3E-09	750.7E-12	1.1E-09	1.1E-09	455.6E-12

Measurements

ICES2	0 kRad	8.1 kRad	22.5 kRad	53.1 kRad	108.9 kRad	162.9 kRad	204.3 kRad	255.6 kRad	305.1 kRad	351 kRad	396 kRad	24 Hours	168 Hours
21_REF	1.8E-09	2.2E-09	2.9E-09	2.0E-09	2.0E-09	2.5E-09	2.6E-09	1.9E-09	2.7E-09	4.5E-09	1.4E-09	1.5E-09	2.6E-09
ON TID samples													
29	4.9E-06	4.5E-06	4.8E-06	4.9E-06	4.8E-06	4.9E-06	4.9E-06	4.9E-06	4.8E-06	4.8E-06	4.7E-06	4.7E-06	4.9E-06
31	11.7E-09	13.7E-09	11.0E-09	12.9E-09	12.3E-09	22.3E-09	16.9E-09	12.8E-09	15.5E-09	14.1E-09	12.2E-09	16.4E-09	16.4E-09
32	1.7E-09	2.6E-09	2.5E-09	3.3E-09	4.6E-09	15.1E-09	6.8E-09	3.7E-09	8.2E-09	5.3E-09	4.2E-09	5.8E-09	4.4E-09
Statistics													
Min	1.7E-09	2.6E-09	2.5E-09	3.3E-09	4.6E-09	15.1E-09	6.8E-09	3.7E-09	8.2E-09	5.3E-09	4.2E-09	5.8E-09	4.4E-09
Max	4.9E-06	4.5E-06	4.8E-06	4.9E-06	4.8E-06	4.9E-06	4.9E-06	4.9E-06	4.8E-06	4.8E-06	4.7E-06	4.7E-06	4.9E-06
Average	1.6E-06	1.5E-06	1.6E-06	1.6E-06	1.6E-06	1.6E-06	1.6E-06	1.7E-06	1.6E-06	1.6E-06	1.6E-06	1.6E-06	1.7E-06
Sigma	2.3E-06	2.1E-06	2.2E-06	2.3E-06	2.2E-06	2.3E-06	2.3E-06	2.3E-06	2.3E-06	2.3E-06	2.2E-06	2.2E-06	2.3E-06

Drift Calculation

ICES2	0 kRad	8.1 kRad	22.5 kRad	53.1 kRad	108.9 kRad	162.9 kRad	204.3 kRad	255.6 kRad	305.1 kRad	351 kRad	396 kRad	24 Hours	168 Hours
ON TID samples													
29	-	-423.8E-09	-133.4E-09	-39.6E-09	-137.6E-09	6.8E-09	-8.0E-09	56.6E-09	-45.6E-09	-105.6E-09	-202.2E-09	-149.2E-09	52.8E-09
31	-	1.9E-09	-746.0E-12	1.1E-09	542.0E-12	10.6E-09	5.2E-09	1.0E-09	3.8E-09	2.4E-09	486.0E-12	4.7E-09	4.7E-09
32	-	920.0E-12	811.2E-12	1.6E-09	2.9E-09	13.4E-09	5.1E-09	2.1E-09	6.5E-09	3.6E-09	2.5E-09	4.1E-09	2.7E-09
Average	-	-140.3E-09	-44.4E-09	-12.3E-09	-44.7E-09	10.2E-09	771.9E-12	19.9E-09	-11.8E-09	-33.2E-09	-66.4E-09	-46.8E-09	20.1E-09
Sigma	-	200.5E-09	62.9E-09	19.3E-09	65.7E-09	2.7E-09	6.2E-09	26.0E-09	23.9E-09	51.2E-09	96.0E-09	72.4E-09	23.2E-09

Hirex Engineering	Total Dose Radiation Test Report									Ref.:	HRX/TID/1012		
	2N5154					Microsemi				Issue:	01		

**Measurements**

ICES2	0 kRad	8.1 kRad	22.5 kRad	53.1 kRad	108.9 kRad	162.9 kRad	204.3 kRad	255.6 kRad	305.1 kRad	351 kRad	396 kRad	24 Hours	168 Hours
21_REF	1.8E-09	2.2E-09	2.9E-09	2.0E-09	2.0E-09	2.5E-09	2.6E-09	1.9E-09	2.7E-09	4.5E-09	1.4E-09	1.5E-09	2.6E-09
OFF POTON samples													
26	7.4E-09	7.0E-09	6.6E-09	9.7E-09	9.1E-09	16.1E-09	12.2E-09	11.0E-09	13.5E-09	9.4E-09	8.5E-09	10.8E-09	9.7E-09
27	7.5E-09	7.9E-09	6.4E-09	9.6E-09	8.5E-09	14.0E-09	12.9E-09	9.2E-09	10.7E-09	9.5E-09	8.0E-09	9.5E-09	10.6E-09
28	7.1E-09	7.6E-09	6.6E-09	10.6E-09	8.4E-09	15.9E-09	11.4E-09	8.3E-09	13.8E-09	9.7E-09	8.5E-09	10.1E-09	8.9E-09
Statistics													
Min	7.1E-09	7.0E-09	6.4E-09	9.6E-09	8.4E-09	14.0E-09	11.4E-09	8.3E-09	10.7E-09	9.4E-09	8.0E-09	9.5E-09	8.9E-09
Max	7.5E-09	7.9E-09	6.6E-09	10.6E-09	9.1E-09	16.1E-09	12.9E-09	11.0E-09	13.8E-09	9.7E-09	8.5E-09	10.8E-09	10.6E-09
Average	7.3E-09	7.5E-09	6.5E-09	10.0E-09	8.6E-09	15.3E-09	12.2E-09	9.5E-09	12.7E-09	9.6E-09	8.3E-09	10.1E-09	9.7E-09
Sigma	131.3E-12	396.2E-12	81.7E-12	459.8E-12	296.0E-12	924.8E-12	616.5E-12	1.1E-09	1.4E-09	132.8E-12	224.4E-12	531.6E-12	677.1E-12

**Drift Calculation**

ICES2	0 kRad	8.1 kRad	22.5 kRad	53.1 kRad	108.9 kRad	162.9 kRad	204.3 kRad	255.6 kRad	305.1 kRad	351 kRad	396 kRad	24 Hours	168 Hours
OFF POTON samples													
26	-	-398.4E-12	-789.0E-12	2.3E-09	1.7E-09	8.7E-09	4.8E-09	3.6E-09	6.1E-09	2.1E-09	1.1E-09	3.5E-09	2.3E-09
27	-	467.0E-12	-1.0E-09	2.2E-09	1.0E-09	6.6E-09	5.5E-09	1.7E-09	3.2E-09	2.1E-09	551.8E-12	2.1E-09	3.1E-09
28	-	422.2E-12	-548.6E-12	3.5E-09	1.2E-09	8.7E-09	4.3E-09	1.1E-09	6.7E-09	2.6E-09	1.3E-09	3.0E-09	1.8E-09
Average	-	163.6E-12	-794.3E-12	2.7E-09	1.3E-09	8.0E-09	4.8E-09	2.2E-09	5.3E-09	2.2E-09	1.0E-09	2.8E-09	2.4E-09
Sigma	-	397.8E-12	202.8E-12	588.2E-12	272.7E-12	1.0E-09	489.1E-12	1.1E-09	1.5E-09	251.8E-12	328.5E-12	577.2E-12	552.0E-12

**Measurements**

ICES2	0 kRad	8.1 kRad	22.5 kRad	53.1 kRad	108.9 kRad	162.9 kRad	204.3 kRad	255.6 kRad	305.1 kRad	351 kRad	396 kRad	24 Hours	168 Hours
21_REF	1.8E-09	2.2E-09	2.9E-09	2.0E-09	2.0E-09	2.5E-09	2.6E-09	1.9E-09	2.7E-09	4.5E-09	1.4E-09	1.5E-09	2.6E-09
OFF TID samples													
33	1.7E-09	2.2E-09	2.7E-09	4.0E-09	4.6E-09	7.0E-09	8.2E-09	4.9E-09	7.0E-09	6.2E-09	5.3E-09	6.8E-09	6.6E-09
34	1.7E-09	2.3E-09	2.7E-09	4.1E-09	4.2E-09	6.9E-09	6.8E-09	4.8E-09	6.9E-09	5.8E-09	4.9E-09	6.5E-09	6.1E-09
36	4.0E-06	4.0E-06	4.0E-06	4.0E-06	3.9E-06	4.1E-06	4.0E-06	4.0E-06	4.0E-06	4.0E-06	3.9E-06	3.9E-06	4.1E-06
Statistics													
Min	1.7E-09	2.2E-09	2.7E-09	4.0E-09	4.2E-09	6.9E-09	6.8E-09	4.8E-09	6.9E-09	5.8E-09	4.9E-09	6.5E-09	6.1E-09
Max	4.0E-06	4.0E-06	4.0E-06	4.0E-06	3.9E-06	4.1E-06	4.0E-06	4.0E-06	4.0E-06	4.0E-06	3.9E-06	3.9E-06	4.1E-06
Average	1.3E-06	1.3E-06	1.3E-06	1.3E-06	1.3E-06	1.4E-06	1.3E-06	1.3E-06	1.3E-06	1.3E-06	1.3E-06	1.3E-06	1.4E-06
Sigma	1.9E-06	1.9E-06	1.9E-06	1.9E-06	1.9E-06	1.9E-06	1.9E-06	1.9E-06	1.9E-06	1.9E-06	1.8E-06	1.9E-06	1.9E-06

**Drift Calculation**

ICES2	0 kRad	8.1 kRad	22.5 kRad	53.1 kRad	108.9 kRad	162.9 kRad	204.3 kRad	255.6 kRad	305.1 kRad	351 kRad	396 kRad	24 Hours	168 Hours
OFF TID samples													
33	-	431.6E-12	1.0E-09	2.2E-09	2.9E-09	5.3E-09	6.5E-09	3.2E-09	5.3E-09	4.5E-09	3.6E-09	5.1E-09	4.8E-09
34	-	608.8E-12	944.8E-12	2.3E-09	2.5E-09	5.2E-09	5.1E-09	3.1E-09	5.2E-09	4.1E-09	3.2E-09	4.8E-09	4.4E-09
36	-	-32.8E-09	-53.4E-09	200.1E-12	-77.6E-09	50.6E-09	13.8E-09	-5.8E-09	-42.6E-09	-43.2E-09	-110.2E-09	-80.6E-09	51.2E-09
Average	-	-10.6E-09	-17.2E-09	1.6E-09	-24.1E-09	20.4E-09	8.5E-09	164.4E-12	-10.7E-09	-11.5E-09	-34.5E-09	-23.6E-09	20.1E-09
Sigma	-	15.7E-09	25.6E-09	986.0E-12	37.9E-09	21.4E-09	3.8E-09	4.2E-09	22.6E-09	22.4E-09	53.5E-09	40.3E-09	22.0E-09

Parameter : Collector-Emitter Cut-Off Current : ICEO

Test conditions : VCE=40V. IB=0A

Unit : A

Spec Limit Max : 50.0E-06

Spec limits are represented in bold lines on the graphic.

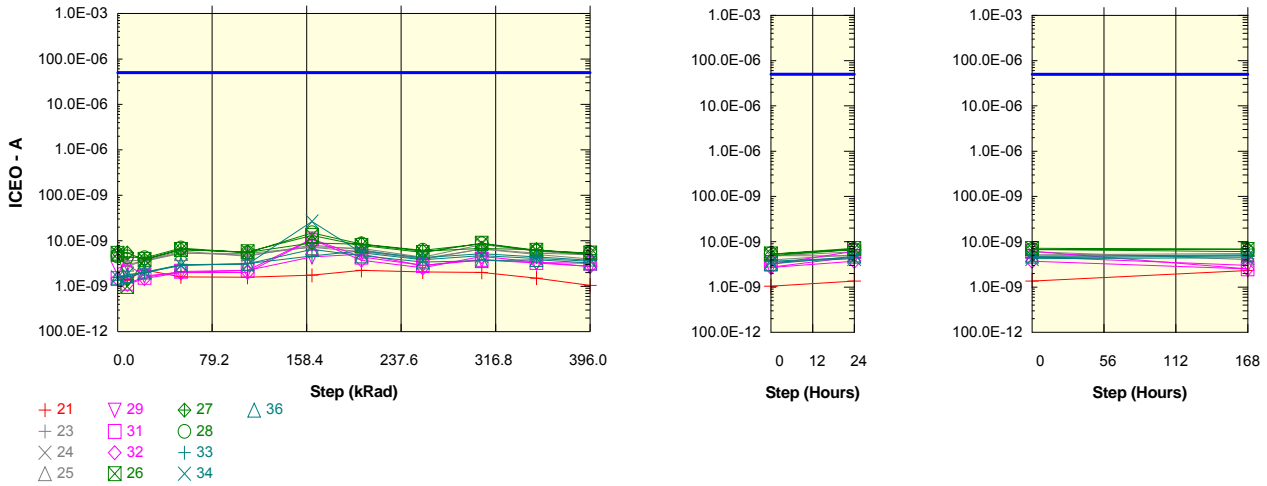

Measurements

ICEO	0 kRad	8.1 kRad	22.5 kRad	53.1 kRad	108.9 kRad	162.9 kRad	204.3 kRad	255.6 kRad	305.1 kRad	351 kRad	396 kRad	24 Hours	168 Hours
21 REF	1.6E-09	1.4E-09	2.3E-09	1.6E-09	1.6E-09	1.7E-09	2.2E-09	2.1E-09	2.0E-09	1.5E-09	1.0E-09	1.4E-09	2.3E-09
ON PROTON samples													
23	5.4E-09	2.8E-09	3.7E-09	5.9E-09	4.6E-09	8.1E-09	6.4E-09	3.9E-09	6.6E-09	5.3E-09	5.0E-09	4.9E-09	4.9E-09
24	5.1E-09	3.7E-09	3.7E-09	5.5E-09	4.8E-09	7.4E-09	6.8E-09	4.4E-09	8.3E-09	5.9E-09	4.8E-09	6.0E-09	4.0E-09
25	5.4E-09	3.0E-09	3.5E-09	5.3E-09	5.3E-09	7.1E-09	5.8E-09	4.1E-09	6.6E-09	5.0E-09	4.0E-09	5.2E-09	5.5E-09
Statistics													
Min	5.1E-09	2.8E-09	3.5E-09	5.3E-09	4.6E-09	7.1E-09	5.8E-09	3.9E-09	6.6E-09	5.0E-09	4.0E-09	4.9E-09	4.0E-09
Max	5.4E-09	3.7E-09	3.7E-09	5.9E-09	5.3E-09	8.1E-09	6.8E-09	4.4E-09	8.3E-09	5.9E-09	5.0E-09	6.0E-09	5.5E-09
Average	5.3E-09	3.2E-09	3.6E-09	5.6E-09	4.9E-09	7.5E-09	6.3E-09	4.1E-09	7.2E-09	5.4E-09	4.6E-09	5.4E-09	4.8E-09
Sigma	157.5E-12	379.3E-12	65.0E-12	277.5E-12	293.4E-12	396.3E-12	441.8E-12	197.4E-12	802.7E-12	376.0E-12	443.0E-12	471.8E-12	582.3E-12

Drift Calculation

ICEO	0 kRad	8.1 kRad	22.5 kRad	53.1 kRad	108.9 kRad	162.9 kRad	204.3 kRad	255.6 kRad	305.1 kRad	351 kRad	396 kRad	24 Hours	168 Hours
ON PROTON samples													
23	-	-2.6E-09	-1.7E-09	547.8E-12	-816.8E-12	2.7E-09	1.0E-09	-1.5E-09	1.2E-09	-46.6E-12	-418.2E-12	-488.4E-12	-438.2E-12
24	-	-1.4E-09	-1.4E-09	416.2E-12	-239.6E-12	2.3E-09	1.8E-09	-683.2E-12	3.3E-09	880.8E-12	-230.0E-12	947.0E-12	-1.0E-09
25	-	-2.3E-09	-1.8E-09	-136.4E-12	-127.2E-12	1.8E-09	369.2E-12	-1.3E-09	1.2E-09	-366.8E-12	-1.4E-09	-225.8E-12	56.8E-12
Average	-	-2.1E-09	-1.6E-09	275.9E-12	-394.5E-12	2.3E-09	1.1E-09	-1.2E-09	1.9E-09	155.8E-12	-695.4E-12	77.6E-12	-463.5E-12
Sigma	-	528.9E-12	207.0E-12	296.4E-12	302.1E-12	389.2E-12	578.8E-12	343.0E-12	960.0E-12	529.1E-12	530.7E-12	624.0E-12	435.6E-12

Measurements

ICEO	0 kRad	8.1 kRad	22.5 kRad	53.1 kRad	108.9 kRad	162.9 kRad	204.3 kRad	255.6 kRad	305.1 kRad	351 kRad	396 kRad	24 Hours	168 Hours
21 REF	1.6E-09	1.4E-09	2.3E-09	1.6E-09	1.6E-09	1.7E-09	2.2E-09	2.1E-09	2.0E-09	1.5E-09	1.0E-09	1.4E-09	2.3E-09
ON TID samples													
29	2.5E-09	3.0E-09	1.7E-09	2.0E-09	2.2E-09	4.4E-09	5.0E-09	2.8E-09	3.8E-09	3.2E-09	2.7E-09	4.6E-09	3.0E-09
31	1.5E-09	1.2E-09	1.6E-09	2.1E-09	2.2E-09	11.0E-09	4.4E-09	2.9E-09	3.9E-09	3.3E-09	3.2E-09	6.2E-09	2.5E-09
32	1.5E-09	1.1E-09	1.5E-09	2.0E-09	2.0E-09	10.7E-09	3.7E-09	2.5E-09	4.5E-09	3.4E-09	2.7E-09	3.7E-09	2.5E-09
Statistics													
Min	1.5E-09	1.1E-09	1.5E-09	2.0E-09	2.0E-09	4.4E-09	3.7E-09	2.5E-09	3.8E-09	3.2E-09	2.7E-09	3.7E-09	2.5E-09
Max	2.5E-09	3.0E-09	1.7E-09	2.1E-09	2.2E-09	11.0E-09	5.0E-09	2.9E-09	4.5E-09	3.4E-09	3.2E-09	6.2E-09	3.0E-09
Average	1.8E-09	1.8E-09	1.6E-09	2.0E-09	2.2E-09	8.7E-09	4.4E-09	2.8E-09	4.1E-09	3.3E-09	2.9E-09	4.8E-09	2.7E-09
Sigma	474.0E-12	880.6E-12	85.6E-12	60.7E-12	101.4E-12	3.1E-09	531.2E-12	156.8E-12	317.3E-12	71.1E-12	227.0E-12	1.0E-09	227.0E-12

Drift Calculation

ICEO	0 kRad	8.1 kRad	22.5 kRad	53.1 kRad	108.9 kRad	162.9 kRad	204.3 kRad	255.6 kRad	305.1 kRad	351 kRad	396 kRad	24 Hours	168 Hours
ON TID samples													
29	-	528.0E-12	-787.6E-12	-455.8E-12	-249.6E-12	1.9E-09	2.6E-09	373.6E-12	1.3E-09	752.6E-12	273.8E-12	2.2E-09	514.0E-12
31	-	-316.8E-12	82.8E-12	643.0E-12	766.0E-12	9.5E-09	2.9E-09	1.4E-09	2.4E-09	1.9E-09	1.7E-09	4.7E-09	1.0E-09
32	-	-351.2E-12	21.6E-12	524.8E-12	565.4E-12	9.2E-09	2.3E-09	1.1E-09	3.1E-09	1.9E-09	1.3E-09	2.3E-09	1.0E-09
Average	-	-46.7E-12	-227.7E-12	237.3E-12	360.6E-12	6.9E-09	2.6E-09	949.9E-12	2.3E-09	1.5E-09	1.1E-09	3.0E-09	863.5E-12
Sigma	-	406.6E-12	396.7E-12	492.5E-12	439.2E-12	3.5E-09	259.2E-12	428.3E-12	713.7E-12	540.7E-12	607.1E-12	1.2E-09	247.2E-12

Hirex Engineering	Total Dose Radiation Test Report									Ref.:	HRX/TID/1012
	2N5154			Microsemi						Issue:	01

**Measurements**

ICEO	0 kRad	8.1 kRad	22.5 kRad	53.1 kRad	108.9 kRad	162.9 kRad	204.3 kRad	255.6 kRad	305.1 kRad	351 kRad	396 kRad	24 Hours	168 Hours
21_REF	1.6E-09	1.4E-09	2.3E-09	1.6E-09	1.6E-09	1.7E-09	2.2E-09	2.1E-09	2.0E-09	1.5E-09	1.0E-09	1.4E-09	2.3E-09
OFF POTON samples													
26	5.3E-09	989.0E-12	3.9E-09	6.4E-09	5.7E-09	13.2E-09	7.9E-09	5.5E-09	8.8E-09	6.2E-09	5.4E-09	7.1E-09	6.8E-09
27	5.6E-09	5.4E-09	3.8E-09	6.5E-09	5.5E-09	8.9E-09	8.4E-09	5.9E-09	6.8E-09	6.4E-09	4.9E-09	6.7E-09	6.9E-09
28	4.6E-09	4.5E-09	4.2E-09	6.9E-09	5.5E-09	15.0E-09	8.5E-09	6.2E-09	8.6E-09	6.0E-09	5.3E-09	6.8E-09	6.0E-09
Statistics													
Min	4.6E-09	989.0E-12	3.8E-09	6.4E-09	5.5E-09	8.9E-09	7.9E-09	5.5E-09	6.8E-09	6.0E-09	4.9E-09	6.7E-09	6.0E-09
Max	5.6E-09	5.4E-09	4.2E-09	6.9E-09	5.7E-09	15.0E-09	8.5E-09	6.2E-09	8.8E-09	6.4E-09	5.4E-09	7.1E-09	6.9E-09
Average	5.2E-09	3.6E-09	4.0E-09	6.6E-09	5.6E-09	12.4E-09	8.3E-09	5.9E-09	8.1E-09	6.2E-09	5.2E-09	6.9E-09	6.6E-09
Sigma	426.2E-12	1.9E-09	162.1E-12	227.0E-12	117.4E-12	2.5E-09	271.2E-12	271.5E-12	883.7E-12	166.8E-12	194.9E-12	184.2E-12	384.2E-12

**Drift Calculation**

ICEO	0 kRad	8.1 kRad	22.5 kRad	53.1 kRad	108.9 kRad	162.9 kRad	204.3 kRad	255.6 kRad	305.1 kRad	351 kRad	396 kRad	24 Hours	168 Hours
OFF POTON samples													
26	-	-4.3E-09	-1.4E-09	1.1E-09	403.6E-12	7.9E-09	2.6E-09	205.0E-12	3.5E-09	894.6E-12	49.2E-12	1.8E-09	1.5E-09
27	-	-209.8E-12	-1.8E-09	889.4E-12	-66.8E-12	3.4E-09	2.8E-09	350.4E-12	1.2E-09	799.6E-12	-640.8E-12	1.1E-09	1.3E-09
28	-	-131.0E-12	-387.8E-12	2.3E-09	869.0E-12	10.4E-09	3.9E-09	1.6E-09	4.0E-09	1.4E-09	766.4E-12	2.2E-09	1.5E-09
Average	-	-1.6E-09	-1.2E-09	1.4E-09	401.9E-12	7.2E-09	3.1E-09	720.3E-12	2.9E-09	1.0E-09	58.3E-12	1.7E-09	1.4E-09
Sigma	-	2.0E-09	588.3E-12	642.7E-12	382.0E-12	2.9E-09	593.3E-12	628.8E-12	1.2E-09	263.3E-12	574.5E-12	436.4E-12	69.3E-12

**Measurements**

ICEO	0 kRad	8.1 kRad	22.5 kRad	53.1 kRad	108.9 kRad	162.9 kRad	204.3 kRad	255.6 kRad	305.1 kRad	351 kRad	396 kRad	24 Hours	168 Hours
21_REF	1.6E-09	1.4E-09	2.3E-09	1.6E-09	1.6E-09	1.7E-09	2.2E-09	2.1E-09	2.0E-09	1.5E-09	1.0E-09	1.4E-09	2.3E-09
OFF TID samples													
33	1.4E-09	1.6E-09	2.0E-09	2.8E-09	3.1E-09	4.6E-09	6.0E-09	4.3E-09	5.2E-09	4.4E-09	3.7E-09	4.5E-09	4.9E-09
34	1.6E-09	1.8E-09	2.0E-09	3.0E-09	3.0E-09	26.7E-09	5.5E-09	3.8E-09	4.7E-09	4.1E-09	3.5E-09	4.2E-09	4.4E-09
36	1.6E-09	1.7E-09	2.1E-09	3.0E-09	3.1E-09	6.5E-09	4.7E-09	3.4E-09	3.7E-09	3.8E-09	3.3E-09	4.8E-09	5.2E-09
Statistics													
Min	1.4E-09	1.6E-09	2.0E-09	2.8E-09	3.0E-09	4.6E-09	4.7E-09	3.4E-09	3.7E-09	3.8E-09	3.3E-09	4.2E-09	4.4E-09
Max	1.6E-09	1.8E-09	2.1E-09	3.0E-09	3.1E-09	26.7E-09	6.0E-09	4.3E-09	5.2E-09	4.4E-09	3.7E-09	4.8E-09	5.2E-09
Average	1.5E-09	1.7E-09	2.0E-09	2.9E-09	3.1E-09	12.6E-09	5.4E-09	3.8E-09	4.5E-09	4.1E-09	3.5E-09	4.5E-09	4.8E-09
Sigma	101.5E-12	94.7E-12	40.0E-12	57.6E-12	52.2E-12	10.0E-09	536.3E-12	342.2E-12	651.4E-12	232.6E-12	193.9E-12	221.4E-12	293.9E-12

**Drift Calculation**

ICEO	0 kRad	8.1 kRad	22.5 kRad	53.1 kRad	108.9 kRad	162.9 kRad	204.3 kRad	255.6 kRad	305.1 kRad	351 kRad	396 kRad	24 Hours	168 Hours
OFF TID samples													
33	-	233.6E-12	632.0E-12	1.5E-09	1.8E-09	3.3E-09	4.6E-09	2.9E-09	3.9E-09	3.0E-09	2.4E-09	3.1E-09	3.5E-09
34	-	252.2E-12	382.4E-12	1.4E-09	1.5E-09	25.1E-09	3.9E-09	2.2E-09	3.1E-09	2.5E-09	2.0E-09	2.7E-09	2.9E-09
36	-	148.6E-12	474.2E-12	1.4E-09	1.5E-09	4.9E-09	3.1E-09	1.8E-09	2.1E-09	2.3E-09	1.7E-09	3.2E-09	3.6E-09
Average	-	211.5E-12	496.2E-12	1.4E-09	1.6E-09	11.1E-09	3.9E-09	2.3E-09	3.0E-09	2.6E-09	2.0E-09	3.0E-09	3.3E-09
Sigma	-	45.1E-12	103.1E-12	44.2E-12	141.1E-12	9.9E-09	620.0E-12	434.5E-12	732.6E-12	326.0E-12	282.8E-12	235.2E-12	318.4E-12



Parameter : Emitter-Base Cut-Off Current : IEBO1

Test conditions : VEB=4V, IC=0A

Unit : A

Spec Limit Max : 1.0E-06

Spec limits are represented in bold lines on the graphic.

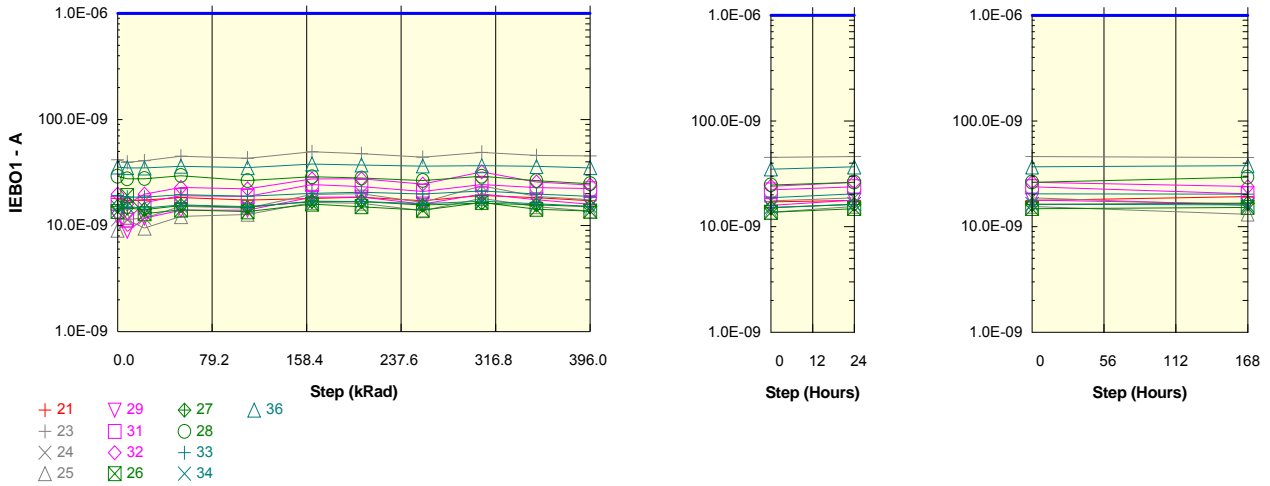

Measurements

IEBO1	0 kRad	8.1 kRad	22.5 kRad	53.1 kRad	108.9 kRad	162.9 kRad	204.3 kRad	255.6 kRad	305.1 kRad	351 kRad	396 kRad	24 Hours	168 Hours
21 REF	18.1E-09	17.2E-09	17.4E-09	18.4E-09	17.5E-09	18.1E-09	18.6E-09	17.1E-09	19.3E-09	18.4E-09	17.1E-09	17.7E-09	19.3E-09
ON PROTON samples													
23	41.7E-09	39.6E-09	40.8E-09	45.1E-09	43.3E-09	49.7E-09	47.6E-09	44.1E-09	49.0E-09	45.8E-09	45.3E-09	46.2E-09	45.2E-09
24	11.5E-09	11.4E-09	11.8E-09	15.2E-09	14.6E-09	19.6E-09	20.0E-09	16.5E-09	23.8E-09	18.8E-09	17.5E-09	18.7E-09	15.9E-09
25	9.0E-09	11.3E-09	9.5E-09	12.2E-09	12.8E-09	16.5E-09	16.3E-09	13.8E-09	18.1E-09	15.1E-09	13.7E-09	15.6E-09	13.1E-09
Statistics													
Min	9.0E-09	11.3E-09	9.5E-09	12.2E-09	12.8E-09	16.5E-09	16.3E-09	13.8E-09	18.1E-09	15.1E-09	13.7E-09	15.6E-09	13.1E-09
Max	41.7E-09	39.6E-09	40.8E-09	45.1E-09	43.3E-09	49.7E-09	47.6E-09	44.1E-09	49.0E-09	45.8E-09	45.3E-09	46.2E-09	45.2E-09
Average	20.8E-09	20.8E-09	20.7E-09	24.2E-09	23.5E-09	28.6E-09	28.0E-09	24.8E-09	30.3E-09	26.6E-09	25.5E-09	26.8E-09	24.7E-09
Sigma	14.9E-09	13.3E-09	14.2E-09	14.9E-09	14.0E-09	15.0E-09	14.0E-09	13.7E-09	13.4E-09	13.7E-09	14.1E-09	13.8E-09	14.5E-09

Drift Calculation

IEBO1	0 kRad	8.1 kRad	22.5 kRad	53.1 kRad	108.9 kRad	162.9 kRad	204.3 kRad	255.6 kRad	305.1 kRad	351 kRad	396 kRad	24 Hours	168 Hours
ON PROTON samples													
23	-	-2.1E-09	-946.0E-12	3.4E-09	1.5E-09	8.0E-09	5.9E-09	2.4E-09	7.3E-09	4.1E-09	3.5E-09	4.5E-09	3.5E-09
24	-	-40.0E-12	336.0E-12	3.8E-09	3.1E-09	8.2E-09	8.6E-09	5.0E-09	12.3E-09	7.3E-09	6.1E-09	7.2E-09	4.4E-09
25	-	2.3E-09	413.6E-12	3.1E-09	3.7E-09	7.4E-09	7.2E-09	4.8E-09	9.1E-09	6.1E-09	4.6E-09	6.5E-09	4.1E-09
Average	-	43.3E-12	-65.5E-12	3.4E-09	2.8E-09	7.9E-09	7.2E-09	4.1E-09	9.6E-09	5.8E-09	4.7E-09	6.1E-09	4.0E-09
Sigma	-	1.8E-09	623.4E-12	253.1E-12	931.4E-12	317.0E-12	1.1E-09	1.2E-09	2.1E-09	1.3E-09	1.0E-09	1.2E-09	390.2E-12

Measurements

IEBO1	0 kRad	8.1 kRad	22.5 kRad	53.1 kRad	108.9 kRad	162.9 kRad	204.3 kRad	255.6 kRad	305.1 kRad	351 kRad	396 kRad	24 Hours	168 Hours
21_REF	18.1E-09	17.2E-09	17.4E-09	18.4E-09	17.5E-09	18.1E-09	18.6E-09	17.1E-09	19.3E-09	18.4E-09	17.1E-09	17.7E-09	19.3E-09
ON TID samples													
29	11.9E-09	8.8E-09	11.8E-09	14.0E-09	14.0E-09	18.5E-09	18.6E-09	16.0E-09	19.9E-09	17.5E-09	15.9E-09	17.9E-09	16.4E-09
31	16.3E-09	11.2E-09	16.5E-09	19.2E-09	18.9E-09	24.4E-09	23.3E-09	21.0E-09	24.4E-09	22.8E-09	22.3E-09	23.9E-09	20.5E-09
32	19.8E-09	16.0E-09	19.8E-09	22.9E-09	22.2E-09	27.5E-09	27.6E-09	24.6E-09	32.2E-09	25.8E-09	24.2E-09	26.4E-09	23.9E-09
Statistics													
Min	11.9E-09	8.8E-09	11.8E-09	14.0E-09	14.0E-09	18.5E-09	18.6E-09	16.0E-09	19.9E-09	17.5E-09	15.9E-09	17.9E-09	16.4E-09
Max	19.8E-09	16.0E-09	19.8E-09	22.9E-09	22.2E-09	27.5E-09	27.6E-09	24.6E-09	32.2E-09	25.8E-09	24.2E-09	26.4E-09	23.9E-09
Average	16.0E-09	12.0E-09	16.0E-09	18.7E-09	18.4E-09	23.5E-09	23.2E-09	20.6E-09	25.5E-09	22.0E-09	20.8E-09	22.7E-09	20.3E-09
Sigma	3.2E-09	3.0E-09	3.3E-09	3.7E-09	3.4E-09	3.7E-09	3.7E-09	3.5E-09	5.1E-09	3.4E-09	3.6E-09	3.6E-09	3.1E-09

Drift Calculation

IEBO1	0 kRad	8.1 kRad	22.5 kRad	53.1 kRad	108.9 kRad	162.9 kRad	204.3 kRad	255.6 kRad	305.1 kRad	351 kRad	396 kRad	24 Hours	168 Hours
ON TID samples													
29	-	-3.1E-09	-184.0E-12	2.1E-09	2.1E-09	6.6E-09	6.7E-09	4.1E-09	7.9E-09	5.6E-09	3.9E-09	5.9E-09	4.5E-09
31	-	-5.1E-09	190.0E-12	2.9E-09	2.6E-09	8.1E-09	7.0E-09	4.7E-09	8.1E-09	6.5E-09	6.0E-09	7.6E-09	4.1E-09
32	-	-3.8E-09	10.0E-12	3.1E-09	2.4E-09	7.7E-09	7.8E-09	4.8E-09	12.3E-09	5.9E-09	4.4E-09	6.5E-09	4.1E-09
Average	-	-4.0E-09	5.3E-12	2.7E-09	2.4E-09	7.5E-09	7.2E-09	4.5E-09	9.5E-09	6.0E-09	4.8E-09	6.7E-09	4.2E-09
Sigma	-	814.4E-12	152.7E-12	451.1E-12	204.5E-12	629.4E-12	467.4E-12	324.3E-12	2.0E-09	380.6E-12	886.0E-12	693.2E-12	165.1E-12

Hirex Engineering	Total Dose Radiation Test Report									Ref.:	HRX/TID/1012		
	2N5154					Microsemi				Issue:	01		

**Measurements**

IEBO1	0 kRad	8.1 kRad	22.5 kRad	53.1 kRad	108.9 kRad	162.9 kRad	204.3 kRad	255.6 kRad	305.1 kRad	351 kRad	396 kRad	24 Hours	168 Hours
21_REF	18.1E-09	17.2E-09	17.4E-09	18.4E-09	17.5E-09	18.1E-09	18.6E-09	17.1E-09	19.3E-09	18.4E-09	17.1E-09	17.7E-09	19.3E-09
OFF POTON samples													
26	13.6E-09	19.2E-09	13.0E-09	14.0E-09	13.5E-09	16.0E-09	15.1E-09	14.0E-09	16.5E-09	14.3E-09	13.7E-09	14.8E-09	15.2E-09
27	15.2E-09	14.7E-09	14.2E-09	15.5E-09	14.8E-09	17.0E-09	16.9E-09	15.6E-09	16.3E-09	15.7E-09	15.1E-09	16.2E-09	16.7E-09
28	29.2E-09	27.6E-09	27.7E-09	29.6E-09	26.6E-09	28.8E-09	28.1E-09	26.7E-09	29.2E-09	26.5E-09	24.8E-09	26.3E-09	29.4E-09
Statistics													
Min	13.6E-09	14.7E-09	13.0E-09	14.0E-09	13.5E-09	16.0E-09	15.1E-09	14.0E-09	16.3E-09	14.3E-09	13.7E-09	14.8E-09	15.2E-09
Max	29.2E-09	27.6E-09	27.7E-09	29.6E-09	26.6E-09	28.8E-09	28.1E-09	26.7E-09	29.2E-09	26.5E-09	24.8E-09	26.3E-09	29.4E-09
Average	19.3E-09	20.5E-09	18.3E-09	19.7E-09	18.3E-09	20.6E-09	20.0E-09	18.8E-09	20.7E-09	18.8E-09	17.9E-09	19.1E-09	20.4E-09
Sigma	7.0E-09	5.3E-09	6.7E-09	7.0E-09	5.9E-09	5.9E-09	5.8E-09	5.6E-09	6.0E-09	5.5E-09	4.9E-09	5.1E-09	6.4E-09

**Drift Calculation**

IEBO1	0 kRad	8.1 kRad	22.5 kRad	53.1 kRad	108.9 kRad	162.9 kRad	204.3 kRad	255.6 kRad	305.1 kRad	351 kRad	396 kRad	24 Hours	168 Hours
OFF POTON samples													
26	-	5.6E-09	-630.0E-12	460.0E-12	-66.0E-12	2.4E-09	1.5E-09	424.0E-12	2.9E-09	708.0E-12	108.0E-12	1.2E-09	1.6E-09
27	-	-486.0E-12	-1.0E-09	296.0E-12	-348.0E-12	1.8E-09	1.7E-09	432.0E-12	1.2E-09	516.0E-12	-70.0E-12	1.0E-09	1.5E-09
28	-	-1.6E-09	-1.6E-09	366.0E-12	-2.6E-09	-382.0E-12	-1.1E-09	-2.6E-09	-42.0E-12	-2.7E-09	-4.4E-09	-2.9E-09	182.0E-12
Average	-	1.2E-09	-1.1E-09	374.0E-12	-1.0E-09	1.3E-09	701.3E-12	-566.0E-12	1.4E-09	-494.0E-12	-1.5E-09	-208.7E-12	1.1E-09
Sigma	-	3.2E-09	381.0E-12	67.2E-12	1.1E-09	1.2E-09	1.3E-09	1.4E-09	1.2E-09	1.6E-09	2.1E-09	1.9E-09	659.1E-12

**Measurements**

IEBO1	0 kRad	8.1 kRad	22.5 kRad	53.1 kRad	108.9 kRad	162.9 kRad	204.3 kRad	255.6 kRad	305.1 kRad	351 kRad	396 kRad	24 Hours	168 Hours
21_REF	18.1E-09	17.2E-09	17.4E-09	18.4E-09	17.5E-09	18.1E-09	18.6E-09	17.1E-09	19.3E-09	18.4E-09	17.1E-09	17.7E-09	19.3E-09
OFF TID samples													
33	19.2E-09	18.6E-09	18.5E-09	19.6E-09	18.9E-09	20.2E-09	20.7E-09	19.9E-09	21.2E-09	19.8E-09	18.9E-09	20.4E-09	20.4E-09
34	15.0E-09	15.1E-09	14.6E-09	15.7E-09	15.1E-09	16.8E-09	16.8E-09	16.1E-09	16.9E-09	16.0E-09	15.2E-09	16.4E-09	16.0E-09
36	35.6E-09	35.1E-09	35.0E-09	36.2E-09	35.2E-09	38.1E-09	37.3E-09	36.4E-09	36.8E-09	36.2E-09	35.1E-09	36.7E-09	37.8E-09
Statistics													
Min	15.0E-09	15.1E-09	14.6E-09	15.7E-09	15.1E-09	16.8E-09	16.8E-09	16.1E-09	16.9E-09	16.0E-09	15.2E-09	16.4E-09	16.0E-09
Max	35.6E-09	35.1E-09	35.0E-09	36.2E-09	35.2E-09	38.1E-09	37.3E-09	36.4E-09	36.8E-09	36.2E-09	35.1E-09	36.7E-09	37.8E-09
Average	23.3E-09	22.9E-09	22.7E-09	23.8E-09	23.1E-09	25.0E-09	25.0E-09	24.1E-09	25.0E-09	24.0E-09	23.1E-09	24.5E-09	24.7E-09
Sigma	8.9E-09	8.7E-09	8.8E-09	8.9E-09	8.7E-09	9.4E-09	8.9E-09	8.8E-09	8.5E-09	8.7E-09	8.7E-09	8.8E-09	9.4E-09

**Drift Calculation**

IEBO1	0 kRad	8.1 kRad	22.5 kRad	53.1 kRad	108.9 kRad	162.9 kRad	204.3 kRad	255.6 kRad	305.1 kRad	351 kRad	396 kRad	24 Hours	168 Hours
OFF TID samples													
33	-	-626.0E-12	-688.0E-12	374.0E-12	-296.0E-12	956.0E-12	1.5E-09	690.0E-12	2.0E-09	632.0E-12	-332.0E-12	1.2E-09	1.1E-09
34	-	168.0E-12	-338.0E-12	746.0E-12	132.0E-12	1.9E-09	1.9E-09	1.1E-09	2.0E-09	1.1E-09	262.0E-12	1.4E-09	1.1E-09
36	-	-508.0E-12	-662.0E-12	612.0E-12	-466.0E-12	2.5E-09	1.7E-09	794.0E-12	1.2E-09	570.0E-12	-502.0E-12	1.1E-09	2.2E-09
Average	-	-322.0E-12	-562.7E-12	577.3E-12	-210.0E-12	1.8E-09	1.7E-09	875.3E-12	1.7E-09	766.7E-12	-190.7E-12	1.2E-09	1.5E-09
Sigma	-	349.8E-12	159.2E-12	153.8E-12	251.6E-12	637.8E-12	166.2E-12	193.3E-12	393.8E-12	235.7E-12	327.5E-12	138.9E-12	501.0E-12

Parameter : Emitter-Base Cut-Off Current : IEBO2

Test conditions : VEB=5.5V. IC=0A

Unit : A

Spec Limit Max : 1.0E-03

Spec limits are represented in bold lines on the graphic.

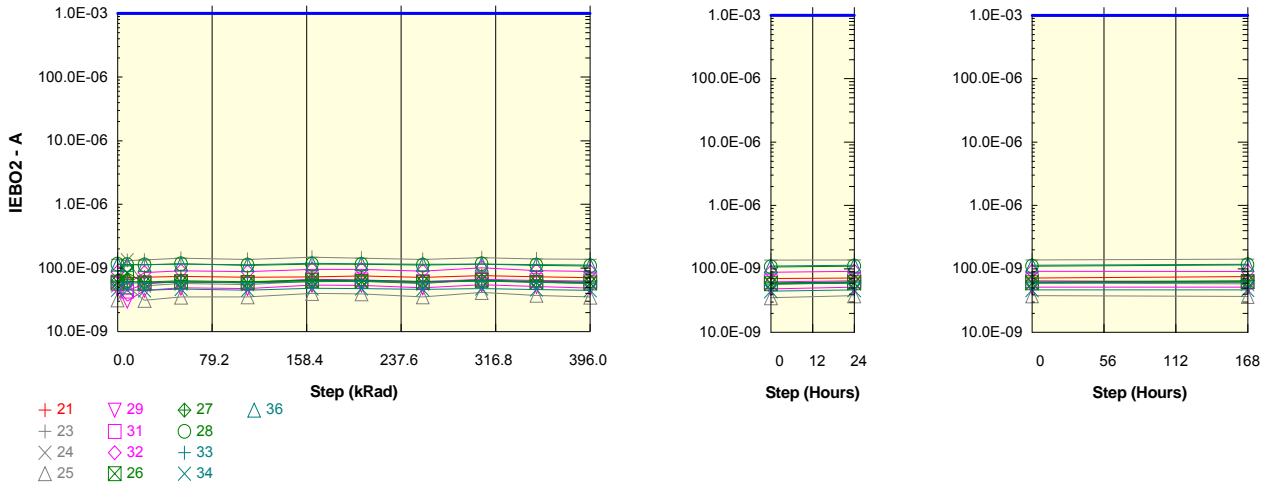

Measurements

IEBO2	0 kRad	8.1 kRad	22.5 kRad	53.1 kRad	108.9 kRad	162.9 kRad	204.3 kRad	255.6 kRad	305.1 kRad	351 kRad	396 kRad	24 Hours	168 Hours
21 REF	73.3E-09	70.5E-09	72.1E-09	73.5E-09	71.8E-09	72.7E-09	75.1E-09	71.2E-09	76.1E-09	73.1E-09	70.5E-09	72.1E-09	76.2E-09
ON PROTON samples													
23	137.8E-09	131.5E-09	133.9E-09	142.4E-09	136.7E-09	147.7E-09	143.3E-09	136.5E-09	144.9E-09	139.1E-09	137.6E-09	139.3E-09	142.3E-09
24	53.0E-09	133.5E-09	52.8E-09	56.9E-09	55.1E-09	61.9E-09	62.6E-09	56.6E-09	67.2E-09	60.3E-09	57.8E-09	59.6E-09	58.1E-09
25	31.6E-09	51.4E-09	31.1E-09	35.1E-09	35.2E-09	39.9E-09	39.4E-09	35.3E-09	41.3E-09	37.2E-09	35.0E-09	37.8E-09	36.7E-09
Statistics													
Min	31.6E-09	51.4E-09	31.1E-09	35.1E-09	35.2E-09	39.9E-09	39.4E-09	35.3E-09	41.3E-09	37.2E-09	35.0E-09	37.8E-09	36.7E-09
Max	137.8E-09	133.5E-09	133.9E-09	142.4E-09	136.7E-09	147.7E-09	143.3E-09	136.5E-09	144.9E-09	139.1E-09	137.6E-09	139.3E-09	142.3E-09
Average	74.1E-09	105.5E-09	72.6E-09	78.1E-09	75.7E-09	83.2E-09	81.8E-09	76.1E-09	84.5E-09	78.8E-09	76.8E-09	78.9E-09	79.0E-09
Sigma	45.9E-09	38.2E-09	44.2E-09	46.3E-09	43.9E-09	46.5E-09	44.6E-09	43.6E-09	44.0E-09	43.6E-09	44.0E-09	43.6E-09	45.6E-09

Drift Calculation

IEBO2	0 kRad	8.1 kRad	22.5 kRad	53.1 kRad	108.9 kRad	162.9 kRad	204.3 kRad	255.6 kRad	305.1 kRad	351 kRad	396 kRad	24 Hours	168 Hours
ON PROTON samples													
23	-	-6.3E-09	-3.9E-09	4.6E-09	-1.1E-09	9.9E-09	5.6E-09	-1.2E-09	7.1E-09	1.3E-09	-160.0E-12	1.6E-09	4.6E-09
24	-	80.5E-09	-284.0E-12	3.9E-09	2.1E-09	8.8E-09	9.5E-09	3.6E-09	14.2E-09	7.3E-09	4.8E-09	6.6E-09	5.0E-09
25	-	19.9E-09	-432.0E-12	3.6E-09	3.6E-09	8.3E-09	7.8E-09	3.7E-09	9.8E-09	5.6E-09	3.5E-09	6.2E-09	5.1E-09
Average	-	31.4E-09	-1.5E-09	4.0E-09	1.5E-09	9.0E-09	7.6E-09	2.0E-09	10.4E-09	4.7E-09	2.7E-09	4.8E-09	4.9E-09
Sigma	-	36.3E-09	1.7E-09	457.7E-12	2.0E-09	680.7E-12	1.6E-09	2.3E-09	2.9E-09	2.5E-09	2.1E-09	2.3E-09	243.5E-12

Measurements

IEBO2	0 kRad	8.1 kRad	22.5 kRad	53.1 kRad	108.9 kRad	162.9 kRad	204.3 kRad	255.6 kRad	305.1 kRad	351 kRad	396 kRad	24 Hours	168 Hours
21_REF	73.3E-09	70.5E-09	72.1E-09	73.5E-09	71.8E-09	72.7E-09	75.1E-09	71.2E-09	76.1E-09	73.1E-09	70.5E-09	72.1E-09	76.2E-09
ON TID samples													
29	46.6E-09	30.4E-09	44.6E-09	48.8E-09	47.7E-09	53.9E-09	53.7E-09	49.1E-09	54.8E-09	51.3E-09	48.6E-09	51.5E-09	51.8E-09
31	57.5E-09	43.8E-09	56.8E-09	61.0E-09	59.2E-09	67.0E-09	65.2E-09	61.3E-09	66.1E-09	63.6E-09	62.8E-09	65.2E-09	62.6E-09
32	86.5E-09	56.1E-09	85.1E-09	90.3E-09	87.5E-09	95.5E-09	95.4E-09	89.8E-09	101.0E-09	91.4E-09	88.3E-09	92.0E-09	91.4E-09
Statistics													
Min	46.6E-09	30.4E-09	44.6E-09	48.8E-09	47.7E-09	53.9E-09	53.7E-09	49.1E-09	54.8E-09	51.3E-09	48.6E-09	51.5E-09	51.8E-09
Max	86.5E-09	56.1E-09	85.1E-09	90.3E-09	87.5E-09	95.5E-09	95.4E-09	89.8E-09	101.0E-09	91.4E-09	88.3E-09	92.0E-09	91.4E-09
Average	63.5E-09	43.4E-09	62.1E-09	66.7E-09	64.8E-09	72.1E-09	71.4E-09	66.7E-09	74.0E-09	68.8E-09	66.6E-09	69.5E-09	68.6E-09
Sigma	16.9E-09	10.5E-09	16.9E-09	17.4E-09	16.7E-09	17.4E-09	17.5E-09	17.1E-09	19.7E-09	16.8E-09	16.4E-09	16.8E-09	16.7E-09

Drift Calculation

IEBO2	0 kRad	8.1 kRad	22.5 kRad	53.1 kRad	108.9 kRad	162.9 kRad	204.3 kRad	255.6 kRad	305.1 kRad	351 kRad	396 kRad	24 Hours	168 Hours
ON TID samples													
29	-	-16.2E-09	-1.9E-09	2.3E-09	1.1E-09	7.4E-09	7.2E-09	2.6E-09	8.3E-09	4.8E-09	2.1E-09	4.9E-09	5.3E-09
31	-	-13.7E-09	-708.0E-12	3.5E-09	1.7E-09	9.5E-09	7.7E-09	3.8E-09	8.6E-09	6.1E-09	5.4E-09	7.7E-09	5.1E-09
32	-	-30.5E-09	-1.5E-09	3.7E-09	940.0E-12	9.0E-09	8.8E-09	3.3E-09	14.5E-09	4.9E-09	1.8E-09	5.5E-09	4.9E-09
Average	-	-20.1E-09	-1.4E-09	3.2E-09	1.3E-09	8.6E-09	7.9E-09	3.2E-09	10.5E-09	5.3E-09	3.1E-09	6.0E-09	5.1E-09
Sigma	-	7.4E-09	501.4E-12	649.9E-12	328.0E-12	910.8E-12	684.9E-12	526.8E-12	2.9E-09	589.6E-12	1.6E-09	1.2E-09	136.9E-12

Hirex Engineering	Total Dose Radiation Test Report									Ref.:	HRX/TID/1012
	2N5154				Microsemi					Issue:	01

**Measurements**

IEBO2	0 kRad	8.1 kRad	22.5 kRad	53.1 kRad	108.9 kRad	162.9 kRad	204.3 kRad	255.6 kRad	305.1 kRad	351 kRad	396 kRad	24 Hours	168 Hours
21_REF	73.3E-09	70.5E-09	72.1E-09	73.5E-09	71.8E-09	72.7E-09	75.1E-09	71.2E-09	76.1E-09	73.1E-09	70.5E-09	72.1E-09	76.2E-09
OFF POTON samples													
26	60.1E-09	84.4E-09	58.2E-09	60.6E-09	59.0E-09	63.5E-09	61.7E-09	59.2E-09	63.9E-09	59.8E-09	58.5E-09	60.5E-09	62.8E-09
27	62.8E-09	61.4E-09	60.1E-09	62.9E-09	61.0E-09	64.8E-09	64.5E-09	61.7E-09	63.1E-09	61.8E-09	60.4E-09	62.3E-09	65.1E-09
28	115.3E-09	113.2E-09	112.1E-09	116.2E-09	110.6E-09	115.5E-09	114.2E-09	111.2E-09	115.8E-09	110.8E-09	107.8E-09	110.7E-09	115.8E-09
Statistics													
Min	60.1E-09	61.4E-09	58.2E-09	60.6E-09	59.0E-09	63.5E-09	61.7E-09	59.2E-09	63.1E-09	59.8E-09	58.5E-09	60.5E-09	62.8E-09
Max	115.3E-09	113.2E-09	112.1E-09	116.2E-09	110.6E-09	115.5E-09	114.2E-09	111.2E-09	115.8E-09	110.8E-09	107.8E-09	110.7E-09	115.8E-09
Average	79.4E-09	86.4E-09	76.8E-09	79.9E-09	76.8E-09	81.2E-09	80.1E-09	77.4E-09	80.9E-09	77.4E-09	75.5E-09	77.8E-09	81.2E-09
Sigma	25.4E-09	21.2E-09	25.0E-09	25.7E-09	23.9E-09	24.2E-09	24.1E-09	23.9E-09	24.7E-09	23.6E-09	22.8E-09	23.2E-09	24.5E-09

**Drift Calculation**

IEBO2	0 kRad	8.1 kRad	22.5 kRad	53.1 kRad	108.9 kRad	162.9 kRad	204.3 kRad	255.6 kRad	305.1 kRad	351 kRad	396 kRad	24 Hours	168 Hours
OFF POTON samples													
26	-	24.3E-09	-1.9E-09	490.0E-12	-1.2E-09	3.3E-09	1.5E-09	-914.0E-12	3.7E-09	-364.0E-12	-1.7E-09	352.0E-12	2.7E-09
27	-	-1.4E-09	-2.7E-09	126.0E-12	-1.8E-09	2.0E-09	1.7E-09	-1.1E-09	270.0E-12	-970.0E-12	-2.4E-09	-448.0E-12	2.3E-09
28	-	-2.0E-09	-3.1E-09	960.0E-12	-4.7E-09	200.0E-12	-1.0E-09	-4.1E-09	560.0E-12	-4.5E-09	-7.5E-09	-4.6E-09	580.0E-12
Average	-	7.0E-09	-2.6E-09	525.3E-12	-2.5E-09	1.9E-09	742.7E-12	-2.0E-09	1.5E-09	-1.9E-09	-3.9E-09	-1.6E-09	1.8E-09
Sigma	-	12.2E-09	511.2E-12	341.4E-12	1.5E-09	1.3E-09	1.2E-09	1.4E-09	1.6E-09	1.8E-09	2.6E-09	2.2E-09	910.3E-12

**Measurements**

IEBO2	0 kRad	8.1 kRad	22.5 kRad	53.1 kRad	108.9 kRad	162.9 kRad	204.3 kRad	255.6 kRad	305.1 kRad	351 kRad	396 kRad	24 Hours	168 Hours
21_REF	73.3E-09	70.5E-09	72.1E-09	73.5E-09	71.8E-09	72.7E-09	75.1E-09	71.2E-09	76.1E-09	73.1E-09	70.5E-09	72.1E-09	76.2E-09
OFF TID samples													
33	60.4E-09	58.8E-09	58.6E-09	60.9E-09	58.8E-09	61.0E-09	61.8E-09	60.1E-09	62.4E-09	59.8E-09	57.7E-09	60.4E-09	62.0E-09
34	45.5E-09	45.3E-09	44.6E-09	46.9E-09	45.1E-09	47.9E-09	47.6E-09	46.4E-09	47.7E-09	46.1E-09	44.7E-09	46.5E-09	46.9E-09
36	114.9E-09	113.4E-09	112.9E-09	116.0E-09	112.6E-09	118.7E-09	116.7E-09	114.7E-09	115.1E-09	113.8E-09	111.4E-09	114.4E-09	118.4E-09
Statistics													
Min	45.5E-09	45.3E-09	44.6E-09	46.9E-09	45.1E-09	47.9E-09	47.6E-09	46.4E-09	47.7E-09	46.1E-09	44.7E-09	46.5E-09	46.9E-09
Max	114.9E-09	113.4E-09	112.9E-09	116.0E-09	112.6E-09	118.7E-09	116.7E-09	114.7E-09	115.1E-09	113.8E-09	111.4E-09	114.4E-09	118.4E-09
Average	73.6E-09	72.5E-09	72.0E-09	74.6E-09	72.2E-09	75.8E-09	75.4E-09	73.7E-09	75.1E-09	73.2E-09	71.3E-09	73.7E-09	75.8E-09
Sigma	29.8E-09	29.4E-09	29.5E-09	29.8E-09	29.1E-09	30.7E-09	29.8E-09	29.5E-09	28.9E-09	29.2E-09	28.9E-09	29.3E-09	30.8E-09

**Drift Calculation**

IEBO2	0 kRad	8.1 kRad	22.5 kRad	53.1 kRad	108.9 kRad	162.9 kRad	204.3 kRad	255.6 kRad	305.1 kRad	351 kRad	396 kRad	24 Hours	168 Hours
OFF TID samples													
33	-	-1.6E-09	-1.9E-09	446.0E-12	-1.6E-09	522.0E-12	1.4E-09	-366.0E-12	1.9E-09	-692.0E-12	-2.7E-09	-84.0E-12	1.6E-09
34	-	-232.0E-12	-950.0E-12	1.3E-09	-386.0E-12	2.4E-09	2.0E-09	890.0E-12	2.2E-09	518.0E-12	-874.0E-12	962.0E-12	1.3E-09
36	-	-1.5E-09	-2.0E-09	1.1E-09	-2.3E-09	3.8E-09	1.9E-09	-200.0E-12	280.0E-12	-1.1E-09	-3.5E-09	-500.0E-12	3.5E-09
Average	-	-1.1E-09	-1.6E-09	959.3E-12	-1.4E-09	2.2E-09	1.8E-09	108.0E-12	1.5E-09	-418.0E-12	-2.4E-09	126.0E-12	2.2E-09
Sigma	-	627.8E-12	459.1E-12	375.1E-12	791.0E-12	1.3E-09	286.0E-12	557.1E-12	846.7E-12	680.5E-12	1.1E-09	615.1E-12	985.4E-12

Parameter : Collector-Emitter Breakdown Volatge : V(BR)CEO

Test conditions : IC=100mA

Unit : V

Spec Limit Min : 80.0

Spec limits are represented in bold lines on the graphic.

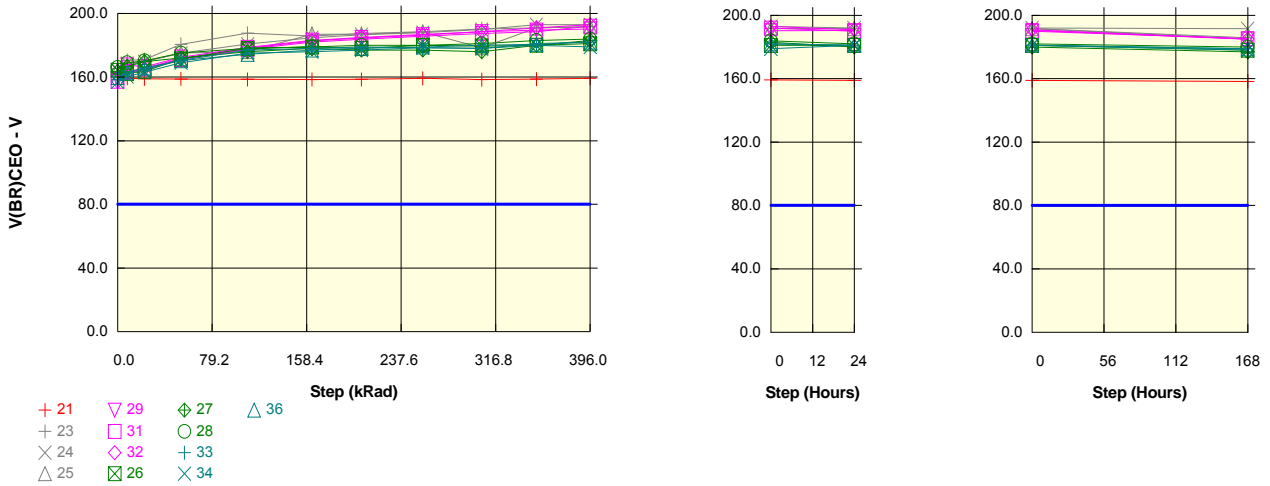

Measurements

V(BR)CEO	0 kRad	8.1 kRad	22.5 kRad	53.1 kRad	108.9 kRad	162.9 kRad	204.3 kRad	255.6 kRad	305.1 kRad	351 kRad	396 kRad	24 Hours	168 Hours
21_REF	158.6	159.3	158.9	158.9	158.6	158.6	158.6	159.2	158.4	158.8	159.3	159.0	158.3
ON PROTON samples													
23	165.6	170.6	171.0	180.6	187.5	185.8	187.4	188.5	190.4	190.9	191.7	191.7	185.9
24	164.6	168.6	169.8	174.9	180.7	184.8	186.7	187.9	189.9	193.0	193.0	192.0	191.5
25	164.7	167.5	169.9	175.3	176.0	187.0	186.9	188.5	178.5	190.9	191.5	191.6	185.1
Statistics													
Min	164.6	167.5	169.8	174.9	176.0	184.8	186.7	187.9	178.5	190.9	191.5	191.6	185.1
Max	165.6	170.6	171.0	180.6	187.5	187.0	187.4	188.5	190.4	193.0	193.0	192.0	191.5
Average	165.0	168.9	170.2	176.9	181.4	185.9	187.0	188.3	186.3	191.6	192.1	191.7	187.5
Sigma	0.4	1.3	0.6	2.6	4.7	0.9	0.3	0.3	5.5	1.0	0.7	0.2	2.9

Drift Calculation

V(BR)CEO	0 kRad	8.1 kRad	22.5 kRad	53.1 kRad	108.9 kRad	162.9 kRad	204.3 kRad	255.6 kRad	305.1 kRad	351 kRad	396 kRad	24 Hours	168 Hours
ON PROTON samples													
23	-	5.0E+00	5.5E+00	15.1E+00	22.0E+00	20.3E+00	21.8E+00	23.0E+00	24.8E+00	25.4E+00	26.1E+00	26.1E+00	20.3E+00
24	-	4.0E+00	5.2E+00	10.3E+00	16.1E+00	20.1E+00	22.1E+00	23.3E+00	25.3E+00	28.4E+00	28.4E+00	27.4E+00	26.9E+00
25	-	2.8E+00	5.2E+00	10.6E+00	11.3E+00	22.3E+00	22.2E+00	23.8E+00	13.8E+00	26.2E+00	26.8E+00	26.9E+00	20.4E+00
Average	-	3.9E+00	5.3E+00	12.0E+00	16.5E+00	20.9E+00	22.0E+00	23.4E+00	21.3E+00	26.7E+00	27.1E+00	26.8E+00	22.5E+00
Sigma	-	910.6E-03	136.0E-03	2.2E+00	4.4E+00	998.0E-03	155.2E-03	319.0E-03	5.3E+00	1.3E+00	946.7E-03	521.8E-03	3.1E+00

Measurements

V(BR)CEO	0 kRad	8.1 kRad	22.5 kRad	53.1 kRad	108.9 kRad	162.9 kRad	204.3 kRad	255.6 kRad	305.1 kRad	351 kRad	396 kRad	24 Hours	168 Hours
21_REF	158.6	159.3	158.9	158.9	158.6	158.6	158.6	159.2	158.4	158.8	159.3	159.0	158.3
ON TID samples													
29	158.5	167.6	166.5	172.5	178.7	183.1	185.0	186.8	188.6	189.6	190.4	190.4	184.9
31	157.4	163.6	165.2	171.1	177.5	182.0	183.8	185.6	187.5	188.5	192.0	190.0	185.3
32	157.5	162.3	165.4	171.7	178.2	182.7	184.6	186.4	188.5	191.0	193.0	191.0	185.0
Statistics													
Min	157.4	162.3	165.2	171.1	177.5	182.0	183.8	185.6	187.5	188.5	190.4	190.0	184.9
Max	158.5	167.6	166.5	172.5	178.7	183.1	185.0	186.8	188.6	191.0	193.0	191.0	185.3
Average	157.8	164.5	165.7	171.8	178.2	182.6	184.4	186.3	188.2	189.7	191.8	190.5	185.1
Sigma	0.5	2.3	0.6	0.6	0.5	0.5	0.5	0.5	0.5	1.0	1.1	0.4	0.2

Drift Calculation

V(BR)CEO	0 kRad	8.1 kRad	22.5 kRad	53.1 kRad	108.9 kRad	162.9 kRad	204.3 kRad	255.6 kRad	305.1 kRad	351 kRad	396 kRad	24 Hours	168 Hours
ON TID samples													
29	-	9.1E+00	8.0E+00	14.0E+00	20.2E+00	24.6E+00	26.4E+00	28.2E+00	30.1E+00	31.1E+00	31.8E+00	31.9E+00	26.4E+00
31	-	6.1E+00	7.8E+00	13.7E+00	20.1E+00	24.6E+00	26.3E+00	28.2E+00	30.1E+00	31.1E+00	34.6E+00	32.6E+00	27.9E+00
32	-	4.8E+00	7.9E+00	14.1E+00	20.7E+00	25.2E+00	27.1E+00	28.9E+00	31.0E+00	33.5E+00	35.5E+00	33.5E+00	27.5E+00
Average	-	6.7E+00	7.9E+00	13.9E+00	20.3E+00	24.8E+00	26.6E+00	28.4E+00	30.4E+00	31.9E+00	34.0E+00	32.6E+00	27.3E+00
Sigma	-	1.8E+00	80.4E-03	195.1E-03	248.5E-03	276.5E-03	317.5E-03	332.4E-03	452.6E-03	1.1E+00	1.6E+00	663.4E-03	612.7E-03

Hirex Engineering	Total Dose Radiation Test Report									Ref.:	HRX/TID/1012		
	2N5154					Microsemi				Issue:	01		

**Measurements**

V(BR)CEO	0 kRad	8.1 kRad	22.5 kRad	53.1 kRad	108.9 kRad	162.9 kRad	204.3 kRad	255.6 kRad	305.1 kRad	351 kRad	396 kRad	24 Hours	168 Hours
21_REF	158.6	159.3	158.9	158.9	158.6	158.6	158.6	159.2	158.4	158.8	159.3	159.0	158.3
OFF POTON samples													
26	164.3	162.4	163.6	171.5	178.0	179.0	178.0	180.0	179.5	180.0	181.0	181.0	178.0
27	163.6	166.8	169.8	172.0	176.0	178.0	177.0	177.0	176.0	180.0	183.0	180.0	177.0
28	166.0	169.0	170.3	175.1	178.0	179.0	180.0	180.0	181.0	183.0	184.0	182.0	180.0
Statistics													
Min	163.6	162.4	163.6	171.5	176.0	178.0	177.0	177.0	176.0	180.0	181.0	180.0	177.0
Max	166.0	169.0	170.3	175.1	178.0	179.0	180.0	180.0	181.0	183.0	184.0	182.0	180.0
Average	164.6	166.1	167.9	172.9	177.3	178.7	178.3	179.0	178.8	181.0	182.7	181.0	178.3
Sigma	1.0	2.7	3.0	1.6	0.9	0.5	1.2	1.4	2.1	1.4	1.2	0.8	1.2

**Drift Calculation**

V(BR)CEO	0 kRad	8.1 kRad	22.5 kRad	53.1 kRad	108.9 kRad	162.9 kRad	204.3 kRad	255.6 kRad	305.1 kRad	351 kRad	396 kRad	24 Hours	168 Hours
OFF POTON samples													
26	-	-1.9E+00	-701.6E-03	7.2E+00	13.7E+00	14.7E+00	13.7E+00	15.7E+00	15.2E+00	15.7E+00	16.7E+00	16.7E+00	13.7E+00
27	-	3.1E+00	6.1E+00	8.4E+00	12.4E+00	14.4E+00	13.4E+00	13.4E+00	12.4E+00	16.4E+00	19.4E+00	16.4E+00	13.4E+00
28	-	3.0E+00	4.3E+00	9.1E+00	12.0E+00	13.0E+00	14.0E+00	14.0E+00	15.0E+00	17.0E+00	18.0E+00	16.0E+00	14.0E+00
Average	-	1.4E+00	3.2E+00	8.2E+00	12.7E+00	14.0E+00	13.7E+00	14.4E+00	14.2E+00	16.4E+00	18.0E+00	16.4E+00	13.7E+00
Sigma	-	2.3E+00	2.9E+00	800.8E-03	731.5E-03	734.5E-03	261.4E-03	987.4E-03	1.3E+00	530.7E-03	1.1E+00	285.8E-03	261.4E-03

**Measurements**

V(BR)CEO	0 kRad	8.1 kRad	22.5 kRad	53.1 kRad	108.9 kRad	162.9 kRad	204.3 kRad	255.6 kRad	305.1 kRad	351 kRad	396 kRad	24 Hours	168 Hours
21_REF	158.6	159.3	158.9	158.9	158.6	158.6	158.6	159.2	158.4	158.8	159.3	159.0	158.3
OFF TID samples													
33	158.5	162.0	164.7	170.5	177.0	178.0	179.0	178.5	178.0	181.0	182.0	181.0	179.0
34	157.0	160.4	163.2	169.0	175.0	176.0	177.0	178.5	178.0	180.0	179.0	181.0	178.0
36	159.6	163.1	165.8	170.3	174.3	177.0	178.1	178.9	180.1	180.6	182.0	181.3	178.8
Statistics													
Min	157.0	160.4	163.2	169.0	174.3	176.0	177.0	178.5	178.0	180.0	179.0	181.0	178.0
Max	159.6	163.1	165.8	170.5	177.0	178.0	179.0	178.9	180.1	181.0	182.0	181.3	179.0
Average	158.4	161.8	164.6	169.9	175.4	177.0	178.0	178.6	178.7	180.5	181.0	181.1	178.6
Sigma	1.1	1.1	1.1	0.7	1.1	0.8	0.8	0.2	1.0	0.4	1.4	0.1	0.4

**Drift Calculation**

V(BR)CEO	0 kRad	8.1 kRad	22.5 kRad	53.1 kRad	108.9 kRad	162.9 kRad	204.3 kRad	255.6 kRad	305.1 kRad	351 kRad	396 kRad	24 Hours	168 Hours
OFF TID samples													
33	-	3.5E+00	6.2E+00	12.0E+00	18.5E+00	19.5E+00	20.5E+00	20.0E+00	19.5E+00	22.5E+00	23.5E+00	22.5E+00	20.5E+00
34	-	3.3E+00	6.1E+00	12.0E+00	18.0E+00	19.0E+00	20.0E+00	21.5E+00	21.0E+00	23.0E+00	22.0E+00	24.0E+00	21.0E+00
36	-	3.5E+00	6.2E+00	10.7E+00	14.7E+00	17.3E+00	18.5E+00	19.3E+00	20.4E+00	21.0E+00	22.4E+00	21.6E+00	19.2E+00
Average	-	3.4E+00	6.2E+00	11.5E+00	17.0E+00	18.6E+00	19.6E+00	20.2E+00	20.3E+00	22.1E+00	22.6E+00	22.7E+00	20.2E+00
Sigma	-	75.9E-03	29.4E-03	589.3E-03	1.7E+00	904.9E-03	827.0E-03	914.2E-03	622.7E-03	827.0E-03	633.0E-03	964.2E-03	736.0E-03

Parameter : Collector-Emitter Saturation Voltage : VCE(SAT)1

Test conditions : IC=2.5A. IB=250mA

Unit : V

Spec Limit Max : 750.0E-03

Spec limits are represented in bold lines on the graphic.

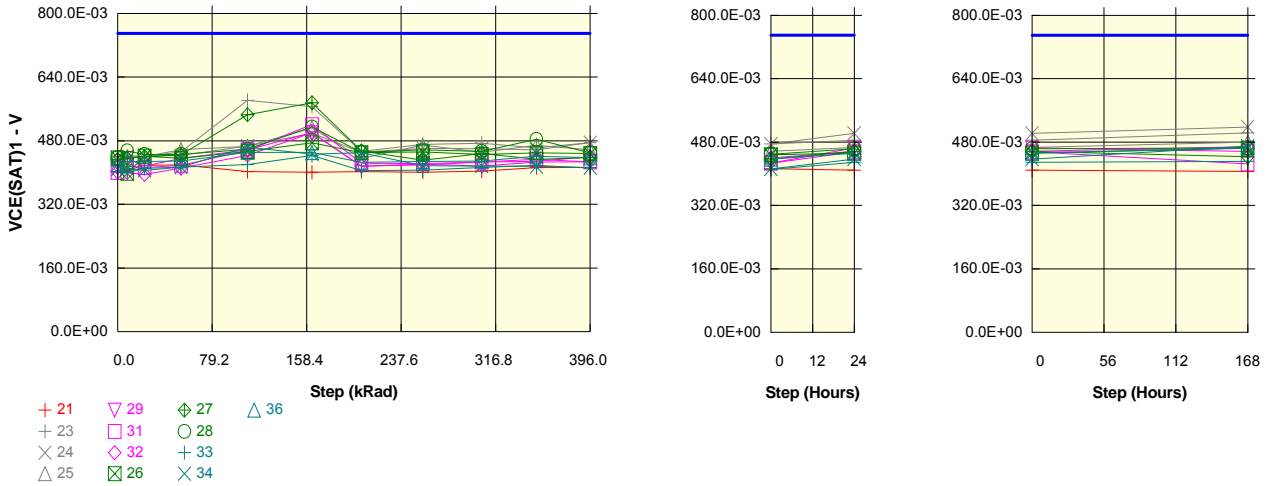

Measurements

VCE(SAT)1	0 kRad	8.1 kRad	22.5 kRad	53.1 kRad	108.9 kRad	162.9 kRad	204.3 kRad	255.6 kRad	305.1 kRad	351 kRad	396 kRad	24 Hours	168 Hours
21 REF	401.2E-03	406.0E-03	418.4E-03	419.2E-03	402.4E-03	400.8E-03	402.5E-03	401.2E-03	403.7E-03	412.8E-03	413.1E-03	409.6E-03	406.4E-03
ON PROTON samples													
23	439.6E-03	442.0E-03	440.4E-03	452.0E-03	581.6E-03	566.0E-03	453.1E-03	470.8E-03	473.8E-03	462.0E-03	475.2E-03	485.2E-03	503.6E-03
24	430.0E-03	441.6E-03	440.8E-03	443.6E-03	466.4E-03	498.8E-03	451.3E-03	461.2E-03	460.0E-03	457.2E-03	475.2E-03	502.0E-03	518.4E-03
25	435.6E-03	438.0E-03	439.6E-03	458.0E-03	466.0E-03	512.4E-03	435.6E-03	468.8E-03	451.1E-03	468.8E-03	456.8E-03	466.4E-03	480.0E-03
Statistics													
Min	430.0E-03	438.0E-03	439.6E-03	443.6E-03	466.0E-03	498.8E-03	435.6E-03	461.2E-03	451.1E-03	457.2E-03	456.8E-03	466.4E-03	480.0E-03
Max	439.6E-03	442.0E-03	440.8E-03	458.0E-03	581.6E-03	566.0E-03	453.1E-03	470.8E-03	473.8E-03	468.8E-03	475.2E-03	502.0E-03	518.4E-03
Average	435.1E-03	440.5E-03	440.3E-03	451.2E-03	504.7E-03	525.7E-03	446.7E-03	466.9E-03	461.6E-03	462.7E-03	469.1E-03	484.5E-03	500.7E-03
Sigma	3.9E-03	1.8E-03	498.9E-06	5.9E-03	54.4E-03	29.0E-03	7.9E-03	4.2E-03	9.3E-03	4.8E-03	8.7E-03	14.5E-03	15.8E-03

Drift Calculation

VCE(SAT)1	0 kRad	8.1 kRad	22.5 kRad	53.1 kRad	108.9 kRad	162.9 kRad	204.3 kRad	255.6 kRad	305.1 kRad	351 kRad	396 kRad	24 Hours	168 Hours
ON PROTON samples													
23	-	2.4E-03	800.0E-06	12.4E-03	142.0E-03	126.4E-03	13.5E-03	31.2E-03	34.2E-03	22.4E-03	35.6E-03	45.6E-03	64.0E-03
24	-	11.6E-03	10.8E-03	13.6E-03	36.4E-03	68.8E-03	21.3E-03	31.2E-03	30.0E-03	27.2E-03	45.2E-03	72.0E-03	88.4E-03
25	-	2.4E-03	4.0E-03	22.4E-03	30.4E-03	76.8E-03	-6.0E-09	33.2E-03	15.5E-03	33.2E-03	21.2E-03	30.8E-03	44.4E-03
Average	-	5.5E-03	5.2E-03	16.1E-03	69.6E-03	90.7E-03	11.6E-03	31.9E-03	26.6E-03	27.6E-03	34.0E-03	49.5E-03	65.6E-03
Sigma	-	4.3E-03	4.2E-03	4.6E-03	51.3E-03	25.5E-03	8.8E-03	971.2E-06	8.0E-03	4.4E-03	9.9E-03	17.0E-03	18.0E-03

Measurements

VCE(SAT)1	0 kRad	8.1 kRad	22.5 kRad	53.1 kRad	108.9 kRad	162.9 kRad	204.3 kRad	255.6 kRad	305.1 kRad	351 kRad	396 kRad	24 Hours	168 Hours
21 REF	401.2E-03	406.0E-03	418.4E-03	419.2E-03	402.4E-03	400.8E-03	402.5E-03	401.2E-03	403.7E-03	412.8E-03	413.1E-03	409.6E-03	406.4E-03
ON TID samples													
29	410.8E-03	436.0E-03	416.4E-03	435.2E-03	456.8E-03	500.0E-03	415.6E-03	421.2E-03	416.1E-03	426.4E-03	427.2E-03	465.2E-03	456.4E-03
31	400.4E-03	417.2E-03	412.4E-03	418.4E-03	456.0E-03	520.4E-03	423.2E-03	422.8E-03	426.8E-03	433.2E-03	426.8E-03	455.6E-03	425.2E-03
32	401.6E-03	400.0E-03	395.6E-03	411.2E-03	443.2E-03	500.0E-03	416.3E-03	419.5E-03	426.6E-03	428.4E-03	440.0E-03	457.2E-03	468.8E-03
Statistics													
Min	400.4E-03	400.0E-03	395.6E-03	411.2E-03	443.2E-03	500.0E-03	415.6E-03	419.5E-03	416.1E-03	426.4E-03	426.8E-03	455.6E-03	425.2E-03
Max	410.8E-03	436.0E-03	416.4E-03	435.2E-03	456.8E-03	520.4E-03	423.2E-03	422.8E-03	426.8E-03	433.2E-03	440.0E-03	465.2E-03	468.8E-03
Average	404.3E-03	417.7E-03	408.1E-03	421.6E-03	452.0E-03	506.8E-03	418.4E-03	421.2E-03	423.2E-03	429.3E-03	431.3E-03	459.3E-03	450.1E-03
Sigma	4.6E-03	14.7E-03	9.0E-03	10.1E-03	6.2E-03	9.6E-03	3.4E-03	1.3E-03	5.0E-03	2.9E-03	6.1E-03	4.2E-03	18.3E-03

Drift Calculation

VCE(SAT)1	0 kRad	8.1 kRad	22.5 kRad	53.1 kRad	108.9 kRad	162.9 kRad	204.3 kRad	255.6 kRad	305.1 kRad	351 kRad	396 kRad	24 Hours	168 Hours
ON TID samples													
29	-	25.2E-03	5.6E-03	24.4E-03	46.0E-03	89.2E-03	4.8E-03	10.4E-03	5.3E-03	15.6E-03	16.4E-03	54.4E-03	45.6E-03
31	-	16.8E-03	12.0E-03	18.0E-03	55.6E-03	120.0E-03	22.8E-03	22.4E-03	26.4E-03	32.8E-03	26.4E-03	55.2E-03	24.8E-03
32	-	-1.6E-03	-6.0E-03	9.6E-03	41.6E-03	98.4E-03	14.7E-03	17.9E-03	25.0E-03	26.8E-03	38.4E-03	55.6E-03	67.2E-03
Average	-	13.5E-03	3.9E-03	17.3E-03	47.7E-03	102.5E-03	14.1E-03	16.9E-03	18.9E-03	25.1E-03	27.1E-03	55.1E-03	45.9E-03
Sigma	-	11.2E-03	7.4E-03	6.1E-03	5.8E-03	12.9E-03	7.4E-03	5.0E-03	9.7E-03	7.1E-03	9.0E-03	498.9E-06	17.3E-03

Hirex Engineering	Total Dose Radiation Test Report									Ref.:	HRX/TID/1012		
	2N5154					Microsemi				Issue:	01		

**Measurements**

VCE(SAT)1	0 kRad	8.1 kRad	22.5 kRad	53.1 kRad	108.9 kRad	162.9 kRad	204.3 kRad	255.6 kRad	305.1 kRad	351 kRad	396 kRad	24 Hours	168 Hours
21_REF	401.2E-03	406.0E-03	418.4E-03	419.2E-03	402.4E-03	400.8E-03	402.5E-03	401.2E-03	403.7E-03	412.8E-03	413.1E-03	409.6E-03	406.4E-03
OFF POTON samples													
26	436.8E-03	398.4E-03	441.2E-03	436.0E-03	453.2E-03	474.8E-03	450.0E-03	452.2E-03	445.6E-03	449.2E-03	448.0E-03	452.4E-03	465.2E-03
27	432.8E-03	435.6E-03	440.4E-03	444.8E-03	545.6E-03	575.6E-03	454.8E-03	430.8E-03	448.4E-03	433.6E-03	437.6E-03	456.4E-03	442.8E-03
28	437.6E-03	454.6E-03	445.6E-03	445.6E-03	458.8E-03	514.8E-03	450.8E-03	457.0E-03	453.4E-03	483.6E-03	449.2E-03	463.6E-03	465.2E-03
Statistics													
Min	432.8E-03	398.4E-03	440.4E-03	436.0E-03	453.2E-03	474.8E-03	450.0E-03	430.8E-03	445.6E-03	433.6E-03	437.6E-03	452.4E-03	442.8E-03
Max	437.6E-03	454.6E-03	445.6E-03	445.6E-03	545.6E-03	575.6E-03	454.8E-03	457.0E-03	453.4E-03	483.6E-03	449.2E-03	463.6E-03	465.2E-03
Average	435.7E-03	429.5E-03	442.4E-03	442.1E-03	485.9E-03	521.7E-03	451.9E-03	446.7E-03	449.1E-03	455.5E-03	444.9E-03	457.5E-03	457.7E-03
Sigma	2.1E-03	23.3E-03	2.3E-03	4.3E-03	42.3E-03	41.4E-03	2.1E-03	11.4E-03	3.2E-03	20.9E-03	5.2E-03	4.6E-03	10.6E-03

**Drift Calculation**

VCE(SAT)1	0 kRad	8.1 kRad	22.5 kRad	53.1 kRad	108.9 kRad	162.9 kRad	204.3 kRad	255.6 kRad	305.1 kRad	351 kRad	396 kRad	24 Hours	168 Hours
OFF POTON samples													
26	-	-38.4E-03	4.4E-03	-800.0E-06	16.4E-03	38.0E-03	13.2E-03	15.4E-03	8.8E-03	12.4E-03	11.2E-03	15.6E-03	28.4E-03
27	-	2.8E-03	7.6E-03	12.0E-03	112.8E-03	142.8E-03	22.0E-03	-2.0E-03	15.6E-03	800.0E-06	4.8E-03	23.6E-03	10.0E-03
28	-	17.0E-03	8.0E-03	8.0E-03	21.2E-03	77.2E-03	13.2E-03	19.4E-03	15.8E-03	46.0E-03	11.6E-03	26.0E-03	27.6E-03
Average	-	-6.2E-03	6.7E-03	6.4E-03	50.1E-03	86.0E-03	16.1E-03	10.9E-03	13.4E-03	19.7E-03	9.2E-03	21.7E-03	22.0E-03
Sigma	-	23.5E-03	1.6E-03	5.3E-03	44.4E-03	43.2E-03	4.1E-03	9.3E-03	3.2E-03	19.2E-03	3.1E-03	4.4E-03	8.5E-03

**Measurements**

VCE(SAT)1	0 kRad	8.1 kRad	22.5 kRad	53.1 kRad	108.9 kRad	162.9 kRad	204.3 kRad	255.6 kRad	305.1 kRad	351 kRad	396 kRad	24 Hours	168 Hours
21_REF	401.2E-03	406.0E-03	418.4E-03	419.2E-03	402.4E-03	400.8E-03	402.5E-03	401.2E-03	403.7E-03	412.8E-03	413.1E-03	409.6E-03	406.4E-03
OFF TID samples													
33	403.2E-03	400.0E-03	410.4E-03	413.6E-03	420.0E-03	442.8E-03	405.1E-03	406.0E-03	413.2E-03	418.4E-03	411.2E-03	428.8E-03	431.6E-03
34	408.4E-03	410.0E-03	405.6E-03	413.6E-03	464.0E-03	446.4E-03	450.0E-03	417.4E-03	416.6E-03	415.6E-03	412.8E-03	437.6E-03	469.6E-03
36	420.0E-03	428.0E-03	428.0E-03	429.2E-03	450.8E-03	450.4E-03	426.2E-03	427.8E-03	429.0E-03	441.2E-03	437.2E-03	452.0E-03	464.8E-03
Statistics													
Min	403.2E-03	400.0E-03	405.6E-03	413.6E-03	420.0E-03	442.8E-03	405.1E-03	406.0E-03	413.2E-03	415.6E-03	411.2E-03	428.8E-03	431.6E-03
Max	420.0E-03	428.0E-03	428.0E-03	429.2E-03	464.0E-03	450.4E-03	450.0E-03	427.8E-03	429.0E-03	441.2E-03	437.2E-03	452.0E-03	469.6E-03
Average	410.5E-03	412.7E-03	414.7E-03	418.8E-03	444.9E-03	446.5E-03	427.1E-03	417.0E-03	419.6E-03	425.1E-03	420.4E-03	439.5E-03	455.3E-03
Sigma	7.0E-03	11.6E-03	9.6E-03	7.4E-03	18.4E-03	3.1E-03	18.4E-03	8.9E-03	6.8E-03	11.5E-03	11.9E-03	9.6E-03	16.9E-03

**Drift Calculation**

VCE(SAT)1	0 kRad	8.1 kRad	22.5 kRad	53.1 kRad	108.9 kRad	162.9 kRad	204.3 kRad	255.6 kRad	305.1 kRad	351 kRad	396 kRad	24 Hours	168 Hours
OFF TID samples													
33	-	-3.2E-03	7.2E-03	10.4E-03	16.8E-03	39.6E-03	1.9E-03	2.8E-03	10.0E-03	15.2E-03	8.0E-03	25.6E-03	28.4E-03
34	-	1.6E-03	-2.8E-03	5.2E-03	55.6E-03	38.0E-03	41.6E-03	9.0E-03	8.2E-03	7.2E-03	4.4E-03	29.2E-03	61.2E-03
36	-	8.0E-03	8.0E-03	9.2E-03	30.8E-03	30.4E-03	6.2E-03	7.8E-03	9.0E-03	21.2E-03	17.2E-03	32.0E-03	44.8E-03
Average	-	2.1E-03	4.1E-03	8.3E-03	34.4E-03	36.0E-03	16.6E-03	6.5E-03	9.1E-03	14.5E-03	9.9E-03	28.9E-03	44.8E-03
Sigma	-	4.6E-03	4.9E-03	2.2E-03	16.0E-03	4.0E-03	17.8E-03	2.7E-03	735.4E-06	5.7E-03	5.4E-03	2.6E-03	13.4E-03



Parameter : Collector-Emitter Saturation Voltage : VCE(SAT)2

Test conditions : IC=5A. IB=500mA

Unit : V

Spec Limit Max : 1.5E+00

Spec limits are represented in bold lines on the graphic.

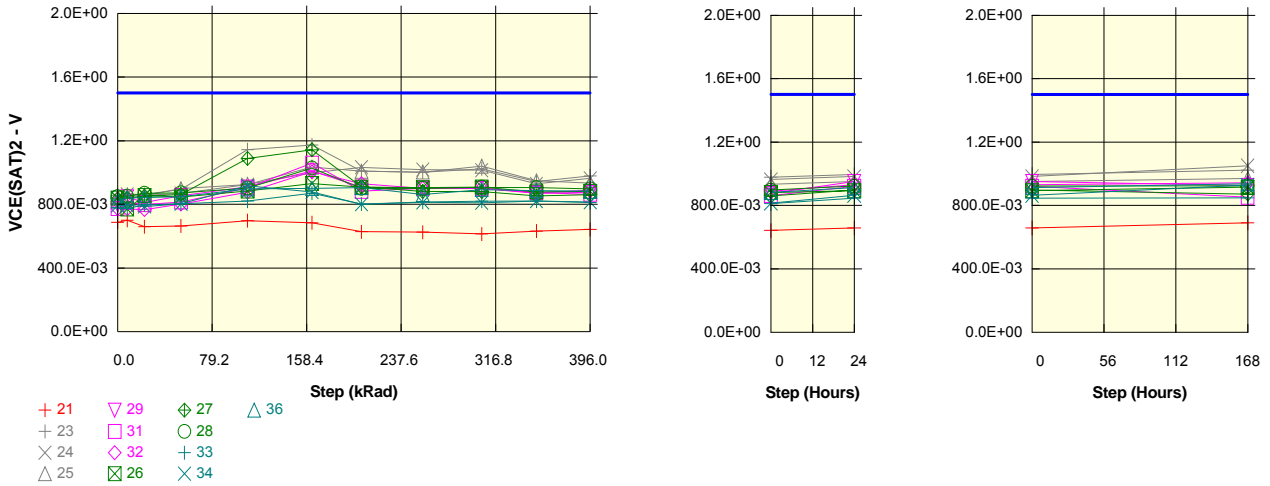

Measurements

VCE(SAT)2	0 kRad	8.1 kRad	22.5 kRad	53.1 kRad	108.9 kRad	162.9 kRad	204.3 kRad	255.6 kRad	305.1 kRad	351 kRad	396 kRad	24 Hours	168 Hours
21 REF	688.0E-03	700.0E-03	660.4E-03	664.0E-03	697.6E-03	684.8E-03	628.8E-03	625.2E-03	614.0E-03	632.4E-03	642.4E-03	658.8E-03	691.2E-03
ON PROTON samples													
23	856.4E-03	864.8E-03	862.4E-03	894.0E-03	1.1E+00	1.2E+00	1.0E+00	1.0E+00	1.0E+00	944.4E-03	978.8E-03	995.6E-03	1.0E+00
24	834.8E-03	864.0E-03	856.8E-03	868.8E-03	924.4E-03	1.0E+00	1.0E+00	1.0E+00	1.0E+00	929.2E-03	964.0E-03	983.2E-03	1.1E+00
25	847.6E-03	850.8E-03	855.2E-03	898.8E-03	925.2E-03	1.0E+00	1.0E+00	1.0E+00	1.0E+00	948.0E-03	934.4E-03	951.2E-03	971.2E-03
Statistics													
Min	834.8E-03	850.8E-03	855.2E-03	868.8E-03	924.4E-03	1.0E+00	1.0E+00	1.0E+00	1.0E+00	929.2E-03	934.4E-03	951.2E-03	971.2E-03
Max	856.4E-03	864.8E-03	862.4E-03	898.8E-03	1.1E+00	1.2E+00	1.0E+00	1.0E+00	1.0E+00	948.0E-03	978.8E-03	995.6E-03	1.1E+00
Average	846.3E-03	859.9E-03	858.1E-03	887.2E-03	997.7E-03	1.1E+00	1.0E+00	1.0E+00	1.0E+00	940.5E-03	959.1E-03	976.7E-03	1.0E+00
Sigma	8.9E-03	6.4E-03	3.1E-03	13.2E-03	103.1E-03	74.9E-03	11.8E-03	7.4E-03	10.7E-03	8.1E-03	18.5E-03	18.7E-03	32.9E-03

Drift Calculation

VCE(SAT)2	0 kRad	8.1 kRad	22.5 kRad	53.1 kRad	108.9 kRad	162.9 kRad	204.3 kRad	255.6 kRad	305.1 kRad	351 kRad	396 kRad	24 Hours	168 Hours
ON PROTON samples													
23	-	8.4E-03	6.0E-03	37.6E-03	287.2E-03	316.8E-03	151.8E-03	146.8E-03	167.6E-03	88.0E-03	122.4E-03	139.2E-03	167.2E-03
24	-	29.2E-03	22.0E-03	34.0E-03	89.6E-03	165.2E-03	198.8E-03	184.0E-03	180.2E-03	94.4E-03	129.2E-03	148.4E-03	215.6E-03
25	-	3.2E-03	7.6E-03	51.2E-03	77.6E-03	186.8E-03	161.4E-03	155.7E-03	193.2E-03	100.4E-03	86.8E-03	103.6E-03	123.6E-03
Average	-	13.6E-03	11.9E-03	40.9E-03	151.5E-03	222.9E-03	170.7E-03	162.2E-03	180.3E-03	94.3E-03	112.8E-03	130.4E-03	168.8E-03
Sigma	-	11.2E-03	7.2E-03	7.4E-03	96.1E-03	67.0E-03	20.3E-03	15.9E-03	10.5E-03	5.1E-03	18.6E-03	19.3E-03	37.6E-03

Measurements

VCE(SAT)2	0 kRad	8.1 kRad	22.5 kRad	53.1 kRad	108.9 kRad	162.9 kRad	204.3 kRad	255.6 kRad	305.1 kRad	351 kRad	396 kRad	24 Hours	168 Hours
21 REF	688.0E-03	700.0E-03	660.4E-03	664.0E-03	697.6E-03	684.8E-03	628.8E-03	625.2E-03	614.0E-03	632.4E-03	642.4E-03	658.8E-03	691.2E-03
ON TID samples													
29	796.8E-03	846.8E-03	812.4E-03	855.2E-03	909.6E-03	1.0E+00	909.0E-03	901.6E-03	900.2E-03	868.4E-03	876.8E-03	952.0E-03	926.8E-03
31	774.4E-03	812.8E-03	798.4E-03	815.6E-03	903.6E-03	1.1E+00	883.2E-03	901.0E-03	900.9E-03	874.8E-03	862.8E-03	921.6E-03	852.8E-03
32	774.0E-03	772.4E-03	767.6E-03	802.8E-03	877.2E-03	1.0E+00	929.6E-03	901.0E-03	902.4E-03	872.0E-03	890.0E-03	930.8E-03	944.4E-03
Statistics													
Min	774.0E-03	772.4E-03	767.6E-03	802.8E-03	877.2E-03	1.0E+00	883.2E-03	901.0E-03	900.2E-03	868.4E-03	862.8E-03	921.6E-03	852.8E-03
Max	796.8E-03	846.8E-03	812.4E-03	855.2E-03	909.6E-03	1.1E+00	929.6E-03	901.6E-03	902.4E-03	874.8E-03	890.0E-03	952.0E-03	944.4E-03
Average	781.7E-03	810.7E-03	792.8E-03	824.5E-03	896.8E-03	1.0E+00	907.3E-03	901.2E-03	901.2E-03	871.7E-03	876.5E-03	934.8E-03	908.0E-03
Sigma	10.7E-03	30.4E-03	18.7E-03	22.3E-03	14.1E-03	24.4E-03	19.0E-03	310.7E-06	921.4E-06	2.6E-03	11.1E-03	12.7E-03	39.7E-03

Drift Calculation

VCE(SAT)2	0 kRad	8.1 kRad	22.5 kRad	53.1 kRad	108.9 kRad	162.9 kRad	204.3 kRad	255.6 kRad	305.1 kRad	351 kRad	396 kRad	24 Hours	168 Hours
ON TID samples													
29	-	50.0E-03	15.6E-03	58.4E-03	112.8E-03	214.0E-03	112.2E-03	104.8E-03	103.4E-03	71.6E-03	80.0E-03	155.2E-03	130.0E-03
31	-	38.4E-03	24.0E-03	41.2E-03	129.2E-03	285.2E-03	108.8E-03	126.6E-03	126.5E-03	100.4E-03	88.4E-03	147.2E-03	78.4E-03
32	-	-1.6E-03	-6.4E-03	28.8E-03	103.2E-03	231.2E-03	155.6E-03	127.0E-03	128.4E-03	98.0E-03	116.0E-03	156.8E-03	170.4E-03
Average	-	28.9E-03	11.1E-03	42.8E-03	115.1E-03	243.5E-03	125.5E-03	119.5E-03	119.5E-03	90.0E-03	94.8E-03	153.1E-03	126.3E-03
Sigma	-	22.1E-03	12.8E-03	12.1E-03	10.7E-03	30.3E-03	21.3E-03	10.3E-03	11.4E-03	13.0E-03	15.4E-03	4.2E-03	37.7E-03

Hirex Engineering	Total Dose Radiation Test Report								Ref.:	HRX/TID/1012			
	2N5154				Microsemi				Issue:	01			

**Measurements**

VCE(SAT)2	0 kRad	8.1 kRad	22.5 kRad	53.1 kRad	108.9 kRad	162.9 kRad	204.3 kRad	255.6 kRad	305.1 kRad	351 kRad	396 kRad	24 Hours	168 Hours
21_REF	688.0E-03	700.0E-03	660.4E-03	664.0E-03	697.6E-03	684.8E-03	628.8E-03	625.2E-03	614.0E-03	632.4E-03	642.4E-03	658.8E-03	691.2E-03
OFF POTON samples													
26	840.0E-03	770.8E-03	855.6E-03	846.0E-03	884.4E-03	931.2E-03	908.6E-03	904.9E-03	909.4E-03	878.8E-03	882.0E-03	894.0E-03	916.4E-03
27	833.6E-03	840.0E-03	852.0E-03	862.4E-03	1.1E+00	1.1E+00	909.8E-03	881.4E-03	880.4E-03	852.8E-03	860.8E-03	898.0E-03	872.8E-03
28	849.2E-03	852.0E-03	869.6E-03	872.8E-03	903.2E-03	1.0E+00	901.4E-03	901.5E-03	907.8E-03	905.8E-03	897.2E-03	922.8E-03	924.0E-03
Statistics													
Min	833.6E-03	770.8E-03	852.0E-03	846.0E-03	884.4E-03	931.2E-03	901.4E-03	881.4E-03	880.4E-03	852.8E-03	860.8E-03	894.0E-03	872.8E-03
Max	849.2E-03	852.0E-03	869.6E-03	872.8E-03	1.1E+00	1.1E+00	909.8E-03	904.9E-03	909.4E-03	905.8E-03	897.2E-03	922.8E-03	924.0E-03
Average	840.9E-03	820.9E-03	859.1E-03	860.4E-03	958.9E-03	1.0E+00	906.6E-03	895.9E-03	899.2E-03	879.1E-03	880.0E-03	904.9E-03	904.4E-03
Sigma	6.4E-03	35.8E-03	7.6E-03	11.0E-03	92.4E-03	86.6E-03	3.7E-03	10.4E-03	13.3E-03	21.7E-03	14.9E-03	12.7E-03	22.6E-03

**Drift Calculation**

VCE(SAT)2	0 kRad	8.1 kRad	22.5 kRad	53.1 kRad	108.9 kRad	162.9 kRad	204.3 kRad	255.6 kRad	305.1 kRad	351 kRad	396 kRad	24 Hours	168 Hours
OFF POTON samples													
26	-	-69.2E-03	15.6E-03	6.0E-03	44.4E-03	91.2E-03	68.6E-03	64.9E-03	69.4E-03	38.8E-03	42.0E-03	54.0E-03	76.4E-03
27	-	6.4E-03	18.4E-03	28.8E-03	255.6E-03	309.6E-03	76.2E-03	47.8E-03	46.8E-03	19.2E-03	27.2E-03	64.4E-03	39.2E-03
28	-	2.8E-03	20.4E-03	23.6E-03	54.0E-03	179.6E-03	52.2E-03	52.3E-03	58.6E-03	56.6E-03	48.0E-03	73.6E-03	74.8E-03
Average	-	-20.0E-03	18.1E-03	19.5E-03	118.0E-03	193.5E-03	65.7E-03	55.0E-03	58.2E-03	38.2E-03	39.1E-03	64.0E-03	63.5E-03
Sigma	-	34.8E-03	2.0E-03	9.8E-03	97.4E-03	89.7E-03	10.0E-03	7.2E-03	9.2E-03	15.3E-03	8.7E-03	8.0E-03	17.2E-03

**Measurements**

VCE(SAT)2	0 kRad	8.1 kRad	22.5 kRad	53.1 kRad	108.9 kRad	162.9 kRad	204.3 kRad	255.6 kRad	305.1 kRad	351 kRad	396 kRad	24 Hours	168 Hours
21_REF	688.0E-03	700.0E-03	660.4E-03	664.0E-03	697.6E-03	684.8E-03	628.8E-03	625.2E-03	614.0E-03	632.4E-03	642.4E-03	658.8E-03	691.2E-03
OFF TID samples													
33	777.2E-03	775.2E-03	796.0E-03	804.4E-03	821.2E-03	870.8E-03	802.6E-03	814.2E-03	819.8E-03	821.2E-03	811.2E-03	846.4E-03	848.4E-03
34	793.2E-03	793.6E-03	786.4E-03	804.4E-03	916.0E-03	878.0E-03	801.4E-03	813.0E-03	810.5E-03	821.2E-03	814.8E-03	863.6E-03	928.8E-03
36	823.6E-03	840.4E-03	842.8E-03	847.6E-03	897.2E-03	900.4E-03	905.6E-03	862.4E-03	893.2E-03	886.4E-03	883.2E-03	913.2E-03	936.8E-03
Statistics													
Min	777.2E-03	775.2E-03	786.4E-03	804.4E-03	821.2E-03	870.8E-03	801.4E-03	813.0E-03	810.5E-03	821.2E-03	811.2E-03	846.4E-03	848.4E-03
Max	823.6E-03	840.4E-03	842.8E-03	847.6E-03	916.0E-03	900.4E-03	905.6E-03	862.4E-03	893.2E-03	886.4E-03	883.2E-03	913.2E-03	936.8E-03
Average	798.0E-03	803.1E-03	808.4E-03	818.8E-03	878.1E-03	883.1E-03	836.5E-03	829.9E-03	841.2E-03	842.9E-03	836.4E-03	874.4E-03	904.7E-03
Sigma	19.2E-03	27.4E-03	24.6E-03	20.4E-03	41.0E-03	12.6E-03	48.8E-03	23.0E-03	37.0E-03	30.7E-03	33.1E-03	28.3E-03	39.9E-03

**Drift Calculation**

VCE(SAT)2	0 kRad	8.1 kRad	22.5 kRad	53.1 kRad	108.9 kRad	162.9 kRad	204.3 kRad	255.6 kRad	305.1 kRad	351 kRad	396 kRad	24 Hours	168 Hours
OFF TID samples													
33	-	-2.0E-03	18.8E-03	27.2E-03	44.0E-03	93.6E-03	25.4E-03	37.0E-03	42.6E-03	44.0E-03	34.0E-03	69.2E-03	71.2E-03
34	-	400.0E-06	-6.8E-03	11.2E-03	122.8E-03	84.8E-03	8.2E-03	19.8E-03	17.3E-03	28.0E-03	21.6E-03	70.4E-03	135.6E-03
36	-	16.8E-03	19.2E-03	24.0E-03	73.6E-03	76.8E-03	82.0E-03	38.8E-03	69.6E-03	62.8E-03	59.6E-03	89.6E-03	113.2E-03
Average	-	5.1E-03	10.4E-03	20.8E-03	80.1E-03	85.1E-03	38.5E-03	31.9E-03	43.2E-03	44.9E-03	38.4E-03	76.4E-03	106.7E-03
Sigma	-	8.4E-03	12.2E-03	6.9E-03	32.5E-03	6.9E-03	31.5E-03	8.5E-03	21.4E-03	14.2E-03	15.8E-03	9.3E-03	26.7E-03

Parameter : Base-Emitter Saturation Voltage : VBE(SAT)1

Test conditions : IC=2.5A. IB=250mA

Unit : V

Spec Limit Max : 1.450

Spec limits are represented in bold lines on the graphic.

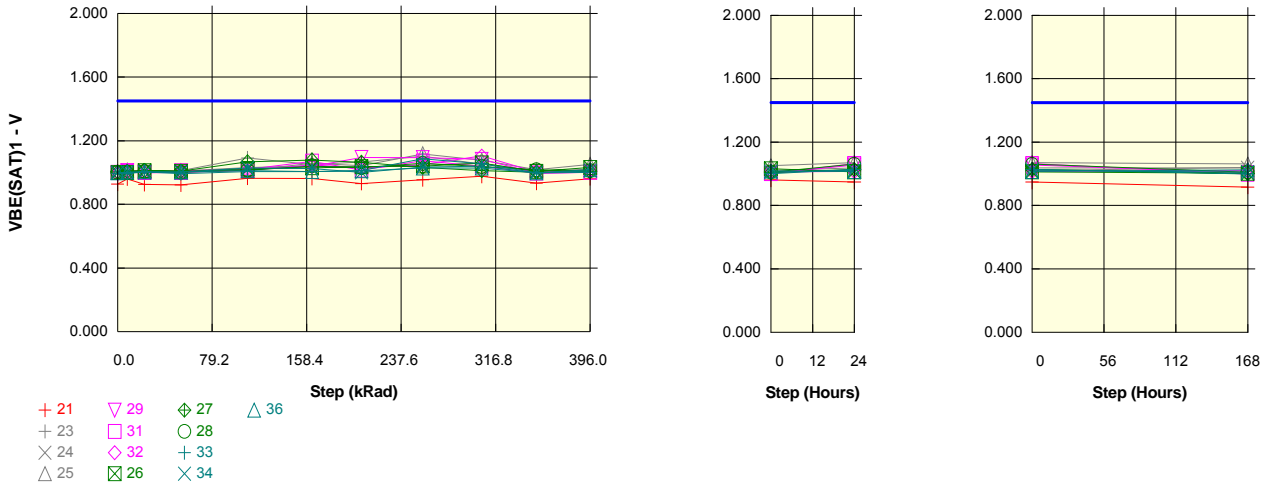

Measurements

VBE(SAT)1	0 kRad	8.1 kRad	22.5 kRad	53.1 kRad	108.9 kRad	162.9 kRad	204.3 kRad	255.6 kRad	305.1 kRad	351 kRad	396 kRad	24 Hours	168 Hours
21_REF	0.928	0.960	0.926	0.922	0.965	0.964	0.932	0.956	0.977	0.934	0.962	0.948	0.917
ON PROTON samples													
23	1.003	1.017	1.006	1.012	1.092	1.050	1.066	1.102	1.054	1.008	1.017	1.020	1.042
24	1.002	1.014	1.006	1.010	1.032	1.043	1.032	1.047	1.058	1.006	1.022	1.038	1.037
25	1.004	1.014	1.009	1.012	1.014	1.059	1.044	1.118	1.078	1.018	1.051	1.072	1.063
Statistics													
Min	1.002	1.014	1.006	1.010	1.014	1.043	1.032	1.047	1.054	1.006	1.017	1.020	1.037
Max	1.004	1.017	1.009	1.012	1.092	1.059	1.066	1.118	1.078	1.018	1.051	1.072	1.063
Average	1.003	1.015	1.007	1.011	1.046	1.051	1.047	1.089	1.063	1.011	1.030	1.043	1.047
Sigma	0.001	0.002	0.001	0.001	0.034	0.006	0.014	0.030	0.010	0.005	0.015	0.022	0.011

Drift Calculation

VBE(SAT)1	0 kRad	8.1 kRad	22.5 kRad	53.1 kRad	108.9 kRad	162.9 kRad	204.3 kRad	255.6 kRad	305.1 kRad	351 kRad	396 kRad	24 Hours	168 Hours
ON PROTON samples													
23	-	14.0E-03	3.2E-03	8.8E-03	89.2E-03	46.8E-03	62.8E-03	99.2E-03	50.8E-03	5.2E-03	14.0E-03	16.4E-03	38.4E-03
24	-	11.6E-03	4.0E-03	8.0E-03	29.2E-03	40.8E-03	29.2E-03	44.8E-03	55.6E-03	3.6E-03	19.2E-03	35.6E-03	34.8E-03
25	-	10.0E-03	4.8E-03	7.6E-03	9.6E-03	54.8E-03	40.4E-03	113.6E-03	74.0E-03	14.0E-03	47.2E-03	67.6E-03	58.8E-03
Average	-	11.9E-03	4.0E-03	8.1E-03	42.7E-03	47.5E-03	44.1E-03	85.9E-03	60.1E-03	7.6E-03	26.8E-03	39.9E-03	44.0E-03
Sigma	-	1.6E-03	653.3E-06	498.8E-06	33.9E-03	5.7E-03	14.0E-03	29.6E-03	10.0E-03	4.6E-03	14.6E-03	21.1E-03	10.6E-03

Measurements

VBE(SAT)1	0 kRad	8.1 kRad	22.5 kRad	53.1 kRad	108.9 kRad	162.9 kRad	204.3 kRad	255.6 kRad	305.1 kRad	351 kRad	396 kRad	24 Hours	168 Hours
21_REF	0.928	0.960	0.926	0.922	0.965	0.964	0.932	0.956	0.977	0.934	0.962	0.948	0.917
ON TID samples													
29	0.994	1.013	1.002	1.011	1.021	1.040	1.095	1.094	1.084	0.996	1.003	1.056	1.009
31	1.001	1.006	1.000	1.001	1.020	1.071	1.016	1.074	1.040	0.997	1.001	1.065	0.997
32	0.995	1.001	0.999	1.001	1.013	1.048	1.028	1.051	1.104	1.002	1.013	1.015	1.021
Statistics													
Min	0.994	1.001	0.999	1.001	1.013	1.040	1.016	1.051	1.040	0.996	1.001	1.015	0.997
Max	1.001	1.013	1.002	1.011	1.021	1.071	1.095	1.094	1.104	1.002	1.013	1.065	1.021
Average	0.997	1.007	1.000	1.004	1.018	1.053	1.046	1.073	1.076	0.998	1.006	1.045	1.009
Sigma	0.003	0.005	0.001	0.005	0.003	0.013	0.035	0.018	0.027	0.003	0.005	0.022	0.010

Drift Calculation

VBE(SAT)1	0 kRad	8.1 kRad	22.5 kRad	53.1 kRad	108.9 kRad	162.9 kRad	204.3 kRad	255.6 kRad	305.1 kRad	351 kRad	396 kRad	24 Hours	168 Hours
ON TID samples													
29	-	19.6E-03	8.4E-03	17.2E-03	27.2E-03	46.0E-03	101.6E-03	100.4E-03	90.0E-03	2.0E-03	9.6E-03	62.0E-03	15.2E-03
31	-	4.8E-03	-1.2E-03	-399.9E-06	18.8E-03	70.0E-03	14.8E-03	72.4E-03	38.8E-03	-4.4E-03	0.0E+00	64.0E-03	-4.0E-03
32	-	6.0E-03	4.0E-03	5.6E-03	18.0E-03	53.2E-03	32.4E-03	55.6E-03	108.8E-03	7.2E-03	17.6E-03	20.0E-03	25.6E-03
Average	-	10.1E-03	3.7E-03	7.5E-03	21.3E-03	56.4E-03	49.6E-03	76.1E-03	79.2E-03	1.6E-03	9.1E-03	48.7E-03	12.3E-03
Sigma	-	6.7E-03	3.9E-03	7.3E-03	4.2E-03	10.1E-03	37.5E-03	18.5E-03	29.6E-03	4.7E-03	7.2E-03	20.3E-03	12.3E-03

Hirex Engineering	Total Dose Radiation Test Report								Ref.:	HRX/TID/1012
	2N5154				Microsemi				Issue:	01

**Measurements**

VBE(SAT)1	0 kRad	8.1 kRad	22.5 kRad	53.1 kRad	108.9 kRad	162.9 kRad	204.3 kRad	255.6 kRad	305.1 kRad	351 kRad	396 kRad	24 Hours	168 Hours
21_REF	0.928	0.960	0.926	0.922	0.965	0.964	0.932	0.956	0.977	0.934	0.962	0.948	0.917
OFF POTON samples													
26	1.001	1.001	1.011	1.008	1.023	1.030	1.037	1.041	1.060	1.008	1.032	1.012	1.004
27	1.004	1.009	1.013	1.009	1.068	1.080	1.065	1.034	1.013	1.003	1.007	1.028	1.001
28	1.002	1.001	1.006	1.002	1.016	1.041	1.032	1.058	1.038	1.018	1.011	1.061	1.011
Statistics													
Min	1.001	1.001	1.006	1.002	1.016	1.030	1.032	1.034	1.013	1.003	1.007	1.012	1.001
Max	1.004	1.009	1.013	1.009	1.068	1.080	1.065	1.058	1.060	1.018	1.032	1.061	1.011
Average	1.002	1.004	1.010	1.006	1.036	1.050	1.045	1.044	1.037	1.010	1.017	1.034	1.005
Sigma	0.001	0.004	0.003	0.003	0.023	0.021	0.014	0.010	0.019	0.006	0.011	0.020	0.004

**Drift Calculation**

VBE(SAT)1	0 kRad	8.1 kRad	22.5 kRad	53.1 kRad	108.9 kRad	162.9 kRad	204.3 kRad	255.6 kRad	305.1 kRad	351 kRad	396 kRad	24 Hours	168 Hours
OFF POTON samples													
26	-	0.0E+00	10.0E-03	6.8E-03	22.4E-03	29.2E-03	36.4E-03	40.4E-03	59.2E-03	6.8E-03	31.6E-03	11.6E-03	2.8E-03
27	-	5.2E-03	9.6E-03	5.2E-03	64.4E-03	76.0E-03	61.2E-03	30.0E-03	9.2E-03	-399.9E-06	3.2E-03	24.0E-03	-2.4E-03
28	-	-300.0E-06	4.4E-03	800.0E-06	14.0E-03	39.6E-03	30.4E-03	56.4E-03	36.8E-03	16.4E-03	9.6E-03	59.6E-03	9.6E-03
Average	-	1.6E-03	8.0E-03	4.3E-03	33.6E-03	48.3E-03	42.7E-03	42.3E-03	35.1E-03	7.6E-03	14.8E-03	31.7E-03	3.3E-03
Sigma	-	2.5E-03	2.6E-03	2.5E-03	22.0E-03	20.1E-03	13.3E-03	10.9E-03	20.4E-03	6.9E-03	12.2E-03	20.3E-03	4.9E-03

**Measurements**

VBE(SAT)1	0 kRad	8.1 kRad	22.5 kRad	53.1 kRad	108.9 kRad	162.9 kRad	204.3 kRad	255.6 kRad	305.1 kRad	351 kRad	396 kRad	24 Hours	168 Hours
21_REF	0.928	0.960	0.926	0.922	0.965	0.964	0.932	0.956	0.977	0.934	0.962	0.948	0.917
OFF TID samples													
33	0.995	0.995	1.004	0.994	1.006	1.006	1.014	1.088	1.054	0.998	1.000	1.028	0.999
34	0.999	1.001	1.002	1.002	1.030	1.025	1.002	1.034	1.042	0.998	1.011	1.023	1.010
36	0.999	1.003	1.006	1.004	1.012	1.006	1.011	1.029	1.029	0.998	1.018	1.015	1.026
Statistics													
Min	0.995	0.995	1.002	0.994	1.006	1.006	1.002	1.029	1.029	0.998	1.000	1.015	0.999
Max	0.999	1.003	1.006	1.004	1.030	1.025	1.014	1.088	1.054	0.998	1.018	1.028	1.026
Average	0.998	1.000	1.004	1.000	1.016	1.012	1.009	1.050	1.042	0.998	1.010	1.022	1.011
Sigma	0.002	0.004	0.001	0.005	0.010	0.009	0.005	0.026	0.010	0.000	0.007	0.005	0.011

**Drift Calculation**

VBE(SAT)1	0 kRad	8.1 kRad	22.5 kRad	53.1 kRad	108.9 kRad	162.9 kRad	204.3 kRad	255.6 kRad	305.1 kRad	351 kRad	396 kRad	24 Hours	168 Hours
OFF TID samples													
33	-	0.0E+00	9.6E-03	-1.2E-03	11.6E-03	11.6E-03	19.2E-03	92.8E-03	59.6E-03	2.8E-03	5.6E-03	32.8E-03	4.0E-03
34	-	2.0E-03	2.8E-03	2.8E-03	30.4E-03	25.6E-03	2.4E-03	35.2E-03	42.4E-03	-1.2E-03	11.6E-03	23.6E-03	10.8E-03
36	-	4.0E-03	6.4E-03	4.8E-03	12.8E-03	6.8E-03	11.6E-03	30.0E-03	29.6E-03	-800.0E-06	19.2E-03	16.0E-03	26.4E-03
Average	-	2.0E-03	6.3E-03	2.1E-03	18.3E-03	14.7E-03	11.1E-03	52.7E-03	43.9E-03	266.7E-06	12.1E-03	24.1E-03	13.7E-03
Sigma	-	1.6E-03	2.8E-03	2.5E-03	8.6E-03	8.0E-03	6.9E-03	28.5E-03	12.3E-03	1.8E-03	5.6E-03	6.9E-03	9.4E-03

Parameter : Base-Emitter Saturation Voltage : VBE(SAT)2

Test conditions : IC=5A. IB=500mA

Unit : V

Spec Limit Max : 2.200

Spec limits are represented in bold lines on the graphic.

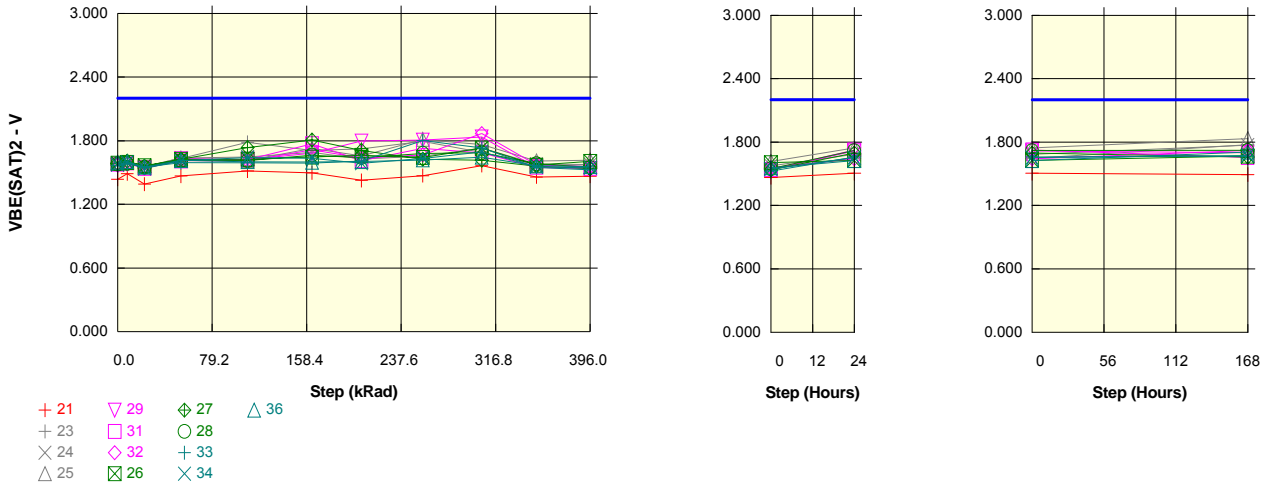

Measurements

VBE(SAT)2	0 kRad	8.1 kRad	22.5 kRad	53.1 kRad	108.9 kRad	162.9 kRad	204.3 kRad	255.6 kRad	305.1 kRad	351 kRad	396 kRad	24 Hours	168 Hours
21_REF	1.438	1.489	1.391	1.468	1.515	1.497	1.428	1.471	1.566	1.459	1.466	1.506	1.492
ON PROTON samples													
23	1.584	1.590	1.549	1.634	1.785	1.708	1.723	1.796	1.690	1.573	1.558	1.648	1.777
24	1.579	1.590	1.554	1.637	1.648	1.690	1.628	1.655	1.730	1.580	1.576	1.686	1.770
25	1.587	1.596	1.554	1.636	1.613	1.729	1.657	1.812	1.765	1.610	1.617	1.745	1.834
Statistics													
Min	1.579	1.590	1.549	1.634	1.613	1.690	1.628	1.655	1.690	1.573	1.558	1.648	1.770
Max	1.587	1.596	1.554	1.637	1.785	1.729	1.723	1.812	1.765	1.610	1.617	1.745	1.834
Average	1.583	1.592	1.552	1.636	1.682	1.709	1.669	1.754	1.728	1.588	1.584	1.693	1.794
Sigma	0.003	0.003	0.003	0.001	0.074	0.016	0.040	0.071	0.031	0.016	0.024	0.040	0.028

Drift Calculation

VBE(SAT)2	0 kRad	8.1 kRad	22.5 kRad	53.1 kRad	108.9 kRad	162.9 kRad	204.3 kRad	255.6 kRad	305.1 kRad	351 kRad	396 kRad	24 Hours	168 Hours
ON PROTON samples													
23	-	6.4E-03	-34.8E-03	50.4E-03	201.6E-03	124.8E-03	139.2E-03	212.0E-03	106.0E-03	-10.4E-03	-25.2E-03	64.4E-03	193.2E-03
24	-	10.8E-03	-25.2E-03	58.0E-03	68.4E-03	110.4E-03	48.4E-03	75.6E-03	151.2E-03	800.0E-06	-2.8E-03	106.4E-03	191.2E-03
25	-	8.8E-03	-32.8E-03	49.2E-03	26.0E-03	141.6E-03	70.0E-03	225.2E-03	177.6E-03	22.8E-03	29.6E-03	158.0E-03	246.4E-03
Average	-	8.7E-03	-30.9E-03	52.5E-03	98.7E-03	125.6E-03	85.9E-03	170.9E-03	144.9E-03	4.4E-03	533.3E-06	109.6E-03	210.3E-03
Sigma	-	1.8E-03	4.1E-03	3.9E-03	74.8E-03	12.7E-03	38.7E-03	67.6E-03	29.6E-03	13.8E-03	22.5E-03	38.3E-03	25.6E-03

Measurements

VBE(SAT)2	0 kRad	8.1 kRad	22.5 kRad	53.1 kRad	108.9 kRad	162.9 kRad	204.3 kRad	255.6 kRad	305.1 kRad	351 kRad	396 kRad	24 Hours	168 Hours
21_REF	1.438	1.489	1.391	1.468	1.515	1.497	1.428	1.471	1.566	1.459	1.466	1.506	1.492
ON TID samples													
29	1.567	1.592	1.545	1.631	1.624	1.683	1.797	1.807	1.836	1.550	1.540	1.717	1.699
31	1.580	1.591	1.542	1.611	1.624	1.771	1.612	1.727	1.686	1.550	1.542	1.726	1.655
32	1.570	1.582	1.541	1.614	1.610	1.714	1.637	1.665	1.868	1.574	1.557	1.643	1.721
Statistics													
Min	1.567	1.582	1.541	1.611	1.610	1.683	1.612	1.665	1.686	1.550	1.540	1.643	1.655
Max	1.580	1.592	1.545	1.631	1.624	1.771	1.797	1.807	1.868	1.574	1.557	1.726	1.721
Average	1.572	1.588	1.543	1.619	1.619	1.723	1.682	1.733	1.797	1.558	1.546	1.695	1.692
Sigma	0.006	0.005	0.002	0.009	0.007	0.037	0.082	0.058	0.079	0.011	0.008	0.037	0.027

Drift Calculation

VBE(SAT)2	0 kRad	8.1 kRad	22.5 kRad	53.1 kRad	108.9 kRad	162.9 kRad	204.3 kRad	255.6 kRad	305.1 kRad	351 kRad	396 kRad	24 Hours	168 Hours
ON TID samples													
29	-	24.8E-03	-22.0E-03	64.0E-03	57.2E-03	116.0E-03	230.4E-03	240.0E-03	269.2E-03	-17.2E-03	-27.2E-03	150.0E-03	132.4E-03
31	-	11.2E-03	-38.4E-03	31.2E-03	44.0E-03	191.2E-03	32.0E-03	147.2E-03	106.0E-03	-30.4E-03	-38.0E-03	146.0E-03	75.2E-03
32	-	11.2E-03	-29.2E-03	43.6E-03	39.2E-03	143.2E-03	66.8E-03	94.8E-03	298.0E-03	3.2E-03	-13.2E-03	72.4E-03	150.8E-03
Average	-	15.7E-03	-29.9E-03	46.3E-03	46.8E-03	150.1E-03	109.7E-03	160.7E-03	224.4E-03	-14.8E-03	-26.1E-03	122.8E-03	119.5E-03
Sigma	-	6.4E-03	6.7E-03	13.5E-03	7.6E-03	31.1E-03	86.5E-03	60.0E-03	84.5E-03	13.8E-03	10.2E-03	35.7E-03	32.2E-03

Hirex Engineering	Total Dose Radiation Test Report								Ref.:	HRX/TID/1012
	2N5154				Microsemi				Issue:	01

**Measurements**

VBE(SAT)2	0 kRad	8.1 kRad	22.5 kRad	53.1 kRad	108.9 kRad	162.9 kRad	204.3 kRad	255.6 kRad	305.1 kRad	351 kRad	396 kRad	24 Hours	168 Hours
21_REF	1.438	1.489	1.391	1.468	1.515	1.497	1.428	1.471	1.566	1.459	1.466	1.506	1.492
OFF POTON samples													
26	1.588	1.596	1.565	1.624	1.626	1.646	1.663	1.643	1.731	1.570	1.606	1.627	1.668
27	1.587	1.608	1.559	1.625	1.736	1.807	1.710	1.626	1.617	1.562	1.538	1.696	1.659
28	1.581	1.586	1.551	1.614	1.613	1.665	1.640	1.681	1.688	1.584	1.549	1.721	1.722
Statistics													
Min	1.581	1.586	1.551	1.614	1.613	1.646	1.640	1.626	1.617	1.562	1.538	1.627	1.659
Max	1.588	1.608	1.565	1.625	1.736	1.807	1.710	1.681	1.731	1.584	1.606	1.721	1.722
Average	1.585	1.597	1.558	1.621	1.658	1.706	1.671	1.650	1.679	1.572	1.564	1.681	1.683
Sigma	0.003	0.009	0.006	0.005	0.055	0.072	0.029	0.023	0.047	0.009	0.029	0.040	0.028

**Drift Calculation**

VBE(SAT)2	0 kRad	8.1 kRad	22.5 kRad	53.1 kRad	108.9 kRad	162.9 kRad	204.3 kRad	255.6 kRad	305.1 kRad	351 kRad	396 kRad	24 Hours	168 Hours
OFF POTON samples													
26	-	8.8E-03	-22.4E-03	36.8E-03	38.4E-03	58.8E-03	75.6E-03	55.6E-03	143.2E-03	-17.2E-03	18.0E-03	39.6E-03	80.0E-03
27	-	21.2E-03	-28.0E-03	38.0E-03	149.2E-03	220.4E-03	122.8E-03	39.6E-03	30.0E-03	-24.8E-03	-48.4E-03	109.6E-03	72.4E-03
28	-	5.2E-03	-30.0E-03	32.4E-03	32.0E-03	83.8E-03	58.8E-03	100.0E-03	107.2E-03	2.8E-03	-32.0E-03	139.6E-03	141.2E-03
Average	-	11.7E-03	-26.8E-03	35.7E-03	73.2E-03	120.9E-03	85.7E-03	65.1E-03	93.5E-03	-13.1E-03	-20.8E-03	96.3E-03	97.9E-03
Sigma	-	6.8E-03	3.2E-03	2.4E-03	53.8E-03	71.1E-03	27.1E-03	25.6E-03	47.2E-03	11.6E-03	28.2E-03	41.9E-03	30.8E-03

**Measurements**

VBE(SAT)2	0 kRad	8.1 kRad	22.5 kRad	53.1 kRad	108.9 kRad	162.9 kRad	204.3 kRad	255.6 kRad	305.1 kRad	351 kRad	396 kRad	24 Hours	168 Hours
21_REF	1.438	1.489	1.391	1.468	1.515	1.497	1.428	1.471	1.566	1.459	1.466	1.506	1.492
OFF TID samples													
33	1.569	1.584	1.551	1.594	1.593	1.590	1.608	1.801	1.733	1.550	1.524	1.660	1.669
34	1.575	1.598	1.538	1.611	1.642	1.635	1.588	1.634	1.695	1.555	1.545	1.654	1.674
36	1.597	1.603	1.551	1.616	1.602	1.599	1.604	1.619	1.645	1.563	1.557	1.625	1.706
Statistics													
Min	1.569	1.584	1.538	1.594	1.593	1.590	1.588	1.619	1.645	1.550	1.524	1.625	1.669
Max	1.597	1.603	1.551	1.616	1.642	1.635	1.608	1.801	1.733	1.563	1.557	1.660	1.706
Average	1.581	1.595	1.547	1.607	1.612	1.608	1.600	1.685	1.691	1.556	1.542	1.646	1.683
Sigma	0.012	0.008	0.006	0.009	0.021	0.019	0.009	0.083	0.036	0.005	0.013	0.015	0.017

**Drift Calculation**

VBE(SAT)2	0 kRad	8.1 kRad	22.5 kRad	53.1 kRad	108.9 kRad	162.9 kRad	204.3 kRad	255.6 kRad	305.1 kRad	351 kRad	396 kRad	24 Hours	168 Hours
OFF TID samples													
33	-	14.4E-03	-18.0E-03	25.2E-03	23.6E-03	20.8E-03	39.2E-03	232.0E-03	163.6E-03	-19.6E-03	-44.8E-03	90.8E-03	99.6E-03
34	-	22.8E-03	-36.8E-03	35.6E-03	66.4E-03	59.6E-03	12.8E-03	58.4E-03	120.0E-03	-20.0E-03	-30.0E-03	78.4E-03	99.2E-03
36	-	6.0E-03	-46.4E-03	18.8E-03	5.2E-03	1.6E-03	6.8E-03	21.6E-03	47.6E-03	-34.4E-03	-40.4E-03	27.6E-03	109.2E-03
Average	-	14.4E-03	-33.7E-03	26.5E-03	31.7E-03	27.3E-03	19.6E-03	104.0E-03	110.4E-03	-24.7E-03	-38.4E-03	65.6E-03	102.7E-03
Sigma	-	6.9E-03	11.8E-03	6.9E-03	25.6E-03	24.1E-03	14.1E-03	91.7E-03	47.8E-03	6.9E-03	6.2E-03	27.3E-03	4.6E-03

Parameter : Forward-Current Transfert Ratio : HFE1

Test conditions : IC==50mA. VCE=5V

Unit :

Spec Limit Min : 50.0

Spec limits are represented in bold lines on the graphic.

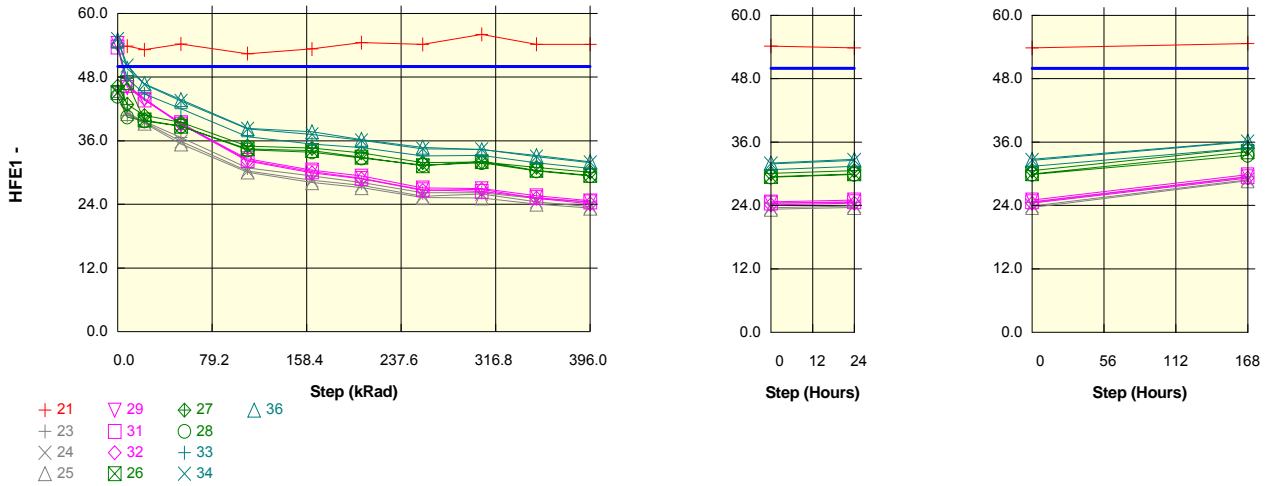

Measurements

HFE1	0 kRad	8.1 kRad	22.5 kRad	53.1 kRad	108.9 kRad	162.9 kRad	204.3 kRad	255.6 kRad	305.1 kRad	351 kRad	396 kRad	24 Hours	168 Hours
21_REF	53.6	53.8	53.2	54.2	52.4	53.3	54.5	54.2	56.1	54.2	54.2	53.8	54.7
ON PROTON samples													
23	46.1	40.8	39.6	36.6	30.9	29.4	28.1	26.2	26.2	25.1	24.5	24.6	29.4
24	45.2	41.3	39.5	35.9	30.3	28.6	27.6	25.6	26.0	24.5	23.6	23.9	28.9
25	45.5	41.1	39.3	35.4	30.1	28.1	27.2	25.3	25.2	24.1	23.3	23.6	28.7
Statistics													
Min	45.2	40.8	39.3	35.4	30.1	28.1	27.2	25.3	25.2	24.1	23.3	23.6	28.7
Max	46.1	41.3	39.6	36.6	30.9	29.4	28.1	26.2	26.2	25.1	24.5	24.6	29.4
Average	45.6	41.1	39.5	36.0	30.4	28.7	27.6	25.7	25.8	24.6	23.8	24.1	29.0
Sigma	0.4	0.2	0.1	0.5	0.3	0.5	0.4	0.4	0.4	0.4	0.5	0.4	0.3

Drift Calculation

HFE1	0 kRad	8.1 kRad	22.5 kRad	53.1 kRad	108.9 kRad	162.9 kRad	204.3 kRad	255.6 kRad	305.1 kRad	351 kRad	396 kRad	24 Hours	168 Hours
ON PROTON samples													
23	-	2.8E-03	3.5E-03	5.6E-03	10.7E-03	12.3E-03	13.9E-03	16.5E-03	16.4E-03	18.1E-03	19.2E-03	19.0E-03	12.3E-03
24	-	2.0E-03	3.2E-03	5.7E-03	10.9E-03	12.9E-03	14.1E-03	17.0E-03	16.4E-03	18.7E-03	20.2E-03	19.6E-03	12.5E-03
25	-	2.3E-03	3.5E-03	6.2E-03	11.3E-03	13.6E-03	14.8E-03	17.6E-03	17.7E-03	19.6E-03	21.0E-03	20.3E-03	12.9E-03
Average	-	2.4E-03	3.4E-03	5.9E-03	10.9E-03	12.9E-03	14.3E-03	17.0E-03	16.8E-03	18.8E-03	20.1E-03	19.6E-03	12.5E-03
Sigma	-	328.4E-06	150.3E-06	279.9E-06	235.2E-06	505.4E-06	406.4E-06	451.1E-06	597.8E-06	606.0E-06	729.5E-06	544.3E-06	248.2E-06

Measurements

HFE1	0 kRad	8.1 kRad	22.5 kRad	53.1 kRad	108.9 kRad	162.9 kRad	204.3 kRad	255.6 kRad	305.1 kRad	351 kRad	396 kRad	24 Hours	168 Hours
21_REF	53.6	53.8	53.2	54.2	52.4	53.3	54.5	54.2	56.1	54.2	54.2	53.8	54.7
ON TID samples													
29	54.4	46.1	43.8	39.1	32.6	30.5	29.4	27.1	27.0	25.6	24.7	25.0	29.8
31	53.7	46.4	43.7	39.4	32.3	30.2	28.9	26.8	26.5	25.3	24.5	24.7	29.5
32	54.3	46.5	44.0	39.1	32.2	29.9	28.8	26.6	26.8	25.2	24.1	24.4	29.2
Statistics													
Min	53.7	46.1	43.7	39.1	32.2	29.9	28.8	26.6	26.5	25.2	24.1	24.4	29.2
Max	54.4	46.5	44.0	39.4	32.6	30.5	29.4	27.1	27.0	25.6	24.7	25.0	29.8
Average	54.1	46.3	43.8	39.2	32.4	30.2	29.0	26.8	26.7	25.4	24.4	24.7	29.5
Sigma	0.3	0.2	0.1	0.1	0.2	0.2	0.2	0.2	0.2	0.2	0.2	0.2	0.3

Drift Calculation

HFE1	0 kRad	8.1 kRad	22.5 kRad	53.1 kRad	108.9 kRad	162.9 kRad	204.3 kRad	255.6 kRad	305.1 kRad	351 kRad	396 kRad	24 Hours	168 Hours
ON TID samples													
29	-	3.3E-03	4.4E-03	7.2E-03	12.3E-03	14.4E-03	15.7E-03	18.5E-03	18.7E-03	20.6E-03	22.1E-03	21.5E-03	15.1E-03
31	-	2.9E-03	4.3E-03	6.8E-03	12.3E-03	14.5E-03	15.9E-03	18.7E-03	19.2E-03	20.9E-03	22.3E-03	21.9E-03	15.3E-03
32	-	3.1E-03	4.3E-03	7.1E-03	12.6E-03	15.0E-03	16.3E-03	19.1E-03	18.9E-03	21.3E-03	23.0E-03	22.5E-03	15.8E-03
Average	-	3.1E-03	4.3E-03	7.0E-03	12.4E-03	14.6E-03	16.0E-03	18.8E-03	18.9E-03	21.0E-03	22.5E-03	22.0E-03	15.4E-03
Sigma	-	165.9E-06	76.7E-06	185.8E-06	165.7E-06	242.6E-06	240.5E-06	253.3E-06	197.6E-06	271.5E-06	394.8E-06	399.5E-06	284.2E-06

Hirex Engineering	Total Dose Radiation Test Report										Ref.:	HRX/TID/1012
	2N5154					Microsemi					Issue:	01

**Measurements**

HFE1	0 kRad	8.1 kRad	22.5 kRad	53.1 kRad	108.9 kRad	162.9 kRad	204.3 kRad	255.6 kRad	305.1 kRad	351 kRad	396 kRad	24 Hours	168 Hours
21_REF	53.6	53.8	53.2	54.2	52.4	53.3	54.5	54.2	56.1	54.2	54.2	53.8	54.7
OFF POTON samples													
26	45.1	47.0	39.9	38.7	34.5	34.2	32.9	31.3	32.1	30.4	29.5	30.0	34.2
27	46.3	42.9	40.8	39.5	35.0	34.6	33.7	31.9	32.0	31.0	30.1	30.6	34.8
28	44.4	40.5	39.7	38.8	34.3	33.9	32.7	31.4	31.9	30.3	29.4	29.9	33.5
Statistics													
Min	44.4	40.5	39.7	38.7	34.3	33.9	32.7	31.3	31.9	30.3	29.4	29.9	33.5
Max	46.3	47.0	40.8	39.5	35.0	34.6	33.7	31.9	32.1	31.0	30.1	30.6	34.8
Average	45.3	43.4	40.1	39.0	34.6	34.2	33.1	31.5	32.0	30.6	29.6	30.2	34.2
Sigma	0.8	2.7	0.4	0.3	0.3	0.3	0.4	0.3	0.1	0.3	0.3	0.3	0.5

**Drift Calculation**

HFE1	0 kRad	8.1 kRad	22.5 kRad	53.1 kRad	108.9 kRad	162.9 kRad	204.3 kRad	255.6 kRad	305.1 kRad	351 kRad	396 kRad	24 Hours	168 Hours
OFF POTON samples													
26	-	-906.9E-06	2.9E-03	3.6E-03	6.8E-03	7.1E-03	8.2E-03	9.8E-03	9.0E-03	10.7E-03	11.7E-03	11.1E-03	7.1E-03
27	-	1.7E-03	2.9E-03	3.7E-03	7.0E-03	7.3E-03	8.1E-03	9.7E-03	9.7E-03	10.7E-03	11.6E-03	11.1E-03	7.1E-03
28	-	2.2E-03	2.6E-03	3.3E-03	6.6E-03	7.0E-03	8.0E-03	9.3E-03	8.9E-03	10.5E-03	11.5E-03	10.9E-03	7.3E-03
Average	-	1.0E-03	2.8E-03	3.5E-03	6.8E-03	7.1E-03	8.1E-03	9.6E-03	9.2E-03	10.6E-03	11.6E-03	11.0E-03	7.2E-03
Sigma	-	1.4E-03	130.9E-06	204.5E-06	132.4E-06	126.4E-06	78.1E-06	225.0E-06	360.2E-06	98.6E-06	97.8E-06	90.8E-06	101.2E-06

**Measurements**

HFE1	0 kRad	8.1 kRad	22.5 kRad	53.1 kRad	108.9 kRad	162.9 kRad	204.3 kRad	255.6 kRad	305.1 kRad	351 kRad	396 kRad	24 Hours	168 Hours
21_REF	53.6	53.8	53.2	54.2	52.4	53.3	54.5	54.2	56.1	54.2	54.2	53.8	54.7
OFF TID samples													
33	53.5	47.8	44.8	42.0	36.7	35.4	34.7	33.1	33.2	31.8	30.8	31.4	34.9
34	55.2	50.2	46.6	43.5	38.2	37.2	36.1	34.5	34.4	33.0	31.9	32.6	36.1
36	55.0	49.6	46.7	43.8	38.3	37.7	36.2	34.8	34.3	33.2	32.1	32.8	36.2
Statistics													
Min	53.5	47.8	44.8	42.0	36.7	35.4	34.7	33.1	33.2	31.8	30.8	31.4	34.9
Max	55.2	50.2	46.7	43.8	38.3	37.7	36.2	34.8	34.4	33.2	32.1	32.8	36.2
Average	54.6	49.2	46.1	43.1	37.8	36.8	35.7	34.1	34.0	32.7	31.6	32.2	35.7
Sigma	0.8	1.0	0.9	0.8	0.7	1.0	0.7	0.7	0.5	0.6	0.6	0.6	0.6

**Drift Calculation**

HFE1	0 kRad	8.1 kRad	22.5 kRad	53.1 kRad	108.9 kRad	162.9 kRad	204.3 kRad	255.6 kRad	305.1 kRad	351 kRad	396 kRad	24 Hours	168 Hours
OFF TID samples													
33	-	2.2E-03	3.6E-03	5.1E-03	8.5E-03	9.6E-03	10.1E-03	11.5E-03	11.4E-03	12.7E-03	13.8E-03	13.1E-03	10.0E-03
34	-	1.8E-03	3.3E-03	4.9E-03	8.0E-03	8.8E-03	9.6E-03	10.9E-03	11.0E-03	12.2E-03	13.2E-03	12.6E-03	9.6E-03
36	-	2.0E-03	3.2E-03	4.7E-03	7.9E-03	8.4E-03	9.4E-03	10.6E-03	11.0E-03	11.9E-03	13.0E-03	12.4E-03	9.5E-03
Average	-	2.0E-03	3.4E-03	4.9E-03	8.2E-03	8.9E-03	9.7E-03	11.0E-03	11.1E-03	12.3E-03	13.3E-03	12.7E-03	9.7E-03
Sigma	-	177.7E-06	165.8E-06	166.1E-06	255.9E-06	500.6E-06	284.5E-06	361.7E-06	206.7E-06	322.1E-06	319.5E-06	329.9E-06	210.0E-06



Parameter : Forward-Current Transfert Ratio : HFE2  
 Test conditions : IC=2.5A. VCE=5V  
 Unit :  
 Spec Limit Min : 70.00  
 Spec Limit Max : 200.00  
 Spec limits are represented in bold lines on the graphic.

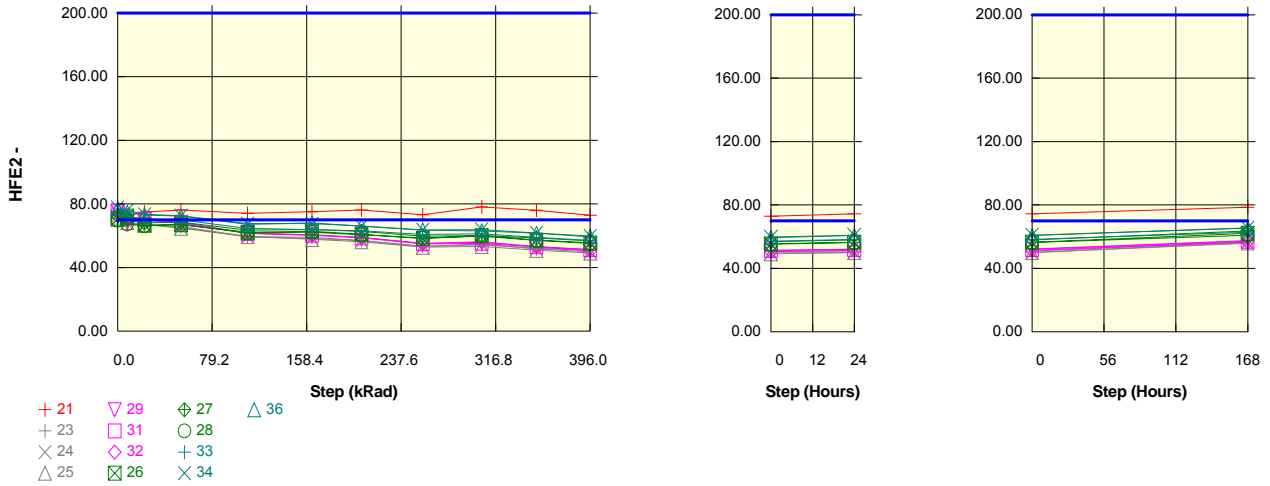

Measurements

HFE2	0 kRad	8.1 kRad	22.5 kRad	53.1 kRad	108.9 kRad	162.9 kRad	204.3 kRad	255.6 kRad	305.1 kRad	351 kRad	396 kRad	24 Hours	168 Hours
21_REF	75.26	72.76	74.94	76.20	74.14	75.14	76.29	73.16	78.17	76.15	72.95	74.50	78.69
ON PROTON samples													
23	71.38	67.02	66.74	65.90	59.55	59.11	57.04	53.57	54.27	52.06	50.72	50.97	56.62
24	71.03	67.83	67.29	65.34	59.34	58.35	57.00	53.15	54.87	51.79	49.80	49.95	56.33
25	71.77	68.35	67.25	64.78	59.51	57.74	56.26	52.79	53.30	50.93	49.15	49.95	55.91
Statistics													
Min	71.03	67.02	66.74	64.78	59.34	57.74	56.26	52.79	53.30	50.93	49.15	49.95	55.91
Max	71.77	68.35	67.29	65.90	59.55	59.11	57.04	53.57	54.87	52.06	50.72	50.97	56.62
Average	71.39	67.73	67.09	65.34	59.47	58.40	56.77	53.17	54.15	51.60	49.89	50.29	56.29
Sigma	0.30	0.55	0.25	0.45	0.09	0.56	0.36	0.32	0.64	0.48	0.64	0.48	0.29

Drift Calculation

HFE2	0 kRad	8.1 kRad	22.5 kRad	53.1 kRad	108.9 kRad	162.9 kRad	204.3 kRad	255.6 kRad	305.1 kRad	351 kRad	396 kRad	24 Hours	168 Hours
ON PROTON samples													
23	-	912.4E-06	975.0E-06	1.2E-03	2.8E-03	2.9E-03	3.5E-03	4.7E-03	4.4E-03	5.2E-03	5.7E-03	5.6E-03	3.7E-03
24	-	663.3E-06	781.3E-06	1.2E-03	2.8E-03	3.1E-03	3.5E-03	4.7E-03	4.1E-03	5.2E-03	6.0E-03	5.9E-03	3.7E-03
25	-	696.9E-06	937.4E-06	1.5E-03	2.9E-03	3.4E-03	3.8E-03	5.0E-03	4.8E-03	5.7E-03	6.4E-03	6.1E-03	4.0E-03
Average	-	757.5E-06	897.9E-06	1.3E-03	2.8E-03	3.1E-03	3.6E-03	4.8E-03	4.5E-03	5.4E-03	6.0E-03	5.9E-03	3.8E-03
Sigma	-	110.4E-06	83.9E-06	146.5E-06	44.3E-06	198.3E-06	165.8E-06	151.3E-06	280.1E-06	230.4E-06	289.4E-06	200.3E-06	136.1E-06

Measurements

HFE2	0 kRad	8.1 kRad	22.5 kRad	53.1 kRad	108.9 kRad	162.9 kRad	204.3 kRad	255.6 kRad	305.1 kRad	351 kRad	396 kRad	24 Hours	168 Hours
21_REF	75.26	72.76	74.94	76.20	74.14	75.14	76.29	73.16	78.17	76.15	72.95	74.50	78.69
ON TID samples													
29	75.71	68.28	70.09	67.77	61.69	60.63	59.09	55.25	55.83	53.30	51.31	52.16	57.64
31	75.24	71.25	70.24	68.51	61.48	60.50	58.70	55.01	55.31	53.05	51.42	52.04	57.12
32	76.07	71.63	70.83	68.51	61.68	60.34	58.89	55.03	56.39	52.90	50.68	51.47	56.67
Statistics													
Min	75.24	68.28	70.09	67.77	61.48	60.34	58.70	55.01	55.31	52.90	50.68	51.47	56.67
Max	76.07	71.63	70.83	68.51	61.69	60.63	59.09	55.25	56.39	53.30	51.42	52.16	57.64
Average	75.67	70.39	70.38	68.26	61.62	60.49	58.89	55.10	55.84	53.08	51.14	51.89	57.14
Sigma	0.34	1.50	0.32	0.35	0.10	0.12	0.16	0.11	0.44	0.17	0.32	0.30	0.40

Drift Calculation

HFE2	0 kRad	8.1 kRad	22.5 kRad	53.1 kRad	108.9 kRad	162.9 kRad	204.3 kRad	255.6 kRad	305.1 kRad	351 kRad	396 kRad	24 Hours	168 Hours
ON TID samples													
29	-	1.4E-03	1.1E-03	1.5E-03	3.0E-03	3.3E-03	3.7E-03	4.9E-03	4.7E-03	5.6E-03	6.3E-03	6.0E-03	4.1E-03
31	-	742.6E-06	945.5E-06	1.3E-03	3.0E-03	3.2E-03	3.7E-03	4.9E-03	4.8E-03	5.6E-03	6.2E-03	5.9E-03	4.2E-03
32	-	815.2E-06	972.9E-06	1.5E-03	3.1E-03	3.4E-03	3.8E-03	5.0E-03	4.6E-03	5.8E-03	6.6E-03	6.3E-03	4.5E-03
Average	-	998.2E-06	992.4E-06	1.4E-03	3.0E-03	3.3E-03	3.8E-03	4.9E-03	4.7E-03	5.6E-03	6.3E-03	6.1E-03	4.3E-03
Sigma	-	311.5E-06	48.2E-06	99.7E-06	38.5E-06	79.7E-06	50.9E-06	63.8E-06	82.6E-06	94.7E-06	179.5E-06	161.5E-06	155.8E-06

Hirex Engineering	Total Dose Radiation Test Report										Ref.:	HRX/TID/1012
	2N5154					Microsemi					Issue:	01

**Measurements**

HFE2	0 kRad	8.1 kRad	22.5 kRad	53.1 kRad	108.9 kRad	162.9 kRad	204.3 kRad	255.6 kRad	305.1 kRad	351 kRad	396 kRad	24 Hours	168 Hours
21_REF	75.26	72.76	74.94	76.20	74.14	75.14	76.29	73.16	78.17	76.15	72.95	74.50	78.69
OFF_POTON samples													
26	70.59	72.37	66.57	67.00	62.19	62.93	61.05	58.31	60.11	57.32	55.50	56.52	62.11
27	72.57	70.24	68.07	68.58	63.46	63.99	62.79	59.77	60.15	58.67	56.90	57.94	63.73
28	69.85	67.46	66.37	67.11	61.80	62.31	60.64	58.61	59.71	57.09	55.28	56.33	61.00
Statistics													
Min	69.85	67.46	66.37	67.00	61.80	62.31	60.64	58.31	59.71	57.09	55.28	56.33	61.00
Max	72.57	72.37	68.07	68.58	63.46	63.99	62.79	59.77	60.15	58.67	56.90	57.94	63.73
Average	71.00	70.02	67.00	67.56	62.48	63.08	61.49	58.90	59.99	57.69	55.89	56.93	62.28
Sigma	1.15	2.01	0.76	0.72	0.71	0.69	0.93	0.63	0.20	0.70	0.72	0.72	1.12

**Drift Calculation**

HFE2	0 kRad	8.1 kRad	22.5 kRad	53.1 kRad	108.9 kRad	162.9 kRad	204.3 kRad	255.6 kRad	305.1 kRad	351 kRad	396 kRad	24 Hours	168 Hours
OFF_POTON samples													
26	-	-349.0E-06	856.2E-06	759.2E-06	1.9E-03	1.7E-03	2.2E-03	3.0E-03	2.5E-03	3.3E-03	3.9E-03	3.5E-03	1.9E-03
27	-	457.4E-06	910.1E-06	801.9E-06	2.0E-03	1.8E-03	2.1E-03	2.9E-03	2.8E-03	3.3E-03	3.8E-03	3.5E-03	1.9E-03
28	-	508.0E-06	751.5E-06	583.4E-06	1.9E-03	1.7E-03	2.2E-03	2.7E-03	2.4E-03	3.2E-03	3.8E-03	3.4E-03	2.1E-03
Average	-	205.5E-06	839.3E-06	714.8E-06	1.9E-03	1.8E-03	2.2E-03	2.9E-03	2.6E-03	3.2E-03	3.8E-03	3.5E-03	2.0E-03
Sigma	-	392.6E-06	65.8E-06	94.6E-06	47.1E-06	56.6E-06	28.4E-06	105.5E-06	187.0E-06	35.3E-06	34.3E-06	36.5E-06	73.2E-06

**Measurements**

HFE2	0 kRad	8.1 kRad	22.5 kRad	53.1 kRad	108.9 kRad	162.9 kRad	204.3 kRad	255.6 kRad	305.1 kRad	351 kRad	396 kRad	24 Hours	168 Hours
21_REF	75.26	72.76	74.94	76.20	74.14	75.14	76.29	73.16	78.17	76.15	72.95	74.50	78.69
OFF_TID samples													
33	74.93	72.21	70.41	69.96	64.65	63.81	63.16	60.76	61.25	59.04	57.15	58.33	62.88
34	77.74	75.89	73.54	72.65	67.65	67.63	66.19	63.73	63.89	61.77	59.78	61.02	65.52
36	77.05	74.75	73.07	72.42	67.26	68.08	66.04	63.54	63.07	61.54	59.44	60.79	65.37
Statistics													
Min	74.93	72.21	70.41	69.96	64.65	63.81	63.16	60.76	61.25	59.04	57.15	58.33	62.88
Max	77.74	75.89	73.54	72.65	67.65	68.08	66.19	63.73	63.89	61.77	59.78	61.02	65.52
Average	76.58	74.28	72.34	71.68	66.52	66.51	65.13	62.67	62.74	60.78	58.79	60.05	64.59
Sigma	1.20	1.54	1.38	1.22	1.33	1.92	1.39	1.36	1.10	1.24	1.17	1.22	1.21

**Drift Calculation**

HFE2	0 kRad	8.1 kRad	22.5 kRad	53.1 kRad	108.9 kRad	162.9 kRad	204.3 kRad	255.6 kRad	305.1 kRad	351 kRad	396 kRad	24 Hours	168 Hours
OFF_TID samples													
33	-	503.2E-06	856.8E-06	947.1E-06	2.1E-03	2.3E-03	2.5E-03	3.1E-03	3.0E-03	3.6E-03	4.2E-03	3.8E-03	2.6E-03
34	-	313.8E-06	735.2E-06	901.3E-06	1.9E-03	1.9E-03	2.2E-03	2.8E-03	2.8E-03	3.3E-03	3.9E-03	3.5E-03	2.4E-03
36	-	400.7E-06	707.8E-06	830.6E-06	1.9E-03	1.7E-03	2.2E-03	2.8E-03	2.9E-03	3.3E-03	3.8E-03	3.5E-03	2.3E-03
Average	-	405.9E-06	766.6E-06	893.0E-06	2.0E-03	2.0E-03	2.3E-03	2.9E-03	2.9E-03	3.4E-03	4.0E-03	3.6E-03	2.4E-03
Sigma	-	77.4E-06	64.7E-06	47.9E-06	102.5E-06	254.8E-06	136.6E-06	152.8E-06	78.6E-06	140.3E-06	141.0E-06	142.7E-06	99.0E-06

**Parameter : Forward-Current Transfert Ratio : HFE3**

Test conditions : IC=5A. VCE=5V

Unit :

Spec Limit Min : 40.00

Spec limits are represented in bold lines on the graphic.

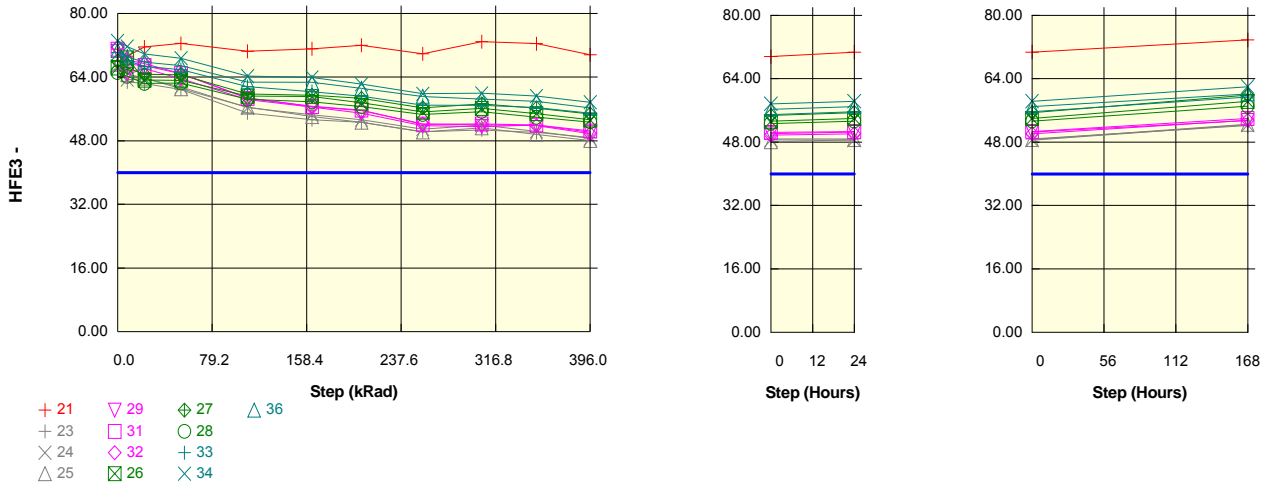

**Measurements**

HFE3	0 kRad	8.1 kRad	22.5 kRad	53.1 kRad	108.9 kRad	162.9 kRad	204.3 kRad	255.6 kRad	305.1 kRad	351 kRad	396 kRad	24 Hours	168 Hours
21_REF	71.02	69.25	71.60	72.46	70.51	71.10	72.00	69.88	72.92	72.40	69.62	70.72	73.82
ON PROTON samples													
23	65.77	62.81	62.37	60.94	55.02	53.29	52.64	50.30	50.75	50.08	48.80	48.84	52.18
24	66.77	63.33	63.64	61.53	56.32	54.57	53.31	50.93	51.96	50.37	48.56	48.52	52.36
25	67.22	64.70	63.75	61.10	56.43	54.08	52.64	50.20	51.24	49.61	48.09	48.63	52.50
Statistics													
Min	65.77	62.81	62.37	60.94	55.02	53.29	52.64	50.20	50.75	49.61	48.09	48.52	52.18
Max	67.22	64.70	63.75	61.53	56.43	54.57	53.31	50.93	51.96	50.37	48.80	48.84	52.50
Average	66.59	63.62	63.25	61.19	55.92	53.98	52.86	50.48	51.32	50.02	48.48	48.67	52.35
Sigma	0.61	0.80	0.63	0.25	0.64	0.53	0.31	0.32	0.49	0.31	0.30	0.13	0.13

**Drift Calculation**

HFE3	0 kRad	8.1 kRad	22.5 kRad	53.1 kRad	108.9 kRad	162.9 kRad	204.3 kRad	255.6 kRad	305.1 kRad	351 kRad	396 kRad	24 Hours	168 Hours
ON PROTON samples													
23	-	715.4E-06	828.6E-06	1.2E-03	3.0E-03	3.6E-03	3.8E-03	4.7E-03	4.5E-03	4.8E-03	5.3E-03	5.3E-03	4.0E-03
24	-	813.8E-06	738.1E-06	1.3E-03	2.8E-03	3.3E-03	3.8E-03	4.7E-03	4.3E-03	4.9E-03	5.6E-03	5.6E-03	4.1E-03
25	-	579.5E-06	810.2E-06	1.5E-03	2.8E-03	3.6E-03	4.1E-03	5.0E-03	4.6E-03	5.3E-03	5.9E-03	5.7E-03	4.2E-03
Average	-	702.9E-06	792.3E-06	1.3E-03	2.9E-03	3.5E-03	3.9E-03	4.8E-03	4.5E-03	5.0E-03	5.6E-03	5.5E-03	4.1E-03
Sigma	-	96.0E-06	39.0E-06	121.6E-06	79.3E-06	115.8E-06	156.6E-06	177.1E-06	151.6E-06	221.8E-06	259.4E-06	185.5E-06	90.9E-06

**Measurements**

HFE3	0 kRad	8.1 kRad	22.5 kRad	53.1 kRad	108.9 kRad	162.9 kRad	204.3 kRad	255.6 kRad	305.1 kRad	351 kRad	396 kRad	24 Hours	168 Hours
21_REF	71.02	69.25	71.60	72.46	70.51	71.10	72.00	69.88	72.92	72.40	69.62	70.72	73.82
ON TID samples													
29	70.49	64.76	66.15	63.67	58.39	56.46	54.91	51.80	51.59	51.95	50.15	50.57	53.47
31	71.01	67.29	66.92	64.89	58.68	56.63	55.71	52.15	52.24	51.97	50.48	50.70	54.00
32	71.56	68.31	67.42	64.87	58.84	56.59	55.55	52.24	52.00	51.80	49.77	50.10	53.52
Statistics													
Min	70.49	64.76	66.15	63.67	58.39	56.46	54.91	51.80	51.59	51.80	49.77	50.10	53.47
Max	71.56	68.31	67.42	64.89	58.84	56.63	55.71	52.24	52.24	51.97	50.48	50.70	54.00
Average	71.02	66.79	66.83	64.47	58.64	56.56	55.39	52.06	51.94	51.91	50.13	50.45	53.67
Sigma	0.44	1.49	0.52	0.57	0.19	0.07	0.35	0.19	0.27	0.07	0.29	0.26	0.24

**Drift Calculation**

HFE3	0 kRad	8.1 kRad	22.5 kRad	53.1 kRad	108.9 kRad	162.9 kRad	204.3 kRad	255.6 kRad	305.1 kRad	351 kRad	396 kRad	24 Hours	168 Hours
ON TID samples													
29	-	1.3E-03	930.4E-06	1.5E-03	2.9E-03	3.5E-03	4.0E-03	5.1E-03	5.2E-03	5.1E-03	5.8E-03	5.6E-03	4.5E-03
31	-	779.4E-06	860.7E-06	1.3E-03	3.0E-03	3.6E-03	3.9E-03	5.1E-03	5.1E-03	5.2E-03	5.7E-03	5.6E-03	4.4E-03
32	-	665.4E-06	859.6E-06	1.4E-03	3.0E-03	3.7E-03	4.0E-03	5.2E-03	5.3E-03	5.3E-03	6.1E-03	6.0E-03	4.7E-03
Average	-	900.0E-06	883.6E-06	1.4E-03	3.0E-03	3.6E-03	4.0E-03	5.1E-03	5.2E-03	5.2E-03	5.9E-03	5.7E-03	4.6E-03
Sigma	-	255.5E-06	33.1E-06	78.8E-06	34.8E-06	72.9E-06	75.4E-06	30.9E-06	83.4E-06	110.6E-06	178.0E-06	175.8E-06	116.2E-06

Hirex Engineering	Total Dose Radiation Test Report									Ref.:	HRX/TID/1012		
	2N5154					Microsemi				Issue:	01		

**Measurements**

HFE3	0 kRad	8.1 kRad	22.5 kRad	53.1 kRad	108.9 kRad	162.9 kRad	204.3 kRad	255.6 kRad	305.1 kRad	351 kRad	396 kRad	24 Hours	168 Hours
21_REF	71.02	69.25	71.60	72.46	70.51	71.10	72.00	69.88	72.92	72.40	69.62	70.72	73.82
OFF POTON samples													
26	66.28	68.81	63.25	63.21	59.25	59.12	57.53	55.24	56.12	54.81	53.27	53.99	58.28
27	68.12	66.41	64.71	64.63	59.77	59.43	58.65	56.29	57.28	56.23	54.72	55.44	59.89
28	65.12	64.22	62.42	62.50	58.41	57.77	56.61	54.60	55.32	53.91	52.72	53.31	57.06
Statistics													
Min	65.12	64.22	62.42	62.50	58.41	57.77	56.61	54.60	55.32	53.91	52.72	53.31	57.06
Max	68.12	68.81	64.71	64.63	59.77	59.43	58.65	56.29	57.28	56.23	54.72	55.44	59.89
Average	66.51	66.48	63.46	63.45	59.14	58.77	57.60	55.38	56.24	54.98	53.57	54.25	58.41
Sigma	1.24	1.88	0.95	0.88	0.56	0.72	0.84	0.70	0.81	0.95	0.84	0.89	1.16

**Drift Calculation**

HFE3	0 kRad	8.1 kRad	22.5 kRad	53.1 kRad	108.9 kRad	162.9 kRad	204.3 kRad	255.6 kRad	305.1 kRad	351 kRad	396 kRad	24 Hours	168 Hours
OFF POTON samples													
26	-	-554.4E-06	724.7E-06	734.7E-06	1.8E-03	1.8E-03	2.3E-03	3.0E-03	2.7E-03	3.2E-03	3.7E-03	3.4E-03	2.1E-03
27	-	378.8E-06	773.6E-06	793.4E-06	2.1E-03	2.1E-03	2.4E-03	3.1E-03	2.8E-03	3.1E-03	3.6E-03	3.4E-03	2.0E-03
28	-	215.8E-06	663.5E-06	642.0E-06	1.8E-03	2.0E-03	2.3E-03	3.0E-03	2.7E-03	3.2E-03	3.6E-03	3.4E-03	2.2E-03
Average	-	13.4E-06	720.6E-06	723.4E-06	1.9E-03	2.0E-03	2.3E-03	3.0E-03	2.7E-03	3.2E-03	3.6E-03	3.4E-03	2.1E-03
Sigma	-	407.0E-06	45.0E-06	62.3E-06	129.0E-06	131.3E-06	32.1E-06	51.4E-06	25.0E-06	36.1E-06	38.7E-06	32.5E-06	61.9E-06

**Measurements**

HFE3	0 kRad	8.1 kRad	22.5 kRad	53.1 kRad	108.9 kRad	162.9 kRad	204.3 kRad	255.6 kRad	305.1 kRad	351 kRad	396 kRad	24 Hours	168 Hours
21_REF	71.02	69.25	71.60	72.46	70.51	71.10	72.00	69.88	72.92	72.40	69.62	70.72	73.82
OFF TID samples													
33	70.21	68.17	66.69	65.90	61.61	60.35	59.18	56.94	56.92	56.32	54.92	55.67	59.36
34	73.12	71.68	69.85	68.77	64.27	63.92	62.22	59.82	59.94	59.24	57.68	58.32	62.02
36	70.77	69.08	67.76	66.92	62.77	62.69	61.14	59.14	58.49	57.90	56.27	56.95	60.15
Statistics													
Min	70.21	68.17	66.69	65.90	61.61	60.35	59.18	56.94	56.92	56.32	54.92	55.67	59.36
Max	73.12	71.68	69.85	68.77	64.27	63.92	62.22	59.82	59.94	59.24	57.68	58.32	62.02
Average	71.36	69.64	68.10	67.19	62.88	62.32	60.85	58.63	58.45	57.82	56.29	56.98	60.51
Sigma	1.26	1.49	1.31	1.19	1.09	1.48	1.26	1.23	1.24	1.19	1.13	1.08	1.11

**Drift Calculation**

HFE3	0 kRad	8.1 kRad	22.5 kRad	53.1 kRad	108.9 kRad	162.9 kRad	204.3 kRad	255.6 kRad	305.1 kRad	351 kRad	396 kRad	24 Hours	168 Hours
OFF TID samples													
33	-	426.0E-06	751.5E-06	932.4E-06	2.0E-03	2.3E-03	2.7E-03	3.3E-03	3.3E-03	3.5E-03	4.0E-03	3.7E-03	2.6E-03
34	-	275.5E-06	639.9E-06	885.6E-06	1.9E-03	2.0E-03	2.4E-03	3.0E-03	3.0E-03	3.2E-03	3.7E-03	3.5E-03	2.4E-03
36	-	345.6E-06	626.4E-06	811.7E-06	1.8E-03	1.8E-03	2.2E-03	2.8E-03	3.0E-03	3.1E-03	3.6E-03	3.4E-03	2.5E-03
Average	-	349.1E-06	672.6E-06	869.9E-06	1.9E-03	2.0E-03	2.4E-03	3.0E-03	3.1E-03	3.3E-03	3.8E-03	3.5E-03	2.5E-03
Sigma	-	61.5E-06	56.0E-06	49.4E-06	76.6E-06	211.9E-06	176.7E-06	221.1E-06	161.0E-06	161.8E-06	147.8E-06	129.2E-06	65.2E-06

Parameter : Gain Bandwidth Product : FT

Test conditions : VCE=5V. IC=0.5A

Unit : Hz

Spec Limit Min : 70.0E+06

Spec limits are represented in bold lines on the graphic.

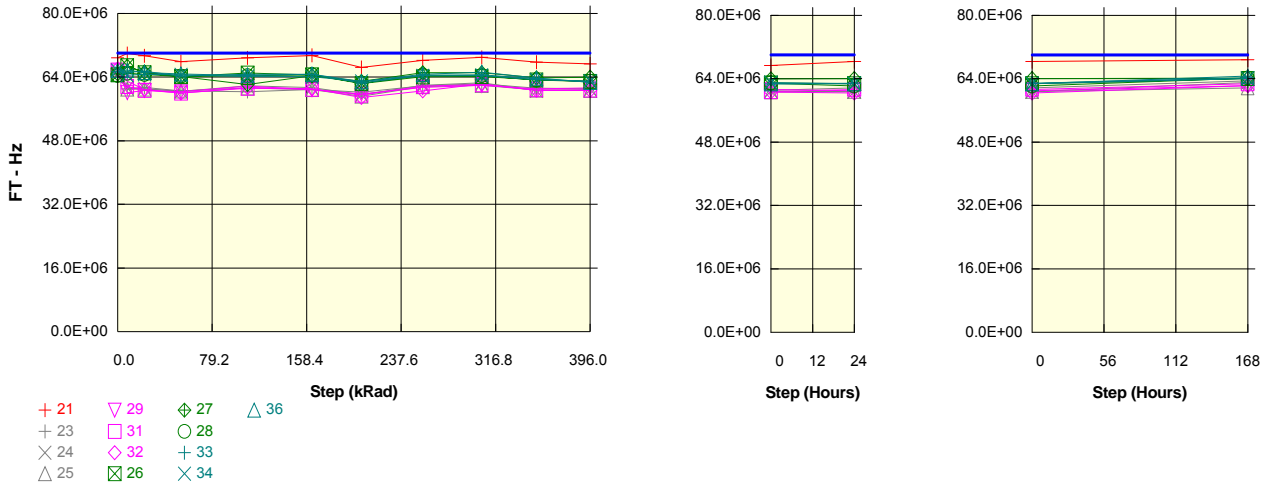

- + 21    ▽ 29    ◆ 27    △ 36
- + 23    □ 31    ○ 28
- × 24    ◇ 32    + 33
- △ 25    ⊠ 26    × 34

Measurements

FT	0 kRad	8.1 kRad	22.5 kRad	53.1 kRad	108.9 kRad	162.9 kRad	204.3 kRad	255.6 kRad	305.1 kRad	351 kRad	396 kRad	24 Hours	168 Hours
21 REF	68.9E+06	69.9E+06	69.4E+06	67.9E+06	68.8E+06	69.4E+06	66.4E+06	68.2E+06	69.0E+06	67.8E+06	67.3E+06	68.4E+06	68.8E+06
ON PROTON samples													
23	65.3E+06	61.0E+06	61.4E+06	60.5E+06	60.4E+06	60.9E+06	60.2E+06	61.8E+06	62.3E+06	61.2E+06	61.1E+06	61.6E+06	63.5E+06
24	64.9E+06	61.3E+06	61.1E+06	60.4E+06	61.8E+06	61.3E+06	59.6E+06	61.9E+06	62.6E+06	60.6E+06	60.9E+06	60.8E+06	63.1E+06
25	64.7E+06	61.0E+06	61.0E+06	60.5E+06	61.3E+06	60.8E+06	59.2E+06	61.6E+06	61.9E+06	60.8E+06	60.7E+06	60.8E+06	61.7E+06
Statistics													
Min	64.7E+06	61.0E+06	61.0E+06	60.4E+06	60.4E+06	60.8E+06	59.2E+06	61.6E+06	61.9E+06	60.6E+06	60.7E+06	60.8E+06	61.7E+06
Max	65.3E+06	61.3E+06	61.4E+06	60.5E+06	61.8E+06	61.3E+06	60.2E+06	61.9E+06	62.6E+06	61.2E+06	61.1E+06	61.6E+06	63.5E+06
Average	65.0E+06	61.1E+06	61.2E+06	60.5E+06	61.1E+06	61.0E+06	59.7E+06	61.8E+06	62.3E+06	60.9E+06	60.9E+06	61.1E+06	62.7E+06
Sigma	249.5E+03	150.3E+03	166.0E+03	60.1E+03	604.0E+03	214.6E+03	416.7E+03	127.3E+03	264.3E+03	273.3E+03	172.7E+03	409.5E+03	759.8E+03

Drift Calculation

FT	0 kRad	8.1 kRad	22.5 kRad	53.1 kRad	108.9 kRad	162.9 kRad	204.3 kRad	255.6 kRad	305.1 kRad	351 kRad	396 kRad	24 Hours	168 Hours
ON PROTON samples													
23	-	-4.3E+06	-3.9E+06	-4.8E+06	-5.0E+06	-4.4E+06	-5.1E+06	-3.5E+06	-3.0E+06	-4.1E+06	-4.2E+06	-3.7E+06	-1.9E+06
24	-	-3.6E+06	-3.8E+06	-4.5E+06	-3.1E+06	-3.6E+06	-5.4E+06	-3.0E+06	-2.4E+06	-4.3E+06	-4.0E+06	-4.2E+06	-1.9E+06
25	-	-3.7E+06	-3.7E+06	-4.2E+06	-3.5E+06	-3.9E+06	-5.5E+06	-3.1E+06	-2.8E+06	-4.0E+06	-4.0E+06	-3.9E+06	-3.0E+06
Average	-	-3.9E+06	-3.8E+06	-4.5E+06	-3.8E+06	-3.9E+06	-5.3E+06	-3.2E+06	-2.7E+06	-4.1E+06	-4.1E+06	-3.9E+06	-2.3E+06
Sigma	-	297.4E+03	84.0E+03	233.3E+03	811.5E+03	333.0E+03	167.3E+03	204.3E+03	281.8E+03	150.3E+03	81.8E+03	199.7E+03	555.8E+03

Measurements

FT	0 kRad	8.1 kRad	22.5 kRad	53.1 kRad	108.9 kRad	162.9 kRad	204.3 kRad	255.6 kRad	305.1 kRad	351 kRad	396 kRad	24 Hours	168 Hours
21 REF	68.9E+06	69.9E+06	69.4E+06	67.9E+06	68.8E+06	69.4E+06	66.4E+06	68.2E+06	69.0E+06	67.8E+06	67.3E+06	68.4E+06	68.8E+06
ON TID samples													
29	65.5E+06	60.1E+06	60.7E+06	60.3E+06	61.7E+06	60.9E+06	59.8E+06	61.4E+06	61.9E+06	61.0E+06	61.3E+06	61.0E+06	62.2E+06
31	65.8E+06	61.6E+06	60.7E+06	60.0E+06	61.2E+06	61.0E+06	59.5E+06	61.7E+06	62.1E+06	60.8E+06	60.8E+06	61.3E+06	62.7E+06
32	66.1E+06	62.9E+06	60.9E+06	60.0E+06	61.4E+06	61.1E+06	58.9E+06	60.6E+06	62.3E+06	60.7E+06	60.7E+06	60.4E+06	62.2E+06
Statistics													
Min	65.5E+06	60.1E+06	60.7E+06	60.0E+06	61.2E+06	60.9E+06	58.9E+06	60.6E+06	61.9E+06	60.7E+06	60.7E+06	60.4E+06	62.2E+06
Max	66.1E+06	62.9E+06	60.9E+06	60.3E+06	61.7E+06	61.1E+06	59.8E+06	61.7E+06	62.3E+06	61.0E+06	61.3E+06	61.3E+06	62.7E+06
Average	65.8E+06	61.6E+06	60.8E+06	60.1E+06	61.4E+06	61.0E+06	59.4E+06	61.2E+06	62.1E+06	60.8E+06	60.9E+06	60.9E+06	62.4E+06
Sigma	254.3E+03	1.2E+06	90.7E+03	150.6E+03	226.0E+03	88.4E+03	369.9E+03	494.0E+03	158.0E+03	132.6E+03	257.2E+03	375.0E+03	237.4E+03

Drift Calculation

FT	0 kRad	8.1 kRad	22.5 kRad	53.1 kRad	108.9 kRad	162.9 kRad	204.3 kRad	255.6 kRad	305.1 kRad	351 kRad	396 kRad	24 Hours	168 Hours
ON TID samples													
29	-	-5.4E+06	-4.8E+06	-5.2E+06	-3.7E+06	-4.6E+06	-5.7E+06	-4.1E+06	-3.6E+06	-4.5E+06	-4.2E+06	-4.5E+06	-3.2E+06
31	-	-4.1E+06	-5.1E+06	-5.8E+06	-4.6E+06	-4.8E+06	-6.3E+06	-4.0E+06	-3.7E+06	-5.0E+06	-5.0E+06	-4.5E+06	-3.0E+06
32	-	-3.2E+06	-5.2E+06	-6.1E+06	-4.8E+06	-5.0E+06	-7.2E+06	-5.6E+06	-3.8E+06	-5.4E+06	-5.4E+06	-5.7E+06	-3.9E+06
Average	-	-4.2E+06	-5.0E+06	-5.7E+06	-4.4E+06	-4.8E+06	-6.4E+06	-4.6E+06	-3.7E+06	-5.0E+06	-4.9E+06	-4.9E+06	-3.4E+06
Sigma	-	911.5E+03	168.3E+03	392.1E+03	434.8E+03	165.8E+03	623.0E+03	706.3E+03	96.3E+03	385.2E+03	497.4E+03	577.1E+03	360.1E+03

Hirex Engineering	Total Dose Radiation Test Report									Ref.:	HRX/TID/1012		
	2N5154					Microsemi				Issue:	01		

**Measurements**

FT	0 kRad	8.1 kRad	22.5 kRad	53.1 kRad	108.9 kRad	162.9 kRad	204.3 kRad	255.6 kRad	305.1 kRad	351 kRad	396 kRad	24 Hours	168 Hours
21_REF	68.9E+06	69.9E+06	69.4E+06	67.9E+06	68.8E+06	69.4E+06	66.4E+06	68.2E+06	69.0E+06	67.8E+06	67.3E+06	68.4E+06	68.8E+06
OFF POTON samples													
26	64.6E+06	66.8E+06	65.1E+06	64.1E+06	65.0E+06	64.6E+06	62.3E+06	64.1E+06	64.1E+06	63.3E+06	62.9E+06	62.7E+06	64.1E+06
27	64.8E+06	66.7E+06	65.3E+06	64.2E+06	62.1E+06	64.3E+06	62.9E+06	65.1E+06	65.1E+06	63.8E+06	64.0E+06	64.1E+06	64.2E+06
28	64.4E+06	65.0E+06	64.6E+06	64.2E+06	64.4E+06	64.6E+06	62.5E+06	64.5E+06	64.4E+06	63.2E+06	62.9E+06	62.2E+06	64.2E+06
Statistics													
Min	64.4E+06	65.0E+06	64.6E+06	64.1E+06	62.1E+06	64.3E+06	62.3E+06	64.1E+06	64.1E+06	63.2E+06	62.9E+06	62.2E+06	64.1E+06
Max	64.8E+06	66.8E+06	65.3E+06	64.2E+06	65.0E+06	64.6E+06	62.9E+06	65.1E+06	65.1E+06	63.8E+06	64.0E+06	64.1E+06	64.2E+06
Average	64.6E+06	66.2E+06	65.0E+06	64.2E+06	63.8E+06	64.5E+06	62.6E+06	64.6E+06	64.5E+06	63.5E+06	63.3E+06	63.0E+06	64.1E+06
Sigma	153.9E+03	849.6E+03	262.5E+03	34.8E+03	1.3E+06	99.4E+03	253.8E+03	415.9E+03	411.6E+03	263.2E+03	500.0E+03	798.0E+03	45.6E+03

**Drift Calculation**

FT	0 kRad	8.1 kRad	22.5 kRad	53.1 kRad	108.9 kRad	162.9 kRad	204.3 kRad	255.6 kRad	305.1 kRad	351 kRad	396 kRad	24 Hours	168 Hours
OFF POTON samples													
26	-	2.3E+06	492.6E+03	-474.1E+03	462.6E+03	-29.8E+03	-2.2E+06	-488.9E+03	-444.6E+03	-1.3E+06	-1.6E+06	-1.8E+06	-503.6E+03
27	-	1.9E+06	449.3E+03	-638.6E+03	-2.7E+06	-479.0E+03	-1.9E+06	284.2E+03	284.2E+03	-992.3E+03	-844.5E+03	-757.4E+03	-653.4E+03
28	-	523.8E+03	193.2E+03	-266.6E+03	-89.0E+03	103.9E+03	-2.0E+06	44.5E+03	-74.2E+03	-1.2E+06	-1.6E+06	-2.3E+06	-266.6E+03
Average	-	1.6E+06	378.4E+03	-459.7E+03	-776.5E+03	-135.0E+03	-2.0E+06	-53.4E+03	-78.2E+03	-1.2E+06	-1.3E+06	-1.6E+06	-474.5E+03
Sigma	-	743.9E+03	132.1E+03	152.2E+03	1.4E+06	249.3E+03	149.8E+03	323.1E+03	297.5E+03	122.2E+03	357.7E+03	644.4E+03	159.3E+03

**Measurements**

FT	0 kRad	8.1 kRad	22.5 kRad	53.1 kRad	108.9 kRad	162.9 kRad	204.3 kRad	255.6 kRad	305.1 kRad	351 kRad	396 kRad	24 Hours	168 Hours
21_REF	68.9E+06	69.9E+06	69.4E+06	67.9E+06	68.8E+06	69.4E+06	66.4E+06	68.2E+06	69.0E+06	67.8E+06	67.3E+06	68.4E+06	68.8E+06
OFF TID samples													
33	65.3E+06	65.2E+06	65.5E+06	64.3E+06	64.7E+06	64.7E+06	62.5E+06	64.4E+06	64.6E+06	63.6E+06	62.7E+06	62.9E+06	64.2E+06
34	65.7E+06	64.5E+06	64.7E+06	64.6E+06	64.1E+06	64.1E+06	62.9E+06	64.3E+06	64.4E+06	63.3E+06	63.0E+06	62.7E+06	64.0E+06
36	65.7E+06	65.7E+06	65.2E+06	64.8E+06	64.4E+06	64.7E+06	62.9E+06	64.7E+06	65.3E+06	63.8E+06	62.7E+06	62.7E+06	64.7E+06
Statistics													
Min	65.3E+06	64.5E+06	64.7E+06	64.3E+06	64.1E+06	64.1E+06	62.5E+06	64.3E+06	64.4E+06	63.3E+06	62.7E+06	62.7E+06	64.0E+06
Max	65.7E+06	65.7E+06	65.5E+06	64.8E+06	64.7E+06	64.7E+06	62.9E+06	64.7E+06	65.3E+06	63.8E+06	63.0E+06	62.9E+06	64.7E+06
Average	65.6E+06	65.1E+06	65.1E+06	64.5E+06	64.4E+06	64.5E+06	62.8E+06	64.5E+06	64.8E+06	63.5E+06	62.8E+06	62.8E+06	64.3E+06
Sigma	172.5E+03	517.7E+03	300.9E+03	224.5E+03	236.2E+03	309.5E+03	181.2E+03	161.6E+03	364.3E+03	191.6E+03	136.0E+03	54.0E+03	260.2E+03

**Drift Calculation**

FT	0 kRad	8.1 kRad	22.5 kRad	53.1 kRad	108.9 kRad	162.9 kRad	204.3 kRad	255.6 kRad	305.1 kRad	351 kRad	396 kRad	24 Hours	168 Hours
OFF TID samples													
33	-	-132.7E+03	135.5E+03	-1.1E+06	-628.9E+03	-630.0E+03	-2.8E+06	-896.5E+03	-762.9E+03	-1.8E+06	-2.6E+06	-2.5E+06	-1.1E+06
34	-	-1.2E+06	-930.9E+03	-1.1E+06	-1.5E+06	-1.6E+06	-2.8E+06	-1.3E+06	-1.2E+06	-2.4E+06	-2.7E+06	-2.9E+06	-1.6E+06
36	-	-14.1E+03	-572.7E+03	-916.9E+03	-1.3E+06	-1.0E+06	-2.9E+06	-1.0E+06	-467.6E+03	-2.0E+06	-3.1E+06	-3.0E+06	-1.1E+06
Average	-	-453.7E+03	-456.0E+03	-1.0E+06	-1.2E+06	-1.1E+06	-2.8E+06	-1.1E+06	-824.5E+03	-2.0E+06	-2.8E+06	-2.8E+06	-1.3E+06
Sigma	-	540.0E+03	443.1E+03	88.4E+03	385.8E+03	403.7E+03	43.5E+03	189.9E+03	319.7E+03	248.3E+03	193.5E+03	226.4E+03	256.3E+03

## **Appendix 1: Temperature measurements on TID samples**

Hirex Engineering	Total Dose Radiation Test Report		Ref.:	HRX/TID/1012
	2N5154	Microsemi	Issue:	01

Initial Measurements

SN	Temp [°C]	ICEO [A]
spec min	110	
spec max	110	
29	110	27.9E-9
31	110	3.4E-6
32	110	4.9E-6
33	110	1.6E-6
34	110	1.8E-6
36	110	1.0E-6

min	1.1E-9
max	4.9E-6
Average	1.8E-6

Final Measurements

SN	Temp [°C]	ICEO [A]
spec min	110	
spec max	110	
29	110	487.6E-9
31	110	559.0E-9
32	110	472.0E-9
33	110	1.4E-6
34	110	1.6E-6
36	110	1.5E-6

min	412.9E-9
max	2.7E-6
Average	1.3E-6