

# TOTAL DOSE RADIATION TEST REPORT

ESA study: "Survey of Critical Components for 150 kRad Power Systems"

ESTEC Contract N° 22831/09/NL/AF refers



Contract extension up to 400 kRad as per CCN: ATGSP-CN-0004 IS. 3

## Final Report

<b>Part Type : HS-4424BRH</b>
<b>Package : FP-16</b>
<b>Description : Dual, Non Inverting Power Mosfet Driver</b>
<b>Manufacturer : Intersil</b>

Alter Technology Purchase Order N° ATGSP-TL-09-JC-CO-9 dated 11/27/2009

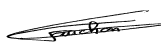
Alter Technology Project Manager Responsible: David NUNEZ

<b>Hirex reference :</b>	HRX/TID/1013	Issue : 01	Date :	January 24 <sup>th</sup> , 2012
<b>Written by :</b>	G. FAUCHON	Test Lab Operations Team Leader		
<b>Approved by :</b>	O.PERROTIN	Test Lab Operations Manager		
<b>Authorized by:</b>	J.F. PASCAL	Technical Director		

Hirex Engineering	Total Dose Radiation Test Report		Ref.:	HRX/TID/1013
	HS-4424BRH	Intersil	Issue:	01

**CHANGE RECORD**

ISSUE	DATE	PAGE	DESCRIPTION OF CHANGES
01	January 24th, 2012	All	Original Issue

Hirex Engineering	Total Dose Radiation Test Report		Ref.:	HRX/TID/1013
	HS-4424BRH	Intersil	Issue:	01

**TOTAL DOSE RADIATION TEST REPORT**  
**on**  
**Intersil**  
**HS-4424BRH**  
**Dual, Non Inverting Power Mosfet Driver**

**TABLE OF CONTENTS**

**1 INTRODUCTION.....4**

**2 APPLICABLE AND REFERENCE DOCUMENTS .....4**

2.1 APPLICABLE DOCUMENTS .....4

2.2 REFERENCE DOCUMENTS .....4

**3 TEST SAMPLES .....4**

**4 EXPERIMENTAL CONDITIONS.....6**

4.1 RADIATION SOURCE DOSE RATE AND ANNEALING.....6

4.2 BIAS DURING DOSE EXPOSURES AND MEASUREMENTS CONDITIONS.....6

4.2.1 Bias conditions .....6

4.2.2 Electrical Measurements.....7

**5 CONCLUSION.....9**

**6 TEST RESULTS.....10**

**LIST OF FIGURES:**

Figure 1 : Samples bias flow diagram.....4

Figure 2 : Bias Conditions during Irradiation Exposures .....6

Figure 3 : HS-4424BRH test program principle .....7

**LIST OF TABLES:**

Table 1 : Measured electrical parameters .....8

Table 2 : Summary of parameters failure levels .....9

Hirex Engineering	Total Dose Radiation Test Report		Ref.:	HRX/TID/1013
	HS-4424BRH	Intersil	Issue:	01

## 1 Introduction

In the scope of the ESA study: "Survey of Critical Components for 150 kRad Power Systems", a total dose radiation verification test of the Intersil HS-4424BRH, Dual, Non Inverting Power Mosfet Driver has been performed with an accumulated dose of about 416 Krad(Si) at different dose rates of 36, 100 & 300 rad(Si)/hour, in response to Alter Technology purchase order reference ATGSP-TL-09-JC-CO-9.

An Interim report, HRX/TID/0928 Issue 01, corresponding to the irradiation up to 156 Krad(Si) has been already provided.

The purpose of this test was to evaluate total dose withstanding of this component, to investigate its suitability for being used in space applications. This test was conducted on samples provided by Alter Technology.

Test has been performed in accordance with Hirex Engineering Radiation Test Plan HRX/SPE/0233 issue 2 dated 09/08/2010.

A complete set of electrical measurements together with graphical representation of measured parameters with respect to total dose received, are provided for all samples.

## 2 Applicable and Reference Documents

### 2.1 Applicable Documents

- Hirex Engineering Radiation Test Plan: HRX/SPE/0233 issue 2 dated 09/08/2010
- Alter Technology Proposal: ATGSP-OF-648/2009 Issue 1
- Minutes of Meeting: MM-SRP-ATG-0001 dated 29/10/2009
- Hirex internal specification: Total Ionizing dose test general procedure.
- SMD detail specification: 5962-99560

### 2.2 Reference Documents

- Intersil datasheet: 4739.1, June 1999

## 3 Test Samples

13 samples of the HS-4424BRH device were tested (6 ON + 6 OFF + 1 control sample).

12 samples (including the 6 samples already submitted to protons test: see report HRX/TID/0878) will be biased according to the flow diagram given in Figure 1.

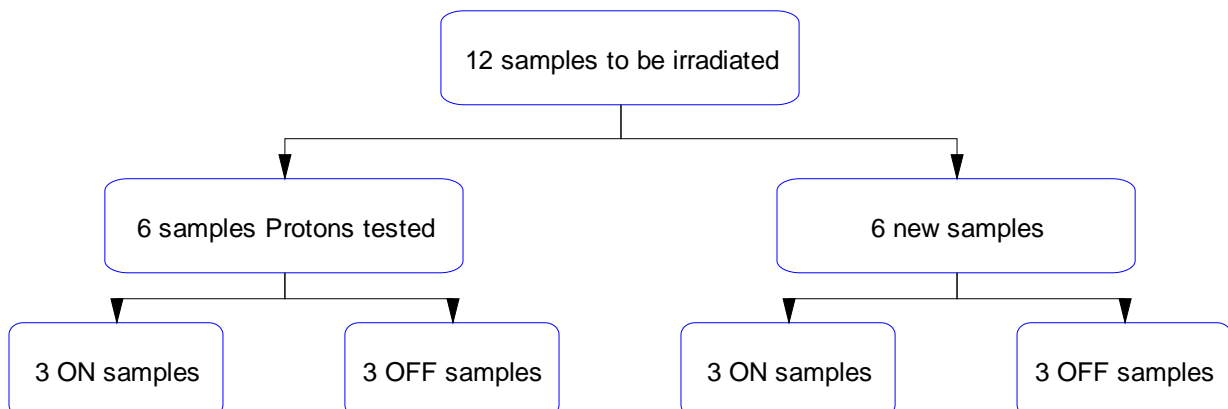

Figure 1 : Samples bias flow diagram

Hirex Engineering	Total Dose Radiation Test Report		Ref.:	HRX/TID/1013
	HS-4424BRH	Intersil	Issue:	01

Samples were allocated into the bias conditions during exposures and annealing as provided in the following table. The different samples groups are also identified for an easier plots reading.

Number serialized by Hirex	Samples Allocation	Samples Group Naming
1	Control sample	REF
2	Biased ON	ON_PROTON
4	Biased ON	ON_PROTON
5	Biased ON	ON_PROTON
6	Biased OFF	OFF_PROTON
7	Biased OFF	OFF_PROTON
14	Biased OFF	OFF_PROTON
8	Biased OFF	OFF_TID
9	Biased OFF	OFF_TID
10	Biased OFF	OFF_TID
11	Biased ON	ON_TID
12	Biased ON	ON_TID
13	Biased ON	ON_TID

Identification of the HS-4424BRH is given below:

**Part Number:** HS9-4424BRH/PROTO

**Top Marking:** logo HS9-4424BRH delta/PROTO

**Bottom Marking:** -

**Date Code:** -

## 4 Experimental Conditions

### 4.1 Radiation Source Dose Rate and Annealing

The dose exposures were performed at UCL in Louvain (Belgium). In this irradiation facility, a Cobalt 60 source is used with the possibility to vary the dose rate by simply adjusting the distance to the source. During the dose exposures, devices under test have been irradiated in an ambient temperature of 24°C ±6°C.

The dose received by the devices has been controlled by the measurement of one Alanine pellet dosimeter placed onto the bias board.

Resulting test conditions are provided below.

Irradiation Steps requested	Pellet dosimetry data	Dose rate	Annealing steps	Temperature
kRad	kRad	Rad/h	Hours	°C
0	0			
10	10.8	36		Room
20	20.7	36		Room
50	55.6	36		Room
100	102.6	36		Room
150	155.7	100 [1]		Room
200	212.4	300 [1]		Room
250	268.2	300 [1]		Room
300	326.7	300 [1]		Room
350	374.2	300 [1]		Room
400	416.7	300 [1]		Room
			24	Room
			168	100

Note [1]: Due to the maintenance period planned at UCL at the end of December and in order to perform subsequent requested exposures steps up to 400 Krad(Si), the dose rate of the last step has been changed, in agreement with ESA, from 36 rad(Si)/h to 100 rad(Si)/h and from 100 rad(Si)/h to 300 rad(Si)/h as indicated.

### 4.2 Bias during Dose Exposures and Measurements conditions

#### 4.2.1 Bias conditions

During exposures test board allowed to bias 6 samples in accordance with the electrical circuit provided in Figure 2. 6 other samples were biased OFF with all pins connected to ground.

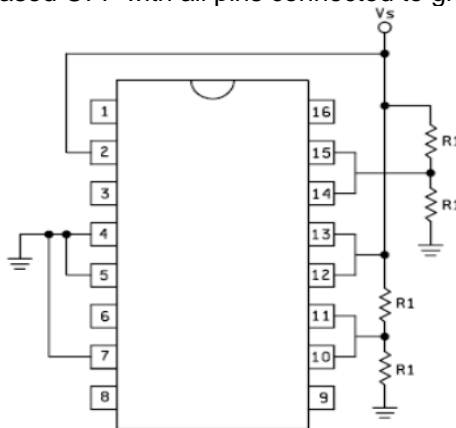

NOTES:  $V_s = 15\text{ V}$  and  $R_1 = 5\text{ k}\Omega$ .

Figure 2 : Bias Conditions during Irradiation Exposures

Hirex Engineering	Total Dose Radiation Test Report		Ref.:	HRX/TID/1013
	HS-4424BRH	Intersil	Issue:	01

4.2.2 Electrical Measurements

Electrical parameters test program principle for HS-4424BRH is provided in Figure 3.

A HP4142 DC tester and a HP33120 waveform generator were used to perform required measurements.

A dedicated test fixture was designed to ensure proper measurement conditions. In addition a faraday cage was used to ensure optimum conditions for low level measurements.

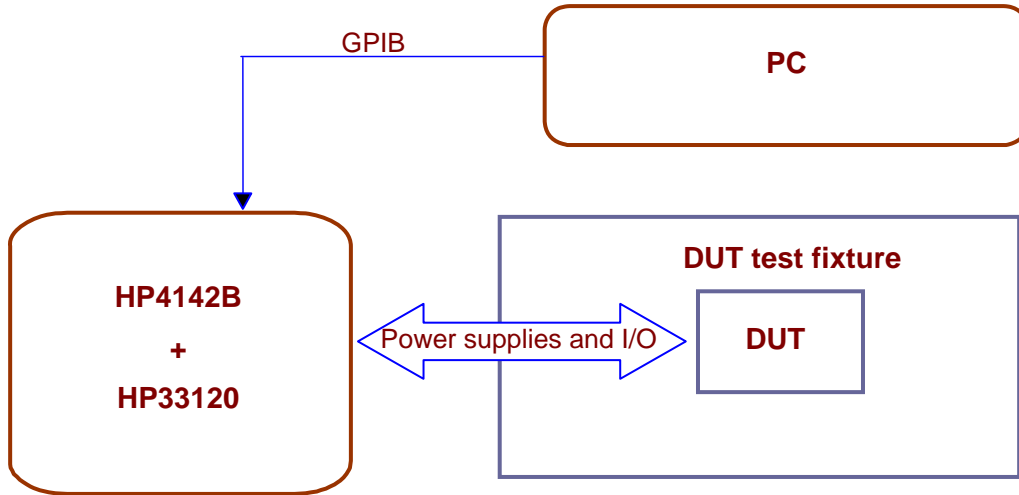

Figure 3 : HS-4424BRH test program principle

Hirex Engineering	Total Dose Radiation Test Report		Ref.:	HRX/TID/1013
	HS-4424BRH	Intersil	Issue:	01

Electrical parameters test conditions and limits used for performing this test are given in Table 1.

Parameter	Description	Conditions	Spec		Unit
			Min	Max	
<a href="#">ICCSBL</a>	Power supply current, low	VS = 18V ; VIN = 0V	-	3.5	mA
<a href="#">ICCSBH</a>	Power supply current, high	VS = 18V ; VIN = 18V	-	3.5	mA
<a href="#">IIL_A</a>	Input current, low	VS = 18V	-2	2	μA
<a href="#">IIL_B</a>	Input current, low	VS = 18V	-2	2	μA
<a href="#">IIH_A</a>	Input current, high	VS = 18V	-2	2	μA
<a href="#">IIH_B</a>	Input current, high	VS = 18V	-2	2	μA
<a href="#">VOL_A</a>	Voltage output	VS = 12V	-	0.8	V
<a href="#">VOL_B</a>	Voltage output	VS = 12V	-	0.8	V
<a href="#">VOH_A</a>	Voltage output	VS = 12V	11.25	-	V
<a href="#">VOH_B</a>	Voltage output	VS = 12V	11.25	-	V
<a href="#">TPHL_A</a>	Propagation delay, low	VS = 12V ; CL = 4300 pF	-	250	ns
<a href="#">TPHL_B</a>	Propagation delay, low	VS = 12V ; CL = 4300 pF	-	250	ns
<a href="#">TPLH_A</a>	Propagation delay, high	VS = 12V ; CL = 4300 pF	-	250	ns
<a href="#">TPLH_B</a>	Propagation delay, high	VS = 12V ; CL = 4300 pF	-	250	ns
<a href="#">TR_A</a>	Response time, rise	VS = 12V ; CL = 4300 pF	-	75	ns
<a href="#">TR_B</a>	Response time, rise	VS = 12V ; CL = 4300 pF	-	75	ns
<a href="#">TF_A</a>	Response time, fall	VS = 12V ; CL = 4300 pF	-	75	ns
<a href="#">TF_B</a>	Response time, fall	VS = 12V ; CL = 4300 pF	-	75	ns

**Table 1 : Measured electrical parameters**



Hirex Engineering	Total Dose Radiation Test Report		Ref.:	HRX/TID/1013
	HS-4424BRH	Intersil	Issue:	01

## 5 Conclusion

A Total Ionizing Dose verification test was carried out by Hirex Engineering under Alter Technology contract on the Intersil HS-4424BRH Dual, Non Inverting Power Mosfet Driver in FP-16 package.

12 samples plus one control sample were used during testing. They were exposed to radiation using different dose rates of 36, 100 & 300 rad(Si)/hour at room temperature.

A summary of failed parameters is provided in the following table. The behavior of each parameter is recorded for both biased On and biased Off samples of each group.

Parameters not listed remained within specification limits all along testing.

Detail test results are presented in next section.

Parameters	Failure Level between :		Annealing Recovery [Note 1]					Comments
			NA	No	Partial	Complete	Rebound	
<a href="#">IIL_A</a>	ON_PROTON samples	0 & 10.8 kRad(Si)		X				
	ON_TID samples	10.8 & 20.7 kRad(Si)		X				
	OFF_PROTON samples	0 & 10.8 kRad(Si)		X				
	OFF_TID samples	10.8 & 20.7 kRad(Si)		X				
<a href="#">IIL_B</a>	ON_PROTON samples	20.7 & 55.6 kRad(Si)				X		
	ON_TID samples	20.7 & 55.6 kRad(Si)				X		
	OFF_PROTON samples	10.8 & 20.7 kRad(Si)		X				
	OFF_TID samples	10.8 & 20.7 kRad(Si)		X				

[Note 1]: **NA** = Not applicable, **No**: means no sample has recovered, **Partial**: means at least one sample has recovered, **Complete**: means all samples have recovered, **Rebound**: means rebound has been observed on at least one sample.

**Table 2 : Summary of parameters failure levels**

Hirex Engineering	Total Dose Radiation Test Report		Ref.:	HRX/TID/1013
	HS-4424BRH	Intersil	Issue:	01

## 6 Test Results

Test results including tables and graphics are provided in this section for each measured parameter.

Statistics are provided separately for biased ON & biased OFF samples of each group.

For each parameter, a drift calculation table is provided computing the drift between a given exposure step with respect to initial readings:

$$\Delta(\text{Parameter value}) = (\text{Parameter value}_{\text{POSTRAD}}) - (\text{Parameter value}_{\text{PRERAD}})$$

Hirex Engineering	Total Dose Radiation Test Report			Ref.:	HRX/TID/1013
	HS-4424BRH	Intersil		Issue:	01

Parameter : Power Supply Current. Low : ICCSBL

Test conditions : VS=18V. VIN=0V

Unit : A

Spec Limit Max : 3.5E-03

Spec limits are represented in bold lines on the graphic.

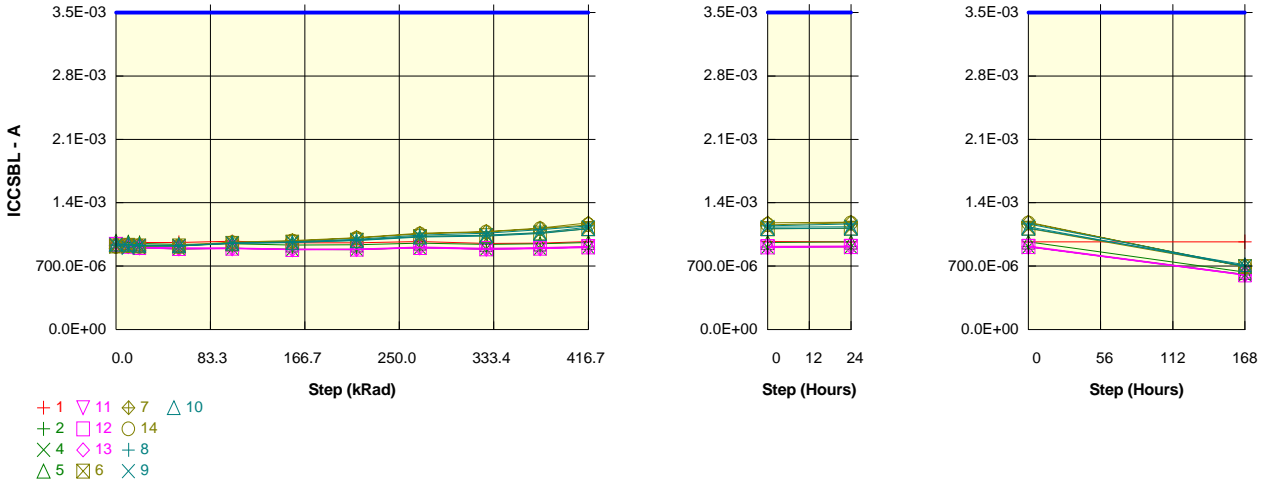

Measurements

ICCSBL	0 kRad	10.8 kRad	20.7 kRad	55.6 kRad	102.6 kRad	155.7 kRad	212.4 kRad	268.2 kRad	326.7 kRad	374.2 kRad	416.7 kRad	24 Hours	168 Hours
1 REF	953.5E-06	965.8E-06	961.8E-06	960.3E-06	972.9E-06	956.4E-06	956.4E-06	970.1E-06	951.3E-06	952.4E-06	970.8E-06	965.8E-06	968.2E-06
ON_PROTON samples													
2	923.7E-06	913.7E-06	902.2E-06	891.8E-06	895.1E-06	884.5E-06	883.8E-06	902.1E-06	889.0E-06	895.7E-06	910.4E-06	913.5E-06	605.5E-06
4	917.5E-06	913.7E-06	902.3E-06	889.9E-06	895.2E-06	885.0E-06	884.4E-06	902.6E-06	889.2E-06	895.1E-06	909.2E-06	913.2E-06	608.0E-06
5	971.8E-06	961.3E-06	951.3E-06	938.6E-06	944.4E-06	933.5E-06	934.8E-06	954.2E-06	940.2E-06	946.0E-06	961.0E-06	965.9E-06	632.8E-06
Statistics													
Min	917.5E-06	913.7E-06	902.2E-06	889.9E-06	895.1E-06	884.5E-06	883.8E-06	902.1E-06	889.0E-06	895.1E-06	909.2E-06	913.2E-06	605.5E-06
Max	971.8E-06	961.3E-06	951.3E-06	938.6E-06	944.4E-06	933.5E-06	934.8E-06	954.2E-06	940.2E-06	946.0E-06	961.0E-06	965.9E-06	632.8E-06
Average	937.6E-06	929.6E-06	918.6E-06	906.8E-06	911.6E-06	901.0E-06	901.0E-06	919.6E-06	906.1E-06	912.3E-06	926.8E-06	930.9E-06	615.4E-06
Sigma	24.3E-06	22.5E-06	23.2E-06	22.5E-06	23.2E-06	23.0E-06	23.9E-06	24.5E-06	24.1E-06	23.8E-06	24.1E-06	24.8E-06	12.3E-06

Drift Calculation

ICCSBL	0 kRad	10.8 kRad	20.7 kRad	55.6 kRad	102.6 kRad	155.7 kRad	212.4 kRad	268.2 kRad	326.7 kRad	374.2 kRad	416.7 kRad	24 Hours	168 Hours
ON_PROTON samples													
2	-	-10.0E-06	-21.5E-06	-31.9E-06	-28.5E-06	-39.2E-06	-39.9E-06	-21.6E-06	-34.6E-06	-28.0E-06	-13.3E-06	-10.1E-06	-318.1E-06
4	-	-3.9E-06	-15.3E-06	-27.6E-06	-22.3E-06	-32.5E-06	-33.1E-06	-14.9E-06	-28.3E-06	-22.4E-06	-8.3E-06	-4.3E-06	-309.6E-06
5	-	-10.4E-06	-20.4E-06	-33.1E-06	-27.4E-06	-38.3E-06	-37.0E-06	-17.5E-06	-31.6E-06	-25.8E-06	-10.8E-06	-5.8E-06	-339.0E-06
Average	-	-8.1E-06	-19.1E-06	-30.9E-06	-26.1E-06	-36.7E-06	-36.6E-06	-18.0E-06	-31.5E-06	-25.4E-06	-10.8E-06	-6.8E-06	-322.2E-06
Sigma	-	3.0E-06	2.7E-06	2.3E-06	2.7E-06	2.9E-06	2.8E-06	2.7E-06	2.6E-06	2.3E-06	2.0E-06	2.5E-06	12.4E-06

Measurements

ICCSBL	0 kRad	10.8 kRad	20.7 kRad	55.6 kRad	102.6 kRad	155.7 kRad	212.4 kRad	268.2 kRad	326.7 kRad	374.2 kRad	416.7 kRad	24 Hours	168 Hours
1 REF	953.5E-06	965.8E-06	961.8E-06	960.3E-06	972.9E-06	956.4E-06	956.4E-06	970.1E-06	951.3E-06	952.4E-06	970.8E-06	965.8E-06	968.2E-06
ON_TID samples													
11	942.3E-06	923.1E-06	909.5E-06	898.6E-06	900.5E-06	889.5E-06	890.9E-06	908.9E-06	896.0E-06	902.9E-06	916.3E-06	920.8E-06	606.7E-06
12	938.2E-06	920.2E-06	906.4E-06	895.9E-06	897.3E-06	883.4E-06	886.7E-06	904.7E-06	890.9E-06	896.8E-06	911.7E-06	915.2E-06	602.2E-06
13	929.5E-06	914.4E-06	900.6E-06	890.6E-06	892.7E-06	881.9E-06	882.7E-06	900.3E-06	886.5E-06	892.4E-06	904.3E-06	910.1E-06	601.7E-06
Statistics													
Min	929.5E-06	914.4E-06	900.6E-06	890.6E-06	892.7E-06	881.9E-06	882.7E-06	900.3E-06	886.5E-06	892.4E-06	904.3E-06	910.1E-06	601.7E-06
Max	942.3E-06	923.1E-06	909.5E-06	898.6E-06	900.5E-06	889.5E-06	890.9E-06	908.9E-06	896.0E-06	902.9E-06	916.3E-06	920.8E-06	606.7E-06
Average	936.7E-06	919.2E-06	905.5E-06	895.1E-06	896.8E-06	885.0E-06	886.8E-06	904.6E-06	891.1E-06	897.4E-06	910.8E-06	915.4E-06	603.5E-06
Sigma	5.4E-06	3.6E-06	3.7E-06	3.3E-06	3.2E-06	3.3E-06	3.3E-06	3.5E-06	3.9E-06	4.3E-06	4.9E-06	4.4E-06	2.3E-06

Drift Calculation

ICCSBL	0 kRad	10.8 kRad	20.7 kRad	55.6 kRad	102.6 kRad	155.7 kRad	212.4 kRad	268.2 kRad	326.7 kRad	374.2 kRad	416.7 kRad	24 Hours	168 Hours
ON_TID samples													
11	-	-19.2E-06	-32.9E-06	-43.7E-06	-41.8E-06	-52.8E-06	-51.4E-06	-33.4E-06	-46.4E-06	-39.4E-06	-26.0E-06	-21.5E-06	-335.6E-06
12	-	-18.1E-06	-31.8E-06	-42.3E-06	-40.9E-06	-54.8E-06	-51.6E-06	-33.6E-06	-47.3E-06	-41.4E-06	-26.5E-06	-23.1E-06	-336.1E-06
13	-	-15.0E-06	-28.8E-06	-38.9E-06	-36.8E-06	-47.5E-06	-46.7E-06	-29.1E-06	-43.0E-06	-37.0E-06	-25.2E-06	-19.3E-06	-327.7E-06
Average	-	-17.4E-06	-31.2E-06	-41.6E-06	-39.8E-06	-51.7E-06	-49.9E-06	-32.0E-06	-45.6E-06	-39.3E-06	-25.9E-06	-21.3E-06	-333.1E-06
Sigma	-	1.8E-06	1.7E-06	2.0E-06	2.2E-06	3.1E-06	2.2E-06	2.1E-06	1.9E-06	1.8E-06	547.1E-09	1.5E-06	3.8E-06

Hirex Engineering	Total Dose Radiation Test Report									Ref.:	HRX/TID/1013	
	HS-4424BRH				Intersil					Issue:	01	

**Measurements**

ICCSBL	0 kRad	10.8 kRad	20.7 kRad	55.6 kRad	102.6 kRad	155.7 kRad	212.4 kRad	268.2 kRad	326.7 kRad	374.2 kRad	416.7 kRad	24 Hours	168 Hours
1_REF	953.5E-06	965.8E-06	961.8E-06	960.3E-06	972.9E-06	956.4E-06	956.4E-06	970.1E-06	951.3E-06	952.4E-06	970.8E-06	965.8E-06	968.2E-06
OFF PROTON samples													
6	922.6E-06	930.9E-06	921.6E-06	924.0E-06	952.6E-06	966.5E-06	988.2E-06	1.0E-03	1.0E-03	1.1E-03	1.1E-03	1.1E-03	696.1E-06
7	929.0E-06	937.4E-06	927.5E-06	927.4E-06	962.5E-06	981.4E-06	1.0E-03	1.1E-03	1.1E-03	1.1E-03	1.2E-03	1.2E-03	689.1E-06
14	920.6E-06	931.8E-06	922.7E-06	920.9E-06	958.2E-06	974.8E-06	1.0E-03	1.1E-03	1.1E-03	1.1E-03	1.2E-03	1.2E-03	696.1E-06
Statistics													
Min	920.6E-06	930.9E-06	921.6E-06	920.9E-06	952.6E-06	966.5E-06	988.2E-06	1.0E-03	1.0E-03	1.1E-03	1.1E-03	1.1E-03	689.1E-06
Max	929.0E-06	937.4E-06	927.5E-06	927.4E-06	962.5E-06	981.4E-06	1.0E-03	1.1E-03	1.1E-03	1.1E-03	1.2E-03	1.2E-03	696.1E-06
Average	924.1E-06	933.3E-06	923.9E-06	924.1E-06	957.8E-06	974.3E-06	1.0E-03	1.0E-03	1.1E-03	1.1E-03	1.1E-03	1.2E-03	693.8E-06
Sigma	3.6E-06	2.9E-06	2.5E-06	2.7E-06	4.0E-06	6.1E-06	11.1E-06	15.6E-06	19.8E-06	23.6E-06	26.6E-06	29.7E-06	3.3E-06

**Drift Calculation**

ICCSBL	0 kRad	10.8 kRad	20.7 kRad	55.6 kRad	102.6 kRad	155.7 kRad	212.4 kRad	268.2 kRad	326.7 kRad	374.2 kRad	416.7 kRad	24 Hours	168 Hours
OFF PROTON samples													
6	-	8.2E-06	-1.1E-06	1.3E-06	30.0E-06	43.9E-06	65.6E-06	103.8E-06	115.4E-06	143.4E-06	190.8E-06	195.0E-06	-226.5E-06
7	-	8.3E-06	-1.6E-06	-1.6E-06	33.4E-06	52.4E-06	85.2E-06	133.0E-06	153.6E-06	189.8E-06	248.2E-06	254.4E-06	-239.9E-06
14	-	11.1E-06	2.1E-06	240.0E-09	37.6E-06	54.2E-06	87.8E-06	135.4E-06	156.0E-06	192.2E-06	236.2E-06	256.6E-06	-224.6E-06
Average	-	9.2E-06	-180.0E-09	-13.3E-09	33.7E-06	50.2E-06	79.5E-06	124.0E-06	141.6E-06	175.1E-06	225.0E-06	235.3E-06	-230.3E-06
Sigma	-	1.3E-06	1.6E-06	1.2E-06	3.1E-06	4.5E-06	9.9E-06	14.4E-06	18.6E-06	22.5E-06	24.7E-06	28.5E-06	6.8E-06

**Measurements**

ICCSBL	0 kRad	10.8 kRad	20.7 kRad	55.6 kRad	102.6 kRad	155.7 kRad	212.4 kRad	268.2 kRad	326.7 kRad	374.2 kRad	416.7 kRad	24 Hours	168 Hours
1_REF	953.5E-06	965.8E-06	961.8E-06	960.3E-06	972.9E-06	956.4E-06	956.4E-06	970.1E-06	951.3E-06	952.4E-06	970.8E-06	965.8E-06	968.2E-06
OFF TID samples													
8	933.6E-06	935.1E-06	924.4E-06	922.9E-06	952.7E-06	966.9E-06	997.4E-06	1.0E-03	1.1E-03	1.1E-03	1.1E-03	1.2E-03	699.5E-06
9	936.5E-06	902.9E-06	923.3E-06	920.0E-06	950.4E-06	960.2E-06	986.3E-06	1.0E-03	1.0E-03	1.1E-03	1.1E-03	1.1E-03	696.0E-06
10	944.8E-06	944.0E-06	933.3E-06	928.9E-06	953.9E-06	959.1E-06	980.9E-06	1.0E-03	1.0E-03	1.1E-03	1.1E-03	1.1E-03	715.2E-06
Statistics													
Min	933.6E-06	902.9E-06	923.3E-06	920.0E-06	950.4E-06	959.1E-06	980.9E-06	1.0E-03	1.0E-03	1.1E-03	1.1E-03	1.1E-03	696.0E-06
Max	944.8E-06	944.0E-06	933.3E-06	928.9E-06	953.9E-06	966.9E-06	997.4E-06	1.0E-03	1.1E-03	1.1E-03	1.1E-03	1.2E-03	715.2E-06
Average	938.3E-06	927.3E-06	927.0E-06	923.9E-06	952.3E-06	962.1E-06	988.2E-06	1.0E-03	1.0E-03	1.1E-03	1.1E-03	1.1E-03	703.6E-06
Sigma	4.7E-06	17.7E-06	4.5E-06	3.7E-06	1.5E-06	3.5E-06	6.9E-06	10.0E-06	14.1E-06	17.7E-06	12.5E-06	19.8E-06	8.3E-06

**Drift Calculation**

ICCSBL	0 kRad	10.8 kRad	20.7 kRad	55.6 kRad	102.6 kRad	155.7 kRad	212.4 kRad	268.2 kRad	326.7 kRad	374.2 kRad	416.7 kRad	24 Hours	168 Hours
OFF TID samples													
8	-	1.5E-06	-9.2E-06	-10.7E-06	19.1E-06	33.3E-06	63.8E-06	110.0E-06	131.4E-06	169.2E-06	211.6E-06	233.6E-06	-234.1E-06
9	-	-33.6E-06	-13.2E-06	-16.5E-06	13.9E-06	23.7E-06	49.8E-06	91.3E-06	105.9E-06	134.3E-06	193.3E-06	197.9E-06	-240.5E-06
10	-	-780.0E-09	-11.5E-06	-15.9E-06	9.1E-06	14.3E-06	36.1E-06	74.6E-06	86.4E-06	116.8E-06	169.8E-06	175.2E-06	-229.6E-06
Average	-	-11.0E-06	-11.3E-06	-14.4E-06	14.0E-06	23.8E-06	49.9E-06	92.0E-06	107.9E-06	140.1E-06	191.6E-06	202.2E-06	-234.7E-06
Sigma	-	16.0E-06	1.6E-06	2.6E-06	4.1E-06	7.8E-06	11.3E-06	14.5E-06	18.4E-06	21.8E-06	17.1E-06	24.0E-06	4.4E-06

Parameter : Power Supply Current. High : ICCSBH  
 Test conditions : VS=18V. VIN=18V  
 Unit : A  
 Spec Limit Max : 3.5E-03  
 Spec limits are represented in bold lines on the graphic.

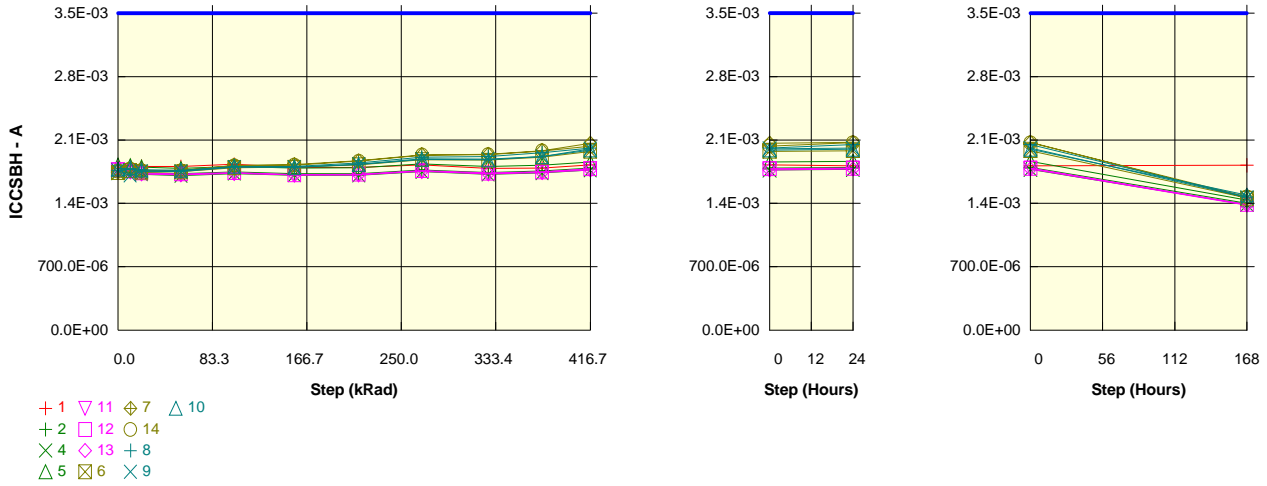

Measurements

ICCSBH	0 kRad	10.8 kRad	20.7 kRad	55.6 kRad	102.6 kRad	155.7 kRad	212.4 kRad	268.2 kRad	326.7 kRad	374.2 kRad	416.7 kRad	24 Hours	168 Hours
1_REF	1.8E-03	1.8E-03	1.8E-03	1.8E-03	1.8E-03	1.8E-03	1.8E-03	1.8E-03	1.8E-03	1.8E-03	1.8E-03	1.8E-03	1.8E-03
ON_PROTON samples													
2	1.8E-03	1.8E-03	1.7E-03	1.7E-03	1.7E-03	1.7E-03	1.7E-03	1.8E-03	1.7E-03	1.8E-03	1.8E-03	1.8E-03	1.4E-03
4	1.7E-03	1.7E-03	1.7E-03	1.7E-03	1.7E-03	1.7E-03	1.7E-03	1.7E-03	1.7E-03	1.7E-03	1.8E-03	1.8E-03	1.4E-03
5	1.8E-03	1.8E-03	1.8E-03	1.8E-03	1.8E-03	1.8E-03	1.8E-03	1.8E-03	1.8E-03	1.8E-03	1.9E-03	1.9E-03	1.4E-03
Statistics													
Min	1.7E-03	1.7E-03	1.7E-03	1.7E-03	1.7E-03	1.7E-03	1.7E-03	1.7E-03	1.7E-03	1.7E-03	1.8E-03	1.8E-03	1.4E-03
Max	1.8E-03	1.8E-03	1.8E-03	1.8E-03	1.8E-03	1.8E-03	1.8E-03	1.8E-03	1.8E-03	1.8E-03	1.9E-03	1.9E-03	1.4E-03
Average	1.8E-03	1.8E-03	1.8E-03	1.7E-03	1.8E-03	1.7E-03	1.7E-03	1.8E-03	1.8E-03	1.8E-03	1.8E-03	1.8E-03	1.4E-03
Sigma	37.0E-06	32.3E-06	33.5E-06	32.6E-06	33.8E-06	33.5E-06	35.2E-06	36.6E-06	36.5E-06	36.6E-06	37.3E-06	38.4E-06	21.6E-06

Drift Calculation

ICCSBH	0 kRad	10.8 kRad	20.7 kRad	55.6 kRad	102.6 kRad	155.7 kRad	212.4 kRad	268.2 kRad	326.7 kRad	374.2 kRad	416.7 kRad	24 Hours	168 Hours
ON_PROTON samples													
2	-	-3.4E-06	-22.8E-06	-33.6E-06	-14.8E-06	-32.0E-06	-34.0E-06	5.6E-06	-21.8E-06	-7.0E-06	27.8E-06	33.0E-06	-361.2E-06
4	-	8.2E-06	-11.0E-06	-26.4E-06	-4.6E-06	-21.6E-06	-23.4E-06	15.4E-06	-12.2E-06	1.0E-06	34.0E-06	40.8E-06	-346.8E-06
5	-	-5.2E-06	-21.8E-06	-37.8E-06	-14.2E-06	-32.0E-06	-30.2E-06	12.0E-06	-15.8E-06	-1.8E-06	33.2E-06	41.8E-06	-384.4E-06
Average	-	-133.4E-09	-18.5E-06	-32.6E-06	-11.2E-06	-28.5E-06	-29.2E-06	11.0E-06	-2.6E-06	-16.6E-06	31.7E-06	38.5E-06	-364.1E-06
Sigma	-	5.9E-06	5.3E-06	4.7E-06	4.7E-06	4.9E-06	4.4E-06	4.1E-06	4.0E-06	3.3E-06	2.8E-06	3.9E-06	15.5E-06

Measurements

ICCSBH	0 kRad	10.8 kRad	20.7 kRad	55.6 kRad	102.6 kRad	155.7 kRad	212.4 kRad	268.2 kRad	326.7 kRad	374.2 kRad	416.7 kRad	24 Hours	168 Hours
1_REF	1.8E-03	1.8E-03	1.8E-03	1.8E-03	1.8E-03	1.8E-03	1.8E-03	1.8E-03	1.8E-03	1.8E-03	1.8E-03	1.8E-03	1.8E-03
ON_TID samples													
11	1.8E-03	1.8E-03	1.7E-03	1.7E-03	1.7E-03	1.7E-03	1.7E-03	1.8E-03	1.7E-03	1.7E-03	1.8E-03	1.8E-03	1.4E-03
12	1.8E-03	1.8E-03	1.7E-03	1.7E-03	1.7E-03	1.7E-03	1.7E-03	1.8E-03	1.7E-03	1.7E-03	1.8E-03	1.8E-03	1.4E-03
13	1.8E-03	1.7E-03	1.7E-03	1.7E-03	1.7E-03	1.7E-03	1.7E-03	1.8E-03	1.7E-03	1.7E-03	1.8E-03	1.8E-03	1.4E-03
Statistics													
Min	1.8E-03	1.7E-03	1.7E-03	1.7E-03	1.7E-03	1.7E-03	1.7E-03	1.8E-03	1.7E-03	1.7E-03	1.8E-03	1.8E-03	1.4E-03
Max	1.8E-03	1.8E-03	1.7E-03	1.7E-03	1.7E-03	1.7E-03	1.7E-03	1.8E-03	1.7E-03	1.7E-03	1.8E-03	1.8E-03	1.4E-03
Average	1.8E-03	1.8E-03	1.7E-03	1.7E-03	1.7E-03	1.7E-03	1.7E-03	1.8E-03	1.7E-03	1.7E-03	1.8E-03	1.8E-03	1.4E-03
Sigma	6.6E-06	4.5E-06	4.6E-06	4.5E-06	3.8E-06	1.2E-06	3.4E-06	3.3E-06	3.6E-06	3.4E-06	6.3E-06	4.3E-06	3.0E-06

Drift Calculation

ICCSBH	0 kRad	10.8 kRad	20.7 kRad	55.6 kRad	102.6 kRad	155.7 kRad	212.4 kRad	268.2 kRad	326.7 kRad	374.2 kRad	416.7 kRad	24 Hours	168 Hours
ON_TID samples													
11	-	-15.2E-06	-37.8E-06	-48.4E-06	-33.6E-06	-51.4E-06	-49.2E-06	-10.4E-06	-36.8E-06	-21.0E-06	11.2E-06	18.8E-06	-384.6E-06
12	-	-13.4E-06	-36.2E-06	-46.4E-06	-32.6E-06	-56.4E-06	-49.8E-06	-11.2E-06	-38.8E-06	-24.8E-06	10.4E-06	16.4E-06	-385.0E-06
13	-	-8.2E-06	-31.2E-06	-41.2E-06	-25.6E-06	-43.2E-06	-42.0E-06	-3.2E-06	-31.6E-06	-16.8E-06	11.4E-06	22.2E-06	-376.2E-06
Average	-	-12.3E-06	-35.1E-06	-45.3E-06	-30.6E-06	-50.3E-06	-47.0E-06	-8.3E-06	-35.7E-06	-20.9E-06	11.0E-06	19.1E-06	-381.9E-06
Sigma	-	3.0E-06	2.8E-06	3.0E-06	3.6E-06	5.4E-06	3.5E-06	3.6E-06	3.0E-06	3.3E-06	432.1E-09	2.4E-06	4.1E-06

Hirex Engineering	Total Dose Radiation Test Report										Ref.:	HRX/TID/1013
	HS-4424BRH					Intersil					Issue:	01

**Measurements**

ICCSBH	0 kRad	10.8 kRad	20.7 kRad	55.6 kRad	102.6 kRad	155.7 kRad	212.4 kRad	268.2 kRad	326.7 kRad	374.2 kRad	416.7 kRad	24 Hours	168 Hours
1_REF	1.8E-03	1.8E-03	1.8E-03	1.8E-03	1.8E-03	1.8E-03	1.8E-03	1.8E-03	1.8E-03	1.8E-03	1.8E-03	1.8E-03	1.8E-03
OFF PROTON samples													
6	1.7E-03	1.8E-03	1.7E-03	1.7E-03	1.8E-03	1.8E-03	1.8E-03	1.9E-03	1.9E-03	1.9E-03	2.0E-03	2.0E-03	1.5E-03
7	1.8E-03	1.8E-03	1.8E-03	1.8E-03	1.8E-03	1.8E-03	1.9E-03	1.9E-03	1.9E-03	1.9E-03	2.0E-03	2.1E-03	1.5E-03
14	1.8E-03	1.8E-03	1.8E-03	1.8E-03	1.8E-03	1.8E-03	1.9E-03	1.9E-03	1.9E-03	2.0E-03	2.0E-03	2.1E-03	1.5E-03
Statistics													
Min	1.7E-03	1.8E-03	1.7E-03	1.7E-03	1.8E-03	1.8E-03	1.8E-03	1.9E-03	1.9E-03	1.9E-03	2.0E-03	2.0E-03	1.5E-03
Max	1.8E-03	1.8E-03	1.8E-03	1.8E-03	1.8E-03	1.8E-03	1.9E-03	1.9E-03	1.9E-03	1.9E-03	2.0E-03	2.1E-03	1.5E-03
Average	1.8E-03	1.8E-03	1.8E-03	1.8E-03	1.8E-03	1.8E-03	1.9E-03	1.9E-03	1.9E-03	2.0E-03	2.0E-03	2.0E-03	1.5E-03
Sigma	7.7E-06	8.7E-06	8.3E-06	6.2E-06	11.5E-06	12.2E-06	19.5E-06	24.4E-06	29.1E-06	33.8E-06	36.9E-06	42.2E-06	6.6E-06

**Drift Calculation**

ICCSBH	0 kRad	10.8 kRad	20.7 kRad	55.6 kRad	102.6 kRad	155.7 kRad	212.4 kRad	268.2 kRad	326.7 kRad	374.2 kRad	416.7 kRad	24 Hours	168 Hours
OFF PROTON samples													
6	-	21.2E-06	3.0E-06	8.2E-06	52.6E-06	58.2E-06	85.6E-06	142.0E-06	136.4E-06	168.2E-06	233.8E-06	240.8E-06	-283.0E-06
7	-	22.4E-06	3.2E-06	4.8E-06	59.2E-06	67.8E-06	110.4E-06	177.6E-06	182.0E-06	223.8E-06	304.8E-06	314.4E-06	-300.4E-06
14	-	25.2E-06	6.6E-06	5.0E-06	63.2E-06	68.2E-06	112.0E-06	178.2E-06	182.8E-06	224.6E-06	278.0E-06	314.6E-06	-281.8E-06
Average	-	22.9E-06	4.3E-06	6.0E-06	58.3E-06	64.7E-06	102.7E-06	165.9E-06	167.1E-06	205.5E-06	272.2E-06	289.9E-06	-288.4E-06
Sigma	-	1.7E-06	1.7E-06	1.6E-06	4.4E-06	4.6E-06	12.1E-06	16.9E-06	21.7E-06	26.4E-06	29.3E-06	34.7E-06	8.5E-06

**Measurements**

ICCSBH	0 kRad	10.8 kRad	20.7 kRad	55.6 kRad	102.6 kRad	155.7 kRad	212.4 kRad	268.2 kRad	326.7 kRad	374.2 kRad	416.7 kRad	24 Hours	168 Hours
1_REF	1.8E-03	1.8E-03	1.8E-03	1.8E-03	1.8E-03	1.8E-03	1.8E-03	1.8E-03	1.8E-03	1.8E-03	1.8E-03	1.8E-03	1.8E-03
OFF TID samples													
8	1.8E-03	1.8E-03	1.8E-03	1.8E-03	1.8E-03	1.8E-03	1.8E-03	1.9E-03	1.9E-03	2.0E-03	2.0E-03	2.0E-03	1.5E-03
9	1.8E-03	1.7E-03	1.8E-03	1.8E-03	1.8E-03	1.8E-03	1.8E-03	1.9E-03	1.9E-03	1.9E-03	2.0E-03	2.0E-03	1.5E-03
10	1.8E-03	1.8E-03	1.8E-03	1.8E-03	1.8E-03	1.8E-03	1.8E-03	1.9E-03	1.9E-03	1.9E-03	2.0E-03	2.0E-03	1.5E-03
Statistics													
Min	1.8E-03	1.7E-03	1.8E-03	1.8E-03	1.8E-03	1.8E-03	1.8E-03	1.9E-03	1.9E-03	1.9E-03	2.0E-03	2.0E-03	1.5E-03
Max	1.8E-03	1.8E-03	1.8E-03	1.8E-03	1.8E-03	1.8E-03	1.8E-03	1.9E-03	1.9E-03	1.9E-03	2.0E-03	2.0E-03	1.5E-03
Average	1.8E-03	1.8E-03	1.8E-03	1.8E-03	1.8E-03	1.8E-03	1.8E-03	1.9E-03	1.9E-03	1.9E-03	2.0E-03	2.0E-03	1.5E-03
Sigma	7.5E-06	35.9E-06	7.2E-06	5.9E-06	2.9E-06	3.3E-06	6.9E-06	9.9E-06	14.6E-06	20.1E-06	8.4E-06	21.5E-06	11.7E-06

**Drift Calculation**

ICCSBH	0 kRad	10.8 kRad	20.7 kRad	55.6 kRad	102.6 kRad	155.7 kRad	212.4 kRad	268.2 kRad	326.7 kRad	374.2 kRad	416.7 kRad	24 Hours	168 Hours
OFF TID samples													
8	-	11.4E-06	-8.8E-06	-8.6E-06	38.4E-06	40.8E-06	80.4E-06	145.2E-06	150.8E-06	194.8E-06	244.4E-06	283.4E-06	-294.6E-06
9	-	-58.0E-06	-11.8E-06	-15.4E-06	34.0E-06	31.8E-06	66.2E-06	126.0E-06	123.2E-06	152.2E-06	236.8E-06	243.6E-06	-301.6E-06
10	-	9.0E-06	-11.0E-06	-16.2E-06	26.0E-06	18.8E-06	48.2E-06	105.8E-06	100.4E-06	134.6E-06	207.8E-06	216.8E-06	-289.6E-06
Average	-	-12.5E-06	-10.5E-06	-13.4E-06	32.8E-06	30.5E-06	64.9E-06	125.7E-06	124.8E-06	160.5E-06	229.7E-06	247.9E-06	-295.3E-06
Sigma	-	32.2E-06	1.3E-06	3.4E-06	5.1E-06	9.0E-06	13.2E-06	16.1E-06	20.6E-06	25.3E-06	15.8E-06	27.4E-06	4.9E-06

Parameter : Input Current. Low : IIL\_A

Test conditions : VS=18V

Unit : A

Spec Limit Min : -2.0E-06

Spec Limit Max : 2.0E-06

Spec limits are represented in bold lines on the graphic.

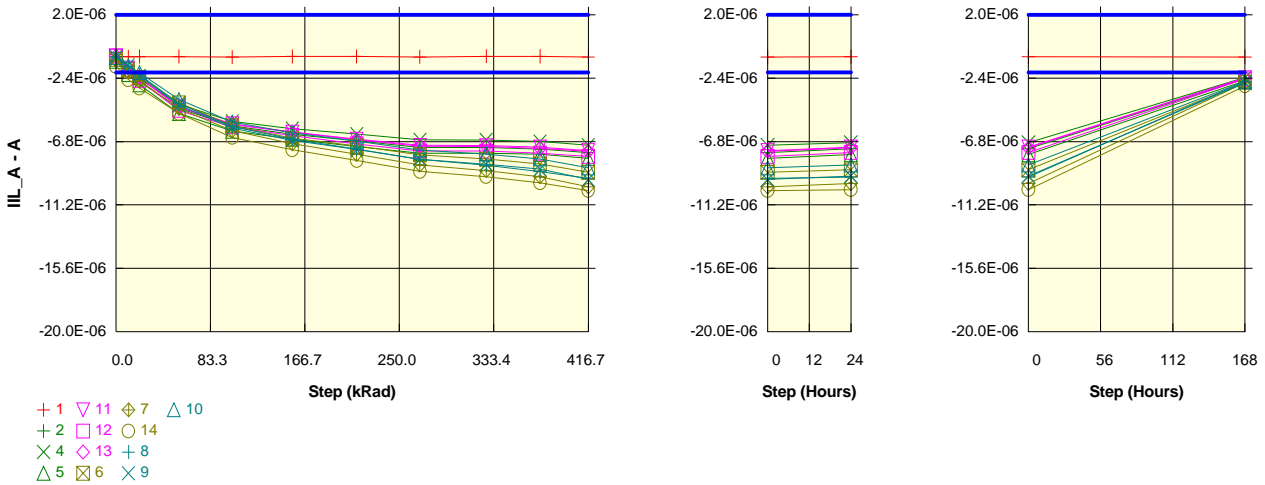

Measurements

IIL_A	0 kRad	10.8 kRad	20.7 kRad	55.6 kRad	102.6 kRad	155.7 kRad	212.4 kRad	268.2 kRad	326.7 kRad	374.2 kRad	416.7 kRad	24 Hours	168 Hours
1_REF	-886.1E-09	-914.4E-09	-905.0E-09	-901.9E-09	-930.6E-09	-893.6E-09	-893.9E-09	-924.7E-09	-881.8E-09	-883.9E-09	-925.4E-09	-914.3E-09	-919.5E-09
ON PROTON samples													
2	-1.1E-06	-2.0E-06	<b>-2.6E-06</b>	<b>-4.5E-06</b>	<b>-5.7E-06</b>	<b>-6.3E-06</b>	<b>-6.7E-06</b>	<b>-7.2E-06</b>	<b>-7.2E-06</b>	<b>-7.3E-06</b>	<b>-7.6E-06</b>	<b>-7.3E-06</b>	<b>-2.5E-06</b>
4	-1.1E-06	-1.9E-06	<b>-2.5E-06</b>	<b>-4.2E-06</b>	<b>-5.4E-06</b>	<b>-5.9E-06</b>	<b>-6.3E-06</b>	<b>-6.7E-06</b>	<b>-6.7E-06</b>	<b>-6.8E-06</b>	<b>-7.1E-06</b>	<b>-6.9E-06</b>	<b>-2.4E-06</b>
5	-1.2E-06	<b>-2.2E-06</b>	<b>-2.9E-06</b>	<b>-4.8E-06</b>	<b>-6.1E-06</b>	<b>-6.6E-06</b>	<b>-7.1E-06</b>	<b>-7.6E-06</b>	<b>-7.6E-06</b>	<b>-7.7E-06</b>	<b>-8.0E-06</b>	<b>-7.7E-06</b>	<b>-2.6E-06</b>
Statistics													
Min	-1.2E-06	-2.2E-06	-2.9E-06	-4.8E-06	-6.1E-06	-6.6E-06	-7.1E-06	-7.6E-06	-7.6E-06	-7.7E-06	-8.0E-06	-7.7E-06	-2.6E-06
Max	-1.1E-06	-1.9E-06	-2.5E-06	-4.2E-06	-5.4E-06	-5.9E-06	-6.3E-06	-6.7E-06	-6.7E-06	-6.8E-06	-7.1E-06	-6.9E-06	-2.4E-06
Average	-1.1E-06	-2.0E-06	-2.6E-06	-4.5E-06	-5.7E-06	-6.3E-06	-6.7E-06	-7.2E-06	-7.2E-06	-7.3E-06	-7.5E-06	-7.3E-06	-2.5E-06
Sigma	61.7E-09	112.6E-09	164.6E-09	259.1E-09	277.0E-09	298.8E-09	354.2E-09	387.7E-09	380.2E-09	364.9E-09	373.4E-09	344.6E-09	92.9E-09

Drift Calculation

IIL_A	0 kRad	10.8 kRad	20.7 kRad	55.6 kRad	102.6 kRad	155.7 kRad	212.4 kRad	268.2 kRad	326.7 kRad	374.2 kRad	416.7 kRad	24 Hours	168 Hours
ON PROTON samples													
2	-	-852.0E-09	-1.5E-06	-3.3E-06	-4.6E-06	-5.2E-06	-5.6E-06	-6.1E-06	-6.1E-06	-6.2E-06	-6.4E-06	-6.2E-06	-1.3E-06
4	-	-809.6E-09	-1.4E-06	-3.1E-06	-4.3E-06	-4.8E-06	-5.2E-06	-5.6E-06	-5.6E-06	-5.7E-06	-6.0E-06	-5.8E-06	-1.3E-06
5	-	-933.4E-09	-1.6E-06	-3.6E-06	-4.9E-06	-5.4E-06	-5.9E-06	-6.4E-06	-6.4E-06	-6.5E-06	-6.7E-06	-6.5E-06	-1.4E-06
Average	-	-865.0E-09	-1.5E-06	-3.4E-06	-4.6E-06	-5.1E-06	-5.6E-06	-6.0E-06	-6.0E-06	-6.1E-06	-6.4E-06	-6.2E-06	-1.3E-06
Sigma	-	51.4E-09	103.6E-09	197.6E-09	215.3E-09	237.1E-09	292.6E-09	326.2E-09	318.6E-09	303.6E-09	311.8E-09	282.9E-09	32.2E-09

Measurements

IIL_A	0 kRad	10.8 kRad	20.7 kRad	55.6 kRad	102.6 kRad	155.7 kRad	212.4 kRad	268.2 kRad	326.7 kRad	374.2 kRad	416.7 kRad	24 Hours	168 Hours
1_REF	-886.1E-09	-914.4E-09	-905.0E-09	-901.9E-09	-930.6E-09	-893.6E-09	-893.9E-09	-924.7E-09	-881.8E-09	-883.9E-09	-925.4E-09	-914.3E-09	-919.5E-09
ON TID samples													
11	-857.7E-09	-1.7E-06	<b>-2.4E-06</b>	<b>-4.4E-06</b>	<b>-5.6E-06</b>	<b>-6.1E-06</b>	<b>-6.6E-06</b>	<b>-7.1E-06</b>	<b>-7.1E-06</b>	<b>-7.2E-06</b>	<b>-7.4E-06</b>	<b>-7.2E-06</b>	<b>-2.4E-06</b>
12	-874.0E-09	-1.8E-06	<b>-2.5E-06</b>	<b>-4.6E-06</b>	<b>-5.8E-06</b>	<b>-6.4E-06</b>	<b>-7.0E-06</b>	<b>-7.4E-06</b>	<b>-7.5E-06</b>	<b>-7.6E-06</b>	<b>-7.8E-06</b>	<b>-7.6E-06</b>	<b>-2.5E-06</b>
13	-847.6E-09	-1.7E-06	<b>-2.4E-06</b>	<b>-4.4E-06</b>	<b>-5.6E-06</b>	<b>-6.2E-06</b>	<b>-6.7E-06</b>	<b>-7.1E-06</b>	<b>-7.1E-06</b>	<b>-7.3E-06</b>	<b>-7.5E-06</b>	<b>-7.2E-06</b>	<b>-2.4E-06</b>
Statistics													
Min	-874.0E-09	-1.8E-06	-2.5E-06	-4.6E-06	-5.8E-06	-6.4E-06	-7.0E-06	-7.4E-06	-7.5E-06	-7.6E-06	-7.8E-06	-7.6E-06	-2.5E-06
Max	-847.6E-09	-1.7E-06	-2.4E-06	-4.4E-06	-5.6E-06	-6.1E-06	-6.6E-06	-7.1E-06	-7.1E-06	-7.2E-06	-7.4E-06	-7.2E-06	-2.4E-06
Average	-859.8E-09	-1.7E-06	-2.4E-06	-4.5E-06	-5.7E-06	-6.2E-06	-6.8E-06	-7.2E-06	-7.2E-06	-7.4E-06	-7.6E-06	-7.3E-06	-2.4E-06
Sigma	10.9E-09	48.0E-09	79.3E-09	111.8E-09	86.7E-09	108.2E-09	144.1E-09	170.9E-09	166.9E-09	182.6E-09	183.4E-09	167.8E-09	32.7E-09

Drift Calculation

IIL_A	0 kRad	10.8 kRad	20.7 kRad	55.6 kRad	102.6 kRad	155.7 kRad	212.4 kRad	268.2 kRad	326.7 kRad	374.2 kRad	416.7 kRad	24 Hours	168 Hours
ON TID samples													
11	-	-835.5E-09	-1.5E-06	-3.5E-06	-4.7E-06	-5.3E-06	-5.8E-06	-6.2E-06	-6.2E-06	-6.3E-06	-6.6E-06	-6.3E-06	-1.5E-06
12	-	-918.6E-09	-1.7E-06	-3.8E-06	-4.9E-06	-5.5E-06	-6.1E-06	-6.6E-06	-6.6E-06	-6.7E-06	-7.0E-06	-6.7E-06	-1.6E-06
13	-	-840.8E-09	-1.5E-06	-3.6E-06	-4.8E-06	-5.3E-06	-5.8E-06	-6.3E-06	-6.3E-06	-6.4E-06	-6.6E-06	-6.4E-06	-1.5E-06
Average	-	-865.0E-09	-1.6E-06	-3.6E-06	-4.8E-06	-5.4E-06	-5.9E-06	-6.4E-06	-6.4E-06	-6.5E-06	-6.7E-06	-6.5E-06	-1.6E-06
Sigma	-	38.0E-09	69.4E-09	102.6E-09	78.0E-09	98.7E-09	134.5E-09	161.5E-09	157.6E-09	173.9E-09	173.9E-09	158.5E-09	24.2E-09

Hirex Engineering	Total Dose Radiation Test Report									Ref.:	HRX/TID/1013
	HS-4424BRH				Intersil					Issue:	01

**Measurements**

IIL_A	0 kRad	10.8 kRad	20.7 kRad	55.6 kRad	102.6 kRad	155.7 kRad	212.4 kRad	268.2 kRad	326.7 kRad	374.2 kRad	416.7 kRad	24 Hours	168 Hours
1_REF	-886.1E-09	-914.4E-09	-905.0E-09	-901.9E-09	-930.6E-09	-893.6E-09	-893.9E-09	-924.7E-09	-881.8E-09	-883.9E-09	-925.4E-09	-914.3E-09	-919.5E-09
OFF PROTON samples													
6	-1.1E-06	-1.8E-06	-2.4E-06	-4.1E-06	-5.7E-06	-6.6E-06	-7.1E-06	-7.7E-06	-8.0E-06	-8.4E-06	-8.9E-06	-8.8E-06	-2.7E-06
7	-1.2E-06	-2.0E-06	-2.6E-06	-4.5E-06	-6.0E-06	-7.0E-06	-7.7E-06	-8.4E-06	-8.8E-06	-9.2E-06	-9.9E-06	-9.7E-06	-2.7E-06
14	-1.6E-06	-2.5E-06	-3.1E-06	-4.8E-06	-6.5E-06	-7.4E-06	-8.1E-06	-8.9E-06	-9.2E-06	-9.7E-06	-10.2E-06	-10.1E-06	-2.9E-06
Statistics													
Min	-1.6E-06	-2.5E-06	-3.1E-06	-4.8E-06	-6.5E-06	-7.4E-06	-8.1E-06	-8.9E-06	-9.2E-06	-9.7E-06	-10.2E-06	-10.1E-06	-2.9E-06
Max	-1.1E-06	-1.8E-06	-2.4E-06	-4.1E-06	-5.7E-06	-6.6E-06	-7.1E-06	-7.7E-06	-8.0E-06	-8.4E-06	-8.9E-06	-8.8E-06	-2.7E-06
Average	-1.3E-06	-2.1E-06	-2.7E-06	-4.5E-06	-6.1E-06	-7.0E-06	-7.6E-06	-8.3E-06	-8.7E-06	-9.1E-06	-9.7E-06	-9.5E-06	-2.8E-06
Sigma	224.9E-09	294.7E-09	305.3E-09	301.0E-09	331.7E-09	329.1E-09	410.5E-09	473.8E-09	504.3E-09	543.9E-09	545.9E-09	576.9E-09	112.1E-09

**Drift Calculation**

IIL_A	0 kRad	10.8 kRad	20.7 kRad	55.6 kRad	102.6 kRad	155.7 kRad	212.4 kRad	268.2 kRad	326.7 kRad	374.2 kRad	416.7 kRad	24 Hours	168 Hours
OFF PROTON samples													
6	-	-723.4E-09	-1.3E-06	-3.0E-06	-4.6E-06	-5.5E-06	-6.0E-06	-6.6E-06	-6.9E-06	-7.3E-06	-7.8E-06	-7.7E-06	-1.6E-06
7	-	-814.0E-09	-1.4E-06	-3.4E-06	-4.9E-06	-5.8E-06	-6.5E-06	-7.3E-06	-7.7E-06	-8.1E-06	-8.8E-06	-8.6E-06	-1.6E-06
14	-	-906.2E-09	-1.5E-06	-3.2E-06	-4.9E-06	-5.8E-06	-6.5E-06	-7.3E-06	-7.6E-06	-8.1E-06	-8.6E-06	-8.5E-06	-1.3E-06
Average	-	-814.5E-09	-1.4E-06	-3.2E-06	-4.8E-06	-5.7E-06	-6.4E-06	-7.1E-06	-7.4E-06	-7.8E-06	-8.4E-06	-8.3E-06	-1.5E-06
Sigma	-	74.6E-09	94.2E-09	142.3E-09	139.3E-09	150.2E-09	240.6E-09	305.0E-09	342.1E-09	385.2E-09	410.4E-09	418.0E-09	112.9E-09

**Measurements**

IIL_A	0 kRad	10.8 kRad	20.7 kRad	55.6 kRad	102.6 kRad	155.7 kRad	212.4 kRad	268.2 kRad	326.7 kRad	374.2 kRad	416.7 kRad	24 Hours	168 Hours
1_REF	-886.1E-09	-914.4E-09	-905.0E-09	-901.9E-09	-930.6E-09	-893.6E-09	-893.9E-09	-924.7E-09	-881.8E-09	-883.9E-09	-925.4E-09	-914.3E-09	-919.5E-09
OFF TID samples													
8	-896.2E-09	-1.6E-06	-2.2E-06	-4.2E-06	-5.8E-06	-6.6E-06	-7.3E-06	-8.0E-06	-8.4E-06	-8.9E-06	-9.4E-06	-9.3E-06	-2.6E-06
9	-907.0E-09	-1.5E-06	-2.2E-06	-4.3E-06	-5.9E-06	-6.7E-06	-7.4E-06	-8.0E-06	-8.4E-06	-8.7E-06	-9.4E-06	-9.2E-06	-2.7E-06
10	-951.2E-09	-1.5E-06	-2.0E-06	-3.9E-06	-5.5E-06	-6.2E-06	-6.8E-06	-7.4E-06	-7.7E-06	-8.0E-06	-8.6E-06	-8.4E-06	-2.6E-06
Statistics													
Min	-951.2E-09	-1.6E-06	-2.2E-06	-4.3E-06	-5.9E-06	-6.7E-06	-7.4E-06	-8.0E-06	-8.4E-06	-8.9E-06	-9.4E-06	-9.3E-06	-2.7E-06
Max	-896.2E-09	-1.5E-06	-2.0E-06	-3.9E-06	-5.5E-06	-6.2E-06	-6.8E-06	-7.4E-06	-7.7E-06	-8.0E-06	-8.6E-06	-8.4E-06	-2.6E-06
Average	-918.1E-09	-1.5E-06	-2.1E-06	-4.1E-06	-5.7E-06	-6.5E-06	-7.1E-06	-7.8E-06	-8.2E-06	-8.5E-06	-9.1E-06	-9.0E-06	-2.7E-06
Sigma	23.8E-09	31.8E-09	89.0E-09	170.6E-09	174.4E-09	217.3E-09	266.4E-09	308.8E-09	347.8E-09	375.5E-09	359.9E-09	385.6E-09	41.8E-09

**Drift Calculation**

IIL_A	0 kRad	10.8 kRad	20.7 kRad	55.6 kRad	102.6 kRad	155.7 kRad	212.4 kRad	268.2 kRad	326.7 kRad	374.2 kRad	416.7 kRad	24 Hours	168 Hours
OFF TID samples													
8	-	-681.2E-09	-1.3E-06	-3.3E-06	-4.9E-06	-5.7E-06	-6.4E-06	-7.2E-06	-7.6E-06	-8.0E-06	-8.5E-06	-8.4E-06	-1.7E-06
9	-	-592.6E-09	-1.3E-06	-3.4E-06	-5.0E-06	-5.8E-06	-6.4E-06	-7.1E-06	-7.5E-06	-7.8E-06	-8.5E-06	-8.3E-06	-1.8E-06
10	-	-585.4E-09	-1.1E-06	-2.9E-06	-4.5E-06	-5.3E-06	-5.8E-06	-6.4E-06	-6.7E-06	-7.1E-06	-7.7E-06	-7.5E-06	-1.7E-06
Average	-	-619.7E-09	-1.2E-06	-3.2E-06	-4.8E-06	-5.6E-06	-6.2E-06	-6.9E-06	-7.3E-06	-7.6E-06	-8.2E-06	-8.0E-06	-1.7E-06
Sigma	-	43.6E-09	110.4E-09	192.2E-09	196.1E-09	239.9E-09	289.7E-09	332.4E-09	371.5E-09	399.3E-09	383.0E-09	409.3E-09	55.2E-09



Parameter : Input Current. Low : IIL\_B

Test conditions : VS=18V

Unit : A

Spec Limit Min : -2.0E-06

Spec Limit Max : 2.0E-06

Spec limits are represented in bold lines on the graphic.

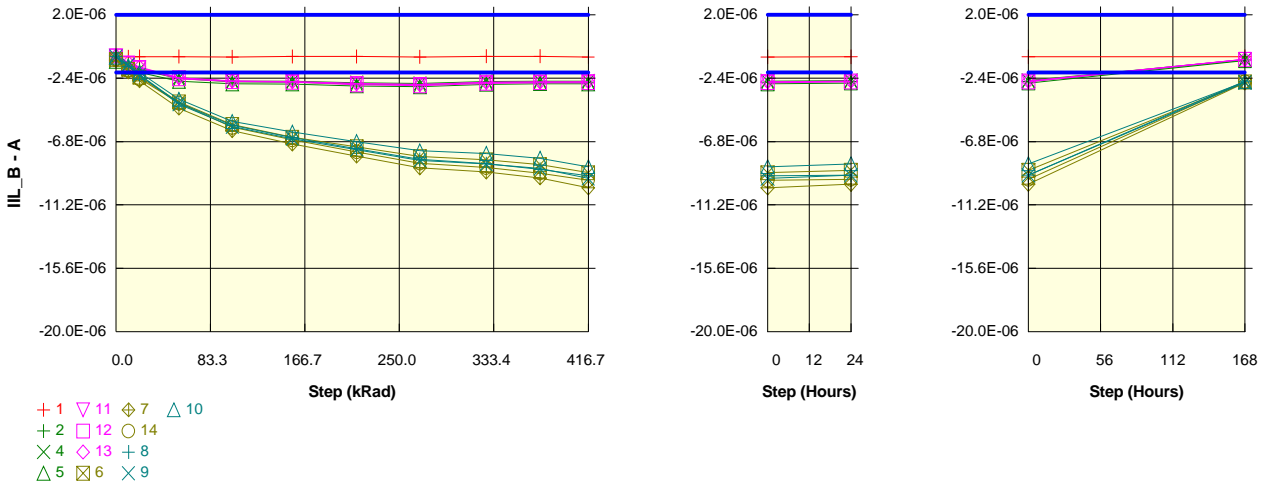

Measurements

IIL_B	0 kRad	10.8 kRad	20.7 kRad	55.6 kRad	102.6 kRad	155.7 kRad	212.4 kRad	268.2 kRad	326.7 kRad	374.2 kRad	416.7 kRad	24 Hours	168 Hours
1_REF	-883.3E-09	-911.4E-09	-902.2E-09	-899.3E-09	-928.1E-09	-890.8E-09	-891.2E-09	-921.9E-09	-879.1E-09	-880.9E-09	-922.7E-09	-911.3E-09	-916.4E-09
ON PROTON samples													
2	-1.1E-06	-1.5E-06	-1.8E-06	<b>-2.4E-06</b>	<b>-2.6E-06</b>	<b>-2.7E-06</b>	<b>-2.8E-06</b>	<b>-2.9E-06</b>	<b>-2.7E-06</b>	<b>-2.7E-06</b>	<b>-2.7E-06</b>	<b>-2.6E-06</b>	-1.1E-06
4	-1.1E-06	-1.5E-06	-1.8E-06	<b>-2.4E-06</b>	<b>-2.6E-06</b>	<b>-2.6E-06</b>	<b>-2.7E-06</b>	<b>-2.8E-06</b>	<b>-2.6E-06</b>	<b>-2.6E-06</b>	<b>-2.6E-06</b>	<b>-2.6E-06</b>	-1.1E-06
5	-1.2E-06	-1.7E-06	-2.0E-06	<b>-2.6E-06</b>	<b>-2.8E-06</b>	<b>-2.8E-06</b>	<b>-2.9E-06</b>	<b>-3.0E-06</b>	<b>-2.8E-06</b>	<b>-2.8E-06</b>	<b>-2.8E-06</b>	<b>-2.7E-06</b>	-1.2E-06
Statistics													
Min	-1.2E-06	-1.7E-06	-2.0E-06	-2.6E-06	-2.8E-06	-2.8E-06	-2.9E-06	-3.0E-06	-2.8E-06	-2.8E-06	-2.8E-06	-2.7E-06	-1.2E-06
Max	-1.1E-06	-1.5E-06	-1.8E-06	-2.4E-06	-2.6E-06	-2.6E-06	-2.7E-06	-2.8E-06	-2.6E-06	-2.6E-06	-2.6E-06	-2.6E-06	-1.1E-06
Average	-1.1E-06	-1.6E-06	-1.9E-06	-2.5E-06	-2.7E-06	-2.7E-06	-2.8E-06	-2.9E-06	-2.7E-06	-2.7E-06	-2.7E-06	-2.6E-06	-1.1E-06
Sigma	64.2E-09	76.7E-09	90.4E-09	99.8E-09	83.9E-09	79.1E-09	88.7E-09	91.2E-09	81.6E-09	73.5E-09	75.0E-09	70.6E-09	29.6E-09

Drift Calculation

IIL_B	0 kRad	10.8 kRad	20.7 kRad	55.6 kRad	102.6 kRad	155.7 kRad	212.4 kRad	268.2 kRad	326.7 kRad	374.2 kRad	416.7 kRad	24 Hours	168 Hours
ON PROTON samples													
2	-	-428.8E-09	-720.4E-09	-1.3E-06	-1.5E-06	-1.6E-06	-1.7E-06	-1.8E-06	-1.6E-06	-1.6E-06	-1.6E-06	-1.5E-06	-30.0E-09
4	-	-421.2E-09	-700.2E-09	-1.3E-06	-1.5E-06	-1.5E-06	-1.6E-06	-1.7E-06	-1.5E-06	-1.5E-06	-1.5E-06	-1.5E-06	-31.8E-09
5	-	-451.0E-09	-764.0E-09	-1.4E-06	-1.6E-06	-1.6E-06	-1.7E-06	-1.8E-06	-1.6E-06	-1.6E-06	-1.6E-06	-1.5E-06	43.0E-09
Average	-	-433.7E-09	-728.2E-09	-1.3E-06	-1.5E-06	-1.6E-06	-1.7E-06	-1.7E-06	-1.6E-06	-1.5E-06	-1.6E-06	-1.5E-06	-6.3E-09
Sigma	-	12.6E-09	26.6E-09	37.6E-09	22.2E-09	19.0E-09	32.4E-09	33.9E-09	28.5E-09	25.0E-09	25.2E-09	17.4E-09	34.8E-09

Measurements

IIL_B	0 kRad	10.8 kRad	20.7 kRad	55.6 kRad	102.6 kRad	155.7 kRad	212.4 kRad	268.2 kRad	326.7 kRad	374.2 kRad	416.7 kRad	24 Hours	168 Hours
1_REF	-883.3E-09	-911.4E-09	-902.2E-09	-899.3E-09	-928.1E-09	-890.8E-09	-891.2E-09	-921.9E-09	-879.1E-09	-880.9E-09	-922.7E-09	-911.3E-09	-916.4E-09
ON TID samples													
11	-873.1E-09	-1.3E-06	-1.7E-06	<b>-2.4E-06</b>	<b>-2.6E-06</b>	<b>-2.6E-06</b>	<b>-2.8E-06</b>	<b>-2.8E-06</b>	<b>-2.7E-06</b>	<b>-2.7E-06</b>	<b>-2.6E-06</b>	<b>-2.6E-06</b>	-1.1E-06
12	-856.4E-09	-1.4E-06	-1.7E-06	<b>-2.4E-06</b>	<b>-2.6E-06</b>	<b>-2.7E-06</b>	<b>-2.9E-06</b>	<b>-2.9E-06</b>	<b>-2.8E-06</b>	<b>-2.7E-06</b>	<b>-2.7E-06</b>	<b>-2.7E-06</b>	-1.1E-06
13	-847.2E-09	-1.3E-06	-1.6E-06	<b>-2.4E-06</b>	<b>-2.6E-06</b>	<b>-2.6E-06</b>	<b>-2.8E-06</b>	<b>-2.8E-06</b>	<b>-2.7E-06</b>	<b>-2.7E-06</b>	<b>-2.6E-06</b>	<b>-2.6E-06</b>	-1.1E-06
Statistics													
Min	-873.1E-09	-1.4E-06	-1.7E-06	-2.4E-06	-2.6E-06	-2.7E-06	-2.9E-06	-2.9E-06	-2.8E-06	-2.7E-06	-2.7E-06	-2.7E-06	-1.1E-06
Max	-847.2E-09	-1.3E-06	-1.6E-06	-2.4E-06	-2.6E-06	-2.6E-06	-2.8E-06	-2.8E-06	-2.7E-06	-2.7E-06	-2.6E-06	-2.6E-06	-1.1E-06
Average	-858.9E-09	-1.3E-06	-1.7E-06	-2.4E-06	-2.6E-06	-2.6E-06	-2.8E-06	-2.9E-06	-2.7E-06	-2.7E-06	-2.7E-06	-2.6E-06	-1.1E-06
Sigma	10.8E-09	18.1E-09	30.1E-09	31.1E-09	19.3E-09	24.2E-09	35.6E-09	38.5E-09	33.3E-09	27.5E-09	33.3E-09	25.3E-09	2.5E-09

Drift Calculation

IIL_B	0 kRad	10.8 kRad	20.7 kRad	55.6 kRad	102.6 kRad	155.7 kRad	212.4 kRad	268.2 kRad	326.7 kRad	374.2 kRad	416.7 kRad	24 Hours	168 Hours
ON TID samples													
11	-	-466.1E-09	-788.1E-09	-1.5E-06	-1.7E-06	-1.7E-06	-1.9E-06	-2.0E-06	-1.8E-06	-1.8E-06	-1.8E-06	-1.7E-06	-220.1E-09
12	-	-498.8E-09	-849.4E-09	-1.6E-06	-1.8E-06	-1.8E-06	-2.0E-06	-2.1E-06	-1.9E-06	-1.9E-06	-1.9E-06	-1.8E-06	-235.0E-09
13	-	-464.2E-09	-785.4E-09	-1.5E-06	-1.7E-06	-1.8E-06	-1.9E-06	-2.0E-06	-1.8E-06	-1.8E-06	-1.8E-06	-1.8E-06	-240.0E-09
Average	-	-476.4E-09	-807.6E-09	-1.5E-06	-1.7E-06	-1.8E-06	-1.9E-06	-2.0E-06	-1.8E-06	-1.8E-06	-1.8E-06	-1.8E-06	-231.7E-09
Sigma	-	15.9E-09	29.6E-09	35.1E-09	24.3E-09	31.3E-09	41.4E-09	43.1E-09	38.7E-09	32.7E-09	36.3E-09	29.8E-09	8.5E-09

Hirex Engineering	Total Dose Radiation Test Report									Ref.:	HRX/TID/1013
	HS-4424BRH					Intersil				Issue:	01

**Measurements**

IIL_B	0 kRad	10.8 kRad	20.7 kRad	55.6 kRad	102.6 kRad	155.7 kRad	212.4 kRad	268.2 kRad	326.7 kRad	374.2 kRad	416.7 kRad	24 Hours	168 Hours
1_REF	-883.3E-09	-911.4E-09	-902.2E-09	-899.3E-09	-928.1E-09	-890.8E-09	-891.2E-09	-921.9E-09	-879.1E-09	-880.9E-09	-922.7E-09	-911.3E-09	-916.4E-09
OFF PROTON samples													
6	-1.1E-06	-1.8E-06	-2.3E-06	-4.0E-06	-5.6E-06	-6.5E-06	-7.2E-06	-7.8E-06	-8.1E-06	-8.4E-06	-9.0E-06	-8.8E-06	-2.7E-06
7	-1.2E-06	-2.0E-06	-2.6E-06	-4.5E-06	-6.0E-06	-7.0E-06	-7.8E-06	-8.6E-06	-8.9E-06	-9.3E-06	-10.0E-06	-9.8E-06	-2.7E-06
14	-1.1E-06	-1.9E-06	-2.4E-06	-4.1E-06	-5.8E-06	-6.7E-06	-7.5E-06	-8.3E-06	-8.6E-06	-9.0E-06	-9.5E-06	-9.4E-06	-2.7E-06
Statistics													
Min	-1.2E-06	-2.0E-06	-2.6E-06	-4.5E-06	-6.0E-06	-7.0E-06	-7.8E-06	-8.6E-06	-8.9E-06	-9.3E-06	-10.0E-06	-9.8E-06	-2.7E-06
Max	-1.1E-06	-1.8E-06	-2.3E-06	-4.0E-06	-5.6E-06	-6.5E-06	-7.2E-06	-7.8E-06	-8.1E-06	-8.4E-06	-9.0E-06	-8.8E-06	-2.7E-06
Average	-1.1E-06	-1.9E-06	-2.4E-06	-4.2E-06	-5.8E-06	-6.7E-06	-7.5E-06	-8.3E-06	-8.5E-06	-8.9E-06	-9.5E-06	-9.3E-06	-2.7E-06
Sigma	30.8E-09	73.9E-09	104.4E-09	184.7E-09	173.6E-09	192.6E-09	263.2E-09	319.5E-09	352.1E-09	386.7E-09	429.2E-09	402.2E-09	27.7E-09

**Drift Calculation**

IIL_B	0 kRad	10.8 kRad	20.7 kRad	55.6 kRad	102.6 kRad	155.7 kRad	212.4 kRad	268.2 kRad	326.7 kRad	374.2 kRad	416.7 kRad	24 Hours	168 Hours
OFF PROTON samples													
6	-	-701.0E-09	-1.2E-06	-3.0E-06	-4.5E-06	-5.4E-06	-6.1E-06	-6.8E-06	-7.0E-06	-7.3E-06	-7.9E-06	-7.7E-06	-1.6E-06
7	-	-810.6E-09	-1.4E-06	-3.3E-06	-4.9E-06	-5.8E-06	-6.6E-06	-7.5E-06	-7.8E-06	-8.2E-06	-8.9E-06	-8.6E-06	-1.6E-06
14	-	-763.2E-09	-1.3E-06	-3.0E-06	-4.7E-06	-5.6E-06	-6.4E-06	-7.2E-06	-7.5E-06	-7.9E-06	-8.4E-06	-8.3E-06	-1.6E-06
Average	-	-758.3E-09	-1.3E-06	-3.1E-06	-4.7E-06	-5.6E-06	-6.4E-06	-7.1E-06	-7.4E-06	-7.8E-06	-8.4E-06	-8.2E-06	-1.6E-06
Sigma	-	44.9E-09	75.4E-09	153.9E-09	144.3E-09	162.7E-09	235.4E-09	292.3E-09	325.5E-09	360.4E-09	400.7E-09	375.9E-09	11.1E-09

**Measurements**

IIL_B	0 kRad	10.8 kRad	20.7 kRad	55.6 kRad	102.6 kRad	155.7 kRad	212.4 kRad	268.2 kRad	326.7 kRad	374.2 kRad	416.7 kRad	24 Hours	168 Hours
1_REF	-883.3E-09	-911.4E-09	-902.2E-09	-899.3E-09	-928.1E-09	-890.8E-09	-891.2E-09	-921.9E-09	-879.1E-09	-880.9E-09	-922.7E-09	-911.3E-09	-916.4E-09
OFF TID samples													
8	-884.2E-09	-1.6E-06	-2.2E-06	-4.1E-06	-5.7E-06	-6.5E-06	-7.3E-06	-8.0E-06	-8.3E-06	-8.7E-06	-9.2E-06	-9.1E-06	-2.6E-06
9	-892.7E-09	-1.5E-06	-2.2E-06	-4.2E-06	-5.8E-06	-6.6E-06	-7.4E-06	-8.1E-06	-8.4E-06	-8.7E-06	-9.4E-06	-9.1E-06	-2.7E-06
10	-948.4E-09	-1.5E-06	-2.0E-06	-3.9E-06	-5.4E-06	-6.1E-06	-6.8E-06	-7.4E-06	-7.6E-06	-8.0E-06	-8.5E-06	-8.3E-06	-2.6E-06
Statistics													
Min	-948.4E-09	-1.6E-06	-2.2E-06	-4.2E-06	-5.8E-06	-6.6E-06	-7.4E-06	-8.1E-06	-8.4E-06	-8.7E-06	-9.4E-06	-9.1E-06	-2.7E-06
Max	-884.2E-09	-1.5E-06	-2.0E-06	-3.9E-06	-5.4E-06	-6.1E-06	-6.8E-06	-7.4E-06	-7.6E-06	-8.0E-06	-8.5E-06	-8.3E-06	-2.6E-06
Average	-908.4E-09	-1.5E-06	-2.1E-06	-4.1E-06	-5.6E-06	-6.4E-06	-7.2E-06	-7.9E-06	-8.1E-06	-8.5E-06	-9.0E-06	-8.9E-06	-2.6E-06
Sigma	28.5E-09	40.2E-09	79.0E-09	150.2E-09	152.8E-09	200.4E-09	252.6E-09	298.1E-09	335.3E-09	346.4E-09	351.2E-09	371.9E-09	42.2E-09

**Drift Calculation**

IIL_B	0 kRad	10.8 kRad	20.7 kRad	55.6 kRad	102.6 kRad	155.7 kRad	212.4 kRad	268.2 kRad	326.7 kRad	374.2 kRad	416.7 kRad	24 Hours	168 Hours
OFF TID samples													
8	-	-686.4E-09	-1.3E-06	-3.2E-06	-4.8E-06	-5.6E-06	-6.4E-06	-7.2E-06	-7.4E-06	-7.8E-06	-8.3E-06	-8.2E-06	-1.7E-06
9	-	-580.3E-09	-1.3E-06	-3.3E-06	-4.9E-06	-5.7E-06	-6.5E-06	-7.2E-06	-7.5E-06	-7.8E-06	-8.5E-06	-8.3E-06	-1.8E-06
10	-	-585.0E-09	-1.1E-06	-2.9E-06	-4.5E-06	-5.2E-06	-5.9E-06	-6.5E-06	-6.7E-06	-7.0E-06	-7.6E-06	-7.4E-06	-1.7E-06
Average	-	-617.2E-09	-1.2E-06	-3.2E-06	-4.7E-06	-5.5E-06	-6.2E-06	-7.0E-06	-7.2E-06	-7.5E-06	-8.1E-06	-8.0E-06	-1.7E-06
Sigma	-	48.9E-09	106.8E-09	177.2E-09	179.5E-09	227.7E-09	280.3E-09	326.0E-09	363.5E-09	374.8E-09	378.2E-09	400.1E-09	49.8E-09

Parameter : Input Current. High : IIH\_A

Test conditions : VS=18V

Unit : A

Spec Limit Min : -2.0E-06

Spec Limit Max : 2.0E-06

Spec limits are represented in bold lines on the graphic.

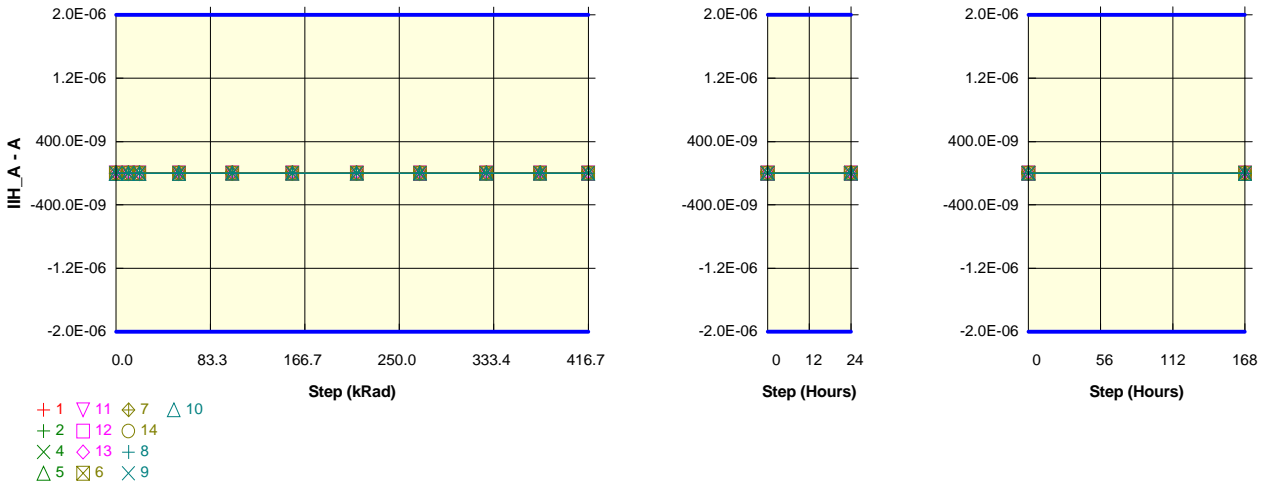

Measurements

IIH_A	0 kRad	10.8 kRad	20.7 kRad	55.6 kRad	102.6 kRad	155.7 kRad	212.4 kRad	268.2 kRad	326.7 kRad	374.2 kRad	416.7 kRad	24 Hours	168 Hours
1_REF	9.5E-12	14.0E-12	28.0E-12	15.4E-12	81.3E-12	14.2E-12	25.2E-12	14.8E-12	14.5E-12	19.6E-12	17.5E-12	19.9E-12	14.8E-12
ON PROTON samples													
2	27.0E-12	37.2E-12	63.5E-12	75.1E-12	136.5E-12	102.3E-12	123.3E-12	77.7E-12	116.8E-12	115.3E-12	86.1E-12	68.9E-12	26.8E-12
4	16.5E-12	38.2E-12	63.6E-12	75.7E-12	141.4E-12	101.1E-12	122.5E-12	78.5E-12	119.5E-12	118.9E-12	179.4E-12	85.9E-12	40.5E-12
5	22.6E-12	43.7E-12	68.3E-12	83.1E-12	150.6E-12	114.2E-12	130.4E-12	83.2E-12	125.9E-12	128.3E-12	95.3E-12	72.2E-12	44.5E-12
Statistics													
Min	16.5E-12	37.2E-12	63.5E-12	75.1E-12	136.5E-12	101.1E-12	122.5E-12	77.7E-12	116.8E-12	115.3E-12	86.1E-12	68.9E-12	26.8E-12
Max	27.0E-12	43.7E-12	68.3E-12	83.1E-12	150.6E-12	114.2E-12	130.4E-12	83.2E-12	125.9E-12	128.3E-12	179.4E-12	85.9E-12	44.5E-12
Average	22.0E-12	39.7E-12	65.1E-12	78.0E-12	142.8E-12	105.9E-12	125.4E-12	79.8E-12	120.7E-12	120.9E-12	120.3E-12	75.7E-12	37.3E-12
Sigma	4.3E-12	2.8E-12	2.2E-12	3.7E-12	5.9E-12	5.9E-12	3.5E-12	2.4E-12	3.8E-12	5.5E-12	42.0E-12	7.4E-12	7.6E-12

Drift Calculation

IIH_A	0 kRad	10.8 kRad	20.7 kRad	55.6 kRad	102.6 kRad	155.7 kRad	212.4 kRad	268.2 kRad	326.7 kRad	374.2 kRad	416.7 kRad	24 Hours	168 Hours
ON PROTON samples													
2	-	10.2E-12	36.5E-12	48.1E-12	109.4E-12	75.3E-12	96.3E-12	50.7E-12	89.7E-12	88.3E-12	59.0E-12	41.9E-12	-260.0E-15
4	-	21.7E-12	47.1E-12	59.2E-12	124.9E-12	84.7E-12	106.0E-12	62.0E-12	103.0E-12	102.5E-12	162.9E-12	69.5E-12	24.1E-12
5	-	21.1E-12	45.7E-12	60.6E-12	128.0E-12	91.6E-12	107.8E-12	60.7E-12	103.3E-12	105.8E-12	72.8E-12	49.6E-12	21.9E-12
Average	-	17.7E-12	43.1E-12	56.0E-12	120.8E-12	83.9E-12	103.4E-12	57.8E-12	98.7E-12	98.8E-12	98.2E-12	53.7E-12	15.2E-12
Sigma	-	5.3E-12	4.7E-12	5.6E-12	8.1E-12	6.7E-12	5.1E-12	5.1E-12	6.3E-12	7.6E-12	46.1E-12	11.6E-12	11.0E-12

Measurements

IIH_A	0 kRad	10.8 kRad	20.7 kRad	55.6 kRad	102.6 kRad	155.7 kRad	212.4 kRad	268.2 kRad	326.7 kRad	374.2 kRad	416.7 kRad	24 Hours	168 Hours
1_REF	9.5E-12	14.0E-12	28.0E-12	15.4E-12	81.3E-12	14.2E-12	25.2E-12	14.8E-12	14.5E-12	19.6E-12	17.5E-12	19.9E-12	14.8E-12
ON TID samples													
11	16.6E-12	36.0E-12	62.8E-12	74.3E-12	135.9E-12	104.2E-12	126.3E-12	80.2E-12	123.2E-12	123.2E-12	92.2E-12	85.3E-12	40.5E-12
12	8.4E-12	34.6E-12	66.1E-12	77.6E-12	138.2E-12	120.7E-12	132.5E-12	82.2E-12	130.1E-12	130.5E-12	92.6E-12	85.2E-12	28.8E-12
13	13.7E-12	33.8E-12	62.8E-12	74.0E-12	130.5E-12	106.8E-12	128.0E-12	87.3E-12	126.4E-12	122.0E-12	97.6E-12	89.6E-12	27.2E-12
Statistics													
Min	8.4E-12	33.8E-12	62.8E-12	74.0E-12	130.5E-12	104.2E-12	126.3E-12	80.2E-12	123.2E-12	122.0E-12	92.2E-12	85.2E-12	27.2E-12
Max	16.6E-12	36.0E-12	66.1E-12	77.6E-12	138.2E-12	120.7E-12	132.5E-12	87.3E-12	130.1E-12	130.5E-12	97.6E-12	89.6E-12	40.5E-12
Average	12.9E-12	34.8E-12	63.9E-12	75.3E-12	134.9E-12	110.6E-12	128.9E-12	83.2E-12	126.6E-12	125.2E-12	94.1E-12	86.7E-12	32.2E-12
Sigma	3.4E-12	906.9E-15	1.6E-12	1.6E-12	3.3E-12	7.2E-12	2.6E-12	3.0E-12	2.8E-12	3.7E-12	2.5E-12	2.0E-12	5.9E-12

Drift Calculation

IIH_A	0 kRad	10.8 kRad	20.7 kRad	55.6 kRad	102.6 kRad	155.7 kRad	212.4 kRad	268.2 kRad	326.7 kRad	374.2 kRad	416.7 kRad	24 Hours	168 Hours
ON TID samples													
11	-	19.4E-12	46.2E-12	57.7E-12	119.3E-12	87.6E-12	109.7E-12	63.6E-12	106.6E-12	106.6E-12	75.6E-12	68.7E-12	23.9E-12
12	-	26.2E-12	57.7E-12	69.2E-12	129.8E-12	112.4E-12	124.1E-12	73.9E-12	121.7E-12	122.1E-12	84.2E-12	76.8E-12	20.4E-12
13	-	20.1E-12	49.1E-12	60.3E-12	116.8E-12	93.1E-12	114.3E-12	73.6E-12	112.7E-12	108.3E-12	83.9E-12	75.9E-12	13.5E-12
Average	-	21.9E-12	51.0E-12	62.4E-12	122.0E-12	97.7E-12	116.0E-12	70.3E-12	113.7E-12	112.3E-12	81.2E-12	73.8E-12	19.3E-12
Sigma	-	3.0E-12	4.9E-12	5.0E-12	5.7E-12	10.6E-12	6.0E-12	4.8E-12	6.2E-12	6.9E-12	4.0E-12	3.6E-12	4.3E-12

Hirex Engineering	Total Dose Radiation Test Report										Ref.:	HRX/TID/1013
	HS-4424BRH					Intersil					Issue:	01

**Measurements**

IIH_A	0 kRad	10.8 kRad	20.7 kRad	55.6 kRad	102.6 kRad	155.7 kRad	212.4 kRad	268.2 kRad	326.7 kRad	374.2 kRad	416.7 kRad	24 Hours	168 Hours
1_REF	9.5E-12	14.0E-12	28.0E-12	15.4E-12	81.3E-12	14.2E-12	25.2E-12	14.8E-12	14.5E-12	19.6E-12	17.5E-12	19.9E-12	14.8E-12
OFF PROTON samples													
6	15.6E-12	43.1E-12	77.2E-12	95.2E-12	147.2E-12	166.9E-12	172.9E-12	131.8E-12	200.7E-12	216.8E-12	168.3E-12	152.9E-12	96.4E-12
7	24.9E-12	43.0E-12	153.0E-12	106.9E-12	139.6E-12	185.6E-12	183.8E-12	137.3E-12	217.7E-12	231.6E-12	180.1E-12	163.6E-12	46.3E-12
14	29.6E-12	51.6E-12	86.8E-12	105.9E-12	145.5E-12	187.1E-12	180.3E-12	134.5E-12	212.1E-12	222.7E-12	215.4E-12	152.9E-12	49.6E-12
Statistics													
Min	15.6E-12	43.0E-12	77.2E-12	95.2E-12	139.6E-12	166.9E-12	172.9E-12	131.8E-12	200.7E-12	216.8E-12	168.3E-12	152.9E-12	46.3E-12
Max	29.6E-12	51.6E-12	153.0E-12	106.9E-12	147.2E-12	187.1E-12	183.8E-12	137.3E-12	217.7E-12	231.6E-12	215.4E-12	163.6E-12	96.4E-12
Average	23.3E-12	45.9E-12	105.7E-12	102.7E-12	144.1E-12	179.9E-12	179.0E-12	134.5E-12	210.2E-12	223.7E-12	187.9E-12	156.5E-12	64.1E-12
Sigma	5.8E-12	4.1E-12	33.7E-12	5.3E-12	3.3E-12	9.2E-12	4.6E-12	2.2E-12	7.1E-12	6.1E-12	20.0E-12	5.0E-12	22.9E-12

**Drift Calculation**

IIH_A	0 kRad	10.8 kRad	20.7 kRad	55.6 kRad	102.6 kRad	155.7 kRad	212.4 kRad	268.2 kRad	326.7 kRad	374.2 kRad	416.7 kRad	24 Hours	168 Hours
OFF PROTON samples													
6	-	27.5E-12	61.6E-12	79.6E-12	131.6E-12	151.3E-12	157.3E-12	116.2E-12	185.1E-12	201.2E-12	152.7E-12	137.3E-12	80.8E-12
7	-	18.1E-12	128.1E-12	82.1E-12	114.7E-12	160.7E-12	159.0E-12	112.4E-12	192.8E-12	206.7E-12	155.2E-12	138.7E-12	21.4E-12
14	-	22.1E-12	57.2E-12	76.3E-12	115.9E-12	157.6E-12	150.8E-12	104.9E-12	182.5E-12	193.1E-12	185.8E-12	123.3E-12	20.0E-12
Average	-	22.6E-12	82.3E-12	79.3E-12	120.8E-12	156.5E-12	155.7E-12	111.1E-12	186.8E-12	200.3E-12	164.6E-12	133.1E-12	40.7E-12
Sigma	-	3.8E-12	32.5E-12	2.4E-12	7.7E-12	3.9E-12	3.5E-12	4.7E-12	4.4E-12	5.6E-12	15.0E-12	6.9E-12	28.3E-12

**Measurements**

IIH_A	0 kRad	10.8 kRad	20.7 kRad	55.6 kRad	102.6 kRad	155.7 kRad	212.4 kRad	268.2 kRad	326.7 kRad	374.2 kRad	416.7 kRad	24 Hours	168 Hours
1_REF	9.5E-12	14.0E-12	28.0E-12	15.4E-12	81.3E-12	14.2E-12	25.2E-12	14.8E-12	14.5E-12	19.6E-12	17.5E-12	19.9E-12	14.8E-12
OFF TID samples													
8	21.2E-12	41.4E-12	83.7E-12	102.7E-12	133.7E-12	177.1E-12	176.3E-12	130.9E-12	203.8E-12	207.1E-12	215.4E-12	153.9E-12	42.6E-12
9	21.9E-12	68.0E-12	79.3E-12	105.2E-12	126.8E-12	173.4E-12	178.1E-12	134.8E-12	212.1E-12	233.1E-12	172.0E-12	158.2E-12	40.8E-12
10	22.2E-12	32.5E-12	72.0E-12	94.0E-12	130.6E-12	172.0E-12	169.5E-12	125.1E-12	198.5E-12	207.1E-12	161.9E-12	146.7E-12	54.4E-12
Statistics													
Min	21.2E-12	32.5E-12	72.0E-12	94.0E-12	126.8E-12	172.0E-12	169.5E-12	125.1E-12	198.5E-12	207.1E-12	161.9E-12	146.7E-12	40.8E-12
Max	22.2E-12	68.0E-12	83.7E-12	105.2E-12	133.7E-12	177.1E-12	178.1E-12	134.8E-12	212.1E-12	233.1E-12	215.4E-12	158.2E-12	54.4E-12
Average	21.8E-12	47.3E-12	78.4E-12	100.6E-12	130.4E-12	174.2E-12	174.6E-12	130.3E-12	204.8E-12	215.8E-12	183.1E-12	153.0E-12	46.0E-12
Sigma	449.0E-15	15.1E-12	4.8E-12	4.8E-12	2.8E-12	2.1E-12	3.7E-12	4.0E-12	5.6E-12	12.3E-12	23.2E-12	4.7E-12	6.0E-12

**Drift Calculation**

IIH_A	0 kRad	10.8 kRad	20.7 kRad	55.6 kRad	102.6 kRad	155.7 kRad	212.4 kRad	268.2 kRad	326.7 kRad	374.2 kRad	416.7 kRad	24 Hours	168 Hours
OFF TID samples													
8	-	20.2E-12	62.6E-12	81.5E-12	112.5E-12	155.9E-12	155.1E-12	109.7E-12	182.6E-12	186.0E-12	194.2E-12	132.7E-12	21.5E-12
9	-	46.1E-12	57.4E-12	83.4E-12	105.0E-12	151.5E-12	156.2E-12	113.0E-12	190.2E-12	211.2E-12	150.1E-12	136.4E-12	18.9E-12
10	-	10.3E-12	49.8E-12	71.7E-12	108.4E-12	149.7E-12	147.2E-12	102.8E-12	176.3E-12	184.9E-12	139.6E-12	124.5E-12	32.2E-12
Average	-	25.5E-12	56.6E-12	78.9E-12	108.6E-12	152.4E-12	152.8E-12	108.5E-12	183.0E-12	194.0E-12	161.3E-12	131.2E-12	24.2E-12
Sigma	-	15.1E-12	5.3E-12	5.1E-12	3.1E-12	2.6E-12	4.0E-12	4.2E-12	5.7E-12	12.2E-12	23.7E-12	5.0E-12	5.8E-12

Parameter : Input Current. High : IIH\_B

Test conditions : VS=18V

Unit : A

Spec Limit Min : -2.0E-06

Spec Limit Max : 2.0E-06

Spec limits are represented in bold lines on the graphic.

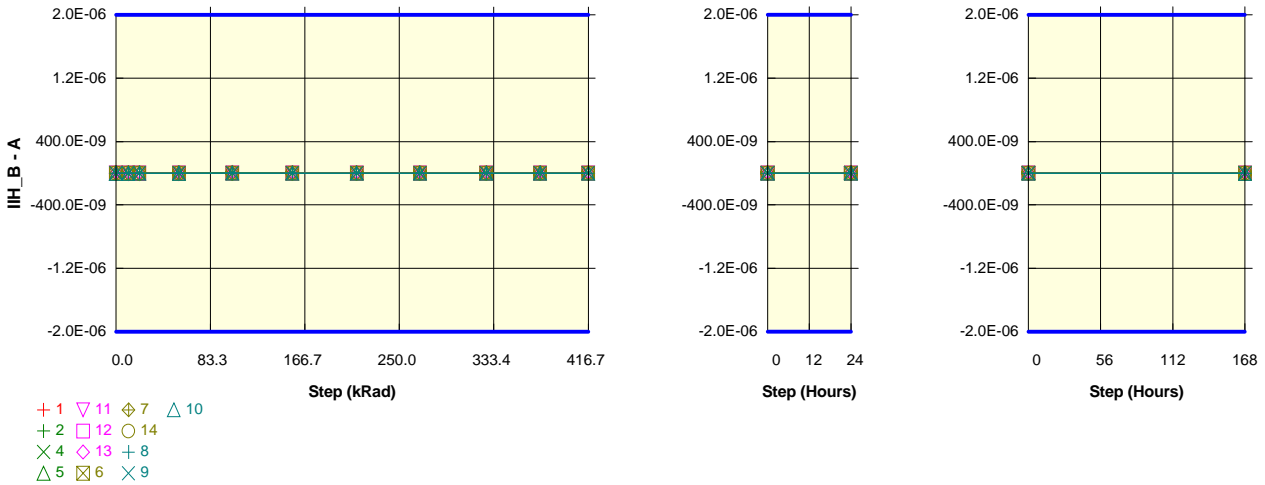

Measurements

IIH_B	0 kRad	10.8 kRad	20.7 kRad	55.6 kRad	102.6 kRad	155.7 kRad	212.4 kRad	268.2 kRad	326.7 kRad	374.2 kRad	416.7 kRad	24 Hours	168 Hours
1_REF	17.5E-12	19.9E-12	77.6E-12	17.7E-12	38.8E-12	24.3E-12	26.6E-12	18.3E-12	16.9E-12	25.2E-12	20.2E-12	13.1E-12	26.0E-12
ON PROTON samples													
2	24.8E-12	50.6E-12	67.2E-12	102.7E-12	8.3E-09	140.4E-12	161.2E-12	115.4E-12	174.4E-12	176.7E-12	134.5E-12	115.8E-12	43.2E-12
4	26.2E-12	60.4E-12	162.5E-12	106.3E-12	7.8E-09	136.4E-12	158.6E-12	112.4E-12	167.3E-12	172.8E-12	153.9E-12	120.5E-12	49.7E-12
5	27.8E-12	61.9E-12	181.8E-12	118.1E-12	7.6E-09	156.2E-12	175.4E-12	126.2E-12	189.2E-12	194.6E-12	152.5E-12	149.2E-12	47.8E-12
Statistics													
Min	24.8E-12	50.6E-12	67.2E-12	102.7E-12	7.6E-09	136.4E-12	158.6E-12	112.4E-12	167.3E-12	172.8E-12	134.5E-12	115.8E-12	43.2E-12
Max	27.8E-12	61.9E-12	181.8E-12	118.1E-12	8.3E-09	156.2E-12	175.4E-12	126.2E-12	189.2E-12	194.6E-12	153.9E-12	149.2E-12	49.7E-12
Average	26.3E-12	57.6E-12	137.2E-12	109.0E-12	7.9E-09	144.4E-12	165.1E-12	118.0E-12	177.0E-12	181.4E-12	147.0E-12	128.5E-12	46.9E-12
Sigma	1.2E-12	5.0E-12	50.1E-12	6.6E-12	284.7E-12	8.6E-12	7.4E-12	5.9E-12	9.1E-12	9.5E-12	8.8E-12	14.8E-12	2.8E-12

Drift Calculation

IIH_B	0 kRad	10.8 kRad	20.7 kRad	55.6 kRad	102.6 kRad	155.7 kRad	212.4 kRad	268.2 kRad	326.7 kRad	374.2 kRad	416.7 kRad	24 Hours	168 Hours
ON PROTON samples													
2	-	25.8E-12	42.4E-12	77.9E-12	8.3E-09	115.7E-12	136.4E-12	90.6E-12	149.6E-12	151.9E-12	109.7E-12	91.0E-12	18.4E-12
4	-	34.2E-12	136.3E-12	80.1E-12	7.8E-09	110.2E-12	132.4E-12	86.2E-12	141.1E-12	146.6E-12	127.7E-12	94.3E-12	23.5E-12
5	-	34.0E-12	153.9E-12	90.2E-12	7.6E-09	128.4E-12	147.6E-12	98.4E-12	161.4E-12	166.8E-12	124.7E-12	121.4E-12	19.9E-12
Average	-	31.3E-12	110.9E-12	82.7E-12	7.9E-09	118.1E-12	138.8E-12	91.7E-12	150.7E-12	155.1E-12	120.7E-12	102.2E-12	20.6E-12
Sigma	-	3.9E-12	49.0E-12	5.4E-12	285.9E-12	7.6E-12	6.4E-12	5.0E-12	8.3E-12	8.5E-12	7.8E-12	13.6E-12	2.2E-12

Measurements

IIH_B	0 kRad	10.8 kRad	20.7 kRad	55.6 kRad	102.6 kRad	155.7 kRad	212.4 kRad	268.2 kRad	326.7 kRad	374.2 kRad	416.7 kRad	24 Hours	168 Hours
1_REF	17.5E-12	19.9E-12	77.6E-12	17.7E-12	38.8E-12	24.3E-12	26.6E-12	18.3E-12	16.9E-12	25.2E-12	20.2E-12	13.1E-12	26.0E-12
ON TID samples													
11	19.6E-12	49.1E-12	90.7E-12	101.2E-12	488.3E-12	150.9E-12	164.4E-12	121.1E-12	179.0E-12	185.2E-12	144.3E-12	123.3E-12	55.4E-12
12	18.4E-12	45.7E-12	66.0E-12	104.3E-12	155.1E-12	152.5E-12	172.2E-12	127.8E-12	188.3E-12	188.3E-12	144.8E-12	133.0E-12	52.4E-12
13	18.0E-12	50.4E-12	62.3E-12	101.3E-12	7.0E-09	142.5E-12	166.2E-12	123.4E-12	182.4E-12	182.6E-12	154.6E-12	131.9E-12	48.8E-12
Statistics													
Min	18.0E-12	45.7E-12	62.3E-12	101.2E-12	155.1E-12	142.5E-12	164.4E-12	121.1E-12	179.0E-12	182.6E-12	144.3E-12	123.3E-12	48.8E-12
Max	19.6E-12	50.4E-12	90.7E-12	104.3E-12	7.0E-09	152.5E-12	172.2E-12	127.8E-12	188.3E-12	188.3E-12	154.6E-12	133.0E-12	55.4E-12
Average	18.7E-12	48.4E-12	73.0E-12	102.3E-12	2.6E-09	148.6E-12	167.6E-12	124.1E-12	183.2E-12	185.4E-12	147.9E-12	129.4E-12	52.2E-12
Sigma	676.1E-15	2.0E-12	12.6E-12	1.4E-12	3.2E-09	4.4E-12	3.3E-12	2.8E-12	3.8E-12	2.3E-12	4.8E-12	4.3E-12	2.7E-12

Drift Calculation

IIH_B	0 kRad	10.8 kRad	20.7 kRad	55.6 kRad	102.6 kRad	155.7 kRad	212.4 kRad	268.2 kRad	326.7 kRad	374.2 kRad	416.7 kRad	24 Hours	168 Hours
ON TID samples													
11	-	29.5E-12	71.1E-12	81.6E-12	468.7E-12	131.3E-12	144.8E-12	101.5E-12	159.4E-12	165.6E-12	124.7E-12	103.7E-12	35.8E-12
12	-	27.3E-12	47.6E-12	85.9E-12	136.7E-12	134.1E-12	153.8E-12	109.4E-12	169.9E-12	169.9E-12	126.4E-12	114.7E-12	34.1E-12
13	-	32.3E-12	44.3E-12	83.3E-12	7.0E-09	124.5E-12	148.2E-12	105.3E-12	164.4E-12	164.6E-12	136.6E-12	113.9E-12	30.7E-12
Average	-	29.7E-12	54.3E-12	83.6E-12	2.5E-09	130.0E-12	148.9E-12	105.4E-12	164.6E-12	166.7E-12	129.2E-12	110.8E-12	33.5E-12
Sigma	-	2.1E-12	11.9E-12	1.8E-12	3.2E-09	4.0E-12	3.7E-12	3.2E-12	4.3E-12	2.3E-12	5.3E-12	5.0E-12	2.1E-12

Hirex Engineering	Total Dose Radiation Test Report										Ref.:	HRX/TID/1013
	HS-4424BRH					Intersil					Issue:	01

**Measurements**

IIH_B	0 kRad	10.8 kRad	20.7 kRad	55.6 kRad	102.6 kRad	155.7 kRad	212.4 kRad	268.2 kRad	326.7 kRad	374.2 kRad	416.7 kRad	24 Hours	168 Hours
1_REF	17.5E-12	19.9E-12	77.6E-12	17.7E-12	38.8E-12	24.3E-12	26.6E-12	18.3E-12	16.9E-12	25.2E-12	20.2E-12	13.1E-12	26.0E-12
OFF PROTON samples													
6	23.7E-12	44.2E-12	137.8E-12	97.6E-12	387.4E-12	168.6E-12	173.7E-12	133.1E-12	202.9E-12	218.8E-12	172.7E-12	154.3E-12	60.9E-12
7	23.4E-12	44.4E-12	70.9E-12	113.2E-12	135.2E-12	184.4E-12	184.8E-12	141.8E-12	217.2E-12	227.4E-12	179.5E-12	159.5E-12	44.9E-12
14	26.8E-12	-8.6E-12	66.8E-12	104.3E-12	2.9E-09	182.1E-12	179.2E-12	138.0E-12	210.0E-12	221.9E-12	211.3E-12	161.9E-12	54.9E-12
Statistics													
Min	23.4E-12	-8.6E-12	66.8E-12	97.6E-12	135.2E-12	168.6E-12	173.7E-12	133.1E-12	202.9E-12	218.8E-12	172.7E-12	154.3E-12	44.9E-12
Max	26.8E-12	44.4E-12	137.8E-12	113.2E-12	2.9E-09	184.4E-12	184.8E-12	141.8E-12	217.2E-12	227.4E-12	211.3E-12	161.9E-12	60.9E-12
Average	24.6E-12	26.7E-12	91.8E-12	105.1E-12	1.1E-09	178.4E-12	179.2E-12	137.6E-12	210.1E-12	222.7E-12	187.8E-12	158.6E-12	53.6E-12
Sigma	1.5E-12	24.9E-12	32.6E-12	6.4E-12	1.3E-09	6.9E-12	4.5E-12	3.6E-12	5.8E-12	3.6E-12	16.8E-12	3.2E-12	6.6E-12

**Drift Calculation**

IIH_B	0 kRad	10.8 kRad	20.7 kRad	55.6 kRad	102.6 kRad	155.7 kRad	212.4 kRad	268.2 kRad	326.7 kRad	374.2 kRad	416.7 kRad	24 Hours	168 Hours
OFF PROTON samples													
6	-	20.5E-12	114.1E-12	73.9E-12	363.7E-12	144.9E-12	150.0E-12	109.4E-12	179.2E-12	195.0E-12	149.0E-12	130.6E-12	37.2E-12
7	-	20.9E-12	47.4E-12	89.8E-12	111.8E-12	160.9E-12	161.3E-12	118.4E-12	193.8E-12	204.0E-12	156.1E-12	136.1E-12	21.5E-12
14	-	-35.3E-12	40.0E-12	77.6E-12	2.9E-09	155.3E-12	152.4E-12	111.2E-12	183.2E-12	195.1E-12	184.6E-12	135.1E-12	28.1E-12
Average	-	2.0E-12	67.2E-12	80.4E-12	1.1E-09	153.7E-12	154.6E-12	113.0E-12	185.4E-12	198.0E-12	163.2E-12	133.9E-12	28.9E-12
Sigma	-	26.4E-12	33.3E-12	6.8E-12	1.3E-09	6.6E-12	4.9E-12	3.9E-12	6.1E-12	4.2E-12	15.4E-12	2.4E-12	6.5E-12

**Measurements**

IIH_B	0 kRad	10.8 kRad	20.7 kRad	55.6 kRad	102.6 kRad	155.7 kRad	212.4 kRad	268.2 kRad	326.7 kRad	374.2 kRad	416.7 kRad	24 Hours	168 Hours
1_REF	17.5E-12	19.9E-12	77.6E-12	17.7E-12	38.8E-12	24.3E-12	26.6E-12	18.3E-12	16.9E-12	25.2E-12	20.2E-12	13.1E-12	26.0E-12
OFF TID samples													
8	19.9E-12	-158.7E-12	66.5E-12	107.0E-12	394.5E-12	182.8E-12	181.0E-12	137.1E-12	210.5E-12	213.7E-12	218.6E-12	151.8E-12	66.4E-12
9	16.0E-12	69.4E-12	54.0E-12	106.6E-12	125.0E-12	177.4E-12	179.3E-12	138.4E-12	212.4E-12	235.1E-12	170.8E-12	153.6E-12	47.4E-12
10	17.1E-12	37.8E-12	212.9E-12	97.9E-12	2.7E-09	171.0E-12	173.8E-12	134.5E-12	200.5E-12	212.7E-12	161.6E-12	134.9E-12	48.0E-12
Statistics													
Min	16.0E-12	-158.7E-12	54.0E-12	97.9E-12	125.0E-12	171.0E-12	173.8E-12	134.5E-12	200.5E-12	212.7E-12	161.6E-12	134.9E-12	47.4E-12
Max	19.9E-12	69.4E-12	212.9E-12	107.0E-12	2.7E-09	182.8E-12	181.0E-12	138.4E-12	212.4E-12	235.1E-12	218.6E-12	153.6E-12	66.4E-12
Average	17.6E-12	-17.2E-12	111.1E-12	103.8E-12	1.1E-09	177.1E-12	178.0E-12	136.7E-12	207.8E-12	220.5E-12	183.7E-12	146.8E-12	53.9E-12
Sigma	1.6E-12	100.9E-12	72.2E-12	4.2E-12	1.1E-09	4.8E-12	3.1E-12	1.6E-12	5.2E-12	10.3E-12	25.0E-12	8.4E-12	8.8E-12

**Drift Calculation**

IIH_B	0 kRad	10.8 kRad	20.7 kRad	55.6 kRad	102.6 kRad	155.7 kRad	212.4 kRad	268.2 kRad	326.7 kRad	374.2 kRad	416.7 kRad	24 Hours	168 Hours
OFF TID samples													
8	-	-178.6E-12	46.6E-12	87.1E-12	374.6E-12	163.0E-12	161.1E-12	117.2E-12	190.6E-12	193.8E-12	198.8E-12	131.9E-12	46.6E-12
9	-	53.4E-12	38.0E-12	90.6E-12	109.0E-12	161.4E-12	163.3E-12	122.4E-12	196.5E-12	219.1E-12	154.8E-12	137.6E-12	31.4E-12
10	-	20.8E-12	195.9E-12	80.8E-12	2.7E-09	154.0E-12	156.7E-12	117.4E-12	183.4E-12	195.7E-12	144.5E-12	117.9E-12	30.9E-12
Average	-	-34.8E-12	93.5E-12	86.2E-12	1.1E-09	159.5E-12	160.4E-12	119.0E-12	190.2E-12	202.9E-12	166.0E-12	129.1E-12	36.3E-12
Sigma	-	102.5E-12	72.5E-12	4.1E-12	1.1E-09	3.9E-12	2.7E-12	2.4E-12	5.3E-12	11.5E-12	23.5E-12	8.3E-12	7.3E-12

Hirex Engineering	Total Dose Radiation Test Report			Ref.:	HRX/TID/1013
	HS-4424BRH	Intersil		Issue:	01

Parameter : Voltage Output : VOL\_A  
 Test conditions : VS=12V  
 Unit : V  
 Spec Limit Max : 800.0E-03  
 Spec limits are represented in bold lines on the graphic.

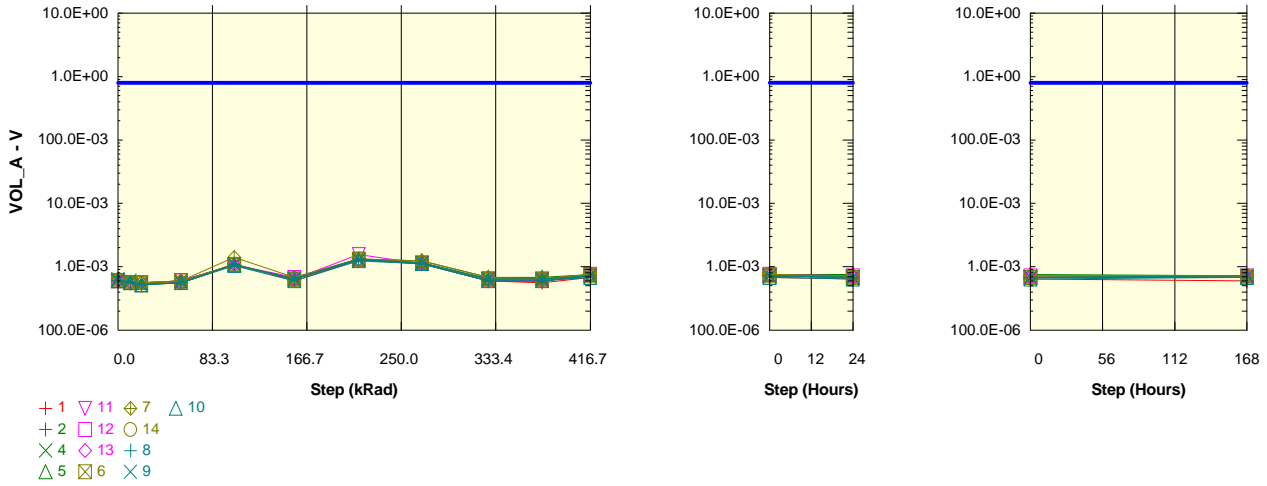

Measurements

VOL_A	0 kRad	10.8 kRad	20.7 kRad	55.6 kRad	102.6 kRad	155.7 kRad	212.4 kRad	268.2 kRad	326.7 kRad	374.2 kRad	416.7 kRad	24 Hours	168 Hours
1_REF	600.0E-06	560.0E-06	560.0E-06	560.0E-06	1.1E-03	600.0E-06	1.3E-03	1.2E-03	600.0E-06	560.0E-06	680.0E-06	640.0E-06	600.0E-06
ON_PROTON samples													
2	600.0E-06	560.0E-06	560.0E-06	560.0E-06	1.1E-03	640.0E-06	1.3E-03	1.2E-03	640.0E-06	600.0E-06	720.0E-06	680.0E-06	680.0E-06
4	640.0E-06	560.0E-06	560.0E-06	600.0E-06	1.1E-03	640.0E-06	1.3E-03	1.1E-03	600.0E-06	600.0E-06	720.0E-06	680.0E-06	680.0E-06
5	600.0E-06	560.0E-06	520.0E-06	600.0E-06	1.1E-03	640.0E-06	1.3E-03	1.2E-03	680.0E-06	680.0E-06	760.0E-06	760.0E-06	720.0E-06
Statistics													
Min	600.0E-06	560.0E-06	520.0E-06	560.0E-06	1.1E-03	640.0E-06	1.3E-03	1.1E-03	600.0E-06	600.0E-06	720.0E-06	680.0E-06	680.0E-06
Max	640.0E-06	560.0E-06	560.0E-06	600.0E-06	1.1E-03	640.0E-06	1.3E-03	1.2E-03	680.0E-06	680.0E-06	760.0E-06	760.0E-06	720.0E-06
Average	613.3E-06	560.0E-06	546.7E-06	586.7E-06	1.1E-03	640.0E-06	1.3E-03	1.2E-03	640.0E-06	626.7E-06	733.3E-06	706.7E-06	693.3E-06
Sigma	18.9E-06	4.2E-12	18.9E-06	18.9E-06	0.0E+00	4.2E-12	18.9E-06	49.9E-06	32.7E-06	37.7E-06	18.9E-06	37.7E-06	18.9E-06

Drift Calculation

VOL_A	0 kRad	10.8 kRad	20.7 kRad	55.6 kRad	102.6 kRad	155.7 kRad	212.4 kRad	268.2 kRad	326.7 kRad	374.2 kRad	416.7 kRad	24 Hours	168 Hours
ON_PROTON samples													
2	-	-40.0E-06	-40.0E-06	-40.0E-06	480.0E-06	40.0E-06	720.0E-06	560.0E-06	40.0E-06	0.0E+00	120.0E-06	80.0E-06	80.0E-06
4	-	-80.0E-06	-80.0E-06	-40.0E-06	440.0E-06	0.0E+00	640.0E-06	480.0E-06	-40.0E-06	-40.0E-06	80.0E-06	40.0E-06	40.0E-06
5	-	-40.0E-06	-80.0E-06	0.0E+00	480.0E-06	40.0E-06	720.0E-06	640.0E-06	80.0E-06	80.0E-06	160.0E-06	160.0E-06	120.0E-06
Average	-	-53.3E-06	-66.7E-06	-26.7E-06	466.7E-06	26.7E-06	693.3E-06	560.0E-06	26.7E-06	13.3E-06	120.0E-06	93.3E-06	80.0E-06
Sigma	-	18.9E-06	18.9E-06	18.9E-06	18.9E-06	18.9E-06	37.7E-06	65.3E-06	49.9E-06	49.9E-06	32.7E-06	49.9E-06	32.7E-06

Measurements

VOL_A	0 kRad	10.8 kRad	20.7 kRad	55.6 kRad	102.6 kRad	155.7 kRad	212.4 kRad	268.2 kRad	326.7 kRad	374.2 kRad	416.7 kRad	24 Hours	168 Hours
1_REF	600.0E-06	560.0E-06	560.0E-06	560.0E-06	1.1E-03	600.0E-06	1.3E-03	1.2E-03	600.0E-06	560.0E-06	680.0E-06	640.0E-06	600.0E-06
ON_TID samples													
11	600.0E-06	560.0E-06	560.0E-06	600.0E-06	1.1E-03	640.0E-06	1.6E-03	1.1E-03	640.0E-06	600.0E-06	720.0E-06	680.0E-06	680.0E-06
12	600.0E-06	560.0E-06	560.0E-06	600.0E-06	1.1E-03	680.0E-06	1.3E-03	1.2E-03	640.0E-06	640.0E-06	760.0E-06	720.0E-06	720.0E-06
13	600.0E-06	560.0E-06	560.0E-06	560.0E-06	1.1E-03	640.0E-06	1.3E-03	1.1E-03	600.0E-06	600.0E-06	720.0E-06	680.0E-06	680.0E-06
Statistics													
Min	600.0E-06	560.0E-06	560.0E-06	560.0E-06	1.1E-03	640.0E-06	1.3E-03	1.1E-03	600.0E-06	600.0E-06	720.0E-06	680.0E-06	680.0E-06
Max	600.0E-06	560.0E-06	560.0E-06	600.0E-06	1.1E-03	680.0E-06	1.6E-03	1.2E-03	640.0E-06	640.0E-06	760.0E-06	720.0E-06	720.0E-06
Average	600.0E-06	560.0E-06	560.0E-06	586.7E-06	1.1E-03	653.3E-06	1.4E-03	1.1E-03	626.7E-06	613.3E-06	733.3E-06	693.3E-06	693.3E-06
Sigma	4.2E-12	4.2E-12	4.2E-12	18.9E-06	0.0E+00	18.9E-06	123.6E-06	18.9E-06	18.9E-06	18.9E-06	18.9E-06	18.9E-06	18.9E-06

Drift Calculation

VOL_A	0 kRad	10.8 kRad	20.7 kRad	55.6 kRad	102.6 kRad	155.7 kRad	212.4 kRad	268.2 kRad	326.7 kRad	374.2 kRad	416.7 kRad	24 Hours	168 Hours
ON_TID samples													
11	-	-40.0E-06	-40.0E-06	0.0E+00	480.0E-06	40.0E-06	960.0E-06	520.0E-06	40.0E-06	0.0E+00	120.0E-06	80.0E-06	80.0E-06
12	-	-40.0E-06	-40.0E-06	0.0E+00	480.0E-06	80.0E-06	720.0E-06	560.0E-06	40.0E-06	40.0E-06	160.0E-06	120.0E-06	120.0E-06
13	-	-40.0E-06	-40.0E-06	-40.0E-06	480.0E-06	40.0E-06	680.0E-06	520.0E-06	0.0E+00	0.0E+00	120.0E-06	80.0E-06	80.0E-06
Average	-	-40.0E-06	-40.0E-06	-13.3E-06	480.0E-06	53.3E-06	786.7E-06	533.3E-06	26.7E-06	13.3E-06	133.3E-06	93.3E-06	93.3E-06
Sigma	-	0.0E+00	0.0E+00	18.9E-06	0.0E+00	18.9E-06	123.6E-06	18.9E-06	18.9E-06	18.9E-06	18.9E-06	18.9E-06	18.9E-06

Hirex Engineering	Total Dose Radiation Test Report									Ref.:	HRX/TID/1013		
	HS-4424BRH					Intersil				Issue:	01		

**Measurements**

VOL_A	0 kRad	10.8 kRad	20.7 kRad	55.6 kRad	102.6 kRad	155.7 kRad	212.4 kRad	268.2 kRad	326.7 kRad	374.2 kRad	416.7 kRad	24 Hours	168 Hours
1_REF	600.0E-06	560.0E-06	560.0E-06	560.0E-06	1.1E-03	600.0E-06	1.3E-03	1.2E-03	600.0E-06	560.0E-06	680.0E-06	640.0E-06	600.0E-06
OFF PROTON samples													
6	600.0E-06	560.0E-06	560.0E-06	600.0E-06	1.1E-03	640.0E-06	1.3E-03	1.1E-03	640.0E-06	640.0E-06	720.0E-06	680.0E-06	680.0E-06
7	640.0E-06	560.0E-06	560.0E-06	600.0E-06	1.4E-03	680.0E-06	1.3E-03	1.2E-03	680.0E-06	640.0E-06	760.0E-06	720.0E-06	720.0E-06
14	600.0E-06	560.0E-06	560.0E-06	560.0E-06	1.1E-03	640.0E-06	1.3E-03	1.2E-03	640.0E-06	640.0E-06	760.0E-06	680.0E-06	720.0E-06
Statistics													
Min	600.0E-06	560.0E-06	560.0E-06	560.0E-06	1.1E-03	640.0E-06	1.3E-03	1.1E-03	640.0E-06	640.0E-06	720.0E-06	680.0E-06	680.0E-06
Max	640.0E-06	560.0E-06	560.0E-06	600.0E-06	1.4E-03	680.0E-06	1.3E-03	1.2E-03	680.0E-06	640.0E-06	760.0E-06	720.0E-06	720.0E-06
Average	613.3E-06	560.0E-06	560.0E-06	586.7E-06	1.2E-03	653.3E-06	1.3E-03	1.2E-03	653.3E-06	640.0E-06	746.7E-06	693.3E-06	706.7E-06
Sigma	18.9E-06	4.2E-12	4.2E-12	18.9E-06	150.8E-06	18.9E-06	20.6E-12	49.9E-06	18.9E-06	4.2E-12	18.9E-06	18.9E-06	18.9E-06

**Drift Calculation**

VOL_A	0 kRad	10.8 kRad	20.7 kRad	55.6 kRad	102.6 kRad	155.7 kRad	212.4 kRad	268.2 kRad	326.7 kRad	374.2 kRad	416.7 kRad	24 Hours	168 Hours
OFF PROTON samples													
6	-	-40.0E-06	-40.0E-06	0.0E+00	480.0E-06	40.0E-06	720.0E-06	520.0E-06	40.0E-06	40.0E-06	120.0E-06	80.0E-06	80.0E-06
7	-	-80.0E-06	-80.0E-06	-40.0E-06	760.0E-06	40.0E-06	680.0E-06	600.0E-06	40.0E-06	0.0E+00	120.0E-06	80.0E-06	80.0E-06
14	-	-40.0E-06	-40.0E-06	-40.0E-06	480.0E-06	40.0E-06	720.0E-06	560.0E-06	40.0E-06	40.0E-06	160.0E-06	80.0E-06	120.0E-06
Average	-	-53.3E-06	-53.3E-06	-26.7E-06	573.3E-06	40.0E-06	706.7E-06	560.0E-06	40.0E-06	26.7E-06	133.3E-06	80.0E-06	93.3E-06
Sigma	-	18.9E-06	18.9E-06	18.9E-06	132.0E-06	27.4E-12	18.9E-06	32.7E-06	27.4E-12	18.9E-06	18.9E-06	27.5E-12	18.9E-06

**Measurements**

VOL_A	0 kRad	10.8 kRad	20.7 kRad	55.6 kRad	102.6 kRad	155.7 kRad	212.4 kRad	268.2 kRad	326.7 kRad	374.2 kRad	416.7 kRad	24 Hours	168 Hours
1_REF	600.0E-06	560.0E-06	560.0E-06	560.0E-06	1.1E-03	600.0E-06	1.3E-03	1.2E-03	600.0E-06	560.0E-06	680.0E-06	640.0E-06	600.0E-06
OFF TID samples													
8	600.0E-06	560.0E-06	520.0E-06	560.0E-06	1.1E-03	640.0E-06	1.3E-03	1.1E-03	600.0E-06	600.0E-06	720.0E-06	680.0E-06	680.0E-06
9	600.0E-06	600.0E-06	520.0E-06	560.0E-06	1.1E-03	640.0E-06	1.3E-03	1.2E-03	640.0E-06	640.0E-06	720.0E-06	680.0E-06	720.0E-06
10	600.0E-06	560.0E-06	520.0E-06	560.0E-06	1.0E-03	600.0E-06	1.2E-03	1.1E-03	600.0E-06	600.0E-06	680.0E-06	640.0E-06	680.0E-06
Statistics													
Min	600.0E-06	560.0E-06	520.0E-06	560.0E-06	1.0E-03	600.0E-06	1.2E-03	1.1E-03	600.0E-06	600.0E-06	680.0E-06	640.0E-06	680.0E-06
Max	600.0E-06	600.0E-06	520.0E-06	560.0E-06	1.1E-03	640.0E-06	1.3E-03	1.2E-03	640.0E-06	640.0E-06	720.0E-06	680.0E-06	720.0E-06
Average	600.0E-06	573.3E-06	520.0E-06	560.0E-06	1.1E-03	626.7E-06	1.3E-03	1.1E-03	613.3E-06	613.3E-06	706.7E-06	666.7E-06	693.3E-06
Sigma	4.2E-12	18.9E-06	0.0E+00	4.2E-12	18.9E-06	18.9E-06	32.7E-06	18.9E-06	18.9E-06	18.9E-06	18.9E-06	18.9E-06	18.9E-06

**Drift Calculation**

VOL_A	0 kRad	10.8 kRad	20.7 kRad	55.6 kRad	102.6 kRad	155.7 kRad	212.4 kRad	268.2 kRad	326.7 kRad	374.2 kRad	416.7 kRad	24 Hours	168 Hours
OFF TID samples													
8	-	-40.0E-06	-80.0E-06	-40.0E-06	480.0E-06	40.0E-06	720.0E-06	520.0E-06	0.0E+00	0.0E+00	120.0E-06	80.0E-06	80.0E-06
9	-	0.0E+00	-80.0E-06	-40.0E-06	480.0E-06	40.0E-06	680.0E-06	560.0E-06	40.0E-06	40.0E-06	120.0E-06	80.0E-06	120.0E-06
10	-	-40.0E-06	-80.0E-06	-40.0E-06	440.0E-06	0.0E+00	640.0E-06	520.0E-06	0.0E+00	0.0E+00	80.0E-06	40.0E-06	80.0E-06
Average	-	-26.7E-06	-80.0E-06	-40.0E-06	466.7E-06	26.7E-06	680.0E-06	533.3E-06	13.3E-06	13.3E-06	106.7E-06	66.7E-06	93.3E-06
Sigma	-	18.9E-06	525.1E-15	0.0E+00	18.9E-06	18.9E-06	32.7E-06	18.9E-06	18.9E-06	18.9E-06	18.9E-06	18.9E-06	18.9E-06



Parameter : Voltage Output : VOL\_B

Test conditions : VS=12V

Unit : V

Spec Limit Max : 800.0E-03

Spec limits are represented in bold lines on the graphic.

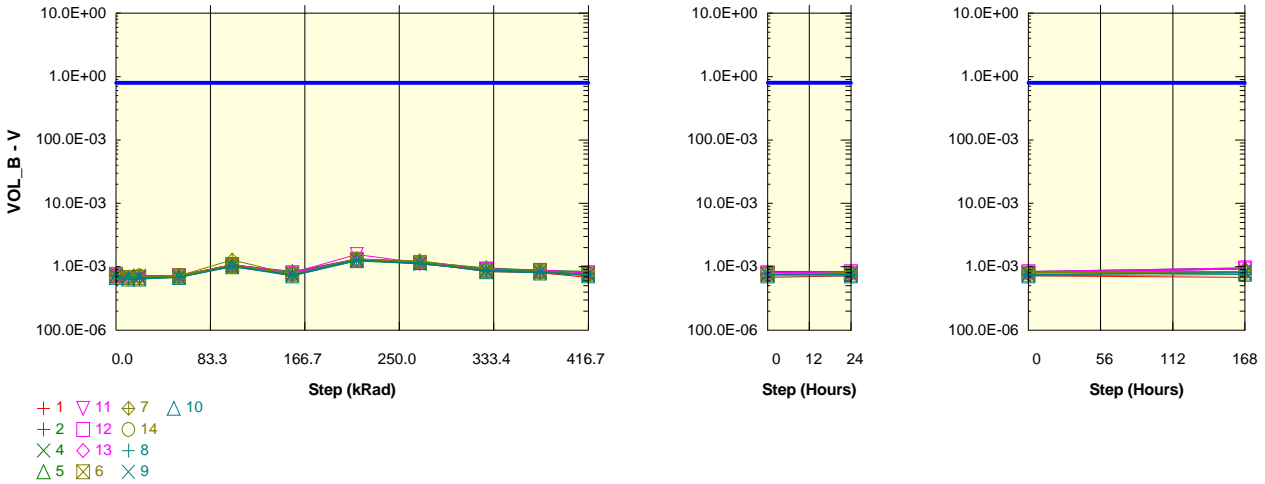

Measurements

VOL_B	0 kRad	10.8 kRad	20.7 kRad	55.6 kRad	102.6 kRad	155.7 kRad	212.4 kRad	268.2 kRad	326.7 kRad	374.2 kRad	416.7 kRad	24 Hours	168 Hours
1_REF	720.0E-06	680.0E-06	680.0E-06	720.0E-06	1.1E-03	720.0E-06	1.3E-03	1.2E-03	840.0E-06	800.0E-06	680.0E-06	720.0E-06	680.0E-06
ON_PROTON samples													
2	720.0E-06	680.0E-06	720.0E-06	720.0E-06	1.1E-03	800.0E-06	1.3E-03	1.2E-03	920.0E-06	880.0E-06	800.0E-06	800.0E-06	920.0E-06
4	720.0E-06	680.0E-06	720.0E-06	720.0E-06	1.1E-03	760.0E-06	1.2E-03	1.1E-03	880.0E-06	840.0E-06	760.0E-06	800.0E-06	840.0E-06
5	720.0E-06	680.0E-06	680.0E-06	720.0E-06	1.1E-03	840.0E-06	1.3E-03	1.2E-03	960.0E-06	880.0E-06	840.0E-06	840.0E-06	960.0E-06
Statistics													
Min	720.0E-06	680.0E-06	680.0E-06	720.0E-06	1.1E-03	760.0E-06	1.2E-03	1.1E-03	880.0E-06	840.0E-06	760.0E-06	800.0E-06	840.0E-06
Max	720.0E-06	680.0E-06	720.0E-06	720.0E-06	1.1E-03	840.0E-06	1.3E-03	1.2E-03	960.0E-06	880.0E-06	840.0E-06	840.0E-06	960.0E-06
Average	720.0E-06	680.0E-06	706.7E-06	720.0E-06	1.1E-03	800.0E-06	1.3E-03	1.2E-03	920.0E-06	866.7E-06	800.0E-06	813.3E-06	906.7E-06
Sigma	0.0E+00	0.0E+00	18.9E-06	0.0E+00	0.0E+00	32.7E-06	37.7E-06	37.7E-06	32.7E-06	18.9E-06	32.7E-06	18.9E-06	49.9E-06

Drift Calculation

VOL_B	0 kRad	10.8 kRad	20.7 kRad	55.6 kRad	102.6 kRad	155.7 kRad	212.4 kRad	268.2 kRad	326.7 kRad	374.2 kRad	416.7 kRad	24 Hours	168 Hours
ON_PROTON samples													
2	-	-40.0E-06	0.0E+00	0.0E+00	360.0E-06	80.0E-06	600.0E-06	480.0E-06	200.0E-06	160.0E-06	80.0E-06	80.0E-06	200.0E-06
4	-	-40.0E-06	0.0E+00	0.0E+00	360.0E-06	40.0E-06	520.0E-06	400.0E-06	160.0E-06	120.0E-06	40.0E-06	80.0E-06	120.0E-06
5	-	-40.0E-06	-40.0E-06	0.0E+00	360.0E-06	120.0E-06	600.0E-06	480.0E-06	240.0E-06	160.0E-06	120.0E-06	120.0E-06	240.0E-06
Average	-	-40.0E-06	-13.3E-06	0.0E+00	360.0E-06	80.0E-06	573.3E-06	453.3E-06	200.0E-06	146.7E-06	80.0E-06	93.3E-06	186.7E-06
Sigma	-	371.3E-15	18.9E-06	0.0E+00	0.0E+00	32.7E-06	37.7E-06	37.7E-06	32.7E-06	18.9E-06	32.7E-06	18.9E-06	49.9E-06

Measurements

VOL_B	0 kRad	10.8 kRad	20.7 kRad	55.6 kRad	102.6 kRad	155.7 kRad	212.4 kRad	268.2 kRad	326.7 kRad	374.2 kRad	416.7 kRad	24 Hours	168 Hours
1_REF	720.0E-06	680.0E-06	680.0E-06	720.0E-06	1.1E-03	720.0E-06	1.3E-03	1.2E-03	840.0E-06	800.0E-06	680.0E-06	720.0E-06	680.0E-06
ON_TID samples													
11	720.0E-06	680.0E-06	680.0E-06	720.0E-06	1.1E-03	800.0E-06	1.6E-03	1.2E-03	920.0E-06	880.0E-06	800.0E-06	800.0E-06	920.0E-06
12	720.0E-06	680.0E-06	680.0E-06	720.0E-06	1.1E-03	800.0E-06	1.3E-03	1.2E-03	920.0E-06	880.0E-06	800.0E-06	840.0E-06	960.0E-06
13	720.0E-06	680.0E-06	720.0E-06	720.0E-06	1.1E-03	800.0E-06	1.3E-03	1.2E-03	920.0E-06	840.0E-06	760.0E-06	800.0E-06	920.0E-06
Statistics													
Min	720.0E-06	680.0E-06	680.0E-06	720.0E-06	1.1E-03	800.0E-06	1.3E-03	1.2E-03	920.0E-06	840.0E-06	760.0E-06	800.0E-06	920.0E-06
Max	720.0E-06	680.0E-06	720.0E-06	720.0E-06	1.1E-03	800.0E-06	1.6E-03	1.2E-03	920.0E-06	880.0E-06	800.0E-06	840.0E-06	960.0E-06
Average	720.0E-06	680.0E-06	693.3E-06	720.0E-06	1.1E-03	800.0E-06	1.4E-03	1.2E-03	920.0E-06	866.7E-06	786.7E-06	813.3E-06	933.3E-06
Sigma	0.0E+00	0.0E+00	18.9E-06	0.0E+00	0.0E+00	8.4E-12	123.6E-06	8.4E-12	14.6E-12	18.9E-06	18.9E-06	18.9E-06	18.9E-06

Drift Calculation

VOL_B	0 kRad	10.8 kRad	20.7 kRad	55.6 kRad	102.6 kRad	155.7 kRad	212.4 kRad	268.2 kRad	326.7 kRad	374.2 kRad	416.7 kRad	24 Hours	168 Hours
ON_TID samples													
11	-	-40.0E-06	-40.0E-06	0.0E+00	360.0E-06	80.0E-06	840.0E-06	440.0E-06	200.0E-06	160.0E-06	80.0E-06	80.0E-06	200.0E-06
12	-	-40.0E-06	-40.0E-06	0.0E+00	360.0E-06	80.0E-06	600.0E-06	440.0E-06	200.0E-06	160.0E-06	80.0E-06	120.0E-06	240.0E-06
13	-	-40.0E-06	0.0E+00	0.0E+00	360.0E-06	80.0E-06	560.0E-06	440.0E-06	200.0E-06	120.0E-06	40.0E-06	80.0E-06	200.0E-06
Average	-	-40.0E-06	-26.7E-06	0.0E+00	360.0E-06	80.0E-06	666.7E-06	440.0E-06	200.0E-06	146.7E-06	66.7E-06	93.3E-06	213.3E-06
Sigma	-	371.3E-15	18.9E-06	0.0E+00	0.0E+00	525.1E-15	123.6E-06	3.0E-12	1.5E-12	18.9E-06	18.9E-06	18.9E-06	18.9E-06

Hirex Engineering	Total Dose Radiation Test Report									Ref.:	HRX/TID/1013	
	HS-4424BRH				Intersil					Issue:	01	

**Measurements**

VOL_B	0 kRad	10.8 kRad	20.7 kRad	55.6 kRad	102.6 kRad	155.7 kRad	212.4 kRad	268.2 kRad	326.7 kRad	374.2 kRad	416.7 kRad	24 Hours	168 Hours
1_REF	720.0E-06	680.0E-06	680.0E-06	720.0E-06	1.1E-03	720.0E-06	1.3E-03	1.2E-03	840.0E-06	800.0E-06	680.0E-06	720.0E-06	680.0E-06
OFF PROTON samples													
6	760.0E-06	680.0E-06	680.0E-06	720.0E-06	1.0E-03	760.0E-06	1.3E-03	1.2E-03	880.0E-06	840.0E-06	760.0E-06	760.0E-06	800.0E-06
7	760.0E-06	680.0E-06	680.0E-06	720.0E-06	1.3E-03	760.0E-06	1.3E-03	1.2E-03	920.0E-06	840.0E-06	760.0E-06	800.0E-06	840.0E-06
14	720.0E-06	680.0E-06	720.0E-06	720.0E-06	1.1E-03	760.0E-06	1.3E-03	1.2E-03	880.0E-06	840.0E-06	760.0E-06	800.0E-06	840.0E-06
Statistics													
Min	720.0E-06	680.0E-06	680.0E-06	720.0E-06	1.0E-03	760.0E-06	1.3E-03	1.2E-03	880.0E-06	840.0E-06	760.0E-06	760.0E-06	800.0E-06
Max	760.0E-06	680.0E-06	720.0E-06	720.0E-06	1.3E-03	760.0E-06	1.3E-03	1.2E-03	920.0E-06	840.0E-06	760.0E-06	800.0E-06	840.0E-06
Average	746.7E-06	680.0E-06	693.3E-06	720.0E-06	1.1E-03	760.0E-06	1.3E-03	1.2E-03	893.3E-06	840.0E-06	760.0E-06	786.7E-06	826.7E-06
Sigma	18.9E-06	0.0E+00	18.9E-06	0.0E+00	105.0E-06	13.3E-12	18.9E-06	37.7E-06	18.9E-06	5.9E-12	13.3E-12	18.9E-06	18.9E-06

**Drift Calculation**

VOL_B	0 kRad	10.8 kRad	20.7 kRad	55.6 kRad	102.6 kRad	155.7 kRad	212.4 kRad	268.2 kRad	326.7 kRad	374.2 kRad	416.7 kRad	24 Hours	168 Hours
OFF PROTON samples													
6	-	-80.0E-06	-80.0E-06	-40.0E-06	280.0E-06	0.0E+00	520.0E-06	400.0E-06	120.0E-06	80.0E-06	0.0E+00	0.0E+00	40.0E-06
7	-	-80.0E-06	-80.0E-06	-40.0E-06	520.0E-06	0.0E+00	560.0E-06	480.0E-06	160.0E-06	80.0E-06	0.0E+00	40.0E-06	80.0E-06
14	-	-40.0E-06	0.0E+00	0.0E+00	360.0E-06	40.0E-06	600.0E-06	440.0E-06	160.0E-06	120.0E-06	40.0E-06	80.0E-06	120.0E-06
Average	-	-66.7E-06	-53.3E-06	-26.7E-06	386.7E-06	13.3E-06	560.0E-06	440.0E-06	146.7E-06	93.3E-06	13.3E-06	40.0E-06	80.0E-06
Sigma	-	18.9E-06	37.7E-06	18.9E-06	99.8E-06	18.9E-06	32.7E-06	32.7E-06	18.9E-06	18.9E-06	18.9E-06	32.7E-06	32.7E-06

**Measurements**

VOL_B	0 kRad	10.8 kRad	20.7 kRad	55.6 kRad	102.6 kRad	155.7 kRad	212.4 kRad	268.2 kRad	326.7 kRad	374.2 kRad	416.7 kRad	24 Hours	168 Hours
1_REF	720.0E-06	680.0E-06	680.0E-06	720.0E-06	1.1E-03	720.0E-06	1.3E-03	1.2E-03	840.0E-06	800.0E-06	680.0E-06	720.0E-06	680.0E-06
OFF TID samples													
8	720.0E-06	640.0E-06	640.0E-06	680.0E-06	1.0E-03	720.0E-06	1.3E-03	1.1E-03	880.0E-06	800.0E-06	760.0E-06	760.0E-06	800.0E-06
9	720.0E-06	720.0E-06	680.0E-06	680.0E-06	1.0E-03	760.0E-06	1.3E-03	1.1E-03	880.0E-06	840.0E-06	760.0E-06	760.0E-06	800.0E-06
10	680.0E-06	640.0E-06	640.0E-06	680.0E-06	1.0E-03	720.0E-06	1.2E-03	1.2E-03	840.0E-06	800.0E-06	720.0E-06	720.0E-06	760.0E-06
Statistics													
Min	680.0E-06	640.0E-06	640.0E-06	680.0E-06	1.0E-03	720.0E-06	1.2E-03	1.1E-03	840.0E-06	800.0E-06	720.0E-06	720.0E-06	760.0E-06
Max	720.0E-06	720.0E-06	680.0E-06	680.0E-06	1.0E-03	760.0E-06	1.3E-03	1.2E-03	880.0E-06	840.0E-06	760.0E-06	760.0E-06	800.0E-06
Average	706.7E-06	666.7E-06	653.3E-06	680.0E-06	1.0E-03	733.3E-06	1.3E-03	1.1E-03	866.7E-06	813.3E-06	746.7E-06	746.7E-06	786.7E-06
Sigma	18.9E-06	37.7E-06	18.9E-06	0.0E+00	18.9E-06	18.9E-06	18.9E-06	18.9E-06	18.9E-06	18.9E-06	18.9E-06	18.9E-06	18.9E-06

**Drift Calculation**

VOL_B	0 kRad	10.8 kRad	20.7 kRad	55.6 kRad	102.6 kRad	155.7 kRad	212.4 kRad	268.2 kRad	326.7 kRad	374.2 kRad	416.7 kRad	24 Hours	168 Hours
OFF TID samples													
8	-	-80.0E-06	-80.0E-06	-40.0E-06	320.0E-06	0.0E+00	560.0E-06	400.0E-06	160.0E-06	80.0E-06	40.0E-06	40.0E-06	80.0E-06
9	-	0.0E+00	-40.0E-06	-40.0E-06	280.0E-06	40.0E-06	560.0E-06	400.0E-06	160.0E-06	120.0E-06	40.0E-06	40.0E-06	80.0E-06
10	-	-40.0E-06	-40.0E-06	0.0E+00	320.0E-06	40.0E-06	560.0E-06	480.0E-06	160.0E-06	120.0E-06	40.0E-06	40.0E-06	80.0E-06
Average	-	-40.0E-06	-53.3E-06	-26.7E-06	306.7E-06	26.7E-06	560.0E-06	426.7E-06	160.0E-06	106.7E-06	40.0E-06	40.0E-06	80.0E-06
Sigma	-	32.7E-06	18.9E-06	18.9E-06	18.9E-06	18.9E-06	27.5E-12	37.7E-06	0.0E+00	18.9E-06	371.3E-15	371.3E-15	27.5E-12

Parameter : Voltage Output : VOH\_A

Test conditions : VS=12V

Unit : V

Spec Limit Min : 11.25

Spec limits are represented in bold lines on the graphic.

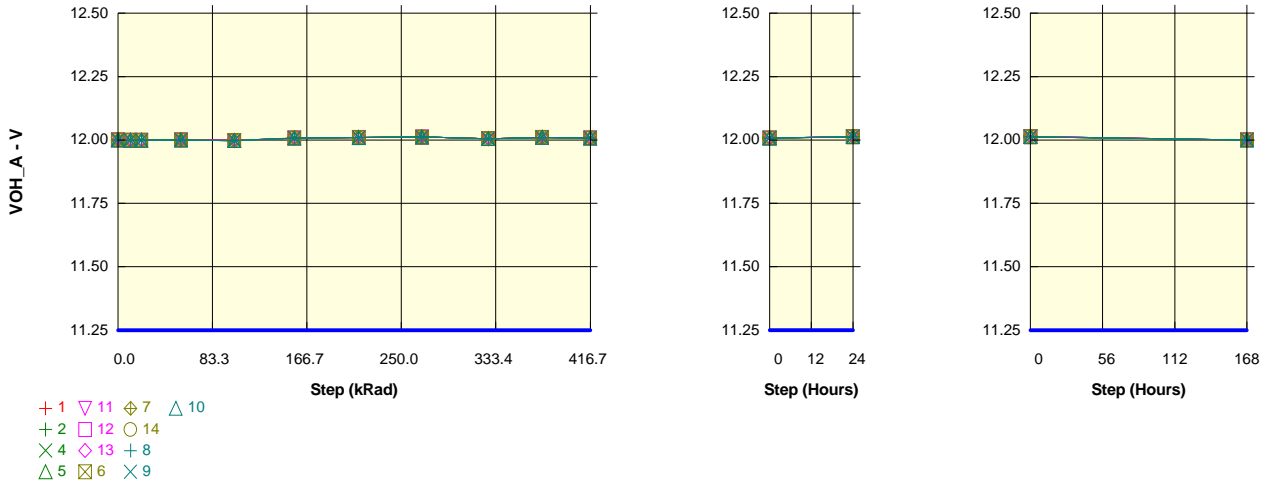

Measurements

VOH_A	0 kRad	10.8 kRad	20.7 kRad	55.6 kRad	102.6 kRad	155.7 kRad	212.4 kRad	268.2 kRad	326.7 kRad	374.2 kRad	416.7 kRad	24 Hours	168 Hours
1_REF	12.00	12.00	12.00	12.00	12.00	12.01	12.01	12.01	12.00	12.01	12.01	12.01	12.00
ON_PROTON samples													
2	12.00	12.00	12.00	12.00	12.00	12.01	12.01	12.01	12.00	12.01	12.01	12.01	12.00
4	12.00	12.00	12.00	12.00	12.00	12.01	12.01	12.01	12.00	12.01	12.01	12.01	12.00
5	12.00	12.00	12.00	12.00	12.00	12.01	12.01	12.01	12.00	12.01	12.01	12.01	12.00
Statistics													
Min	12.00	12.00	12.00	12.00	12.00	12.01	12.01	12.01	12.00	12.01	12.01	12.01	12.00
Max	12.00	12.00	12.00	12.00	12.00	12.01	12.01	12.01	12.00	12.01	12.01	12.01	12.00
Average	12.00	12.00	12.00	12.00	12.00	12.01	12.01	12.01	12.00	12.01	12.01	12.01	12.00
Sigma	0.00	0.00	0.00	0.00	0.00	0.00	0.00	0.00	0.00	0.00	0.00	0.00	0.00

Drift Calculation

VOH_A	0 kRad	10.8 kRad	20.7 kRad	55.6 kRad	102.6 kRad	155.7 kRad	212.4 kRad	268.2 kRad	326.7 kRad	374.2 kRad	416.7 kRad	24 Hours	168 Hours
ON_PROTON samples													
2	-	-1.2E-03	-400.5E-06	399.6E-06	-2.0E-03	8.0E-03	10.4E-03	12.0E-03	5.2E-03	10.4E-03	8.0E-03	13.6E-03	399.6E-06
4	-	-1.2E-03	-400.5E-06	399.6E-06	-2.0E-03	8.0E-03	10.4E-03	12.0E-03	5.2E-03	10.4E-03	8.0E-03	13.6E-03	399.6E-06
5	-	-1.2E-03	-400.5E-06	399.6E-06	-2.0E-03	8.0E-03	10.4E-03	12.0E-03	5.2E-03	10.4E-03	8.0E-03	13.6E-03	399.6E-06
Average	-	-1.2E-03	-400.5E-06	399.6E-06	-2.0E-03	8.0E-03	10.4E-03	12.0E-03	5.2E-03	10.4E-03	8.0E-03	13.6E-03	399.6E-06
Sigma	-	0.0E+00	0.0E+00	0.0E+00	0.0E+00	0.0E+00	67.2E-12	0.0E+00	0.0E+00	67.2E-12	0.0E+00	0.0E+00	0.0E+00

Measurements

VOH_A	0 kRad	10.8 kRad	20.7 kRad	55.6 kRad	102.6 kRad	155.7 kRad	212.4 kRad	268.2 kRad	326.7 kRad	374.2 kRad	416.7 kRad	24 Hours	168 Hours
1_REF	12.00	12.00	12.00	12.00	12.00	12.01	12.01	12.01	12.00	12.01	12.01	12.01	12.00
ON_TID samples													
11	12.00	12.00	12.00	12.00	12.00	12.01	12.01	12.01	12.00	12.01	12.01	12.01	12.00
12	12.00	12.00	12.00	12.00	12.00	12.01	12.01	12.01	12.00	12.01	12.01	12.01	12.00
13	12.00	12.00	12.00	12.00	12.00	12.01	12.01	12.01	12.00	12.01	12.01	12.01	12.00
Statistics													
Min	12.00	12.00	12.00	12.00	12.00	12.01	12.01	12.01	12.00	12.01	12.01	12.01	12.00
Max	12.00	12.00	12.00	12.00	12.00	12.01	12.01	12.01	12.00	12.01	12.01	12.01	12.00
Average	12.00	12.00	12.00	12.00	12.00	12.01	12.01	12.01	12.00	12.01	12.01	12.01	12.00
Sigma	0.00	0.00	0.00	0.00	0.00	0.00	0.00	0.00	0.00	0.00	0.00	0.00	0.00

Drift Calculation

VOH_A	0 kRad	10.8 kRad	20.7 kRad	55.6 kRad	102.6 kRad	155.7 kRad	212.4 kRad	268.2 kRad	326.7 kRad	374.2 kRad	416.7 kRad	24 Hours	168 Hours
ON_TID samples													
11	-	-800.1E-06	-400.5E-06	399.6E-06	-2.0E-03	8.0E-03	10.4E-03	12.0E-03	5.2E-03	10.4E-03	8.0E-03	13.6E-03	399.6E-06
12	-	-800.1E-06	-400.5E-06	399.6E-06	-2.0E-03	8.0E-03	10.4E-03	12.0E-03	5.2E-03	10.4E-03	8.0E-03	13.6E-03	399.6E-06
13	-	-800.1E-06	-400.5E-06	399.6E-06	-2.0E-03	8.0E-03	10.4E-03	12.0E-03	5.2E-03	10.4E-03	8.0E-03	13.6E-03	399.6E-06
Average	-	-800.1E-06	-400.5E-06	399.6E-06	-2.0E-03	8.0E-03	10.4E-03	12.0E-03	5.2E-03	10.4E-03	8.0E-03	13.6E-03	399.6E-06
Sigma	-	0.0E+00	0.0E+00	0.0E+00	0.0E+00	0.0E+00	67.2E-12	0.0E+00	0.0E+00	67.2E-12	0.0E+00	0.0E+00	0.0E+00

Hirex Engineering	Total Dose Radiation Test Report										Ref.:	HRX/TID/1013
	HS-4424BRH					Intersil					Issue:	01

**Measurements**

VOH_A	0 kRad	10.8 kRad	20.7 kRad	55.6 kRad	102.6 kRad	155.7 kRad	212.4 kRad	268.2 kRad	326.7 kRad	374.2 kRad	416.7 kRad	24 Hours	168 Hours
1_REF	12.00	12.00	12.00	12.00	12.00	12.01	12.01	12.01	12.00	12.01	12.01	12.01	12.00
OFF PROTON samples													
6	12.00	12.00	12.00	12.00	12.00	12.01	12.01	12.01	12.00	12.01	12.01	12.01	12.00
7	12.00	12.00	12.00	12.00	12.00	12.01	12.01	12.01	12.00	12.01	12.01	12.01	12.00
14	12.00	12.00	12.00	12.00	12.00	12.01	12.01	12.01	12.00	12.01	12.01	12.01	12.00
Statistics													
Min	12.00	12.00	12.00	12.00	12.00	12.01	12.01	12.01	12.00	12.01	12.01	12.01	12.00
Max	12.00	12.00	12.00	12.00	12.00	12.01	12.01	12.01	12.00	12.01	12.01	12.01	12.00
Average	12.00	12.00	12.00	12.00	12.00	12.01	12.01	12.01	12.00	12.01	12.01	12.01	12.00
Sigma	0.00	0.00	0.00	0.00	0.00	0.00	0.00	0.00	0.00	0.00	0.00	0.00	0.00

**Drift Calculation**

VOH_A	0 kRad	10.8 kRad	20.7 kRad	55.6 kRad	102.6 kRad	155.7 kRad	212.4 kRad	268.2 kRad	326.7 kRad	374.2 kRad	416.7 kRad	24 Hours	168 Hours
OFF PROTON samples													
6	-	-800.1E-06	-400.5E-06	399.6E-06	-2.4E-03	8.0E-03	10.0E-03	12.0E-03	5.2E-03	10.4E-03	8.0E-03	13.2E-03	399.6E-06
7	-	-2.0E-03	-400.5E-06	399.6E-06	-2.4E-03	8.0E-03	10.0E-03	12.0E-03	5.2E-03	10.4E-03	8.0E-03	13.2E-03	399.6E-06
14	-	-1.2E-03	-400.5E-06	399.6E-06	-2.4E-03	8.0E-03	10.0E-03	12.0E-03	5.2E-03	10.4E-03	8.0E-03	13.2E-03	399.6E-06
Average	-	-1.3E-03	-400.5E-06	399.6E-06	-2.4E-03	8.0E-03	10.0E-03	12.0E-03	5.2E-03	10.4E-03	8.0E-03	13.2E-03	399.6E-06
Sigma	-	499.1E-06	0.0E+00	0.0E+00	0.0E+00	0.0E+00	95.1E-12	0.0E+00	0.0E+00	67.2E-12	0.0E+00	95.1E-12	0.0E+00

**Measurements**

VOH_A	0 kRad	10.8 kRad	20.7 kRad	55.6 kRad	102.6 kRad	155.7 kRad	212.4 kRad	268.2 kRad	326.7 kRad	374.2 kRad	416.7 kRad	24 Hours	168 Hours
1_REF	12.00	12.00	12.00	12.00	12.00	12.01	12.01	12.01	12.00	12.01	12.01	12.01	12.00
OFF TID samples													
8	12.00	12.00	12.00	12.00	12.00	12.01	12.01	12.01	12.00	12.01	12.01	12.01	12.00
9	12.00	12.00	12.00	12.00	12.00	12.01	12.01	12.01	12.00	12.01	12.01	12.01	12.00
10	12.00	12.00	12.00	12.00	12.00	12.01	12.01	12.01	12.00	12.01	12.01	12.01	12.00
Statistics													
Min	12.00	12.00	12.00	12.00	12.00	12.01	12.01	12.01	12.00	12.01	12.01	12.01	12.00
Max	12.00	12.00	12.00	12.00	12.00	12.01	12.01	12.01	12.00	12.01	12.01	12.01	12.00
Average	12.00	12.00	12.00	12.00	12.00	12.01	12.01	12.01	12.00	12.01	12.01	12.01	12.00
Sigma	0.00	0.00	0.00	0.00	0.00	0.00	0.00	0.00	0.00	0.00	0.00	0.00	0.00

**Drift Calculation**

VOH_A	0 kRad	10.8 kRad	20.7 kRad	55.6 kRad	102.6 kRad	155.7 kRad	212.4 kRad	268.2 kRad	326.7 kRad	374.2 kRad	416.7 kRad	24 Hours	168 Hours
OFF TID samples													
8	-	-1.2E-03	-400.5E-06	399.6E-06	-2.4E-03	8.0E-03	10.0E-03	12.0E-03	5.2E-03	10.4E-03	8.0E-03	13.2E-03	399.6E-06
9	-	-1.2E-03	-400.5E-06	399.6E-06	-2.4E-03	8.0E-03	10.0E-03	12.0E-03	5.2E-03	10.4E-03	8.0E-03	13.2E-03	399.6E-06
10	-	-800.1E-06	-400.5E-06	399.6E-06	-2.4E-03	8.4E-03	10.0E-03	12.0E-03	5.2E-03	10.4E-03	8.4E-03	13.2E-03	399.6E-06
Average	-	-1.1E-03	-400.5E-06	399.6E-06	-2.4E-03	8.1E-03	10.0E-03	12.0E-03	5.2E-03	10.4E-03	8.1E-03	13.2E-03	399.6E-06
Sigma	-	188.8E-06	0.0E+00	0.0E+00	0.0E+00	188.8E-06	95.1E-12	0.0E+00	0.0E+00	67.2E-12	188.8E-06	95.1E-12	0.0E+00

Parameter : Voltage Output : VOH\_B

Test conditions : VS=12V

Unit : V

Spec Limit Min : 11.25

Spec limits are represented in bold lines on the graphic.

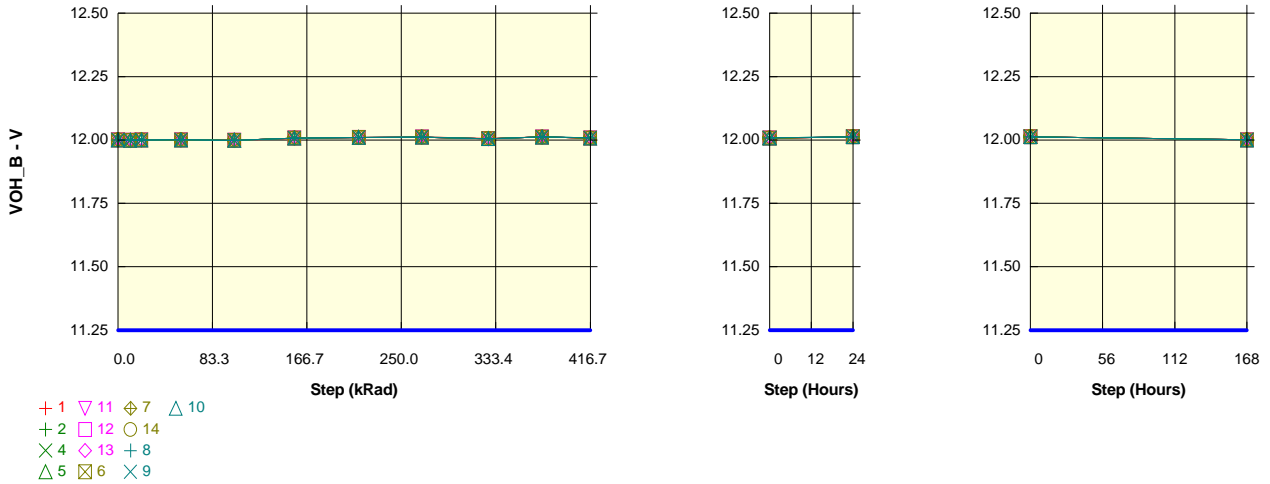

Measurements

VOH_B	0 kRad	10.8 kRad	20.7 kRad	55.6 kRad	102.6 kRad	155.7 kRad	212.4 kRad	268.2 kRad	326.7 kRad	374.2 kRad	416.7 kRad	24 Hours	168 Hours
1_REF	12.00	12.00	12.00	12.00	12.00	12.01	12.01	12.01	12.01	12.01	12.01	12.01	12.00
ON_PROTON samples													
2	12.00	12.00	12.00	12.00	12.00	12.01	12.01	12.01	12.01	12.01	12.01	12.01	12.00
4	12.00	12.00	12.00	12.00	12.00	12.01	12.01	12.01	12.01	12.01	12.01	12.01	12.00
5	12.00	12.00	12.00	12.00	12.00	12.01	12.01	12.01	12.01	12.01	12.01	12.01	12.00
Statistics													
Min	12.00	12.00	12.00	12.00	12.00	12.01	12.01	12.01	12.01	12.01	12.01	12.01	12.00
Max	12.00	12.00	12.00	12.00	12.00	12.01	12.01	12.01	12.01	12.01	12.01	12.01	12.00
Average	12.00	12.00	12.00	12.00	12.00	12.01	12.01	12.01	12.01	12.01	12.01	12.01	12.00
Sigma	0.00	0.00	0.00	0.00	0.00	0.00	0.00	0.00	0.00	0.00	0.00	0.00	0.00

Drift Calculation

VOH_B	0 kRad	10.8 kRad	20.7 kRad	55.6 kRad	102.6 kRad	155.7 kRad	212.4 kRad	268.2 kRad	326.7 kRad	374.2 kRad	416.7 kRad	24 Hours	168 Hours
ON_PROTON samples													
2	-	-1.2E-03	-399.6E-06	0.0E+00	-1.2E-03	7.2E-03	10.0E-03	11.2E-03	5.2E-03	11.6E-03	7.2E-03	12.0E-03	399.6E-06
4	-	-1.2E-03	-399.6E-06	0.0E+00	-1.2E-03	7.6E-03	10.0E-03	11.2E-03	5.2E-03	11.6E-03	7.2E-03	12.4E-03	399.6E-06
5	-	-1.2E-03	-399.6E-06	0.0E+00	-1.2E-03	7.6E-03	10.0E-03	11.2E-03	5.2E-03	11.6E-03	7.6E-03	12.4E-03	399.6E-06
Average	-	-1.2E-03	-399.6E-06	0.0E+00	-1.2E-03	7.5E-03	10.0E-03	11.2E-03	5.2E-03	11.6E-03	7.3E-03	12.3E-03	399.6E-06
Sigma	-	0.0E+00	0.0E+00	0.0E+00	0.0E+00	188.4E-06	95.1E-12	0.0E+00	33.6E-12	0.0E+00	188.4E-06	188.4E-06	0.0E+00

Measurements

VOH_B	0 kRad	10.8 kRad	20.7 kRad	55.6 kRad	102.6 kRad	155.7 kRad	212.4 kRad	268.2 kRad	326.7 kRad	374.2 kRad	416.7 kRad	24 Hours	168 Hours
1_REF	12.00	12.00	12.00	12.00	12.00	12.01	12.01	12.01	12.01	12.01	12.01	12.01	12.00
ON_TID samples													
11	12.00	12.00	12.00	12.00	12.00	12.01	12.01	12.01	12.01	12.01	12.01	12.01	12.00
12	12.00	12.00	12.00	12.00	12.00	12.01	12.01	12.01	12.01	12.01	12.01	12.01	12.00
13	12.00	12.00	12.00	12.00	12.00	12.01	12.01	12.01	12.01	12.01	12.01	12.01	12.00
Statistics													
Min	12.00	12.00	12.00	12.00	12.00	12.01	12.01	12.01	12.01	12.01	12.01	12.01	12.00
Max	12.00	12.00	12.00	12.00	12.00	12.01	12.01	12.01	12.01	12.01	12.01	12.01	12.00
Average	12.00	12.00	12.00	12.00	12.00	12.01	12.01	12.01	12.01	12.01	12.01	12.01	12.00
Sigma	0.00	0.00	0.00	0.00	0.00	0.00	0.00	0.00	0.00	0.00	0.00	0.00	0.00

Drift Calculation

VOH_B	0 kRad	10.8 kRad	20.7 kRad	55.6 kRad	102.6 kRad	155.7 kRad	212.4 kRad	268.2 kRad	326.7 kRad	374.2 kRad	416.7 kRad	24 Hours	168 Hours
ON_TID samples													
11	-	-1.2E-03	-399.6E-06	0.0E+00	-1.2E-03	7.6E-03	10.0E-03	11.2E-03	5.2E-03	11.6E-03	7.6E-03	12.4E-03	399.6E-06
12	-	-800.1E-06	-399.6E-06	0.0E+00	-1.2E-03	7.6E-03	10.0E-03	11.2E-03	5.2E-03	11.6E-03	7.6E-03	12.4E-03	399.6E-06
13	-	-800.1E-06	-399.6E-06	0.0E+00	-1.2E-03	7.6E-03	10.0E-03	11.2E-03	5.2E-03	11.6E-03	7.6E-03	12.4E-03	399.6E-06
Average	-	-933.3E-06	-399.6E-06	0.0E+00	-1.2E-03	7.6E-03	10.0E-03	11.2E-03	5.2E-03	11.6E-03	7.6E-03	12.4E-03	399.6E-06
Sigma	-	188.4E-06	0.0E+00	0.0E+00	0.0E+00	0.0E+00	95.1E-12	0.0E+00	33.6E-12	0.0E+00	0.0E+00	0.0E+00	0.0E+00

Hirex Engineering	Total Dose Radiation Test Report										Ref.:	HRX/TID/1013
	HS-4424BRH					Intersil					Issue:	01

**Measurements**

VOH_B	0 kRad	10.8 kRad	20.7 kRad	55.6 kRad	102.6 kRad	155.7 kRad	212.4 kRad	268.2 kRad	326.7 kRad	374.2 kRad	416.7 kRad	24 Hours	168 Hours
1_REF	12.00	12.00	12.00	12.00	12.00	12.01	12.01	12.01	12.01	12.01	12.01	12.01	12.00
OFF PROTON samples													
6	12.00	12.00	12.00	12.00	12.00	12.01	12.01	12.01	12.01	12.01	12.01	12.01	12.00
7	12.00	12.00	12.00	12.00	12.00	12.01	12.01	12.01	12.01	12.01	12.01	12.01	12.00
14	12.00	12.00	12.00	12.00	12.00	12.01	12.01	12.01	12.01	12.01	12.01	12.01	12.00
Statistics													
Min	12.00	12.00	12.00	12.00	12.00	12.01	12.01	12.01	12.01	12.01	12.01	12.01	12.00
Max	12.00	12.00	12.00	12.00	12.00	12.01	12.01	12.01	12.01	12.01	12.01	12.01	12.00
Average	12.00	12.00	12.00	12.00	12.00	12.01	12.01	12.01	12.01	12.01	12.01	12.01	12.00
Sigma	0.00	0.00	0.00	0.00	0.00	0.00	0.00	0.00	0.00	0.00	0.00	0.00	0.00

**Drift Calculation**

VOH_B	0 kRad	10.8 kRad	20.7 kRad	55.6 kRad	102.6 kRad	155.7 kRad	212.4 kRad	268.2 kRad	326.7 kRad	374.2 kRad	416.7 kRad	24 Hours	168 Hours
OFF PROTON samples													
6	-	-800.1E-06	-399.6E-06	399.6E-06	-1.2E-03	7.6E-03	10.0E-03	11.2E-03	5.2E-03	11.6E-03	7.6E-03	12.4E-03	399.6E-06
7	-	-2.0E-03	-399.6E-06	399.6E-06	-1.2E-03	7.6E-03	10.0E-03	11.2E-03	5.2E-03	11.6E-03	7.6E-03	12.4E-03	399.6E-06
14	-	-1.2E-03	-399.6E-06	399.6E-06	-1.2E-03	7.6E-03	10.0E-03	11.2E-03	5.2E-03	11.6E-03	7.6E-03	12.4E-03	399.6E-06
Average	-	-1.3E-03	-399.6E-06	399.6E-06	-1.2E-03	7.6E-03	10.0E-03	11.2E-03	5.2E-03	11.6E-03	7.6E-03	12.4E-03	399.6E-06
Sigma	-	498.8E-06	0.0E+00	0.0E+00	0.0E+00	0.0E+00	95.1E-12	0.0E+00	33.6E-12	0.0E+00	0.0E+00	0.0E+00	0.0E+00

**Measurements**

VOH_B	0 kRad	10.8 kRad	20.7 kRad	55.6 kRad	102.6 kRad	155.7 kRad	212.4 kRad	268.2 kRad	326.7 kRad	374.2 kRad	416.7 kRad	24 Hours	168 Hours
1_REF	12.00	12.00	12.00	12.00	12.00	12.01	12.01	12.01	12.01	12.01	12.01	12.01	12.00
OFF TID samples													
8	12.00	12.00	12.00	12.00	12.00	12.01	12.01	12.01	12.01	12.01	12.01	12.01	12.00
9	12.00	12.00	12.00	12.00	12.00	12.01	12.01	12.01	12.01	12.01	12.01	12.01	12.00
10	12.00	12.00	12.00	12.00	12.00	12.01	12.01	12.01	12.01	12.01	12.01	12.01	12.00
Statistics													
Min	12.00	12.00	12.00	12.00	12.00	12.01	12.01	12.01	12.01	12.01	12.01	12.01	12.00
Max	12.00	12.00	12.00	12.00	12.00	12.01	12.01	12.01	12.01	12.01	12.01	12.01	12.00
Average	12.00	12.00	12.00	12.00	12.00	12.01	12.01	12.01	12.01	12.01	12.01	12.01	12.00
Sigma	0.00	0.00	0.00	0.00	0.00	0.00	0.00	0.00	0.00	0.00	0.00	0.00	0.00

**Drift Calculation**

VOH_B	0 kRad	10.8 kRad	20.7 kRad	55.6 kRad	102.6 kRad	155.7 kRad	212.4 kRad	268.2 kRad	326.7 kRad	374.2 kRad	416.7 kRad	24 Hours	168 Hours
OFF TID samples													
8	-	-800.1E-06	-399.6E-06	399.6E-06	-1.2E-03	7.6E-03	10.0E-03	11.2E-03	5.2E-03	11.6E-03	8.0E-03	12.4E-03	399.6E-06
9	-	-1.2E-03	-399.6E-06	399.6E-06	-1.2E-03	7.6E-03	10.0E-03	11.2E-03	5.2E-03	11.6E-03	8.0E-03	12.4E-03	399.6E-06
10	-	-1.2E-03	-799.2E-06	0.0E+00	-1.6E-03	7.2E-03	9.6E-03	11.2E-03	4.8E-03	11.6E-03	7.6E-03	12.0E-03	0.0E+00
Average	-	-1.1E-03	-532.8E-06	266.4E-06	-1.3E-03	7.5E-03	9.9E-03	11.2E-03	5.1E-03	11.6E-03	7.9E-03	12.3E-03	266.4E-06
Sigma	-	188.4E-06	188.4E-06	188.4E-06	188.4E-06	188.4E-06	188.4E-06	0.0E+00	188.4E-06	449.6E-09	188.4E-06	188.4E-06	188.4E-06

Parameter : Propagation Delay. Low : TPHL\_A

Test conditions : VS=12V. CL=4300pF

Unit : s

Spec Limit Max : 250.0E-09

Spec limits are represented in bold lines on the graphic.

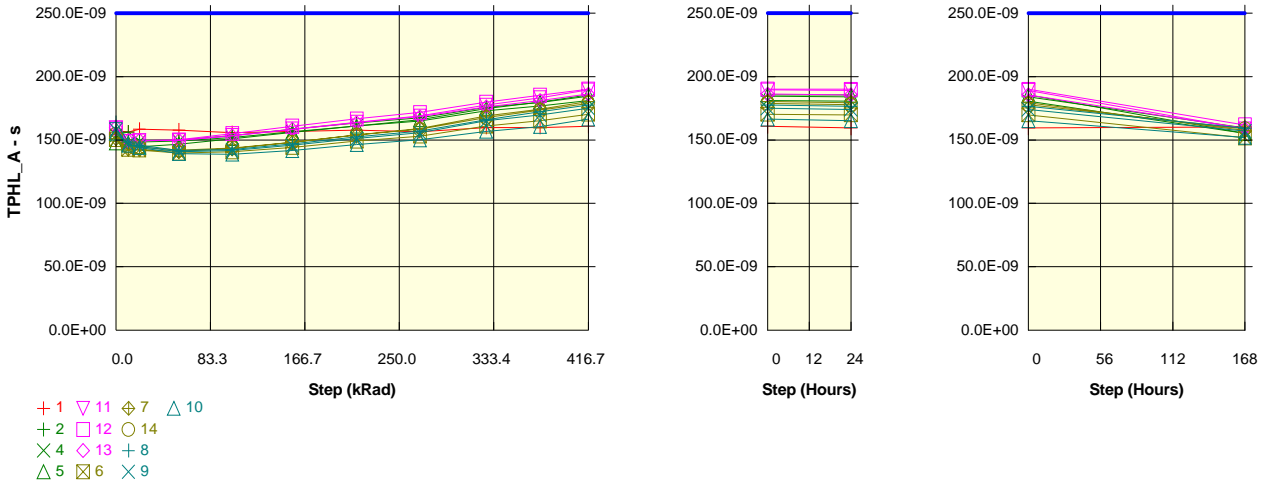

Measurements

TPHL_A	0 kRad	10.8 kRad	20.7 kRad	55.6 kRad	102.6 kRad	155.7 kRad	212.4 kRad	268.2 kRad	326.7 kRad	374.2 kRad	416.7 kRad	24 Hours	168 Hours
1_REF	157.4E-09	156.3E-09	158.5E-09	157.9E-09	155.9E-09	156.8E-09	157.6E-09	156.6E-09	159.9E-09	159.9E-09	160.7E-09	159.4E-09	160.4E-09
ON PROTON samples													
2	154.1E-09	156.3E-09	149.7E-09	149.8E-09	153.3E-09	158.6E-09	163.3E-09	167.5E-09	175.7E-09	179.7E-09	184.5E-09	183.9E-09	159.5E-09
4	153.5E-09	147.5E-09	148.4E-09	149.1E-09	151.8E-09	156.6E-09	161.1E-09	164.8E-09	172.9E-09	176.8E-09	181.2E-09	180.8E-09	155.3E-09
5	147.7E-09	147.5E-09	144.7E-09	146.6E-09	150.9E-09	155.9E-09	161.1E-09	166.0E-09	174.9E-09	179.8E-09	185.5E-09	185.3E-09	155.1E-09
Statistics													
Min	147.7E-09	147.5E-09	144.7E-09	146.6E-09	150.9E-09	155.9E-09	161.1E-09	164.8E-09	172.9E-09	176.8E-09	181.2E-09	180.8E-09	155.1E-09
Max	154.1E-09	156.3E-09	149.7E-09	149.8E-09	153.3E-09	158.6E-09	163.3E-09	167.5E-09	175.7E-09	179.8E-09	185.5E-09	185.3E-09	159.5E-09
Average	151.8E-09	150.4E-09	147.6E-09	148.5E-09	152.0E-09	157.0E-09	161.8E-09	166.1E-09	174.5E-09	178.7E-09	183.7E-09	183.3E-09	156.6E-09
Sigma	2.9E-09	4.2E-09	2.1E-09	1.3E-09	987.0E-12	1.1E-09	1.0E-09	1.1E-09	1.2E-09	1.4E-09	1.8E-09	1.9E-09	2.0E-09

Drift Calculation

TPHL_A	0 kRad	10.8 kRad	20.7 kRad	55.6 kRad	102.6 kRad	155.7 kRad	212.4 kRad	268.2 kRad	326.7 kRad	374.2 kRad	416.7 kRad	24 Hours	168 Hours
ON PROTON samples													
2	-	2.2E-09	-4.5E-09	-4.3E-09	-795.2E-12	4.4E-09	9.1E-09	13.4E-09	21.6E-09	25.6E-09	30.4E-09	29.7E-09	5.4E-09
4	-	-6.0E-09	-5.1E-09	-4.4E-09	-1.7E-09	3.1E-09	7.6E-09	11.3E-09	19.4E-09	23.3E-09	27.7E-09	27.2E-09	1.8E-09
5	-	-203.9E-12	-3.0E-09	-1.1E-09	3.2E-09	8.2E-09	13.4E-09	18.3E-09	27.2E-09	32.1E-09	37.8E-09	37.6E-09	7.4E-09
Average	-	-1.3E-09	-3.3E-09	-3.3E-09	254.4E-12	5.2E-09	10.1E-09	14.3E-09	22.7E-09	32.0E-09	32.0E-09	31.5E-09	4.9E-09
Sigma	-	3.4E-09	863.5E-12	1.6E-09	2.1E-09	2.2E-09	2.4E-09	2.9E-09	3.3E-09	3.7E-09	4.3E-09	4.4E-09	2.3E-09

Measurements

TPHL_A	0 kRad	10.8 kRad	20.7 kRad	55.6 kRad	102.6 kRad	155.7 kRad	212.4 kRad	268.2 kRad	326.7 kRad	374.2 kRad	416.7 kRad	24 Hours	168 Hours
1_REF	157.4E-09	156.3E-09	158.5E-09	157.9E-09	155.9E-09	156.8E-09	157.6E-09	156.6E-09	159.9E-09	159.9E-09	160.7E-09	159.4E-09	160.4E-09
ON TID samples													
11	159.5E-09	148.8E-09	149.5E-09	149.6E-09	153.5E-09	158.6E-09	163.9E-09	168.8E-09	177.6E-09	183.2E-09	189.5E-09	189.1E-09	158.7E-09
12	159.5E-09	148.7E-09	149.4E-09	150.1E-09	155.0E-09	160.8E-09	166.6E-09	171.7E-09	179.8E-09	185.3E-09	190.1E-09	189.9E-09	162.0E-09
13	160.1E-09	149.4E-09	149.7E-09	149.7E-09	153.3E-09	158.4E-09	163.5E-09	168.3E-09	176.1E-09	181.0E-09	186.2E-09	185.6E-09	159.0E-09
Statistics													
Min	159.5E-09	148.7E-09	149.4E-09	149.6E-09	153.3E-09	158.4E-09	163.5E-09	168.3E-09	176.1E-09	181.0E-09	186.2E-09	185.6E-09	158.7E-09
Max	160.1E-09	149.4E-09	149.7E-09	150.1E-09	155.0E-09	160.8E-09	166.6E-09	171.7E-09	179.8E-09	185.3E-09	190.1E-09	189.9E-09	162.0E-09
Average	159.7E-09	149.0E-09	149.5E-09	149.8E-09	153.9E-09	159.3E-09	164.7E-09	169.6E-09	177.8E-09	183.2E-09	188.6E-09	188.2E-09	159.9E-09
Sigma	277.8E-12	311.1E-12	132.7E-12	238.0E-12	787.9E-12	1.1E-09	1.4E-09	1.5E-09	1.5E-09	1.7E-09	1.7E-09	1.9E-09	1.5E-09

Drift Calculation

TPHL_A	0 kRad	10.8 kRad	20.7 kRad	55.6 kRad	102.6 kRad	155.7 kRad	212.4 kRad	268.2 kRad	326.7 kRad	374.2 kRad	416.7 kRad	24 Hours	168 Hours
ON TID samples													
11	-	-10.7E-09	-10.0E-09	-10.0E-09	-6.0E-09	-889.9E-12	4.4E-09	9.3E-09	18.0E-09	23.7E-09	29.9E-09	29.6E-09	-800.5E-12
12	-	-10.9E-09	-10.2E-09	-9.4E-09	-4.5E-09	1.3E-09	7.1E-09	12.1E-09	20.3E-09	25.8E-09	30.6E-09	30.4E-09	2.4E-09
13	-	-10.7E-09	-10.4E-09	-10.4E-09	-6.9E-09	-1.7E-09	3.4E-09	8.2E-09	16.0E-09	20.9E-09	26.0E-09	25.5E-09	-1.1E-09
Average	-	-10.8E-09	-10.2E-09	-9.9E-09	-5.8E-09	-443.5E-12	5.0E-09	9.9E-09	18.1E-09	23.5E-09	28.9E-09	28.5E-09	163.4E-12
Sigma	-	64.3E-12	168.3E-12	409.2E-12	979.2E-12	1.3E-09	1.6E-09	1.7E-09	1.8E-09	2.0E-09	2.0E-09	2.2E-09	1.6E-09

Hirex Engineering	Total Dose Radiation Test Report									Ref.:	HRX/TID/1013	
	HS-4424BRH				Intersil					Issue:	01	

**Measurements**

TPHL_A	0 kRad	10.8 kRad	20.7 kRad	55.6 kRad	102.6 kRad	155.7 kRad	212.4 kRad	268.2 kRad	326.7 kRad	374.2 kRad	416.7 kRad	24 Hours	168 Hours
1_REF	157.4E-09	156.3E-09	158.5E-09	157.9E-09	155.9E-09	156.8E-09	157.6E-09	156.6E-09	159.9E-09	159.9E-09	160.7E-09	159.4E-09	160.4E-09
OFF PROTON samples													
6	150.2E-09	142.6E-09	142.1E-09	139.6E-09	140.6E-09	144.2E-09	149.1E-09	153.0E-09	161.0E-09	165.1E-09	170.4E-09	169.7E-09	151.7E-09
7	151.0E-09	142.8E-09	142.4E-09	140.9E-09	143.2E-09	148.0E-09	153.9E-09	159.1E-09	168.9E-09	174.2E-09	180.4E-09	179.5E-09	157.6E-09
14	154.7E-09	145.3E-09	144.2E-09	142.0E-09	143.6E-09	148.2E-09	154.0E-09	158.5E-09	167.7E-09	173.6E-09	178.9E-09	177.8E-09	158.8E-09
Statistics													
Min	150.2E-09	142.6E-09	142.1E-09	139.6E-09	140.6E-09	144.2E-09	149.1E-09	153.0E-09	161.0E-09	165.1E-09	170.4E-09	169.7E-09	151.7E-09
Max	154.7E-09	145.3E-09	144.2E-09	142.0E-09	143.6E-09	148.2E-09	154.0E-09	159.1E-09	168.9E-09	174.2E-09	180.4E-09	179.5E-09	158.8E-09
Average	152.0E-09	143.6E-09	142.9E-09	140.9E-09	142.5E-09	146.8E-09	152.3E-09	156.9E-09	165.8E-09	171.0E-09	176.5E-09	175.7E-09	156.0E-09
Sigma	2.0E-09	1.2E-09	947.5E-12	970.5E-12	1.3E-09	1.8E-09	2.3E-09	2.7E-09	3.5E-09	4.2E-09	4.4E-09	4.2E-09	3.1E-09

**Drift Calculation**

TPHL_A	0 kRad	10.8 kRad	20.7 kRad	55.6 kRad	102.6 kRad	155.7 kRad	212.4 kRad	268.2 kRad	326.7 kRad	374.2 kRad	416.7 kRad	24 Hours	168 Hours
OFF PROTON samples													
6	-	-7.6E-09	-8.1E-09	-10.6E-09	-9.6E-09	-6.1E-09	-1.1E-09	2.8E-09	10.8E-09	14.9E-09	20.1E-09	19.5E-09	1.5E-09
7	-	-8.1E-09	-8.6E-09	-10.1E-09	-7.8E-09	-3.0E-09	3.0E-09	8.2E-09	17.9E-09	23.3E-09	29.4E-09	28.5E-09	6.6E-09
14	-	-9.4E-09	-10.5E-09	-12.7E-09	-11.1E-09	-6.5E-09	-707.4E-12	3.8E-09	12.9E-09	18.9E-09	24.2E-09	23.1E-09	4.1E-09
Average	-	-8.4E-09	-9.0E-09	-11.1E-09	-9.5E-09	-5.2E-09	379.5E-12	4.9E-09	13.9E-09	19.0E-09	24.6E-09	23.7E-09	4.1E-09
Sigma	-	762.2E-12	1.0E-09	1.1E-09	1.4E-09	1.6E-09	1.8E-09	2.3E-09	3.0E-09	3.4E-09	3.8E-09	3.7E-09	2.1E-09

**Measurements**

TPHL_A	0 kRad	10.8 kRad	20.7 kRad	55.6 kRad	102.6 kRad	155.7 kRad	212.4 kRad	268.2 kRad	326.7 kRad	374.2 kRad	416.7 kRad	24 Hours	168 Hours
1_REF	157.4E-09	156.3E-09	158.5E-09	157.9E-09	155.9E-09	156.8E-09	157.6E-09	156.6E-09	159.9E-09	159.9E-09	160.7E-09	159.4E-09	160.4E-09
OFF TID samples													
8	163.6E-09	148.4E-09	146.0E-09	141.6E-09	142.6E-09	146.9E-09	152.5E-09	157.0E-09	165.9E-09	172.2E-09	177.7E-09	176.6E-09	159.3E-09
9	157.8E-09	146.5E-09	144.8E-09	140.8E-09	141.9E-09	145.8E-09	151.1E-09	155.6E-09	165.1E-09	169.6E-09	175.1E-09	174.0E-09	157.0E-09
10	155.4E-09	146.0E-09	144.1E-09	139.3E-09	138.7E-09	141.7E-09	146.3E-09	150.1E-09	156.8E-09	160.7E-09	166.5E-09	165.2E-09	152.0E-09
Statistics													
Min	155.4E-09	146.0E-09	144.1E-09	139.3E-09	138.7E-09	141.7E-09	146.3E-09	150.1E-09	156.8E-09	160.7E-09	166.5E-09	165.2E-09	152.0E-09
Max	163.6E-09	148.4E-09	146.0E-09	141.6E-09	142.6E-09	146.9E-09	152.5E-09	157.0E-09	165.9E-09	172.2E-09	177.7E-09	176.6E-09	159.3E-09
Average	159.0E-09	146.9E-09	145.0E-09	140.6E-09	141.1E-09	144.8E-09	150.0E-09	154.2E-09	162.6E-09	167.5E-09	173.1E-09	172.0E-09	156.1E-09
Sigma	3.4E-09	1.0E-09	762.0E-12	986.7E-12	1.7E-09	2.2E-09	2.6E-09	3.0E-09	4.1E-09	4.9E-09	4.8E-09	4.9E-09	3.0E-09

**Drift Calculation**

TPHL_A	0 kRad	10.8 kRad	20.7 kRad	55.6 kRad	102.6 kRad	155.7 kRad	212.4 kRad	268.2 kRad	326.7 kRad	374.2 kRad	416.7 kRad	24 Hours	168 Hours
OFF TID samples													
8	-	-15.3E-09	-17.7E-09	-22.0E-09	-21.1E-09	-16.7E-09	-11.2E-09	-6.6E-09	2.3E-09	8.5E-09	14.1E-09	13.0E-09	-4.3E-09
9	-	-11.4E-09	-13.0E-09	-17.0E-09	-16.0E-09	-12.0E-09	-6.8E-09	-2.2E-09	7.3E-09	11.8E-09	17.3E-09	16.2E-09	-857.0E-12
10	-	-9.5E-09	-11.3E-09	-16.2E-09	-16.7E-09	-13.7E-09	-9.1E-09	-5.4E-09	1.4E-09	5.2E-09	11.0E-09	9.8E-09	-3.4E-09
Average	-	-12.0E-09	-14.0E-09	-18.4E-09	-17.9E-09	-14.2E-09	-9.0E-09	-4.7E-09	3.7E-09	8.5E-09	14.1E-09	13.0E-09	-2.9E-09
Sigma	-	2.4E-09	2.7E-09	2.6E-09	2.3E-09	1.9E-09	1.8E-09	1.9E-09	2.6E-09	2.7E-09	2.6E-09	2.6E-09	1.5E-09



Parameter : Popagation Delay. Low : TPHL\_B

Test conditions : VS=12V. CL=4300pF

Unit : s

Spec Limit Max : 250.0E-09

Spec limits are represented in bold lines on the graphic.

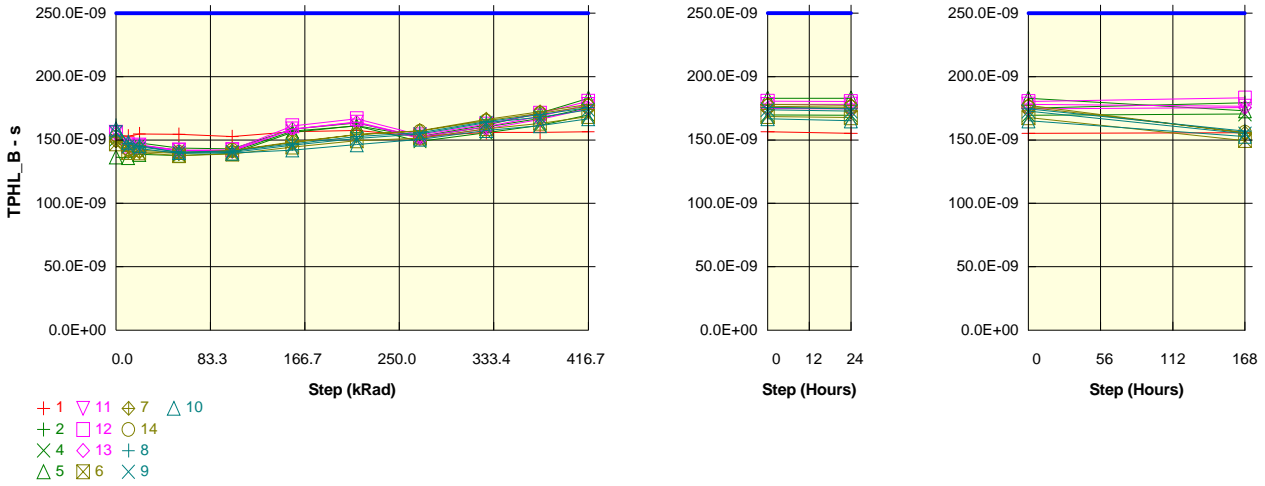

Measurements

TPHL_B	0 kRad	10.8 kRad	20.7 kRad	55.6 kRad	102.6 kRad	155.7 kRad	212.4 kRad	268.2 kRad	326.7 kRad	374.2 kRad	416.7 kRad	24 Hours	168 Hours
1_REF	154.1E-09	153.0E-09	154.8E-09	154.5E-09	152.6E-09	156.4E-09	157.5E-09	153.1E-09	156.0E-09	156.0E-09	156.5E-09	155.2E-09	155.6E-09
ON PROTON samples													
2	152.6E-09	146.6E-09	147.6E-09	143.6E-09	143.2E-09	158.7E-09	163.4E-09	152.4E-09	160.3E-09	166.9E-09	175.5E-09	175.1E-09	179.3E-09
4	150.2E-09	145.3E-09	145.7E-09	141.9E-09	140.6E-09	156.9E-09	161.1E-09	148.9E-09	155.7E-09	161.6E-09	169.8E-09	169.5E-09	170.5E-09
5	136.5E-09	135.9E-09	138.6E-09	137.8E-09	139.4E-09	156.1E-09	161.3E-09	152.8E-09	161.8E-09	171.4E-09	182.9E-09	183.0E-09	173.0E-09
Statistics													
Min	136.5E-09	135.9E-09	138.6E-09	137.8E-09	139.4E-09	156.1E-09	161.1E-09	148.9E-09	155.7E-09	161.6E-09	169.8E-09	169.5E-09	170.5E-09
Max	152.6E-09	146.6E-09	147.6E-09	143.6E-09	143.2E-09	158.7E-09	163.4E-09	152.8E-09	161.8E-09	171.4E-09	182.9E-09	183.0E-09	179.3E-09
Average	146.4E-09	142.6E-09	144.0E-09	141.1E-09	141.1E-09	157.2E-09	161.9E-09	151.4E-09	159.2E-09	166.6E-09	176.1E-09	175.9E-09	174.3E-09
Sigma	7.1E-09	4.8E-09	3.8E-09	2.4E-09	1.6E-09	1.1E-09	1.0E-09	1.7E-09	2.6E-09	4.0E-09	5.4E-09	5.5E-09	3.7E-09

Drift Calculation

TPHL_B	0 kRad	10.8 kRad	20.7 kRad	55.6 kRad	102.6 kRad	155.7 kRad	212.4 kRad	268.2 kRad	326.7 kRad	374.2 kRad	416.7 kRad	24 Hours	168 Hours
ON PROTON samples													
2	-	-6.0E-09	-5.0E-09	-9.0E-09	-9.4E-09	6.0E-09	10.8E-09	-234.3E-12	7.7E-09	14.3E-09	22.9E-09	22.5E-09	26.7E-09
4	-	-4.8E-09	-4.5E-09	-8.3E-09	-9.6E-09	6.7E-09	10.9E-09	-1.3E-09	5.5E-09	11.4E-09	19.6E-09	19.3E-09	20.3E-09
5	-	-505.0E-12	2.2E-09	1.4E-09	2.9E-09	19.6E-09	24.8E-09	16.3E-09	25.3E-09	34.9E-09	46.5E-09	46.5E-09	36.5E-09
Average	-	-3.8E-09	-2.5E-09	-5.3E-09	-5.4E-09	10.8E-09	15.5E-09	4.9E-09	12.8E-09	20.2E-09	29.7E-09	29.5E-09	27.8E-09
Sigma	-	2.4E-09	3.3E-09	4.7E-09	5.9E-09	6.2E-09	6.6E-09	8.0E-09	8.9E-09	10.5E-09	12.0E-09	12.1E-09	6.7E-09

Measurements

TPHL_B	0 kRad	10.8 kRad	20.7 kRad	55.6 kRad	102.6 kRad	155.7 kRad	212.4 kRad	268.2 kRad	326.7 kRad	374.2 kRad	416.7 kRad	24 Hours	168 Hours
1_REF	154.1E-09	153.0E-09	154.8E-09	154.5E-09	152.6E-09	156.4E-09	157.5E-09	153.1E-09	156.0E-09	156.0E-09	156.5E-09	155.2E-09	155.6E-09
ON TID samples													
11	156.2E-09	146.2E-09	146.0E-09	142.0E-09	141.8E-09	158.6E-09	164.1E-09	152.3E-09	160.5E-09	168.7E-09	178.0E-09	178.1E-09	176.6E-09
12	155.4E-09	145.3E-09	145.3E-09	141.6E-09	142.3E-09	161.1E-09	166.8E-09	154.0E-09	162.5E-09	171.0E-09	180.5E-09	180.3E-09	183.1E-09
13	155.0E-09	145.7E-09	145.3E-09	141.4E-09	141.2E-09	158.5E-09	163.8E-09	151.2E-09	158.7E-09	166.2E-09	174.8E-09	174.6E-09	175.6E-09
Statistics													
Min	155.0E-09	145.3E-09	145.3E-09	141.4E-09	141.2E-09	158.5E-09	163.8E-09	151.2E-09	158.7E-09	166.2E-09	174.8E-09	174.6E-09	175.6E-09
Max	156.2E-09	146.2E-09	146.0E-09	142.0E-09	142.3E-09	161.1E-09	166.8E-09	154.0E-09	162.5E-09	171.0E-09	180.5E-09	180.3E-09	183.1E-09
Average	155.5E-09	145.7E-09	145.5E-09	141.7E-09	141.8E-09	159.4E-09	164.9E-09	152.5E-09	160.6E-09	168.7E-09	177.8E-09	177.7E-09	178.4E-09
Sigma	475.8E-12	358.9E-12	347.7E-12	255.3E-12	445.2E-12	1.2E-09	1.3E-09	1.2E-09	1.5E-09	2.0E-09	2.3E-09	2.4E-09	3.3E-09

Drift Calculation

TPHL_B	0 kRad	10.8 kRad	20.7 kRad	55.6 kRad	102.6 kRad	155.7 kRad	212.4 kRad	268.2 kRad	326.7 kRad	374.2 kRad	416.7 kRad	24 Hours	168 Hours
ON TID samples													
11	-	-10.0E-09	-10.1E-09	-14.1E-09	-14.4E-09	2.4E-09	7.9E-09	-3.9E-09	4.3E-09	12.5E-09	21.9E-09	22.0E-09	20.5E-09
12	-	-10.1E-09	-10.1E-09	-13.7E-09	-13.1E-09	5.7E-09	11.4E-09	-1.4E-09	7.1E-09	15.6E-09	25.1E-09	24.9E-09	27.7E-09
13	-	-9.3E-09	-9.7E-09	-13.6E-09	-13.8E-09	3.5E-09	8.8E-09	-3.9E-09	3.7E-09	11.2E-09	19.8E-09	19.6E-09	20.6E-09
Average	-	-9.8E-09	-10.0E-09	-13.8E-09	-13.8E-09	3.9E-09	9.3E-09	-3.0E-09	5.0E-09	13.1E-09	22.3E-09	22.2E-09	22.9E-09
Sigma	-	353.3E-12	176.0E-12	220.8E-12	542.3E-12	1.4E-09	1.5E-09	1.2E-09	1.5E-09	1.9E-09	2.2E-09	2.2E-09	3.4E-09

Hirex Engineering	Total Dose Radiation Test Report									Ref.:	HRX/TID/1013	
	HS-4424BRH				Intersil					Issue:	01	

**Measurements**

TPHL_B	0 kRad	10.8 kRad	20.7 kRad	55.6 kRad	102.6 kRad	155.7 kRad	212.4 kRad	268.2 kRad	326.7 kRad	374.2 kRad	416.7 kRad	24 Hours	168 Hours
1_REF	154.1E-09	153.0E-09	154.8E-09	154.5E-09	152.6E-09	156.4E-09	157.5E-09	153.1E-09	156.0E-09	156.0E-09	156.5E-09	155.2E-09	155.6E-09
OFF PROTON samples													
6	146.9E-09	140.0E-09	139.9E-09	137.6E-09	139.0E-09	144.3E-09	149.3E-09	151.5E-09	158.9E-09	163.2E-09	168.5E-09	167.6E-09	149.4E-09
7	149.2E-09	141.1E-09	140.7E-09	139.5E-09	141.5E-09	147.9E-09	154.1E-09	157.3E-09	166.2E-09	172.2E-09	178.2E-09	177.4E-09	155.5E-09
14	152.0E-09	142.9E-09	142.0E-09	140.2E-09	141.8E-09	148.3E-09	154.2E-09	157.0E-09	165.1E-09	171.1E-09	176.6E-09	175.9E-09	156.1E-09
Statistics													
Min	146.9E-09	140.0E-09	139.9E-09	137.6E-09	139.0E-09	144.3E-09	149.3E-09	151.5E-09	158.9E-09	163.2E-09	168.5E-09	167.6E-09	149.4E-09
Max	152.0E-09	142.9E-09	142.0E-09	140.2E-09	141.8E-09	148.3E-09	154.2E-09	157.3E-09	166.2E-09	172.2E-09	178.2E-09	177.4E-09	155.5E-09
Average	149.4E-09	141.3E-09	140.9E-09	139.1E-09	140.7E-09	146.8E-09	152.6E-09	155.3E-09	163.4E-09	168.8E-09	174.4E-09	173.6E-09	153.7E-09
Sigma	2.1E-09	1.2E-09	874.7E-12	1.1E-09	1.3E-09	1.8E-09	2.3E-09	2.7E-09	3.2E-09	4.0E-09	4.2E-09	4.3E-09	3.0E-09

**Drift Calculation**

TPHL_B	0 kRad	10.8 kRad	20.7 kRad	55.6 kRad	102.6 kRad	155.7 kRad	212.4 kRad	268.2 kRad	326.7 kRad	374.2 kRad	416.7 kRad	24 Hours	168 Hours
OFF PROTON samples													
6	-	-6.9E-09	-7.0E-09	-9.3E-09	-7.9E-09	-2.6E-09	2.4E-09	4.6E-09	11.9E-09	16.3E-09	21.6E-09	20.7E-09	2.5E-09
7	-	-8.2E-09	-8.6E-09	-9.8E-09	-7.7E-09	-1.3E-09	4.8E-09	8.1E-09	17.0E-09	23.0E-09	29.0E-09	28.1E-09	6.3E-09
14	-	-9.1E-09	-10.0E-09	-11.8E-09	-10.2E-09	-3.7E-09	2.2E-09	5.0E-09	13.1E-09	19.1E-09	24.6E-09	23.9E-09	4.1E-09
Average	-	-8.1E-09	-8.5E-09	-10.3E-09	-8.6E-09	-2.5E-09	3.2E-09	5.9E-09	14.0E-09	19.5E-09	25.1E-09	24.2E-09	4.3E-09
Sigma	-	926.3E-12	1.2E-09	1.1E-09	1.1E-09	971.2E-12	1.2E-09	1.6E-09	2.2E-09	2.8E-09	3.0E-09	3.0E-09	1.5E-09

**Measurements**

TPHL_B	0 kRad	10.8 kRad	20.7 kRad	55.6 kRad	102.6 kRad	155.7 kRad	212.4 kRad	268.2 kRad	326.7 kRad	374.2 kRad	416.7 kRad	24 Hours	168 Hours
1_REF	154.1E-09	153.0E-09	154.8E-09	154.5E-09	152.6E-09	156.4E-09	157.5E-09	153.1E-09	156.0E-09	156.0E-09	156.5E-09	155.2E-09	155.6E-09
OFF TID samples													
8	161.4E-09	147.1E-09	144.6E-09	140.4E-09	141.2E-09	146.9E-09	152.7E-09	155.8E-09	164.3E-09	169.9E-09	175.6E-09	174.7E-09	157.1E-09
9	155.8E-09	144.8E-09	143.3E-09	139.6E-09	140.3E-09	145.9E-09	151.2E-09	154.7E-09	163.6E-09	168.0E-09	173.8E-09	172.7E-09	154.9E-09
10	158.8E-09	148.2E-09	145.5E-09	140.1E-09	139.6E-09	142.1E-09	146.2E-09	150.5E-09	157.4E-09	161.3E-09	166.7E-09	165.1E-09	152.8E-09
Statistics													
Min	155.8E-09	144.8E-09	143.3E-09	139.6E-09	139.6E-09	142.1E-09	146.2E-09	150.5E-09	157.4E-09	161.3E-09	166.7E-09	165.1E-09	152.8E-09
Max	161.4E-09	148.2E-09	145.5E-09	140.4E-09	141.2E-09	146.9E-09	152.7E-09	155.8E-09	164.3E-09	169.9E-09	175.6E-09	174.7E-09	157.1E-09
Average	158.6E-09	146.7E-09	144.4E-09	140.0E-09	140.4E-09	145.0E-09	150.0E-09	153.7E-09	161.8E-09	166.4E-09	172.0E-09	170.8E-09	154.9E-09
Sigma	2.3E-09	1.4E-09	901.4E-12	337.7E-12	657.8E-12	2.1E-09	2.8E-09	2.3E-09	3.1E-09	3.7E-09	3.8E-09	4.1E-09	1.8E-09

**Drift Calculation**

TPHL_B	0 kRad	10.8 kRad	20.7 kRad	55.6 kRad	102.6 kRad	155.7 kRad	212.4 kRad	268.2 kRad	326.7 kRad	374.2 kRad	416.7 kRad	24 Hours	168 Hours
OFF TID samples													
8	-	-14.3E-09	-16.8E-09	-21.0E-09	-20.2E-09	-14.5E-09	-8.7E-09	-5.6E-09	2.9E-09	8.5E-09	14.2E-09	13.3E-09	-4.3E-09
9	-	-10.9E-09	-12.5E-09	-16.2E-09	-15.5E-09	-9.9E-09	-4.6E-09	-1.1E-09	7.8E-09	12.3E-09	18.0E-09	16.9E-09	-842.0E-12
10	-	-10.6E-09	-13.3E-09	-18.7E-09	-19.1E-09	-16.7E-09	-12.5E-09	-8.2E-09	-1.3E-09	2.6E-09	7.9E-09	6.4E-09	-6.0E-09
Average	-	-12.0E-09	-14.2E-09	-18.6E-09	-18.2E-09	-13.7E-09	-8.6E-09	-5.0E-09	3.1E-09	7.8E-09	13.4E-09	12.2E-09	-3.7E-09
Sigma	-	1.7E-09	1.9E-09	2.0E-09	2.0E-09	2.8E-09	3.2E-09	3.0E-09	3.7E-09	4.0E-09	4.2E-09	4.4E-09	2.1E-09

Parameter : Propagation Delay. High : TPLH\_A

Test conditions : VS=12V. CL=4300pF

Unit : s

Spec Limit Max : 250.0E-09

Spec limits are represented in bold lines on the graphic.

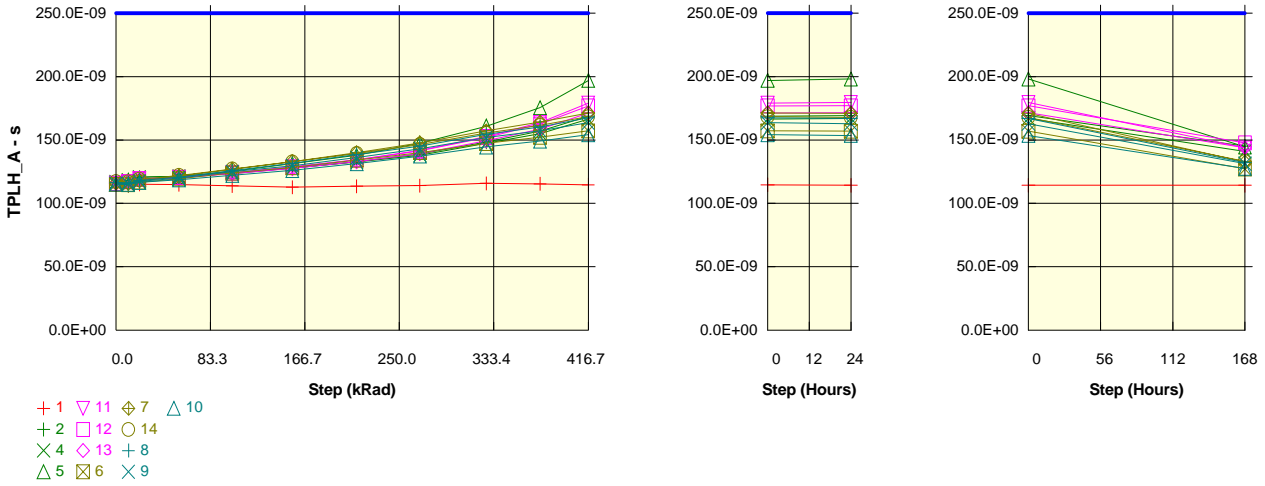

Measurements

TPLH_A	0 kRad	10.8 kRad	20.7 kRad	55.6 kRad	102.6 kRad	155.7 kRad	212.4 kRad	268.2 kRad	326.7 kRad	374.2 kRad	416.7 kRad	24 Hours	168 Hours
1_REF	115.0E-09	114.0E-09	115.1E-09	114.7E-09	113.7E-09	112.8E-09	113.5E-09	114.0E-09	115.8E-09	115.4E-09	114.6E-09	114.2E-09	114.3E-09
ON PROTON samples													
2	116.4E-09	114.0E-09	120.6E-09	121.4E-09	123.9E-09	127.9E-09	132.9E-09	139.1E-09	148.3E-09	157.1E-09	168.7E-09	169.2E-09	145.1E-09
4	117.0E-09	118.3E-09	120.6E-09	121.4E-09	123.6E-09	127.7E-09	132.5E-09	138.0E-09	147.3E-09	155.1E-09	166.4E-09	167.0E-09	141.1E-09
5	115.3E-09	118.3E-09	118.9E-09	121.0E-09	125.3E-09	131.3E-09	137.8E-09	147.4E-09	160.9E-09	175.6E-09	197.0E-09	198.1E-09	144.5E-09
Statistics													
Min	115.3E-09	114.0E-09	118.9E-09	121.0E-09	123.6E-09	127.7E-09	132.5E-09	138.0E-09	147.3E-09	155.1E-09	166.4E-09	167.0E-09	141.1E-09
Max	117.0E-09	118.3E-09	120.6E-09	121.4E-09	125.3E-09	131.3E-09	137.8E-09	147.4E-09	160.9E-09	175.6E-09	197.0E-09	198.1E-09	145.1E-09
Average	116.2E-09	116.9E-09	120.1E-09	121.3E-09	124.3E-09	129.0E-09	134.4E-09	141.5E-09	152.2E-09	162.6E-09	177.4E-09	178.1E-09	143.5E-09
Sigma	684.1E-12	2.0E-09	789.8E-12	186.8E-12	749.0E-12	1.7E-09	2.4E-09	4.2E-09	6.2E-09	9.2E-09	13.9E-09	14.2E-09	1.8E-09

Drift Calculation

TPLH_A	0 kRad	10.8 kRad	20.7 kRad	55.6 kRad	102.6 kRad	155.7 kRad	212.4 kRad	268.2 kRad	326.7 kRad	374.2 kRad	416.7 kRad	24 Hours	168 Hours
ON PROTON samples													
2	-	-2.5E-09	4.2E-09	4.9E-09	7.5E-09	11.5E-09	16.5E-09	22.6E-09	31.9E-09	40.7E-09	52.3E-09	52.7E-09	28.6E-09
4	-	1.4E-09	3.6E-09	4.4E-09	6.6E-09	10.8E-09	15.6E-09	21.1E-09	30.3E-09	38.1E-09	49.4E-09	50.0E-09	24.1E-09
5	-	3.0E-09	3.6E-09	5.7E-09	10.0E-09	16.0E-09	22.5E-09	32.1E-09	45.6E-09	60.2E-09	81.7E-09	82.8E-09	29.2E-09
Average	-	636.8E-12	3.8E-09	5.0E-09	8.0E-09	12.7E-09	18.2E-09	25.3E-09	35.9E-09	46.4E-09	61.1E-09	61.8E-09	27.3E-09
Sigma	-	2.3E-09	270.8E-12	505.1E-12	1.4E-09	2.3E-09	3.1E-09	4.9E-09	6.9E-09	9.9E-09	14.6E-09	14.8E-09	2.3E-09

Measurements

TPLH_A	0 kRad	10.8 kRad	20.7 kRad	55.6 kRad	102.6 kRad	155.7 kRad	212.4 kRad	268.2 kRad	326.7 kRad	374.2 kRad	416.7 kRad	24 Hours	168 Hours
1_REF	115.0E-09	114.0E-09	115.1E-09	114.7E-09	113.7E-09	112.8E-09	113.5E-09	114.0E-09	115.8E-09	115.4E-09	114.6E-09	114.2E-09	114.3E-09
ON TID samples													
11	115.9E-09	117.1E-09	119.4E-09	120.6E-09	124.1E-09	128.7E-09	134.4E-09	141.7E-09	152.8E-09	163.7E-09	179.0E-09	179.6E-09	143.7E-09
12	115.4E-09	116.9E-09	119.0E-09	120.3E-09	123.8E-09	128.6E-09	134.2E-09	141.5E-09	151.8E-09	162.5E-09	176.9E-09	177.0E-09	147.7E-09
13	115.8E-09	116.8E-09	119.0E-09	120.2E-09	123.4E-09	127.5E-09	132.8E-09	139.3E-09	149.3E-09	158.6E-09	171.3E-09	171.4E-09	143.9E-09
Statistics													
Min	115.4E-09	116.8E-09	119.0E-09	120.2E-09	123.4E-09	127.5E-09	132.8E-09	139.3E-09	149.3E-09	158.6E-09	171.3E-09	171.4E-09	143.7E-09
Max	115.9E-09	117.1E-09	119.4E-09	120.6E-09	124.1E-09	128.7E-09	134.4E-09	141.7E-09	152.8E-09	163.7E-09	179.0E-09	179.6E-09	147.7E-09
Average	115.7E-09	117.0E-09	119.1E-09	120.4E-09	123.8E-09	128.3E-09	133.8E-09	140.9E-09	151.3E-09	161.6E-09	175.7E-09	176.0E-09	145.1E-09
Sigma	197.5E-12	139.6E-12	220.4E-12	155.3E-12	265.2E-12	551.1E-12	706.3E-12	1.1E-09	1.4E-09	2.2E-09	3.3E-09	3.4E-09	1.8E-09

Drift Calculation

TPLH_A	0 kRad	10.8 kRad	20.7 kRad	55.6 kRad	102.6 kRad	155.7 kRad	212.4 kRad	268.2 kRad	326.7 kRad	374.2 kRad	416.7 kRad	24 Hours	168 Hours
ON TID samples													
11	-	1.3E-09	3.5E-09	4.7E-09	8.2E-09	12.8E-09	18.5E-09	25.8E-09	36.9E-09	47.8E-09	63.1E-09	63.7E-09	27.8E-09
12	-	1.5E-09	3.5E-09	4.9E-09	8.4E-09	13.2E-09	18.7E-09	26.1E-09	36.4E-09	47.1E-09	61.4E-09	61.6E-09	32.2E-09
13	-	1.1E-09	3.2E-09	4.5E-09	7.6E-09	11.8E-09	17.1E-09	23.6E-09	33.6E-09	42.8E-09	55.5E-09	55.6E-09	28.1E-09
Average	-	1.3E-09	3.4E-09	4.7E-09	8.1E-09	12.6E-09	18.1E-09	25.2E-09	35.6E-09	45.9E-09	60.0E-09	60.3E-09	29.4E-09
Sigma	-	165.6E-12	153.9E-12	150.7E-12	307.9E-12	613.1E-12	747.4E-12	1.1E-09	1.4E-09	2.2E-09	3.3E-09	3.4E-09	2.0E-09

Hirex Engineering	Total Dose Radiation Test Report								Ref.:	HRX/TID/1013
	HS-4424BRH				Intersil				Issue:	01

**Measurements**

TPLH_A	0 kRad	10.8 kRad	20.7 kRad	55.6 kRad	102.6 kRad	155.7 kRad	212.4 kRad	268.2 kRad	326.7 kRad	374.2 kRad	416.7 kRad	24 Hours	168 Hours
1_REF	115.0E-09	114.0E-09	115.1E-09	114.7E-09	113.7E-09	112.8E-09	113.5E-09	114.0E-09	115.8E-09	115.4E-09	114.6E-09	114.2E-09	114.3E-09
OFF PROTON samples													
6	115.0E-09	114.8E-09	116.6E-09	119.3E-09	123.9E-09	128.3E-09	134.0E-09	140.1E-09	147.4E-09	152.2E-09	157.2E-09	157.0E-09	127.2E-09
7	116.0E-09	115.7E-09	117.7E-09	121.3E-09	126.9E-09	133.0E-09	139.9E-09	147.6E-09	157.2E-09	164.0E-09	171.3E-09	170.9E-09	132.6E-09
14	117.2E-09	116.9E-09	118.9E-09	122.0E-09	127.1E-09	132.8E-09	139.3E-09	146.4E-09	155.5E-09	161.5E-09	168.4E-09	167.8E-09	133.0E-09
Statistics													
Min	115.0E-09	114.8E-09	116.6E-09	119.3E-09	123.9E-09	128.3E-09	134.0E-09	140.1E-09	147.4E-09	152.2E-09	157.2E-09	157.0E-09	127.2E-09
Max	117.2E-09	116.9E-09	118.9E-09	122.0E-09	127.1E-09	133.0E-09	139.9E-09	147.6E-09	157.2E-09	164.0E-09	171.3E-09	170.9E-09	133.0E-09
Average	116.1E-09	115.8E-09	117.8E-09	120.9E-09	125.9E-09	131.3E-09	137.7E-09	144.7E-09	153.4E-09	159.2E-09	165.6E-09	165.2E-09	131.0E-09
Sigma	930.6E-12	865.6E-12	928.8E-12	1.2E-09	1.5E-09	2.2E-09	2.6E-09	3.3E-09	4.3E-09	5.1E-09	6.1E-09	6.0E-09	2.6E-09

**Drift Calculation**

TPLH_A	0 kRad	10.8 kRad	20.7 kRad	55.6 kRad	102.6 kRad	155.7 kRad	212.4 kRad	268.2 kRad	326.7 kRad	374.2 kRad	416.7 kRad	24 Hours	168 Hours
OFF PROTON samples													
6	-	-146.9E-12	1.7E-09	4.3E-09	8.9E-09	13.3E-09	19.1E-09	25.1E-09	32.4E-09	37.2E-09	42.2E-09	42.0E-09	12.3E-09
7	-	-314.8E-12	1.7E-09	5.3E-09	10.9E-09	16.9E-09	23.9E-09	31.6E-09	41.2E-09	48.0E-09	55.2E-09	54.9E-09	16.5E-09
14	-	-311.4E-12	1.7E-09	4.8E-09	9.8E-09	15.5E-09	22.0E-09	29.2E-09	38.3E-09	44.3E-09	51.2E-09	50.5E-09	15.8E-09
Average	-	-257.7E-12	1.7E-09	4.8E-09	9.9E-09	15.3E-09	21.7E-09	28.6E-09	37.3E-09	43.2E-09	49.5E-09	49.1E-09	14.9E-09
Sigma	-	78.4E-12	4.9E-12	392.0E-12	801.3E-12	1.5E-09	2.0E-09	2.7E-09	3.7E-09	4.5E-09	5.4E-09	5.3E-09	1.9E-09

**Measurements**

TPLH_A	0 kRad	10.8 kRad	20.7 kRad	55.6 kRad	102.6 kRad	155.7 kRad	212.4 kRad	268.2 kRad	326.7 kRad	374.2 kRad	416.7 kRad	24 Hours	168 Hours
1_REF	115.0E-09	114.0E-09	115.1E-09	114.7E-09	113.7E-09	112.8E-09	113.5E-09	114.0E-09	115.8E-09	115.4E-09	114.6E-09	114.2E-09	114.3E-09
OFF TID samples													
8	116.4E-09	116.2E-09	118.1E-09	120.8E-09	125.8E-09	131.5E-09	138.6E-09	145.2E-09	154.4E-09	160.3E-09	167.6E-09	166.9E-09	132.2E-09
9	115.8E-09	115.6E-09	117.5E-09	119.9E-09	124.9E-09	129.7E-09	136.1E-09	143.1E-09	151.9E-09	157.3E-09	163.6E-09	162.9E-09	131.3E-09
10	115.1E-09	114.9E-09	116.6E-09	118.6E-09	122.2E-09	126.0E-09	131.3E-09	137.3E-09	144.6E-09	149.1E-09	154.2E-09	153.5E-09	127.6E-09
Statistics													
Min	115.1E-09	114.9E-09	116.6E-09	118.6E-09	122.2E-09	126.0E-09	131.3E-09	137.3E-09	144.6E-09	149.1E-09	154.2E-09	153.5E-09	127.6E-09
Max	116.4E-09	116.2E-09	118.1E-09	120.8E-09	125.8E-09	131.5E-09	138.6E-09	145.2E-09	154.4E-09	160.3E-09	167.6E-09	166.9E-09	132.2E-09
Average	115.8E-09	115.5E-09	117.4E-09	119.8E-09	124.3E-09	129.1E-09	135.3E-09	141.8E-09	150.3E-09	155.6E-09	161.8E-09	161.1E-09	130.3E-09
Sigma	533.9E-12	530.9E-12	604.2E-12	887.7E-12	1.5E-09	2.3E-09	3.0E-09	3.3E-09	4.2E-09	4.7E-09	5.6E-09	5.6E-09	2.0E-09

**Drift Calculation**

TPLH_A	0 kRad	10.8 kRad	20.7 kRad	55.6 kRad	102.6 kRad	155.7 kRad	212.4 kRad	268.2 kRad	326.7 kRad	374.2 kRad	416.7 kRad	24 Hours	168 Hours
OFF TID samples													
8	-	-261.1E-12	1.6E-09	4.3E-09	9.3E-09	15.1E-09	22.1E-09	28.7E-09	37.9E-09	43.8E-09	51.1E-09	50.5E-09	15.7E-09
9	-	-267.7E-12	1.7E-09	4.1E-09	9.1E-09	13.9E-09	20.3E-09	27.3E-09	36.1E-09	41.5E-09	47.8E-09	47.1E-09	15.5E-09
10	-	-254.0E-12	1.4E-09	3.5E-09	7.0E-09	10.9E-09	16.1E-09	22.1E-09	29.4E-09	33.9E-09	39.0E-09	38.4E-09	12.4E-09
Average	-	-260.9E-12	1.6E-09	4.0E-09	8.5E-09	13.3E-09	19.5E-09	26.0E-09	34.5E-09	39.8E-09	46.0E-09	45.3E-09	14.5E-09
Sigma	-	5.6E-12	95.0E-12	359.1E-12	1.0E-09	1.8E-09	2.5E-09	2.8E-09	3.7E-09	4.2E-09	5.1E-09	5.1E-09	1.5E-09

Parameter : Popagation Delay. High : TPLH\_B

Test conditions : VS=12V. CL=4300pF

Unit : s

Spec Limit Max : 250.0E-09

Spec limits are represented in bold lines on the graphic.

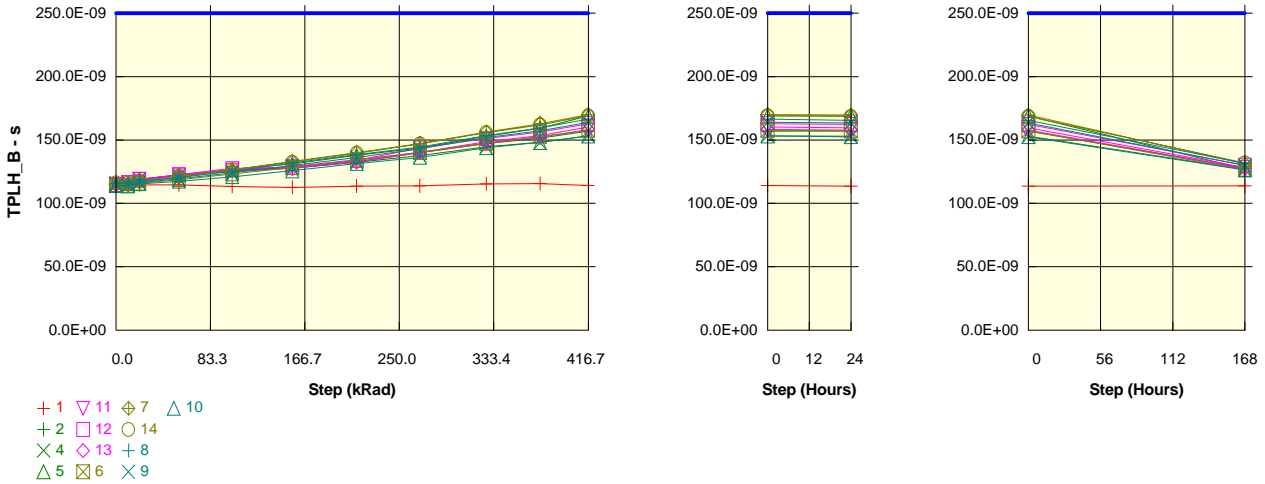

Measurements

TPLH_B	0 kRad	10.8 kRad	20.7 kRad	55.6 kRad	102.6 kRad	155.7 kRad	212.4 kRad	268.2 kRad	326.7 kRad	374.2 kRad	416.7 kRad	24 Hours	168 Hours
1_REF	114.7E-09	113.8E-09	114.7E-09	114.6E-09	113.4E-09	112.6E-09	113.6E-09	113.8E-09	115.4E-09	115.7E-09	114.0E-09	113.7E-09	113.7E-09
ON PROTON samples													
2	115.8E-09	116.7E-09	119.2E-09	122.5E-09	125.9E-09	128.0E-09	132.8E-09	140.0E-09	147.2E-09	151.5E-09	157.1E-09	156.9E-09	127.5E-09
4	116.1E-09	116.8E-09	119.0E-09	122.2E-09	125.1E-09	127.7E-09	132.4E-09	137.7E-09	144.5E-09	148.1E-09	153.3E-09	152.9E-09	126.8E-09
5	114.8E-09	115.7E-09	118.6E-09	122.5E-09	126.7E-09	131.2E-09	137.9E-09	143.5E-09	152.9E-09	159.4E-09	168.9E-09	169.0E-09	127.0E-09
Statistics													
Min	114.8E-09	115.7E-09	118.6E-09	122.2E-09	125.1E-09	127.7E-09	132.4E-09	137.7E-09	144.5E-09	148.1E-09	153.3E-09	152.9E-09	126.8E-09
Max	116.1E-09	116.8E-09	119.2E-09	122.5E-09	126.7E-09	131.2E-09	137.9E-09	143.5E-09	152.9E-09	159.4E-09	168.9E-09	169.0E-09	127.5E-09
Average	115.6E-09	116.4E-09	118.9E-09	122.4E-09	125.9E-09	129.0E-09	134.4E-09	140.4E-09	148.2E-09	153.0E-09	159.7E-09	159.6E-09	127.1E-09
Sigma	556.6E-12	499.2E-12	237.9E-12	146.2E-12	667.0E-12	1.6E-09	2.5E-09	2.4E-09	3.5E-09	4.8E-09	6.6E-09	6.8E-09	296.1E-12

Drift Calculation

TPLH_B	0 kRad	10.8 kRad	20.7 kRad	55.6 kRad	102.6 kRad	155.7 kRad	212.4 kRad	268.2 kRad	326.7 kRad	374.2 kRad	416.7 kRad	24 Hours	168 Hours
ON PROTON samples													
2	-	970.0E-12	3.4E-09	6.7E-09	10.1E-09	12.2E-09	17.0E-09	24.2E-09	31.4E-09	35.8E-09	41.3E-09	41.1E-09	11.7E-09
4	-	679.4E-12	2.9E-09	6.1E-09	9.0E-09	11.6E-09	16.3E-09	21.6E-09	28.4E-09	32.0E-09	37.2E-09	36.8E-09	10.7E-09
5	-	908.6E-12	3.8E-09	7.7E-09	11.9E-09	16.4E-09	23.1E-09	28.7E-09	38.1E-09	44.6E-09	54.1E-09	54.2E-09	12.2E-09
Average	-	852.7E-12	3.4E-09	6.8E-09	10.3E-09	13.4E-09	18.8E-09	24.8E-09	32.6E-09	37.4E-09	44.1E-09	44.1E-09	11.5E-09
Sigma	-	125.1E-12	398.3E-12	668.0E-12	1.2E-09	2.1E-09	3.0E-09	2.9E-09	4.1E-09	5.3E-09	7.2E-09	7.4E-09	631.0E-12

Measurements

TPLH_B	0 kRad	10.8 kRad	20.7 kRad	55.6 kRad	102.6 kRad	155.7 kRad	212.4 kRad	268.2 kRad	326.7 kRad	374.2 kRad	416.7 kRad	24 Hours	168 Hours
1_REF	114.7E-09	113.8E-09	114.7E-09	114.6E-09	113.4E-09	112.6E-09	113.6E-09	113.8E-09	115.4E-09	115.7E-09	114.0E-09	113.7E-09	113.7E-09
ON TID samples													
11	115.1E-09	116.5E-09	119.0E-09	122.4E-09	126.3E-09	129.0E-09	134.4E-09	140.4E-09	148.5E-09	153.4E-09	160.3E-09	159.7E-09	128.4E-09
12	114.6E-09	116.2E-09	118.9E-09	122.6E-09	127.4E-09	128.3E-09	133.9E-09	143.6E-09	151.1E-09	156.3E-09	162.9E-09	162.3E-09	130.2E-09
13	114.8E-09	115.9E-09	118.3E-09	122.0E-09	126.0E-09	127.5E-09	132.5E-09	140.1E-09	147.4E-09	152.3E-09	158.2E-09	157.8E-09	127.5E-09
Statistics													
Min	114.6E-09	115.9E-09	118.3E-09	122.0E-09	126.0E-09	127.5E-09	132.5E-09	140.1E-09	147.4E-09	152.3E-09	158.2E-09	157.8E-09	127.5E-09
Max	115.1E-09	116.5E-09	119.0E-09	122.6E-09	127.4E-09	129.0E-09	134.4E-09	143.6E-09	151.1E-09	156.3E-09	162.9E-09	162.3E-09	130.2E-09
Average	114.8E-09	116.2E-09	118.7E-09	122.3E-09	126.5E-09	128.3E-09	133.6E-09	141.3E-09	149.0E-09	154.0E-09	160.5E-09	159.9E-09	128.7E-09
Sigma	203.0E-12	245.3E-12	289.7E-12	234.1E-12	626.3E-12	583.7E-12	787.0E-12	1.6E-09	1.5E-09	1.7E-09	1.9E-09	1.9E-09	1.1E-09

Drift Calculation

TPLH_B	0 kRad	10.8 kRad	20.7 kRad	55.6 kRad	102.6 kRad	155.7 kRad	212.4 kRad	268.2 kRad	326.7 kRad	374.2 kRad	416.7 kRad	24 Hours	168 Hours
ON TID samples													
11	-	1.5E-09	3.9E-09	7.3E-09	11.2E-09	13.9E-09	19.3E-09	25.3E-09	33.5E-09	38.3E-09	45.2E-09	44.6E-09	13.4E-09
12	-	1.6E-09	4.3E-09	8.1E-09	12.9E-09	13.8E-09	19.3E-09	29.0E-09	36.5E-09	41.7E-09	48.3E-09	47.7E-09	15.6E-09
13	-	1.1E-09	3.6E-09	7.3E-09	11.2E-09	12.8E-09	17.8E-09	25.3E-09	32.6E-09	37.5E-09	43.5E-09	43.0E-09	12.8E-09
Average	-	1.4E-09	3.9E-09	7.6E-09	11.8E-09	13.5E-09	18.8E-09	26.5E-09	34.2E-09	39.2E-09	45.7E-09	45.1E-09	13.9E-09
Sigma	-	190.6E-12	304.2E-12	356.6E-12	779.7E-12	508.6E-12	742.2E-12	1.8E-09	1.7E-09	1.8E-09	2.0E-09	2.0E-09	1.2E-09

Hirex Engineering	Total Dose Radiation Test Report									Ref.:	HRX/TID/1013	
	HS-4424BRH				Intersil					Issue:	01	

**Measurements**

TPLH_B	0 kRad	10.8 kRad	20.7 kRad	55.6 kRad	102.6 kRad	155.7 kRad	212.4 kRad	268.2 kRad	326.7 kRad	374.2 kRad	416.7 kRad	24 Hours	168 Hours
1_REF	114.7E-09	113.8E-09	114.7E-09	114.6E-09	113.4E-09	112.6E-09	113.6E-09	113.8E-09	115.4E-09	115.7E-09	114.0E-09	113.7E-09	113.7E-09
OFF PROTON samples													
6	114.2E-09	114.2E-09	115.9E-09	118.7E-09	123.3E-09	128.2E-09	133.8E-09	140.2E-09	147.5E-09	152.7E-09	157.5E-09	157.3E-09	126.6E-09
7	115.1E-09	114.8E-09	116.8E-09	120.4E-09	126.3E-09	133.1E-09	140.1E-09	147.1E-09	156.3E-09	162.9E-09	170.0E-09	169.6E-09	131.2E-09
14	116.2E-09	116.2E-09	117.8E-09	121.5E-09	126.5E-09	132.6E-09	139.5E-09	146.9E-09	155.8E-09	162.0E-09	169.1E-09	168.5E-09	131.9E-09
Statistics													
Min	114.2E-09	114.2E-09	115.9E-09	118.7E-09	123.3E-09	128.2E-09	133.8E-09	140.2E-09	147.5E-09	152.7E-09	157.5E-09	157.3E-09	126.6E-09
Max	116.2E-09	116.2E-09	117.8E-09	121.5E-09	126.5E-09	133.1E-09	140.1E-09	147.1E-09	156.3E-09	162.9E-09	170.0E-09	169.6E-09	131.9E-09
Average	115.2E-09	115.1E-09	116.8E-09	120.2E-09	125.3E-09	131.3E-09	137.8E-09	144.7E-09	153.2E-09	159.2E-09	165.6E-09	165.1E-09	129.9E-09
Sigma	819.9E-12	844.2E-12	773.6E-12	1.2E-09	1.5E-09	2.2E-09	2.8E-09	3.2E-09	4.0E-09	4.6E-09	5.7E-09	5.6E-09	2.3E-09

**Drift Calculation**

TPLH_B	0 kRad	10.8 kRad	20.7 kRad	55.6 kRad	102.6 kRad	155.7 kRad	212.4 kRad	268.2 kRad	326.7 kRad	374.2 kRad	416.7 kRad	24 Hours	168 Hours
OFF PROTON samples													
6	-	-37.5E-12	1.7E-09	4.5E-09	9.1E-09	14.1E-09	19.7E-09	26.0E-09	33.3E-09	38.5E-09	43.4E-09	43.1E-09	12.4E-09
7	-	-249.5E-12	1.7E-09	5.4E-09	11.2E-09	18.0E-09	25.0E-09	32.0E-09	41.2E-09	47.8E-09	54.9E-09	54.5E-09	16.1E-09
14	-	-10.0E-12	1.6E-09	5.3E-09	10.3E-09	16.4E-09	23.3E-09	30.7E-09	39.6E-09	45.8E-09	52.9E-09	52.3E-09	15.7E-09
Average	-	-99.0E-12	1.7E-09	5.1E-09	10.2E-09	16.1E-09	22.7E-09	29.6E-09	38.0E-09	44.0E-09	50.4E-09	50.0E-09	14.7E-09
Sigma	-	107.0E-12	59.4E-12	384.6E-12	861.5E-12	1.6E-09	2.2E-09	2.6E-09	3.4E-09	4.0E-09	5.0E-09	5.0E-09	1.7E-09

**Measurements**

TPLH_B	0 kRad	10.8 kRad	20.7 kRad	55.6 kRad	102.6 kRad	155.7 kRad	212.4 kRad	268.2 kRad	326.7 kRad	374.2 kRad	416.7 kRad	24 Hours	168 Hours
1_REF	114.7E-09	113.8E-09	114.7E-09	114.6E-09	113.4E-09	112.6E-09	113.6E-09	113.8E-09	115.4E-09	115.7E-09	114.0E-09	113.7E-09	113.7E-09
OFF TID samples													
8	115.8E-09	115.8E-09	117.6E-09	120.4E-09	125.2E-09	131.7E-09	138.4E-09	144.3E-09	153.4E-09	159.4E-09	166.4E-09	165.5E-09	131.7E-09
9	114.4E-09	114.4E-09	116.4E-09	119.4E-09	124.0E-09	129.8E-09	136.3E-09	143.1E-09	151.9E-09	157.4E-09	163.8E-09	163.5E-09	129.8E-09
10	113.9E-09	113.6E-09	115.4E-09	117.4E-09	121.0E-09	125.6E-09	131.4E-09	136.3E-09	143.8E-09	148.1E-09	153.2E-09	152.5E-09	126.3E-09
Statistics													
Min	113.9E-09	113.6E-09	115.4E-09	117.4E-09	121.0E-09	125.6E-09	131.4E-09	136.3E-09	143.8E-09	148.1E-09	153.2E-09	152.5E-09	126.3E-09
Max	115.8E-09	115.8E-09	117.6E-09	120.4E-09	125.2E-09	131.7E-09	138.4E-09	144.3E-09	153.4E-09	159.4E-09	166.4E-09	165.5E-09	131.7E-09
Average	114.7E-09	114.6E-09	116.4E-09	119.1E-09	123.4E-09	129.1E-09	135.4E-09	141.2E-09	149.7E-09	155.0E-09	161.1E-09	160.5E-09	129.2E-09
Sigma	788.0E-12	931.8E-12	891.4E-12	1.3E-09	1.8E-09	2.5E-09	3.0E-09	3.5E-09	4.2E-09	4.9E-09	5.7E-09	5.7E-09	2.2E-09

**Drift Calculation**

TPLH_B	0 kRad	10.8 kRad	20.7 kRad	55.6 kRad	102.6 kRad	155.7 kRad	212.4 kRad	268.2 kRad	326.7 kRad	374.2 kRad	416.7 kRad	24 Hours	168 Hours
OFF TID samples													
8	-	48.6E-12	1.8E-09	4.6E-09	9.4E-09	16.0E-09	22.6E-09	28.5E-09	37.6E-09	43.6E-09	50.6E-09	49.7E-09	15.9E-09
9	-	-77.3E-12	2.0E-09	5.0E-09	9.6E-09	15.3E-09	21.8E-09	28.7E-09	37.5E-09	42.9E-09	49.4E-09	49.0E-09	15.3E-09
10	-	-327.6E-12	1.5E-09	3.5E-09	7.1E-09	11.7E-09	17.4E-09	22.4E-09	29.9E-09	34.2E-09	39.3E-09	38.6E-09	12.4E-09
Average	-	-118.8E-12	1.7E-09	4.4E-09	8.7E-09	14.3E-09	20.6E-09	26.5E-09	35.0E-09	40.3E-09	46.4E-09	45.8E-09	14.5E-09
Sigma	-	156.4E-12	210.4E-12	656.8E-12	1.1E-09	1.9E-09	2.3E-09	2.9E-09	3.6E-09	4.3E-09	5.1E-09	5.1E-09	1.5E-09

Parameter : Response Time. Rise : TR\_A

Test conditions : VS=12V. CL=4300pF

Unit : s

Spec Limit Max : 75.0E-09

Spec limits are represented in bold lines on the graphic.

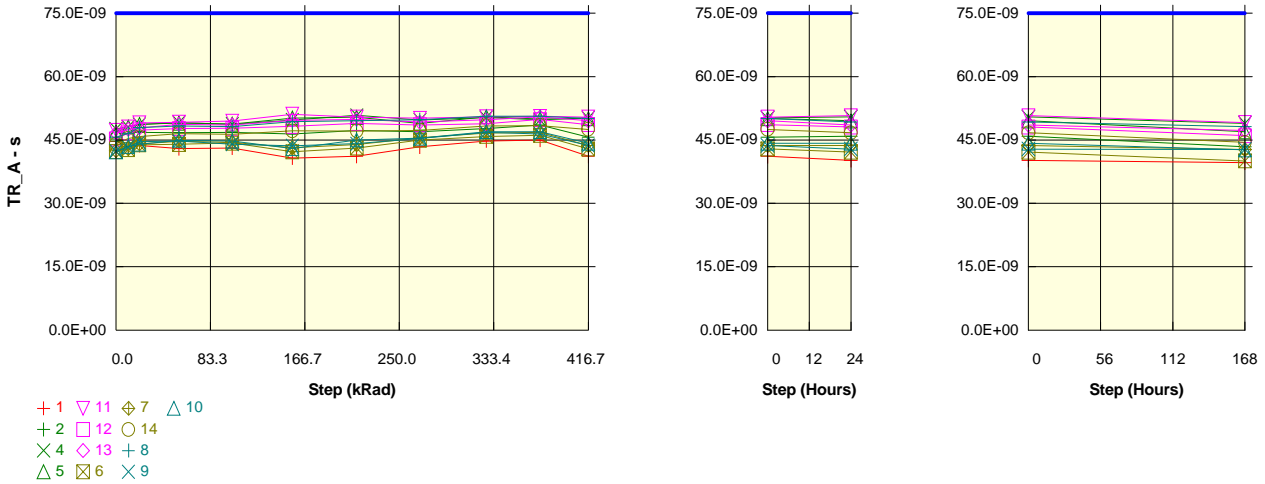

Measurements

TR_A	0 kRad	10.8 kRad	20.7 kRad	55.6 kRad	102.6 kRad	155.7 kRad	212.4 kRad	268.2 kRad	326.7 kRad	374.2 kRad	416.7 kRad	24 Hours	168 Hours
1_REF	44.7E-09	43.3E-09	43.7E-09	43.0E-09	43.1E-09	40.7E-09	41.1E-09	43.3E-09	44.8E-09	44.9E-09	41.1E-09	40.2E-09	39.6E-09
ON_PROTON samples													
2	44.7E-09	43.3E-09	46.8E-09	46.7E-09	46.8E-09	46.4E-09	47.3E-09	46.9E-09	47.7E-09	48.5E-09	45.7E-09	45.9E-09	43.4E-09
4	47.6E-09	48.1E-09	48.7E-09	49.1E-09	48.7E-09	49.7E-09	50.8E-09	49.7E-09	50.3E-09	49.7E-09	50.2E-09	50.4E-09	48.9E-09
5	46.9E-09	48.1E-09	48.7E-09	49.0E-09	48.8E-09	50.2E-09	50.4E-09	48.9E-09	50.5E-09	50.0E-09	50.0E-09	49.5E-09	46.9E-09
Statistics													
Min	44.7E-09	43.3E-09	46.8E-09	46.7E-09	46.8E-09	46.4E-09	47.3E-09	46.9E-09	47.7E-09	48.5E-09	45.7E-09	45.9E-09	43.4E-09
Max	47.6E-09	48.1E-09	48.7E-09	49.1E-09	48.8E-09	50.2E-09	50.8E-09	49.7E-09	50.5E-09	50.0E-09	50.2E-09	50.4E-09	48.9E-09
Average	46.4E-09	46.5E-09	48.1E-09	48.3E-09	48.1E-09	48.8E-09	49.5E-09	48.5E-09	49.5E-09	49.4E-09	48.6E-09	48.6E-09	46.4E-09
Sigma	1.2E-09	2.2E-09	880.6E-12	1.1E-09	916.1E-12	1.7E-09	1.6E-09	1.2E-09	1.3E-09	618.0E-12	2.1E-09	2.0E-09	2.3E-09

Drift Calculation

TR_A	0 kRad	10.8 kRad	20.7 kRad	55.6 kRad	102.6 kRad	155.7 kRad	212.4 kRad	268.2 kRad	326.7 kRad	374.2 kRad	416.7 kRad	24 Hours	168 Hours
ON_PROTON samples													
2	-	-1.4E-09	2.1E-09	2.0E-09	2.1E-09	1.7E-09	2.6E-09	2.2E-09	3.0E-09	3.8E-09	951.5E-12	1.1E-09	-1.3E-09
4	-	456.5E-12	1.0E-09	1.5E-09	1.1E-09	2.1E-09	3.2E-09	2.1E-09	2.6E-09	2.1E-09	2.6E-09	2.8E-09	1.3E-09
5	-	1.2E-09	1.8E-09	2.1E-09	1.9E-09	3.3E-09	3.5E-09	2.1E-09	3.6E-09	3.1E-09	3.2E-09	2.7E-09	90.9E-12
Average	-	102.1E-12	1.7E-09	1.9E-09	1.7E-09	2.4E-09	3.1E-09	2.1E-09	3.1E-09	3.0E-09	2.2E-09	2.2E-09	25.6E-12
Sigma	-	1.1E-09	441.2E-12	284.2E-12	428.9E-12	697.7E-12	393.7E-12	52.9E-12	412.8E-12	700.4E-12	945.6E-12	762.7E-12	1.1E-09

Measurements

TR_A	0 kRad	10.8 kRad	20.7 kRad	55.6 kRad	102.6 kRad	155.7 kRad	212.4 kRad	268.2 kRad	326.7 kRad	374.2 kRad	416.7 kRad	24 Hours	168 Hours
1_REF	44.7E-09	43.3E-09	43.7E-09	43.0E-09	43.1E-09	40.7E-09	41.1E-09	43.3E-09	44.8E-09	44.9E-09	41.1E-09	40.2E-09	39.6E-09
ON_TID samples													
11	47.3E-09	48.1E-09	49.0E-09	49.2E-09	49.5E-09	51.1E-09	50.4E-09	50.1E-09	50.5E-09	50.6E-09	50.4E-09	50.8E-09	49.1E-09
12	45.3E-09	46.7E-09	47.4E-09	47.7E-09	47.8E-09	48.2E-09	48.9E-09	48.6E-09	48.9E-09	49.8E-09	48.6E-09	48.1E-09	46.0E-09
13	46.6E-09	47.5E-09	47.8E-09	48.7E-09	48.6E-09	49.6E-09	49.9E-09	49.2E-09	49.8E-09	50.4E-09	49.5E-09	48.6E-09	47.2E-09
Statistics													
Min	45.3E-09	46.7E-09	47.4E-09	47.7E-09	47.8E-09	48.2E-09	48.9E-09	48.6E-09	48.9E-09	49.8E-09	48.6E-09	48.1E-09	46.0E-09
Max	47.3E-09	48.1E-09	49.0E-09	49.2E-09	49.5E-09	51.1E-09	50.4E-09	50.1E-09	50.5E-09	50.6E-09	50.4E-09	50.8E-09	49.1E-09
Average	46.4E-09	47.4E-09	48.1E-09	48.5E-09	48.6E-09	49.6E-09	49.7E-09	49.3E-09	49.7E-09	50.3E-09	49.5E-09	49.1E-09	47.5E-09
Sigma	829.9E-12	583.9E-12	700.0E-12	629.2E-12	698.6E-12	1.2E-09	598.2E-12	645.0E-12	641.0E-12	338.4E-12	728.8E-12	1.2E-09	1.3E-09

Drift Calculation

TR_A	0 kRad	10.8 kRad	20.7 kRad	55.6 kRad	102.6 kRad	155.7 kRad	212.4 kRad	268.2 kRad	326.7 kRad	374.2 kRad	416.7 kRad	24 Hours	168 Hours
ON_TID samples													
11	-	819.4E-12	1.8E-09	1.9E-09	2.2E-09	3.8E-09	3.1E-09	2.9E-09	3.2E-09	3.3E-09	3.2E-09	3.5E-09	1.8E-09
12	-	1.4E-09	2.1E-09	2.4E-09	2.5E-09	3.0E-09	3.7E-09	3.3E-09	3.6E-09	4.6E-09	3.4E-09	2.8E-09	751.4E-12
13	-	922.8E-12	1.2E-09	2.1E-09	2.0E-09	3.0E-09	3.3E-09	2.6E-09	3.2E-09	3.9E-09	3.0E-09	2.0E-09	636.8E-12
Average	-	1.0E-09	1.7E-09	2.2E-09	2.2E-09	3.3E-09	3.4E-09	2.9E-09	3.3E-09	3.9E-09	3.2E-09	2.7E-09	1.1E-09
Sigma	-	251.2E-12	350.1E-12	203.0E-12	209.9E-12	394.1E-12	232.7E-12	270.2E-12	201.6E-12	498.0E-12	169.2E-12	625.3E-12	545.3E-12

Hirex Engineering	Total Dose Radiation Test Report									Ref.:	HRX/TID/1013
	HS-4424BRH				Intersil					Issue:	01

**Measurements**

TR_A	0 kRad	10.8 kRad	20.7 kRad	55.6 kRad	102.6 kRad	155.7 kRad	212.4 kRad	268.2 kRad	326.7 kRad	374.2 kRad	416.7 kRad	24 Hours	168 Hours
1_REF	44.7E-09	43.3E-09	43.7E-09	43.0E-09	43.1E-09	40.7E-09	41.1E-09	43.3E-09	44.8E-09	44.9E-09	41.1E-09	40.2E-09	39.6E-09
OFF PROTON samples													
6	42.3E-09	42.7E-09	43.8E-09	44.0E-09	44.3E-09	42.2E-09	43.1E-09	44.9E-09	45.8E-09	46.1E-09	42.9E-09	42.1E-09	40.0E-09
7	42.5E-09	42.9E-09	44.1E-09	44.7E-09	44.4E-09	43.1E-09	43.9E-09	45.5E-09	46.6E-09	46.8E-09	43.7E-09	43.7E-09	42.7E-09
14	44.0E-09	45.4E-09	45.8E-09	46.5E-09	46.3E-09	47.1E-09	47.1E-09	47.3E-09	48.3E-09	48.4E-09	47.5E-09	46.7E-09	44.4E-09
Statistics													
Min	42.3E-09	42.7E-09	43.8E-09	44.0E-09	44.3E-09	42.2E-09	43.1E-09	44.9E-09	45.8E-09	46.1E-09	42.9E-09	42.1E-09	40.0E-09
Max	44.0E-09	45.4E-09	45.8E-09	46.5E-09	46.3E-09	47.1E-09	47.1E-09	47.3E-09	48.3E-09	48.4E-09	47.5E-09	46.7E-09	44.4E-09
Average	42.9E-09	43.7E-09	44.6E-09	45.1E-09	45.0E-09	44.2E-09	44.7E-09	45.9E-09	46.9E-09	47.1E-09	44.7E-09	44.2E-09	42.4E-09
Sigma	790.8E-12	1.2E-09	877.0E-12	1.1E-09	940.0E-12	2.1E-09	1.7E-09	990.0E-12	1.0E-09	983.0E-12	2.0E-09	1.9E-09	1.8E-09

**Drift Calculation**

TR_A	0 kRad	10.8 kRad	20.7 kRad	55.6 kRad	102.6 kRad	155.7 kRad	212.4 kRad	268.2 kRad	326.7 kRad	374.2 kRad	416.7 kRad	24 Hours	168 Hours
OFF PROTON samples													
6	-	491.3E-12	1.6E-09	1.7E-09	2.0E-09	-68.5E-12	835.6E-12	2.7E-09	3.6E-09	3.8E-09	627.1E-12	-108.3E-12	-2.2E-09
7	-	485.9E-12	1.6E-09	2.2E-09	2.0E-09	684.4E-12	1.4E-09	3.0E-09	4.2E-09	4.4E-09	1.2E-09	1.3E-09	276.0E-12
14	-	1.4E-09	1.8E-09	2.5E-09	2.3E-09	3.1E-09	3.1E-09	3.2E-09	4.3E-09	4.4E-09	3.5E-09	2.7E-09	393.1E-12
Average	-	778.9E-12	1.7E-09	2.1E-09	2.1E-09	1.2E-09	1.8E-09	3.0E-09	4.0E-09	4.2E-09	1.8E-09	1.3E-09	-515.8E-12
Sigma	-	410.5E-12	86.2E-12	318.0E-12	151.1E-12	1.4E-09	963.1E-12	227.4E-12	322.4E-12	263.4E-12	1.2E-09	1.1E-09	1.2E-09

**Measurements**

TR_A	0 kRad	10.8 kRad	20.7 kRad	55.6 kRad	102.6 kRad	155.7 kRad	212.4 kRad	268.2 kRad	326.7 kRad	374.2 kRad	416.7 kRad	24 Hours	168 Hours
1_REF	44.7E-09	43.3E-09	43.7E-09	43.0E-09	43.1E-09	40.7E-09	41.1E-09	43.3E-09	44.8E-09	44.9E-09	41.1E-09	40.2E-09	39.6E-09
OFF TID samples													
8	45.6E-09	46.6E-09	47.9E-09	48.3E-09	48.1E-09	49.3E-09	49.5E-09	49.8E-09	50.6E-09	50.6E-09	50.1E-09	49.2E-09	48.1E-09
9	42.4E-09	43.3E-09	44.6E-09	44.7E-09	44.0E-09	43.6E-09	44.1E-09	45.4E-09	46.8E-09	46.4E-09	43.7E-09	42.9E-09	42.8E-09
10	42.2E-09	43.5E-09	44.0E-09	44.9E-09	44.7E-09	43.0E-09	45.0E-09	45.4E-09	47.0E-09	47.0E-09	44.2E-09	44.2E-09	42.6E-09
Statistics													
Min	42.2E-09	43.3E-09	44.0E-09	44.7E-09	44.0E-09	43.0E-09	44.1E-09	45.4E-09	46.8E-09	46.4E-09	43.7E-09	42.9E-09	42.6E-09
Max	45.6E-09	46.6E-09	47.9E-09	48.3E-09	48.1E-09	49.3E-09	49.5E-09	49.8E-09	50.6E-09	50.6E-09	50.1E-09	49.2E-09	48.1E-09
Average	43.4E-09	44.5E-09	45.5E-09	46.0E-09	45.6E-09	45.3E-09	46.2E-09	46.9E-09	48.1E-09	48.0E-09	46.0E-09	45.4E-09	44.5E-09
Sigma	1.6E-09	1.5E-09	1.7E-09	1.7E-09	1.8E-09	2.8E-09	2.4E-09	2.1E-09	1.8E-09	1.8E-09	2.9E-09	2.7E-09	2.6E-09

**Drift Calculation**

TR_A	0 kRad	10.8 kRad	20.7 kRad	55.6 kRad	102.6 kRad	155.7 kRad	212.4 kRad	268.2 kRad	326.7 kRad	374.2 kRad	416.7 kRad	24 Hours	168 Hours
OFF TID samples													
8	-	964.9E-12	2.3E-09	2.7E-09	2.5E-09	3.7E-09	3.9E-09	4.2E-09	5.0E-09	5.0E-09	4.5E-09	3.6E-09	2.5E-09
9	-	915.9E-12	2.2E-09	2.3E-09	1.6E-09	1.3E-09	1.7E-09	3.0E-09	4.4E-09	4.1E-09	1.3E-09	484.7E-12	386.3E-12
10	-	1.3E-09	1.8E-09	2.7E-09	2.5E-09	765.7E-12	2.8E-09	3.2E-09	4.7E-09	4.8E-09	2.0E-09	2.0E-09	430.7E-12
Average	-	1.0E-09	2.1E-09	2.6E-09	2.2E-09	1.9E-09	2.8E-09	3.5E-09	4.7E-09	4.6E-09	2.6E-09	2.0E-09	1.1E-09
Sigma	-	153.7E-12	230.1E-12	174.4E-12	413.3E-12	1.3E-09	876.3E-12	514.6E-12	239.1E-12	381.4E-12	1.4E-09	1.3E-09	989.8E-12



Parameter : Response Time. Rise : TR\_B

Test conditions : VS=12V. CL=4300pF

Unit : s

Spec Limit Max : 75.0E-09

Spec limits are represented in bold lines on the graphic.

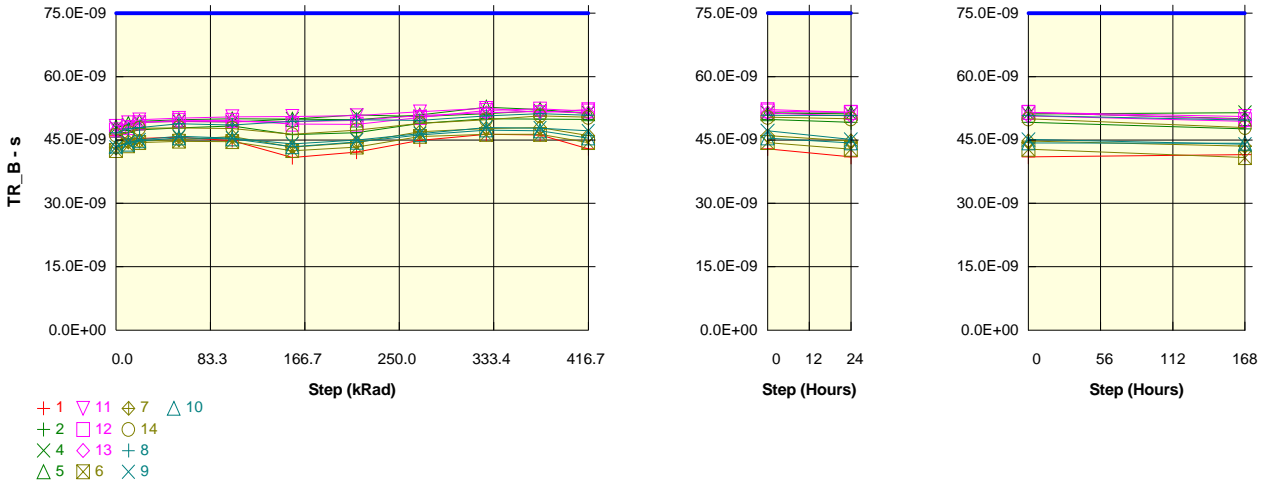

Measurements

TR_B	0 kRad	10.8 kRad	20.7 kRad	55.6 kRad	102.6 kRad	155.7 kRad	212.4 kRad	268.2 kRad	326.7 kRad	374.2 kRad	416.7 kRad	24 Hours	168 Hours
1_REF	46.1E-09	45.2E-09	45.3E-09	45.7E-09	44.8E-09	40.8E-09	42.1E-09	44.9E-09	46.3E-09	46.2E-09	42.9E-09	41.0E-09	41.6E-09
ON PROTON samples													
2	45.6E-09	46.8E-09	47.4E-09	47.9E-09	48.3E-09	46.2E-09	46.8E-09	49.0E-09	50.0E-09	49.9E-09	49.9E-09	49.1E-09	47.7E-09
4	47.9E-09	48.6E-09	49.2E-09	49.4E-09	49.2E-09	49.9E-09	50.9E-09	50.6E-09	51.2E-09	51.9E-09	51.4E-09	51.2E-09	51.5E-09
5	48.0E-09	48.9E-09	49.4E-09	49.7E-09	50.0E-09	49.9E-09	49.8E-09	50.9E-09	52.7E-09	52.2E-09	51.2E-09	51.5E-09	50.0E-09
Statistics													
Min	45.6E-09	46.8E-09	47.4E-09	47.9E-09	48.3E-09	46.2E-09	46.8E-09	49.0E-09	50.0E-09	49.9E-09	49.9E-09	49.1E-09	47.7E-09
Max	48.0E-09	48.9E-09	49.4E-09	49.7E-09	50.0E-09	49.9E-09	50.9E-09	50.9E-09	52.7E-09	52.2E-09	51.4E-09	51.5E-09	51.5E-09
Average	47.2E-09	48.1E-09	48.6E-09	49.0E-09	49.2E-09	48.7E-09	49.1E-09	50.1E-09	51.3E-09	51.4E-09	50.8E-09	50.6E-09	49.7E-09
Sigma	1.1E-09	934.3E-12	883.8E-12	796.1E-12	679.6E-12	1.7E-09	1.7E-09	840.0E-12	1.1E-09	1.0E-09	691.7E-12	1.0E-09	1.6E-09

Drift Calculation

TR_B	0 kRad	10.8 kRad	20.7 kRad	55.6 kRad	102.6 kRad	155.7 kRad	212.4 kRad	268.2 kRad	326.7 kRad	374.2 kRad	416.7 kRad	24 Hours	168 Hours
ON PROTON samples													
2	-	1.1E-09	1.8E-09	2.3E-09	2.7E-09	605.1E-12	1.1E-09	3.3E-09	4.3E-09	4.3E-09	4.2E-09	3.5E-09	2.0E-09
4	-	687.8E-12	1.3E-09	1.5E-09	1.3E-09	2.0E-09	3.0E-09	2.7E-09	3.3E-09	4.0E-09	3.5E-09	3.3E-09	3.6E-09
5	-	845.6E-12	1.3E-09	1.7E-09	2.0E-09	1.9E-09	1.7E-09	2.9E-09	4.7E-09	4.2E-09	3.2E-09	3.4E-09	2.0E-09
Average	-	888.4E-12	1.5E-09	1.8E-09	2.0E-09	1.5E-09	1.9E-09	2.9E-09	4.1E-09	4.2E-09	3.6E-09	3.4E-09	2.5E-09
Sigma	-	183.7E-12	218.9E-12	336.7E-12	570.8E-12	633.8E-12	772.8E-12	282.1E-12	605.3E-12	137.0E-12	434.3E-12	104.0E-12	735.5E-12

Measurements

TR_B	0 kRad	10.8 kRad	20.7 kRad	55.6 kRad	102.6 kRad	155.7 kRad	212.4 kRad	268.2 kRad	326.7 kRad	374.2 kRad	416.7 kRad	24 Hours	168 Hours
1_REF	46.1E-09	45.2E-09	45.3E-09	45.7E-09	44.8E-09	40.8E-09	42.1E-09	44.9E-09	46.3E-09	46.2E-09	42.9E-09	41.0E-09	41.6E-09
ON TID samples													
11	48.2E-09	49.0E-09	49.8E-09	50.1E-09	50.5E-09	50.6E-09	50.7E-09	51.7E-09	52.5E-09	51.5E-09	52.2E-09	51.5E-09	50.6E-09
12	47.4E-09	47.9E-09	49.1E-09	49.6E-09	49.6E-09	48.8E-09	48.7E-09	50.3E-09	52.0E-09	52.3E-09	51.8E-09	51.5E-09	49.8E-09
13	47.2E-09	48.0E-09	49.2E-09	49.3E-09	49.3E-09	49.3E-09	49.6E-09	50.7E-09	51.4E-09	51.8E-09	51.4E-09	50.7E-09	49.4E-09
Statistics													
Min	47.2E-09	47.9E-09	49.1E-09	49.3E-09	49.3E-09	48.8E-09	48.7E-09	50.3E-09	51.4E-09	51.5E-09	51.4E-09	50.7E-09	49.4E-09
Max	48.2E-09	49.0E-09	49.8E-09	50.1E-09	50.5E-09	50.6E-09	50.7E-09	51.7E-09	52.5E-09	52.3E-09	52.2E-09	51.5E-09	50.6E-09
Average	47.6E-09	48.3E-09	49.4E-09	49.7E-09	49.8E-09	49.5E-09	49.7E-09	50.9E-09	52.0E-09	51.9E-09	51.8E-09	51.2E-09	49.9E-09
Sigma	444.3E-12	523.5E-12	298.5E-12	334.4E-12	500.1E-12	745.8E-12	820.1E-12	561.2E-12	427.1E-12	352.1E-12	340.3E-12	394.2E-12	480.1E-12

Drift Calculation

TR_B	0 kRad	10.8 kRad	20.7 kRad	55.6 kRad	102.6 kRad	155.7 kRad	212.4 kRad	268.2 kRad	326.7 kRad	374.2 kRad	416.7 kRad	24 Hours	168 Hours
ON TID samples													
11	-	806.2E-12	1.5E-09	1.9E-09	2.3E-09	2.3E-09	2.5E-09	3.4E-09	4.3E-09	3.3E-09	4.0E-09	3.3E-09	2.3E-09
12	-	514.3E-12	1.7E-09	2.3E-09	2.3E-09	1.4E-09	1.4E-09	3.0E-09	4.6E-09	5.0E-09	4.5E-09	4.2E-09	2.5E-09
13	-	757.2E-12	2.0E-09	2.1E-09	2.1E-09	2.1E-09	2.4E-09	3.5E-09	4.2E-09	4.5E-09	4.1E-09	3.5E-09	2.2E-09
Average	-	692.6E-12	1.8E-09	2.1E-09	2.2E-09	1.9E-09	2.1E-09	3.3E-09	4.4E-09	4.3E-09	4.2E-09	3.6E-09	2.3E-09
Sigma	-	127.6E-12	196.5E-12	158.8E-12	84.9E-12	388.7E-12	513.4E-12	242.9E-12	191.5E-12	722.4E-12	208.9E-12	373.6E-12	124.4E-12

Hirex Engineering	Total Dose Radiation Test Report									Ref.:	HRX/TID/1013
	HS-4424BRH			Intersil			Issue:	01			

**Measurements**

TR_B	0 kRad	10.8 kRad	20.7 kRad	55.6 kRad	102.6 kRad	155.7 kRad	212.4 kRad	268.2 kRad	326.7 kRad	374.2 kRad	416.7 kRad	24 Hours	168 Hours
1_REF	46.1E-09	45.2E-09	45.3E-09	45.7E-09	44.8E-09	40.8E-09	42.1E-09	44.9E-09	46.3E-09	46.2E-09	42.9E-09	41.0E-09	41.6E-09
OFF PROTON samples													
6	42.5E-09	43.6E-09	44.4E-09	44.7E-09	44.6E-09	42.5E-09	43.3E-09	45.8E-09	46.3E-09	46.3E-09	44.4E-09	42.8E-09	40.8E-09
7	43.1E-09	44.6E-09	44.7E-09	45.0E-09	45.8E-09	43.3E-09	44.4E-09	46.9E-09	47.7E-09	47.9E-09	46.0E-09	44.8E-09	43.5E-09
14	46.2E-09	46.8E-09	47.8E-09	47.9E-09	47.7E-09	46.3E-09	47.4E-09	48.9E-09	49.8E-09	50.7E-09	50.4E-09	50.0E-09	47.9E-09
Statistics													
Min	42.5E-09	43.6E-09	44.4E-09	44.7E-09	44.6E-09	42.5E-09	43.3E-09	45.8E-09	46.3E-09	46.3E-09	44.4E-09	42.8E-09	40.8E-09
Max	46.2E-09	46.8E-09	47.8E-09	47.9E-09	47.7E-09	46.3E-09	47.4E-09	48.9E-09	49.8E-09	50.7E-09	50.4E-09	50.0E-09	47.9E-09
Average	43.9E-09	45.0E-09	45.6E-09	45.9E-09	46.1E-09	44.0E-09	45.0E-09	47.2E-09	47.9E-09	48.3E-09	46.9E-09	45.8E-09	44.1E-09
Sigma	1.6E-09	1.3E-09	1.5E-09	1.4E-09	1.3E-09	1.6E-09	1.7E-09	1.3E-09	1.4E-09	1.8E-09	2.5E-09	3.0E-09	2.9E-09

**Drift Calculation**

TR_B	0 kRad	10.8 kRad	20.7 kRad	55.6 kRad	102.6 kRad	155.7 kRad	212.4 kRad	268.2 kRad	326.7 kRad	374.2 kRad	416.7 kRad	24 Hours	168 Hours
OFF PROTON samples													
6	-	1.1E-09	1.9E-09	2.2E-09	2.1E-09	-45.4E-12	789.5E-12	3.3E-09	3.8E-09	3.8E-09	1.9E-09	277.6E-12	-1.7E-09
7	-	1.4E-09	1.6E-09	1.9E-09	2.7E-09	192.9E-12	1.3E-09	3.8E-09	4.6E-09	4.8E-09	2.9E-09	1.6E-09	379.5E-12
14	-	643.6E-12	1.6E-09	1.7E-09	1.6E-09	153.9E-12	1.2E-09	2.8E-09	3.6E-09	4.6E-09	4.2E-09	3.8E-09	1.8E-09
Average	-	1.1E-09	1.7E-09	1.9E-09	2.1E-09	100.5E-12	1.1E-09	3.3E-09	4.0E-09	4.4E-09	3.0E-09	1.9E-09	162.4E-12
Sigma	-	327.0E-12	122.0E-12	174.3E-12	459.8E-12	104.4E-12	212.7E-12	424.5E-12	408.6E-12	434.1E-12	959.6E-12	1.5E-09	1.4E-09

**Measurements**

TR_B	0 kRad	10.8 kRad	20.7 kRad	55.6 kRad	102.6 kRad	155.7 kRad	212.4 kRad	268.2 kRad	326.7 kRad	374.2 kRad	416.7 kRad	24 Hours	168 Hours
1_REF	46.1E-09	45.2E-09	45.3E-09	45.7E-09	44.8E-09	40.8E-09	42.1E-09	44.9E-09	46.3E-09	46.2E-09	42.9E-09	41.0E-09	41.6E-09
OFF TID samples													
8	46.7E-09	47.6E-09	48.0E-09	48.9E-09	48.6E-09	49.4E-09	49.8E-09	49.6E-09	50.7E-09	51.2E-09	50.9E-09	50.8E-09	49.7E-09
9	43.2E-09	44.4E-09	45.0E-09	45.9E-09	45.5E-09	44.1E-09	45.0E-09	46.5E-09	48.0E-09	47.8E-09	47.2E-09	45.1E-09	44.0E-09
10	43.6E-09	44.0E-09	44.8E-09	45.5E-09	45.3E-09	43.4E-09	44.5E-09	46.2E-09	47.4E-09	47.1E-09	45.4E-09	44.3E-09	44.2E-09
Statistics													
Min	43.2E-09	44.0E-09	44.8E-09	45.5E-09	45.3E-09	43.4E-09	44.5E-09	46.2E-09	47.4E-09	47.1E-09	45.4E-09	44.3E-09	44.0E-09
Max	46.7E-09	47.6E-09	48.0E-09	48.9E-09	48.6E-09	49.4E-09	49.8E-09	49.6E-09	50.7E-09	51.2E-09	50.9E-09	50.8E-09	49.7E-09
Average	44.5E-09	45.3E-09	45.9E-09	46.7E-09	46.4E-09	45.6E-09	46.4E-09	47.5E-09	48.7E-09	48.7E-09	47.8E-09	46.7E-09	46.0E-09
Sigma	1.6E-09	1.6E-09	1.5E-09	1.5E-09	1.5E-09	2.7E-09	2.4E-09	1.5E-09	1.5E-09	1.8E-09	2.3E-09	2.9E-09	2.6E-09

**Drift Calculation**

TR_B	0 kRad	10.8 kRad	20.7 kRad	55.6 kRad	102.6 kRad	155.7 kRad	212.4 kRad	268.2 kRad	326.7 kRad	374.2 kRad	416.7 kRad	24 Hours	168 Hours
OFF TID samples													
8	-	927.8E-12	1.3E-09	2.2E-09	1.9E-09	2.7E-09	3.1E-09	2.9E-09	4.0E-09	4.5E-09	4.2E-09	4.1E-09	3.0E-09
9	-	1.1E-09	1.8E-09	2.6E-09	2.2E-09	845.3E-12	1.7E-09	3.3E-09	4.7E-09	4.6E-09	3.9E-09	1.9E-09	726.1E-12
10	-	467.7E-12	1.2E-09	1.9E-09	1.7E-09	-167.2E-12	953.0E-12	2.7E-09	3.8E-09	3.6E-09	1.9E-09	730.6E-12	655.5E-12
Average	-	844.9E-12	1.4E-09	2.2E-09	1.9E-09	1.1E-09	1.9E-09	3.0E-09	4.2E-09	4.2E-09	3.3E-09	2.2E-09	1.5E-09
Sigma	-	280.4E-12	251.0E-12	279.3E-12	208.2E-12	1.2E-09	889.5E-12	260.2E-12	390.4E-12	450.6E-12	1.0E-09	1.4E-09	1.1E-09

Parameter : Response Time. Fall : TF\_A

Test conditions : VS=12V. CL=4300pF

Unit : s

Spec Limit Max : 75.0E-09

Spec limits are represented in bold lines on the graphic.

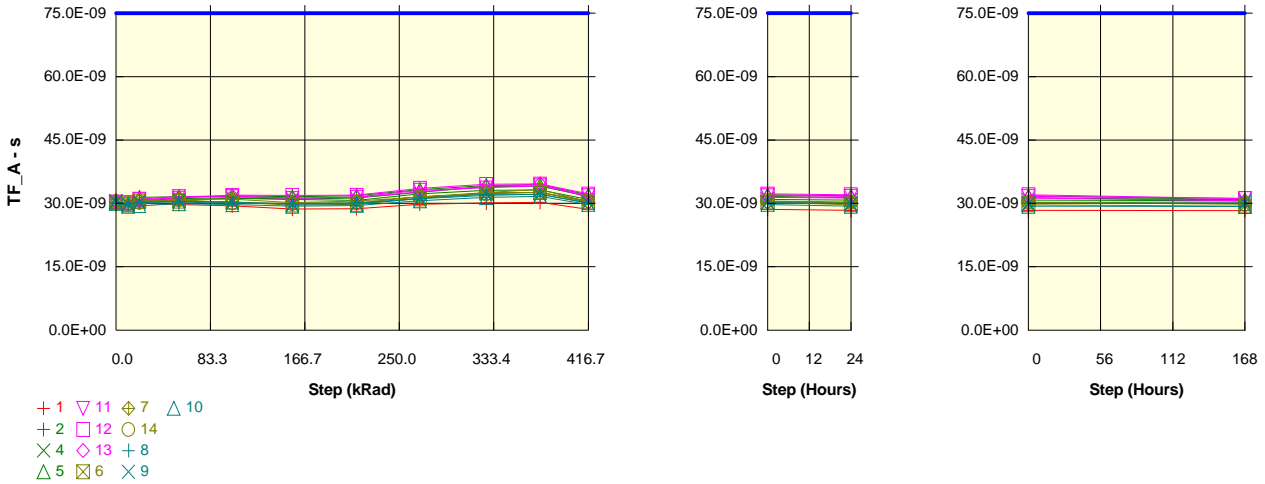

Measurements

TF_A	0 kRad	10.8 kRad	20.7 kRad	55.6 kRad	102.6 kRad	155.7 kRad	212.4 kRad	268.2 kRad	326.7 kRad	374.2 kRad	416.7 kRad	24 Hours	168 Hours
1_REF	30.2E-09	29.9E-09	30.1E-09	29.7E-09	29.4E-09	28.6E-09	28.8E-09	29.8E-09	30.1E-09	30.2E-09	28.6E-09	28.4E-09	28.3E-09
ON PROTON samples													
2	30.2E-09	29.9E-09	30.6E-09	31.1E-09	31.4E-09	31.0E-09	31.3E-09	32.6E-09	34.0E-09	34.0E-09	31.6E-09	31.4E-09	30.8E-09
4	30.5E-09	29.8E-09	30.5E-09	30.8E-09	31.2E-09	30.9E-09	30.7E-09	32.3E-09	33.1E-09	33.1E-09	31.0E-09	30.8E-09	30.6E-09
5	30.5E-09	29.8E-09	31.4E-09	31.6E-09	31.8E-09	31.6E-09	31.8E-09	33.2E-09	34.2E-09	34.3E-09	32.0E-09	31.7E-09	30.8E-09
Statistics													
Min	30.2E-09	29.8E-09	30.5E-09	30.8E-09	31.2E-09	30.9E-09	30.7E-09	32.3E-09	33.1E-09	33.1E-09	31.0E-09	30.8E-09	30.6E-09
Max	30.5E-09	29.9E-09	31.4E-09	31.6E-09	31.8E-09	31.6E-09	31.8E-09	33.2E-09	34.2E-09	34.3E-09	32.0E-09	31.7E-09	30.8E-09
Average	30.4E-09	29.8E-09	30.8E-09	31.2E-09	31.4E-09	31.2E-09	31.3E-09	32.7E-09	33.8E-09	33.8E-09	31.6E-09	31.3E-09	30.8E-09
Sigma	122.6E-12	22.5E-12	391.2E-12	301.2E-12	270.6E-12	276.9E-12	444.4E-12	406.8E-12	511.4E-12	518.3E-12	439.5E-12	408.4E-12	97.1E-12

Drift Calculation

TF_A	0 kRad	10.8 kRad	20.7 kRad	55.6 kRad	102.6 kRad	155.7 kRad	212.4 kRad	268.2 kRad	326.7 kRad	374.2 kRad	416.7 kRad	24 Hours	168 Hours
ON PROTON samples													
2	-	-354.7E-12	376.2E-12	898.0E-12	1.1E-09	790.6E-12	1.0E-09	2.4E-09	3.8E-09	3.8E-09	1.4E-09	1.1E-09	580.6E-12
4	-	-689.1E-12	-13.7E-12	299.1E-12	632.5E-12	403.6E-12	182.0E-12	1.7E-09	2.5E-09	2.6E-09	454.6E-12	235.5E-12	97.4E-12
5	-	-623.3E-12	928.8E-12	1.1E-09	1.3E-09	1.1E-09	1.3E-09	2.8E-09	3.8E-09	3.9E-09	1.6E-09	1.3E-09	377.4E-12
Average	-	-555.7E-12	430.4E-12	765.7E-12	1.0E-09	764.9E-12	849.3E-12	2.3E-09	3.4E-09	3.4E-09	1.1E-09	885.9E-12	351.8E-12
Sigma	-	144.6E-12	386.7E-12	340.1E-12	298.5E-12	285.1E-12	488.2E-12	431.4E-12	586.3E-12	587.4E-12	495.9E-12	464.8E-12	198.1E-12

Measurements

TF_A	0 kRad	10.8 kRad	20.7 kRad	55.6 kRad	102.6 kRad	155.7 kRad	212.4 kRad	268.2 kRad	326.7 kRad	374.2 kRad	416.7 kRad	24 Hours	168 Hours
1_REF	30.2E-09	29.9E-09	30.1E-09	29.7E-09	29.4E-09	28.6E-09	28.8E-09	29.8E-09	30.1E-09	30.2E-09	28.6E-09	28.4E-09	28.3E-09
ON TID samples													
11	30.2E-09	30.2E-09	31.0E-09	31.6E-09	31.6E-09	31.2E-09	31.5E-09	33.1E-09	33.7E-09	34.2E-09	31.8E-09	31.7E-09	31.2E-09
12	30.3E-09	30.1E-09	30.9E-09	31.2E-09	31.9E-09	31.9E-09	31.9E-09	33.6E-09	34.5E-09	34.6E-09	32.2E-09	32.0E-09	31.1E-09
13	30.6E-09	29.8E-09	30.8E-09	31.4E-09	31.7E-09	31.2E-09	31.4E-09	32.7E-09	34.0E-09	34.6E-09	31.4E-09	31.3E-09	30.6E-09
Statistics													
Min	30.2E-09	29.8E-09	30.8E-09	31.2E-09	31.6E-09	31.2E-09	31.4E-09	32.7E-09	33.7E-09	34.2E-09	31.4E-09	31.3E-09	30.6E-09
Max	30.6E-09	30.2E-09	31.0E-09	31.6E-09	31.9E-09	31.9E-09	31.9E-09	33.6E-09	34.5E-09	34.6E-09	32.2E-09	32.0E-09	31.2E-09
Average	30.4E-09	30.0E-09	30.9E-09	31.4E-09	31.7E-09	31.4E-09	31.6E-09	33.1E-09	34.1E-09	34.5E-09	31.8E-09	31.6E-09	31.0E-09
Sigma	193.6E-12	142.6E-12	80.7E-12	154.0E-12	139.8E-12	322.7E-12	234.5E-12	363.6E-12	342.3E-12	207.5E-12	328.6E-12	316.8E-12	247.8E-12

Drift Calculation

TF_A	0 kRad	10.8 kRad	20.7 kRad	55.6 kRad	102.6 kRad	155.7 kRad	212.4 kRad	268.2 kRad	326.7 kRad	374.2 kRad	416.7 kRad	24 Hours	168 Hours
ON TID samples													
11	-	28.8E-12	860.2E-12	1.5E-09	1.4E-09	1.0E-09	1.3E-09	3.0E-09	3.5E-09	4.0E-09	1.7E-09	1.5E-09	1.0E-09
12	-	-277.9E-12	531.9E-12	898.6E-12	1.6E-09	1.5E-09	1.6E-09	3.2E-09	4.2E-09	4.2E-09	1.9E-09	1.7E-09	803.9E-12
13	-	-786.4E-12	204.5E-12	770.5E-12	1.1E-09	597.5E-12	765.1E-12	2.0E-09	3.4E-09	4.0E-09	807.5E-12	633.9E-12	3.7E-12
Average	-	-345.2E-12	532.2E-12	1.0E-09	1.4E-09	1.0E-09	1.2E-09	2.7E-09	3.7E-09	4.1E-09	1.5E-09	1.3E-09	607.5E-12
Sigma	-	336.2E-12	267.7E-12	295.9E-12	218.3E-12	386.7E-12	343.2E-12	506.6E-12	344.8E-12	110.2E-12	474.9E-12	464.8E-12	435.5E-12

Hirex Engineering	Total Dose Radiation Test Report										Ref.:	HRX/TID/1013
	HS-4424BRH					Intersil					Issue:	01

**Measurements**

TF_A	0 kRad	10.8 kRad	20.7 kRad	55.6 kRad	102.6 kRad	155.7 kRad	212.4 kRad	268.2 kRad	326.7 kRad	374.2 kRad	416.7 kRad	24 Hours	168 Hours
1_REF	30.2E-09	29.9E-09	30.1E-09	29.7E-09	29.4E-09	28.6E-09	28.8E-09	29.8E-09	30.1E-09	30.2E-09	28.6E-09	28.4E-09	28.3E-09
OFF PROTON samples													
6	30.2E-09	29.6E-09	30.5E-09	30.5E-09	30.3E-09	29.6E-09	29.8E-09	31.1E-09	32.6E-09	32.6E-09	30.3E-09	29.7E-09	29.4E-09
7	30.3E-09	29.7E-09	30.5E-09	30.9E-09	31.0E-09	30.2E-09	30.6E-09	31.5E-09	32.6E-09	33.3E-09	30.3E-09	30.3E-09	30.3E-09
14	30.4E-09	30.0E-09	30.2E-09	30.9E-09	30.2E-09	30.0E-09	30.1E-09	31.6E-09	32.2E-09	32.7E-09	30.6E-09	30.2E-09	29.8E-09
Statistics													
Min	30.2E-09	29.6E-09	30.2E-09	30.5E-09	30.2E-09	29.6E-09	29.8E-09	31.1E-09	32.2E-09	32.6E-09	30.3E-09	29.7E-09	29.4E-09
Max	30.4E-09	30.0E-09	30.5E-09	30.9E-09	31.0E-09	30.2E-09	30.6E-09	31.6E-09	32.6E-09	33.3E-09	30.6E-09	30.3E-09	30.3E-09
Average	30.3E-09	29.8E-09	30.4E-09	30.8E-09	30.5E-09	29.9E-09	30.2E-09	31.4E-09	32.5E-09	32.8E-09	30.4E-09	30.1E-09	29.8E-09
Sigma	65.7E-12	157.0E-12	134.2E-12	173.1E-12	366.7E-12	249.4E-12	316.8E-12	204.5E-12	160.6E-12	336.6E-12	135.0E-12	283.8E-12	398.1E-12

**Drift Calculation**

TF_A	0 kRad	10.8 kRad	20.7 kRad	55.6 kRad	102.6 kRad	155.7 kRad	212.4 kRad	268.2 kRad	326.7 kRad	374.2 kRad	416.7 kRad	24 Hours	168 Hours
OFF PROTON samples													
6	-	-594.1E-12	289.7E-12	318.2E-12	100.7E-12	-637.3E-12	-430.3E-12	875.3E-12	2.3E-09	2.3E-09	106.0E-12	-557.1E-12	-850.1E-12
7	-	-573.6E-12	190.9E-12	647.6E-12	724.3E-12	-102.4E-12	272.3E-12	1.2E-09	2.3E-09	3.0E-09	11.5E-12	2.6E-12	51.7E-12
14	-	-385.4E-12	-168.4E-12	478.5E-12	-205.9E-12	-426.3E-12	-256.8E-12	1.2E-09	1.9E-09	2.3E-09	219.2E-12	-149.2E-12	-583.3E-12
Average	-	-517.7E-12	104.1E-12	481.4E-12	206.4E-12	-388.7E-12	-138.3E-12	1.1E-09	2.2E-09	2.5E-09	112.2E-12	-234.6E-12	-460.6E-12
Sigma	-	93.9E-12	196.8E-12	134.5E-12	387.0E-12	220.0E-12	298.8E-12	148.1E-12	220.7E-12	339.4E-12	84.9E-12	236.3E-12	378.2E-12

**Measurements**

TF_A	0 kRad	10.8 kRad	20.7 kRad	55.6 kRad	102.6 kRad	155.7 kRad	212.4 kRad	268.2 kRad	326.7 kRad	374.2 kRad	416.7 kRad	24 Hours	168 Hours
1_REF	30.2E-09	29.9E-09	30.1E-09	29.7E-09	29.4E-09	28.6E-09	28.8E-09	29.8E-09	30.1E-09	30.2E-09	28.6E-09	28.4E-09	28.3E-09
OFF TID samples													
8	30.2E-09	29.8E-09	30.3E-09	30.4E-09	30.0E-09	29.9E-09	30.1E-09	31.1E-09	31.8E-09	32.2E-09	30.0E-09	30.0E-09	30.0E-09
9	30.4E-09	29.8E-09	30.2E-09	30.5E-09	30.3E-09	29.8E-09	29.9E-09	31.2E-09	32.2E-09	32.1E-09	30.2E-09	30.0E-09	30.1E-09
10	30.0E-09	29.3E-09	29.5E-09	29.9E-09	29.7E-09	29.3E-09	29.5E-09	30.6E-09	31.4E-09	31.7E-09	29.8E-09	29.3E-09	29.3E-09
Statistics													
Min	30.0E-09	29.3E-09	29.5E-09	29.9E-09	29.7E-09	29.3E-09	29.5E-09	30.6E-09	31.4E-09	31.7E-09	29.8E-09	29.3E-09	29.3E-09
Max	30.4E-09	29.8E-09	30.3E-09	30.5E-09	30.3E-09	29.9E-09	30.1E-09	31.2E-09	32.2E-09	32.2E-09	30.2E-09	30.0E-09	30.1E-09
Average	30.2E-09	29.6E-09	30.0E-09	30.3E-09	30.0E-09	29.7E-09	29.8E-09	31.0E-09	31.8E-09	32.0E-09	30.0E-09	29.8E-09	29.8E-09
Sigma	160.0E-12	219.9E-12	395.5E-12	247.2E-12	253.1E-12	267.0E-12	251.1E-12	267.2E-12	321.0E-12	214.7E-12	188.2E-12	319.0E-12	384.3E-12

**Drift Calculation**

TF_A	0 kRad	10.8 kRad	20.7 kRad	55.6 kRad	102.6 kRad	155.7 kRad	212.4 kRad	268.2 kRad	326.7 kRad	374.2 kRad	416.7 kRad	24 Hours	168 Hours
OFF TID samples													
8	-	-366.4E-12	159.1E-12	170.3E-12	-147.1E-12	-246.0E-12	-66.1E-12	940.8E-12	1.6E-09	2.0E-09	-161.0E-12	-173.2E-12	-167.2E-12
9	-	-661.5E-12	-192.8E-12	90.0E-12	-75.0E-12	-627.5E-12	-545.2E-12	793.9E-12	1.8E-09	1.7E-09	-198.9E-12	-441.7E-12	-286.8E-12
10	-	-698.7E-12	-570.8E-12	-101.2E-12	-304.5E-12	-708.8E-12	-512.9E-12	582.3E-12	1.4E-09	1.6E-09	-267.0E-12	-705.4E-12	-759.3E-12
Average	-	-575.5E-12	-201.5E-12	53.0E-12	-175.5E-12	-527.4E-12	-374.7E-12	772.3E-12	1.6E-09	1.8E-09	-209.0E-12	-440.1E-12	-404.4E-12
Sigma	-	148.7E-12	298.0E-12	113.9E-12	95.8E-12	201.8E-12	218.6E-12	147.1E-12	165.5E-12	148.8E-12	43.9E-12	217.3E-12	255.6E-12

Parameter : Response Time. Fall : TF\_B

Test conditions : VS=12V. CL=4300pF

Unit : s

Spec Limit Max : 75.0E-09

Spec limits are represented in bold lines on the graphic.

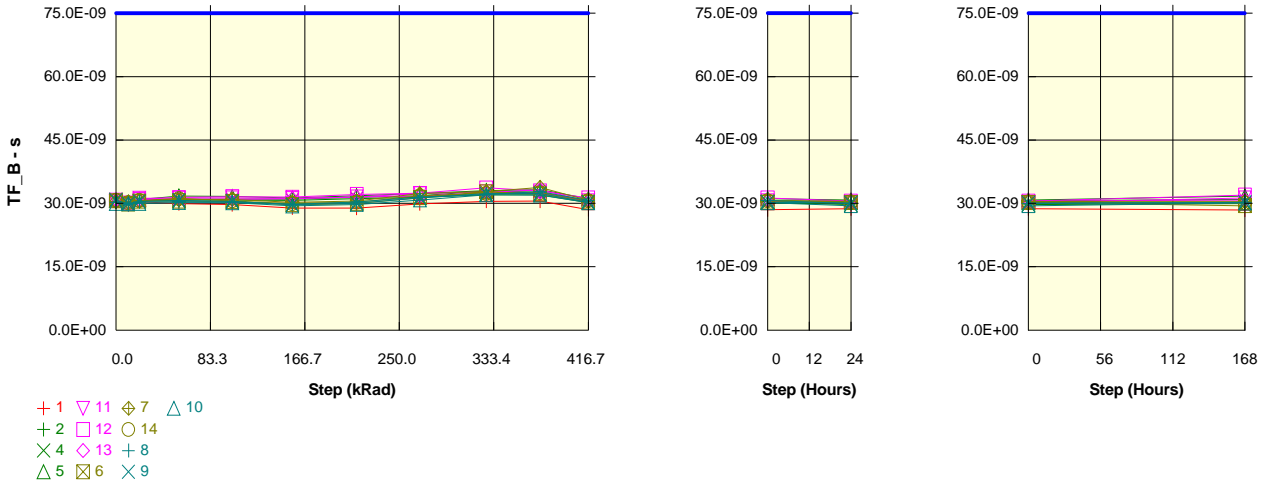

Measurements

TF_B	0 kRad	10.8 kRad	20.7 kRad	55.6 kRad	102.6 kRad	155.7 kRad	212.4 kRad	268.2 kRad	326.7 kRad	374.2 kRad	416.7 kRad	24 Hours	168 Hours
1_REF	30.5E-09	30.0E-09	30.4E-09	29.9E-09	29.7E-09	28.9E-09	28.9E-09	29.9E-09	30.5E-09	30.5E-09	28.5E-09	28.7E-09	28.4E-09
ON PROTON samples													
2	30.4E-09	30.0E-09	30.8E-09	31.0E-09	31.1E-09	31.0E-09	31.4E-09	31.8E-09	32.9E-09	32.6E-09	30.5E-09	30.6E-09	30.9E-09
4	30.9E-09	30.1E-09	30.7E-09	30.9E-09	30.8E-09	30.7E-09	31.1E-09	31.4E-09	32.0E-09	32.0E-09	30.1E-09	29.7E-09	30.0E-09
5	30.7E-09	30.3E-09	30.9E-09	31.7E-09	31.6E-09	31.3E-09	31.8E-09	32.3E-09	33.0E-09	33.2E-09	31.1E-09	30.8E-09	31.7E-09
Statistics													
Min	30.4E-09	30.0E-09	30.7E-09	30.9E-09	30.8E-09	30.7E-09	31.1E-09	31.4E-09	32.0E-09	32.0E-09	30.1E-09	29.7E-09	30.0E-09
Max	30.9E-09	30.3E-09	30.9E-09	31.7E-09	31.6E-09	31.3E-09	31.8E-09	32.3E-09	33.0E-09	33.2E-09	31.1E-09	30.8E-09	31.7E-09
Average	30.7E-09	30.1E-09	30.8E-09	31.2E-09	31.2E-09	31.0E-09	31.4E-09	31.8E-09	32.7E-09	32.6E-09	30.6E-09	30.4E-09	30.9E-09
Sigma	178.2E-12	133.3E-12	105.4E-12	368.5E-12	343.9E-12	235.7E-12	283.0E-12	382.4E-12	460.7E-12	511.7E-12	389.9E-12	483.9E-12	717.3E-12

Drift Calculation

TF_B	0 kRad	10.8 kRad	20.7 kRad	55.6 kRad	102.6 kRad	155.7 kRad	212.4 kRad	268.2 kRad	326.7 kRad	374.2 kRad	416.7 kRad	24 Hours	168 Hours
ON PROTON samples													
2	-	-438.5E-12	336.1E-12	599.9E-12	609.6E-12	598.5E-12	941.8E-12	1.3E-09	2.5E-09	2.2E-09	77.0E-12	181.9E-12	476.3E-12
4	-	-776.8E-12	-197.1E-12	31.0E-12	-70.8E-12	-171.1E-12	226.1E-12	541.1E-12	1.1E-09	1.1E-09	-718.2E-12	-1.2E-09	-907.7E-12
5	-	-420.5E-12	187.0E-12	1.0E-09	879.2E-12	529.4E-12	1.0E-09	1.6E-09	2.3E-09	2.5E-09	356.4E-12	62.8E-12	974.0E-12
Average	-	-545.3E-12	108.7E-12	544.2E-12	472.7E-12	318.9E-12	737.2E-12	1.2E-09	2.0E-09	1.9E-09	-94.9E-12	-308.0E-12	180.9E-12
Sigma	-	163.9E-12	224.6E-12	398.2E-12	399.7E-12	347.7E-12	363.8E-12	447.1E-12	594.9E-12	589.2E-12	455.2E-12	610.5E-12	796.1E-12

Measurements

TF_B	0 kRad	10.8 kRad	20.7 kRad	55.6 kRad	102.6 kRad	155.7 kRad	212.4 kRad	268.2 kRad	326.7 kRad	374.2 kRad	416.7 kRad	24 Hours	168 Hours
1_REF	30.5E-09	30.0E-09	30.4E-09	29.9E-09	29.7E-09	28.9E-09	28.9E-09	29.9E-09	30.5E-09	30.5E-09	28.5E-09	28.7E-09	28.4E-09
ON TID samples													
11	30.4E-09	29.9E-09	31.2E-09	31.2E-09	31.3E-09	31.1E-09	31.5E-09	32.3E-09	32.7E-09	32.5E-09	30.6E-09	30.2E-09	31.3E-09
12	30.8E-09	30.0E-09	30.9E-09	31.4E-09	31.6E-09	31.5E-09	32.1E-09	32.4E-09	33.7E-09	33.0E-09	31.2E-09	30.5E-09	31.9E-09
13	30.8E-09	30.2E-09	30.9E-09	31.0E-09	30.9E-09	31.1E-09	31.4E-09	31.7E-09	32.5E-09	33.2E-09	30.5E-09	30.6E-09	30.8E-09
Statistics													
Min	30.4E-09	29.9E-09	30.9E-09	31.0E-09	30.9E-09	31.1E-09	31.4E-09	31.7E-09	32.5E-09	32.5E-09	30.5E-09	30.2E-09	30.8E-09
Max	30.8E-09	30.2E-09	31.2E-09	31.4E-09	31.6E-09	31.5E-09	32.1E-09	32.4E-09	33.7E-09	33.2E-09	31.2E-09	30.6E-09	31.9E-09
Average	30.7E-09	30.0E-09	31.0E-09	31.2E-09	31.3E-09	31.2E-09	31.7E-09	32.1E-09	33.0E-09	32.9E-09	30.8E-09	30.4E-09	31.3E-09
Sigma	149.6E-12	158.9E-12	139.3E-12	171.1E-12	266.1E-12	168.3E-12	310.0E-12	303.2E-12	498.7E-12	300.4E-12	324.8E-12	187.4E-12	471.1E-12

Drift Calculation

TF_B	0 kRad	10.8 kRad	20.7 kRad	55.6 kRad	102.6 kRad	155.7 kRad	212.4 kRad	268.2 kRad	326.7 kRad	374.2 kRad	416.7 kRad	24 Hours	168 Hours
ON TID samples													
11	-	-594.1E-12	739.3E-12	794.4E-12	837.9E-12	701.9E-12	1.0E-09	1.9E-09	2.3E-09	2.0E-09	183.7E-12	-286.5E-12	807.8E-12
12	-	-718.3E-12	169.4E-12	607.2E-12	820.9E-12	708.4E-12	1.4E-09	1.6E-09	2.9E-09	2.2E-09	482.6E-12	-237.0E-12	1.2E-09
13	-	-521.8E-12	97.3E-12	197.7E-12	170.5E-12	326.4E-12	678.0E-12	937.4E-12	1.8E-09	2.4E-09	-260.4E-12	-181.2E-12	28.7E-12
Average	-	-611.4E-12	335.3E-12	533.1E-12	609.8E-12	578.9E-12	1.0E-09	1.5E-09	2.3E-09	2.2E-09	135.3E-12	-234.9E-12	670.4E-12
Sigma	-	81.1E-12	287.2E-12	249.2E-12	310.7E-12	178.6E-12	278.1E-12	388.5E-12	462.8E-12	166.9E-12	305.3E-12	43.0E-12	477.8E-12

Hirex Engineering	Total Dose Radiation Test Report										Ref.:	HRX/TID/1013
	HS-4424BRH					Intersil					Issue:	01

**Measurements**

TF_B	0 kRad	10.8 kRad	20.7 kRad	55.6 kRad	102.6 kRad	155.7 kRad	212.4 kRad	268.2 kRad	326.7 kRad	374.2 kRad	416.7 kRad	24 Hours	168 Hours
1_REF	30.5E-09	30.0E-09	30.4E-09	29.9E-09	29.7E-09	28.9E-09	28.9E-09	29.9E-09	30.5E-09	30.5E-09	28.5E-09	28.7E-09	28.4E-09
OFF PROTON samples													
6	30.6E-09	29.8E-09	30.6E-09	30.6E-09	30.4E-09	29.7E-09	30.0E-09	31.4E-09	32.7E-09	32.2E-09	30.3E-09	30.2E-09	29.4E-09
7	30.5E-09	30.3E-09	30.7E-09	30.9E-09	31.0E-09	30.3E-09	30.5E-09	32.3E-09	32.8E-09	33.8E-09	30.7E-09	30.5E-09	30.5E-09
14	30.7E-09	30.1E-09	30.7E-09	31.2E-09	30.6E-09	30.0E-09	30.3E-09	31.8E-09	32.3E-09	32.5E-09	30.6E-09	30.3E-09	30.1E-09
Statistics													
Min	30.5E-09	29.8E-09	30.6E-09	30.6E-09	30.4E-09	29.7E-09	30.0E-09	31.4E-09	32.3E-09	32.2E-09	30.3E-09	30.2E-09	29.4E-09
Max	30.7E-09	30.3E-09	30.7E-09	31.2E-09	31.0E-09	30.3E-09	30.5E-09	32.3E-09	32.8E-09	33.8E-09	30.7E-09	30.5E-09	30.5E-09
Average	30.6E-09	30.1E-09	30.6E-09	30.9E-09	30.7E-09	30.0E-09	30.3E-09	31.8E-09	32.6E-09	32.8E-09	30.5E-09	30.3E-09	30.0E-09
Sigma	100.4E-12	195.4E-12	47.2E-12	239.3E-12	225.6E-12	245.1E-12	224.1E-12	387.7E-12	189.2E-12	675.0E-12	160.7E-12	91.1E-12	433.3E-12

**Drift Calculation**

TF_B	0 kRad	10.8 kRad	20.7 kRad	55.6 kRad	102.6 kRad	155.7 kRad	212.4 kRad	268.2 kRad	326.7 kRad	374.2 kRad	416.7 kRad	24 Hours	168 Hours
OFF PROTON samples													
6	-	-794.6E-12	-60.8E-12	-46.4E-12	-198.4E-12	-940.0E-12	-624.4E-12	747.6E-12	2.1E-09	1.6E-09	-315.3E-12	-368.8E-12	-1.2E-09
7	-	-167.8E-12	194.9E-12	398.8E-12	499.1E-12	-183.6E-12	79.9E-12	1.9E-09	2.3E-09	3.3E-09	223.5E-12	5.7E-12	22.7E-12
14	-	-569.4E-12	-45.9E-12	453.6E-12	-111.4E-12	-744.9E-12	-406.4E-12	1.1E-09	1.6E-09	1.8E-09	-129.1E-12	-387.1E-12	-648.1E-12
Average	-	-510.6E-12	29.4E-12	268.7E-12	63.1E-12	-622.8E-12	-317.0E-12	1.2E-09	2.0E-09	2.2E-09	-73.6E-12	-250.1E-12	-604.7E-12
Sigma	-	259.2E-12	117.2E-12	223.9E-12	310.3E-12	320.6E-12	294.4E-12	462.7E-12	278.0E-12	763.2E-12	223.4E-12	181.0E-12	495.5E-12

**Measurements**

TF_B	0 kRad	10.8 kRad	20.7 kRad	55.6 kRad	102.6 kRad	155.7 kRad	212.4 kRad	268.2 kRad	326.7 kRad	374.2 kRad	416.7 kRad	24 Hours	168 Hours
1_REF	30.5E-09	30.0E-09	30.4E-09	29.9E-09	29.7E-09	28.9E-09	28.9E-09	29.9E-09	30.5E-09	30.5E-09	28.5E-09	28.7E-09	28.4E-09
OFF TID samples													
8	30.3E-09	29.7E-09	30.4E-09	30.4E-09	30.3E-09	29.8E-09	30.3E-09	31.5E-09	32.1E-09	32.8E-09	30.7E-09	30.0E-09	30.3E-09
9	30.7E-09	29.9E-09	30.5E-09	30.7E-09	30.5E-09	29.7E-09	30.0E-09	31.2E-09	32.3E-09	32.3E-09	30.3E-09	30.1E-09	30.2E-09
10	30.0E-09	29.9E-09	30.0E-09	30.2E-09	30.2E-09	29.4E-09	29.8E-09	30.8E-09	32.0E-09	31.9E-09	30.2E-09	29.4E-09	30.1E-09
Statistics													
Min	30.0E-09	29.7E-09	30.0E-09	30.2E-09	30.2E-09	29.4E-09	29.8E-09	30.8E-09	32.0E-09	31.9E-09	30.2E-09	29.4E-09	30.1E-09
Max	30.7E-09	29.9E-09	30.5E-09	30.7E-09	30.5E-09	29.8E-09	30.3E-09	31.5E-09	32.3E-09	32.8E-09	30.7E-09	30.1E-09	30.3E-09
Average	30.3E-09	29.8E-09	30.3E-09	30.5E-09	30.3E-09	29.6E-09	30.0E-09	31.2E-09	32.1E-09	32.3E-09	30.4E-09	29.8E-09	30.2E-09
Sigma	289.0E-12	119.8E-12	190.2E-12	221.1E-12	141.8E-12	182.3E-12	228.2E-12	280.8E-12	109.0E-12	355.4E-12	234.0E-12	282.6E-12	67.9E-12

**Drift Calculation**

TF_B	0 kRad	10.8 kRad	20.7 kRad	55.6 kRad	102.6 kRad	155.7 kRad	212.4 kRad	268.2 kRad	326.7 kRad	374.2 kRad	416.7 kRad	24 Hours	168 Hours
OFF TID samples													
8	-	-588.4E-12	98.1E-12	168.0E-12	49.7E-12	-435.2E-12	49.5E-12	1.2E-09	1.9E-09	2.5E-09	435.9E-12	-285.8E-12	6.4E-12
9	-	-775.4E-12	-245.1E-12	23.2E-12	-190.6E-12	-1.0E-09	-695.7E-12	509.1E-12	1.6E-09	1.6E-09	-442.3E-12	-626.0E-12	-517.1E-12
10	-	-105.6E-12	5.1E-12	180.9E-12	163.0E-12	-624.6E-12	-265.8E-12	808.6E-12	2.0E-09	1.9E-09	133.7E-12	-576.8E-12	84.4E-12
Average	-	-489.8E-12	-47.3E-12	124.0E-12	7.4E-12	-690.3E-12	-304.0E-12	855.8E-12	1.8E-09	2.0E-09	42.4E-12	-496.2E-12	-142.1E-12
Sigma	-	282.2E-12	144.9E-12	71.5E-12	147.4E-12	239.7E-12	305.4E-12	304.2E-12	180.1E-12	401.7E-12	364.3E-12	150.1E-12	267.1E-12