

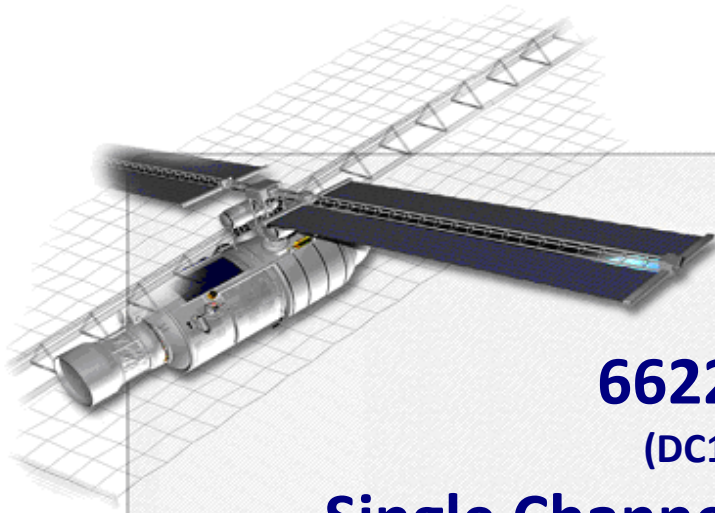

# NEUTRONS DISPLACEMENT DAMAGE TEST REPORT



## 66221-103 (DC1122) Single Channel Optocoupler From MICROPAC

TRAD/TN/66221/XXX1/ESA/YP/1104		Labège, March 2nd, 2012	
 		TRAD, Bât Gallium 907, Voie l'Occitane - 31670 LABEGE France ☎ : 05 61 00 95 60 Fax : 05 61 00 95 61 Email : <a href="mailto:trad@trad.fr">trad@trad.fr</a> Web Site: <a href="http://www.trad.fr">www.trad.fr</a>  SIRET 397 862 038 00056 - TVA FR59397862038	
Written by	Verified by / Quality control	Approved by	
A. SAMARAS 20/02/2012	M.SAUVAGNAC/Y.PADIE 02/03/2012	C.CHATRY 02/03/2012	
Issue : 0			
To: Marc POIZAT	Project/Program :	ESA Contract N°4000102571/10/NL/AF-Radiation Characterization of Laplace RH optocouplers, sensors and detectors	

## TABLE OF CONTENT

<b>1</b>	<b>INTRODUCTION .....</b>	<b>3</b>
<b>2</b>	<b>DOCUMENTS .....</b>	<b>3</b>
2.1	Applicable Documents .....	3
2.2	Reference Documents.....	3
<b>3</b>	<b>DEVICE INFORMATION.....</b>	<b>3</b>
3.1	Device description.....	3
3.2	Procurement information.....	4
3.3	External view.....	4
3.4	Internal view .....	4
3.5	Serialization.....	5
<b>4</b>	<b>IRRADIATION MEANS AND CONDITIONS .....</b>	<b>6</b>
4.1	BR1 irradiation facility (Belgium) .....	6
4.2	Dose measurement.....	6
4.3	Experimental conditions .....	6
4.4	Exposure set-up .....	6
<b>5</b>	<b>ELECTRICAL TESTS.....</b>	<b>7</b>
5.1	Test set-up .....	7
5.2	Electrical parameters .....	8
<b>6</b>	<b>TEST HISTORY .....</b>	<b>8</b>
<b>7</b>	<b>SUMMARY RESULTS.....</b>	<b>9</b>
<b>8</b>	<b>CONCLUSION .....</b>	<b>10</b>
<b>9</b>	<b>DETAILED TESTS RESULTS.....</b>	<b>11</b>

## LIST OF FIGURES

Figure 1:	package marking.....	4
Figure 2:	package back.....	4
Figure 3:	Internal general view .....	4
Figure 4:	transistor die view.....	4
Figure 5:	photodetector and LED view .....	5
Figure 6:	schematical view of the large cavity and its spherical drivers .....	6
Figure 7:	view of the sample holder.....	6
Figure 8:	test principle .....	7

## 1 INTRODUCTION

This report includes the test results of 66221-103, a Single Channel Optocoupler from MICROPAC to evaluate displacement damage effects under neutron irradiation. On November, week 45, 2011, TRAD characterized this device for neutron sensitivity at the SCK-CEN Facility, Belgium using their BR1 Neutron Irradiator.

The objectives of the test are:

- to detect and measure the degradation of device parameters as a function of neutron fluence,
- to determine if device parameters are within specified limits after exposure to final level of neutron fluence.

## 2 DOCUMENTS

### 2.1 Applicable Documents

AD	1.	ESA contract	N°4000102571/10/NL/AF-Radiation Characterization of Laplace RH optocouplers, sensors and detectors
AD	2.	Irradiation Test Plan	ITP_TN_66221_MIC_ESA_1119, Iss.2, 27/06/11

### 2.2 Reference Documents

RD	3.	Datasheet 66221 by MICROPAC	PROTON RADIATION TOLERANT OPTOCOUPLER dated 31/03/2011
RD	4.	MICROPAC certificate of traceability and conformance dated 25/07/2011	

## 3 DEVICE INFORMATION

### 3.1 Device description

The 66221-103 is a single channel device electrically similar to the 4N49. It contains an 850nm LED optically coupled to a silicon planar "40 x40" phototransistor. This product has been designed to be more tolerant to proton radiation. The 66221 optocoupler is packaged in a hermetically sealed 6 pin leadless chip carrier (LCC).

Type	66221-103
Manufacturer	MICROPAC
Function	Optocoupler
Package	LCC6
Date Code	1122
Sample size	4 parts (3 test parts + 1 control sample)

### 3.2 Procurement information

75 parts reference 66221-103 were delivered by MICROPAC through the French distributor ISOTOPE ELECTRONICS.

Their quality level defined by the 103 extension number corresponds to a commercial standard operating in the temperature range of -55° to +125°C and screened to TX level by the manufacturer prior delivery. One single lot of 75 parts, date-code 1122, was delivered together with a Certificate of Conformance [RD2].

### 3.3 External view



Figure 1: package marking

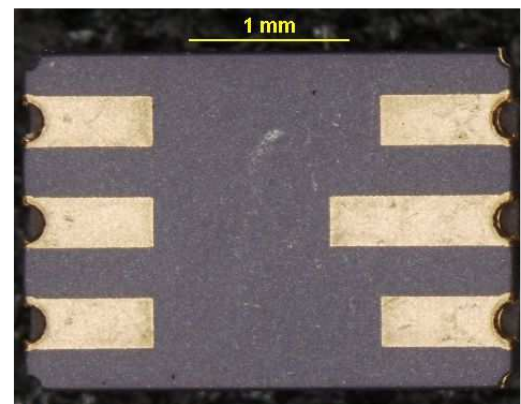

Figure 2: package back

### 3.4 Internal view

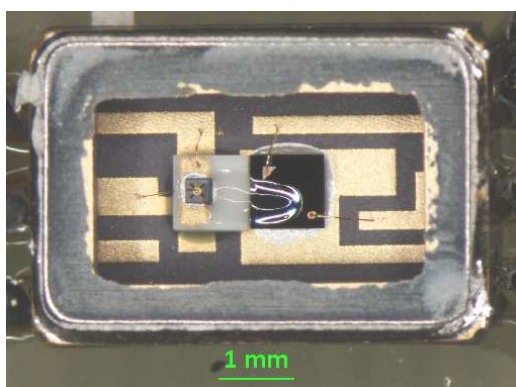

Figure 3: Internal general view

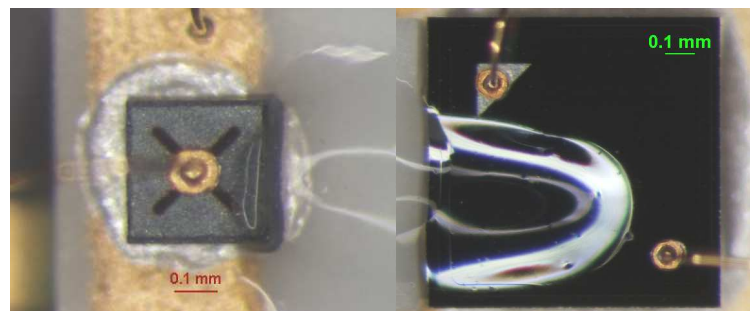

Figure 4: transistor die view

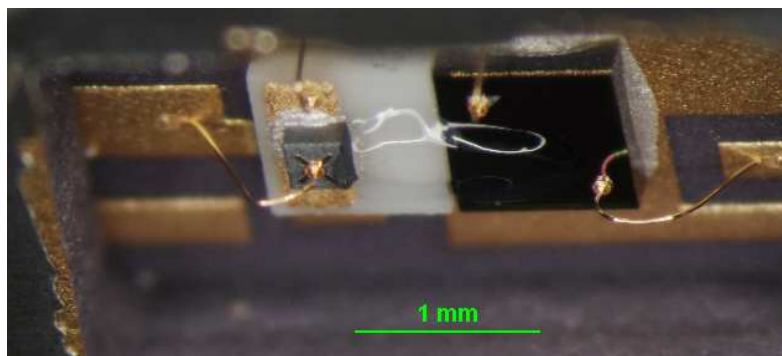

Figure 5: photodetector and LED view

### 3.5 Serialization

Each part is serialized to enable pre and post test identification and comparison.

Serial Number	Control sample	Test samples		
Serialization	1	2	3	4

## 4 IRRADIATION MEANS AND CONDITIONS

### 4.1 BR1 irradiation facility (Belgium)

The Reactor BR1 is a versatile neutron / gamma irradiation tool. The large cavity is used for this test. To obtain the required neutron flux, a 6cm Uranium shell is used. This spherical converter provides a 1 MeV equivalent neutron flux of  $2.86E+08n/cm^2.s$ , with a low ionizing dose rate of 2,5Gy/h.

All exposures are made at  $20^{\circ}C \pm 10^{\circ}C$ .

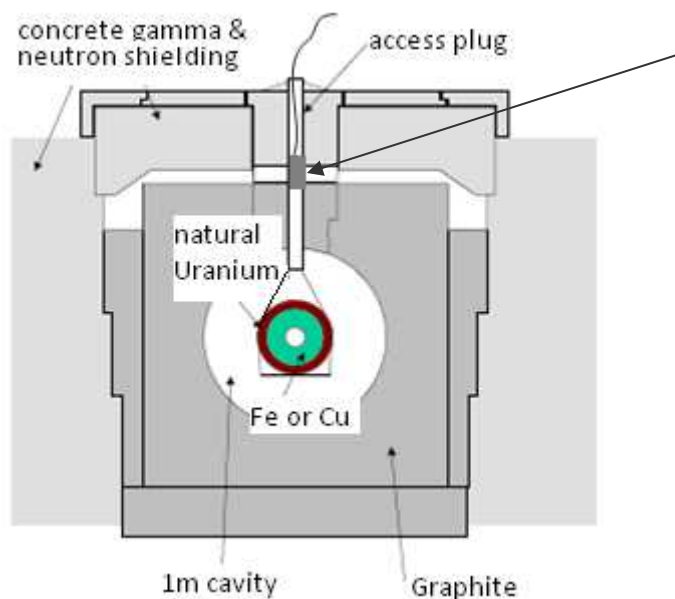
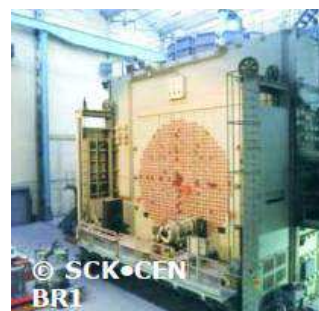

Figure 6: schematical view of the large cavity and its spherical drivers

The sample holder is a cylinder, dimensions of which are 3.5 cm diameter and 5.5 cm length made of high-density polyethylene.



Figure 7: view of the sample holder

### 4.2 Dose measurement

The SCK•CEN reactor dosimetry service is accredited by BELAC (Ministry of Economic Affairs from Belgium) under the accreditation number 015-TEST. The accreditation towards norms NBN EN ISO/IEC 17025 for the Standard Practice for Determining Neutron Fluence Rate, Fluence, and Spectra by Radioactivation Techniques (ASTM261 & ASTM262) is in progress.

### 4.3 Experimental conditions

An Equivalent total fluence of  $1E12 \text{ \#/cm}^2$  of 10 MeV protons is required [AD2] for this TNID (Total Non Ionizing Dose) evaluation test. Considering NIEL (Non Ionizing Energy Loss) value for 1 MeV neutron ( $1.14E-03 \text{ MeV cm}^2 \text{ g}^{-1}$ ), it corresponds to a total fluence of  $6.89E+12 \text{ \#/cm}^2$  for 1 MeV neutron.

Five steps are defined to determine the component degradation under 1 MeV neutron irradiation. The test devices have been exposed to the following neutron fluence levels:

	Step1	Step2	Step3	Step4	Step5
Fluence $n/cm^2$	5,00E+10	1,00E+11	5,00E+11	1,00E+12	7,00E+12
Flux $n/cm^2.s$	2,86E+08	2,86E+08	2,86E+08	2,86E+08	2,86E+08

### 4.4 Exposure set-up

The samples were exposed to neutron irradiation in an un-biased state and had all their terminal leads open.

## 5 ELECTRICAL TESTS

Electrical parameters to be measured in pre and post exposure tests are described in the following table. Electrical tests are performed on each part using the test set-up hereunder. All required data are recorded for each device. Test conditions and limits are given in the applicable irradiation test plan [AD2] and shown hereafter.

### 5.1 Test set-up

TEST BOARD	TRAD/CT1/N/OPTO/ZIP14/BR/1109
TEST PROGRAM	66221_TN_XXX1_B1_V10.Ilb

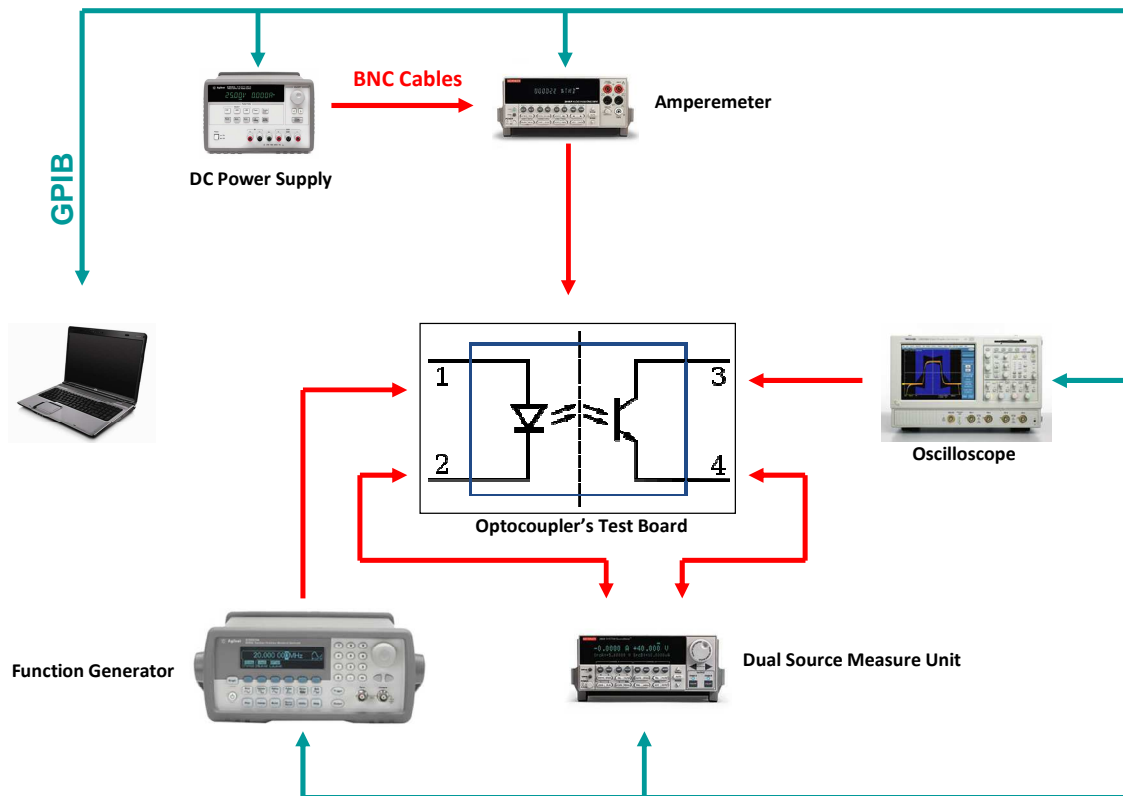

Figure 8: test principle

## 5.2 Electrical parameters

PARAMETER	SYMBOL	TEST CONDITION	MIN	MAX	UNIT
Input Diode Static Reverse Current	$I_R$	$V_R = 6\text{ V}$		8	$\mu\text{A}$
Input Diode Static Forward Voltage	$V_F$	$I_F = 10\text{ mA}$		1,6	V
Collector-Base Breakdown Voltage	$V_{(BR)CBO}$	$I_C = 100\ \mu\text{A}, I_B = 0, I_F = 0$	60		V
Collector-Emitter Breakdown Voltage	$V_{(BR)CEO}$	$I_C = 1\text{ mA}, I_B = 0, I_F = 0$	60		V
Emitter-Collector Breakdown Voltage	$V_{(BR)ECO}$	$I_C = 0\text{ mA}, I_E = 100\ \mu\text{A}, I_F = 0$	7		V
Off-State Collector Current	$I_{CEO}$	$V_{CE} = 20\text{ V}, I_F = 0\text{ mA}, I_B = 0$		100	nA
On State Collector Current	$I_{C(ON)}$	$V_{CE} = 5\text{ V}, I_F = 1\text{ mA}, I_B = 0^*$	2	10	mA
Rise Time- Phototransistor Operation	tr1	$V_{CC} = 10\text{V}, I_F = 5\text{mA}, R_L = 100\Omega, I_B = 0$		25	$\mu\text{s}$
Fall Time-Phototransistor Operation	tf1	$V_{CC} = 10\text{V}, I_F = 5\text{mA}, R_L = 100\Omega, I_B = 0$		25	$\mu\text{s}$
Rise Time-Photodiode Operation	tr2	$V_{CC} = 10\text{V}, I_F = 5\text{mA}, R_L = 100\Omega, I_E = 0$		3	$\mu\text{s}$
Fall Time-Photodiode Operation	tf2	$V_{CC} = 10\text{V}, I_F = 5\text{mA}, R_L = 100\Omega, I_E = 0$		3	$\mu\text{s}$
Current Transfer Ratio	CTR1	$V_{CE} = 5\text{V}, I_F = 1\text{mA}$			%
	CTR2	$V_{CE} = 5\text{V}, I_F = 2\text{mA}$			%
	CTR3	$V_{CE} = 5\text{V}, I_F = 10\text{mA}$			%
	CTR4	$V_{CE} = 5\text{V}, I_F = 50\text{mA}$			%
	CTR5	$V_{CE} = 30\text{V}, I_F = 10\text{mA}$			%
Input Diode Reverse Recovery Time	Trr	$I_f = 5\text{mA}, R_L = 100\text{ Ohms}, I_{rec} = 10\% I_{rm}$			ns

(\*)This parameter must be measured using pulse techniques ( $t_W = 100\ \mu\text{s}$  duty cycle < 1%).

Min/ Max values are those specified in the reference data-sheet [RD1].

Test measurements are performed at  $20^\circ\text{C} \pm 10^\circ\text{C}$ .

## 6 TEST HISTORY

Test sequence and all required conditions were executed as described in the test plan.  
No incident during the test was noticed.



## 7 SUMMARY RESULTS

Only parameters with applicable test limits are shown hereunder.

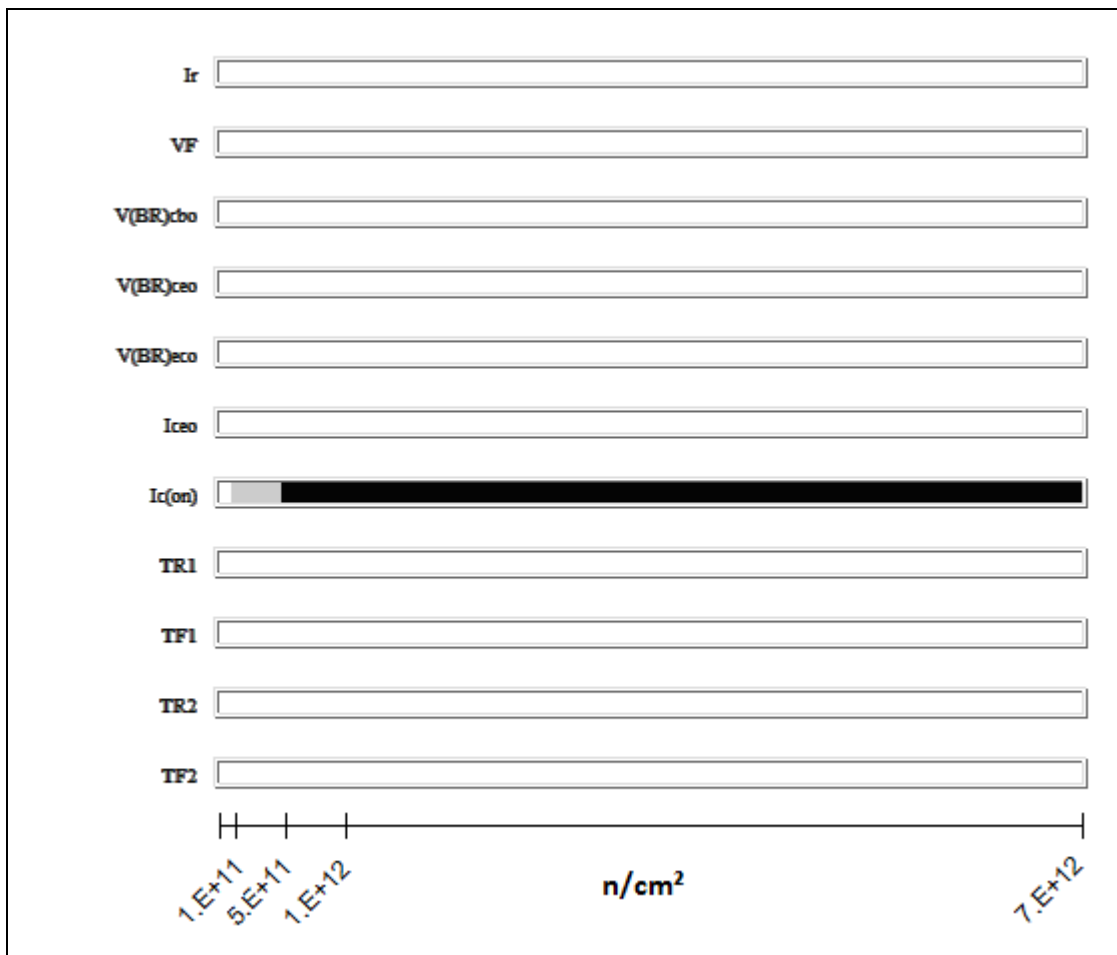

- Within specification
- Transition
- Out of specification or parameter not measurable

In the worst case, the parameter  $I_c(on)$  is out of specification at  $4.55E11.n/cm^2$  by interpolation. The next table shows the value of  $I_c(on)$  out of specification for each tested component at the corresponding irradiation step.

	Device N°2 at step 5E11n/cm <sup>2</sup>	Device N°3 at step 5E11n/cm <sup>2</sup>	Device N°4 at step 1E12n/cm <sup>2</sup>	Applicable specification
$I_c(on)$	1.87 mA	1.852 mA	1.34 mA	MIN : 2 mA

## 8 CONCLUSION

Total fluence steady-state irradiation test using neutrons has been applied on three devices type 66221-103, a Single Channel Optocoupler from MICROPAC up to  $7E+12$  neutrons/cm<sup>2</sup>, with an energy of 1 MeV.

The results show that:

- For the three devices tested,  $I_{C(ON)}$  parameter at step  $5E11$  n/cm<sup>2</sup> is out of specification.

PARAMETERS	SYMBOLS	TEST CONDITIONS	Applicable specification			Worst value at step $1E12$ n/cm <sup>2</sup>
			Min	Max	Unit	
On State Collector Current	$I_{C(ON)}$	$V_{CE} = 5 V, I_F = 1 mA, I_B = 0$	2		mA	1.34 mA

Nevertheless, all devices are functional up to  $1 E+12$  neutrons/cm<sup>2</sup> total fluence level.

- Average drift current transfer ratio are described in the next table for each irradiation step and CTR configuration

PARAMETERS	SYMBOL	UNIT	STEP IRRADIATION					
			0E10 n/cm <sup>2</sup>	5E10 n/cm <sup>2</sup>	1E11 n/cm <sup>2</sup>	5E11 n/cm <sup>2</sup>	1E12 n/cm <sup>2</sup>	7E12 n/cm <sup>2</sup>
Average drift Current Transfer Ratio	$\overline{\Delta CTR1}$	%	0.00E+00	1.37E-04	3.62E-04	2.41E-03	5.62E-03	1.55E-01
	$\overline{\Delta CTR2}$	%	0.00E+00	1.09E-04	2.43E-04	1.47E-03	3.36E-03	9.09E-02
	$\overline{\Delta CTR3}$	%	0.00E+00	-2.11E-06	2.88E-05	2.49E-04	7.05E-04	2.71E-02
	$\overline{\Delta CTR4}$	%	0.00E+00	-3.71E-07	7.98E-05	5.58E-04	1.10E-03	6.86E-03
	$\overline{\Delta CTR5}$	%	0.00E+00	5.23E-09	1.59E-05	1.61E-04	4.36E-04	1.31E-02

- The CTR5 configuration ( $V_{CE} = 5V, I_F = 50mA$ ) is the least sensitive configuration up to a fluence of  $1E12n/cm^2$ .
- The CTR4 configuration ( $V_{CE} = 30V, I_F = 10mA$ ) exhibits the smallest average parameter drift at the final irradiation step  $7E12n/cm^2$ .
- Conversely, the CRT1 configuration ( $V_{CE} = 5V, I_F = 1mA$ ) exhibits the greatest parameter degradation at all steps.

## 9 DETAILED TESTS RESULTS

The pre and post radiation test results are shown graphically in the following pages (9-2 to 9-18). The data is displayed in the following tables and graphs.

These graphs show parameter's shifts observed during the neutron testing sequence. The Control sample results are shown on each graph (black curve).

When available in the device data-sheet/specification, the maximum/minimum/typical values are also shown (red dotted line).

The tables include drift calculation between each measurement step and the "0" neutrons/cm<sup>2</sup> step.

For CTR values, the formula used is:

$$\text{Drift} = \frac{1}{\text{measurement (X neutrons /cm}^2)} - \frac{1}{\text{measurement (0 neutrons /cm}^2)}$$

For the other measurements the formula used is:

$$\text{Drift value} = \text{measurement (X neutrons/cm}^2) - \text{measurement (0 neutrons/cm}^2)$$

## CONTENTS

1.	Ir.....	2
2.	VF .....	3
3.	V(BR)cbo.....	4
4.	V(BR)ceo.....	5
5.	V(BR)eco.....	6
6.	Iceo.....	7
7.	Ic(on) .....	8
8.	TR1 .....	9
9.	TF1.....	10
10.	TR2 .....	11
11.	TF2.....	12
12.	CTR1 .....	13
13.	CTR2 .....	14
14.	CTR3 .....	15
15.	CTR4 .....	16
16.	CTR5 .....	17
17.	TRR.....	18

## 1. Ir

Ta=20°C; VR=6V

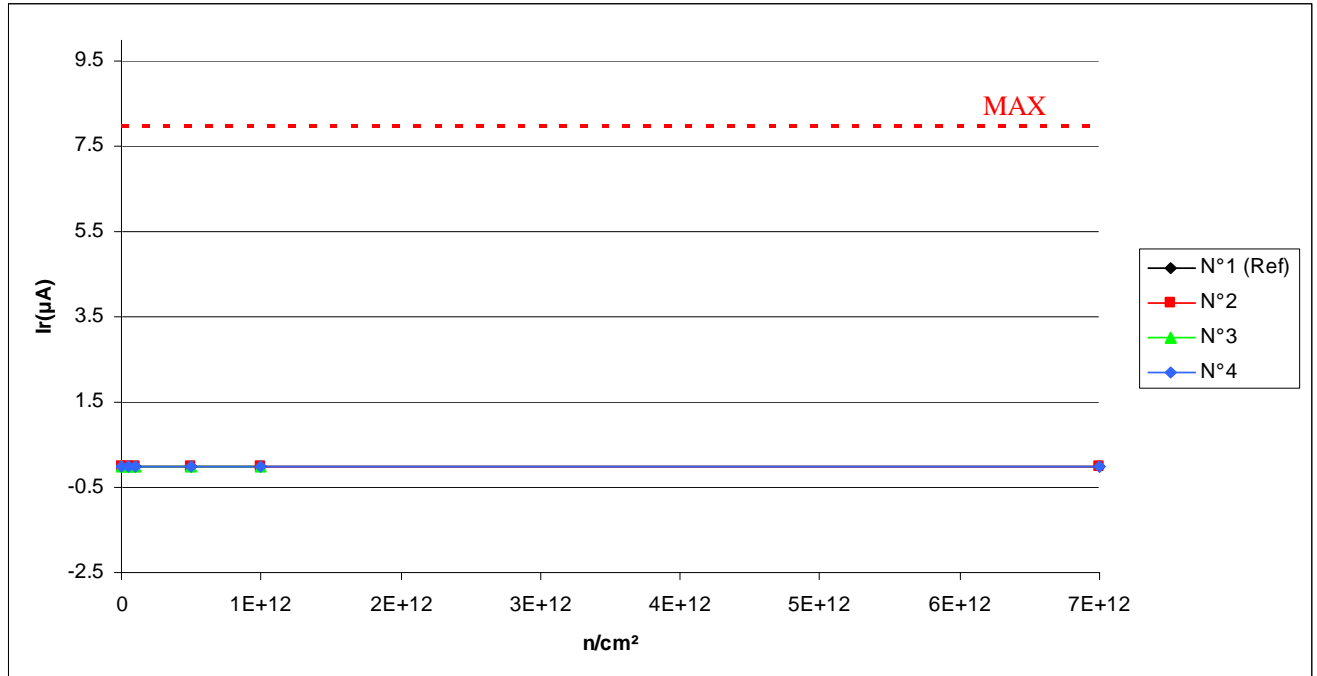

Ir. (µA) Max = 8.0

	0.n/cm²	5E10.n/cm²	1E11.n/cm²	5E11.n/cm²	1E12.n/cm²	7E12.n/cm²
N° 1 (Ref)	7.974E-5	9.512E-5	8.573E-5	1.509E-4	8.686E-5	6.440E-5
N° 2	2.589E-5	1.038E-4	7.232E-5	1.183E-4	1.644E-4	1.392E-4
N° 3	1.776E-5	9.860E-5	7.990E-5	1.304E-4	1.496E-4	2.218E-4
N° 4	3.050E-5	9.516E-5	8.552E-5	1.317E-4	1.395E-4	1.929E-4

Delta [Ir]

	0.n/cm²	5E10.n/cm²	1E11.n/cm²	5E11.n/cm²	1E12.n/cm²	7E12.n/cm²
N° 1 (Ref)	---	1.538E-5	5.990E-6	7.117E-5	7.122E-6	-1.534E-5
N° 2	---	7.795E-5	4.643E-5	9.245E-5	1.385E-4	1.133E-4
N° 3	---	8.084E-5	6.215E-5	1.126E-4	1.319E-4	2.041E-4
N° 4	---	6.466E-5	5.502E-5	1.012E-4	1.090E-4	1.625E-4
Average	---	7.448E-5	5.453E-5	1.021E-4	1.264E-4	1.599E-4
σ	---	8.627E-6	7.869E-6	1.011E-5	1.546E-5	4.545E-5
Average+3σ	---	1.004E-4	7.814E-5	1.324E-4	1.728E-4	2.963E-4
Average-3σ	---	4.860E-5	3.093E-5	7.177E-5	8.007E-5	2.360E-5

## 2. VF

Ta=20°C; If=10mA

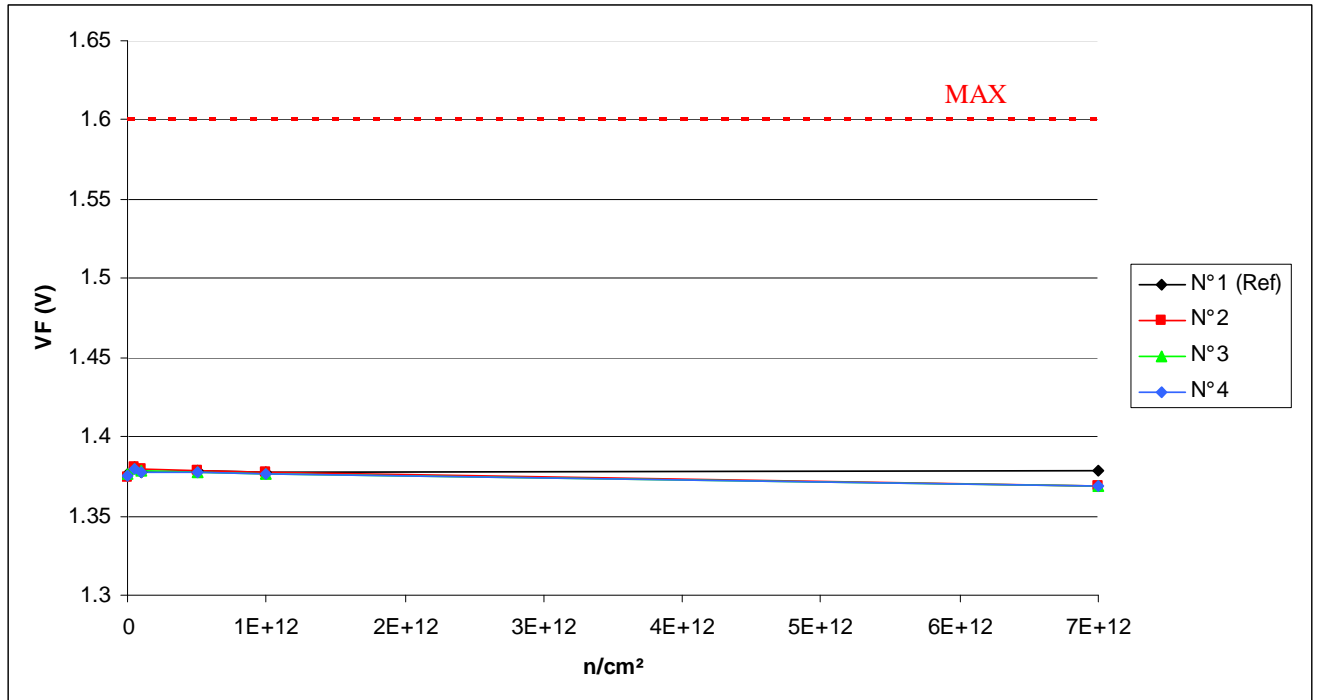

VF. (V)

Max = 1.6

	0.n/cm²	5E10.n/cm²	1E11.n/cm²	5E11.n/cm²	1E12.n/cm²	7E12.n/cm²
N° 1 (Ref)	1.376	1.381	1.378	1.379	1.378	1.379
N° 2	1.374	1.381	1.380	1.379	1.378	1.369
N° 3	1.376	1.380	1.379	1.378	1.377	1.369
N° 4	1.375	1.380	1.378	1.378	1.377	1.369

Delta [VF]

	0.n/cm²	5E10.n/cm²	1E11.n/cm²	5E11.n/cm²	1E12.n/cm²	7E12.n/cm²
N° 1 (Ref)	---	5.268E-3	2.615E-3	3.703E-3	2.226E-3	3.102E-3
N° 2	---	7.036E-3	5.534E-3	4.994E-3	4.061E-3	-5.099E-3
N° 3	---	4.485E-3	2.983E-3	2.440E-3	1.121E-3	-6.630E-3
N° 4	---	4.989E-3	3.663E-3	3.493E-3	1.966E-3	-6.146E-3
Average	---	5.503E-3	4.060E-3	3.642E-3	2.383E-3	-5.958E-3
σ	---	1.351E-3	1.321E-3	1.284E-3	1.514E-3	7.826E-4
Average+3σ	---	9.556E-3	8.023E-3	7.493E-3	6.924E-3	-3.611E-3
Average-3σ	---	1.450E-3	9.693E-5	-2.083E-4	-2.158E-3	-8.306E-3

### 3. V(BR)cbo

Ta=20°C; Ic=100μA; Ib=0; If=0

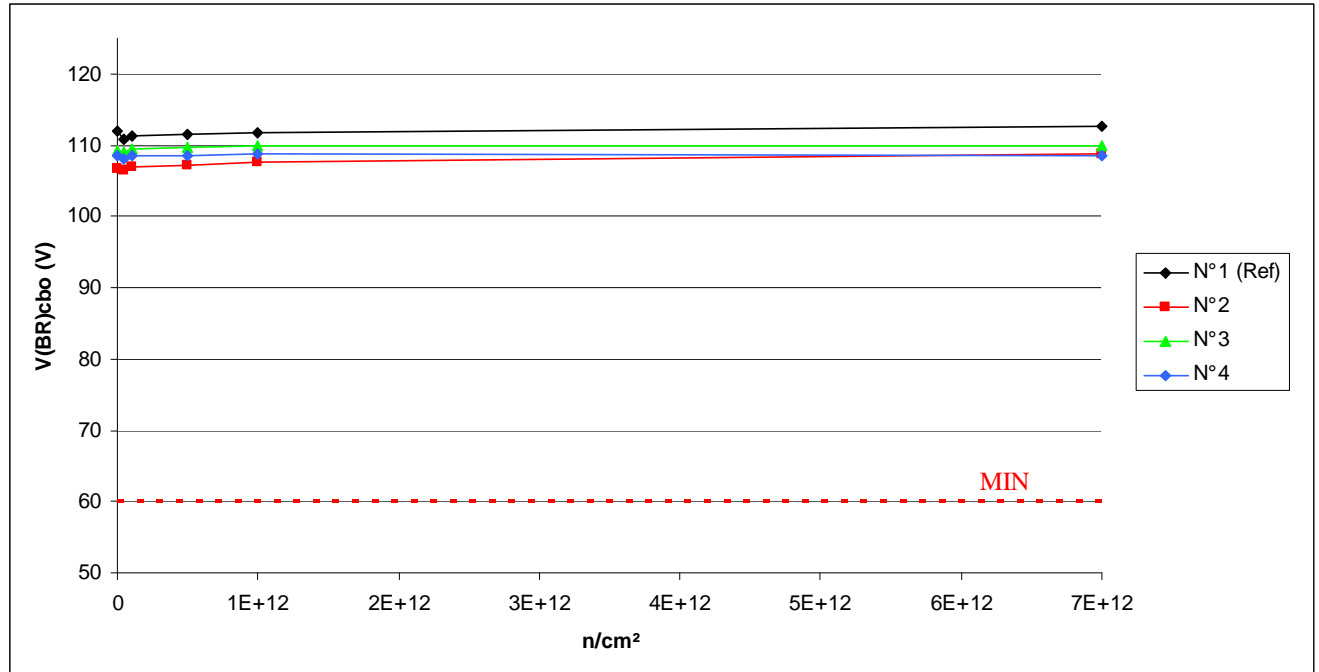

V(BR)cbo . (V)

Min = 60.0

	0.n/cm²	5E10.n/cm²	1E11.n/cm²	5E11.n/cm²	1E12.n/cm²	7E12.n/cm²
N° 1 (Ref)	111.896	110.914	111.366	111.446	111.684	112.603
N° 2	106.791	106.459	106.991	107.209	107.581	108.770
N° 3	109.308	109.099	109.492	109.736	109.966	109.969
N° 4	108.439	108.118	108.531	108.570	108.870	108.628

Delta [V(BR)cbo]

	0.n/cm²	5E10.n/cm²	1E11.n/cm²	5E11.n/cm²	1E12.n/cm²	7E12.n/cm²
N° 1 (Ref)	---	-9.822E-1	-5.305E-1	-4.503E-1	-2.122E-1	7.068E-1
N° 2	---	-3.320E-1	2.002E-1	4.178E-1	7.904E-1	1.979E+0
N° 3	---	-2.087E-1	1.843E-1	4.281E-1	6.579E-1	6.608E-1
N° 4	---	-3.210E-1	9.230E-2	1.311E-1	4.307E-1	1.889E-1
Average	---	-2.872E-1	1.589E-1	3.257E-1	6.263E-1	9.430E-1
σ	---	6.823E-2	5.825E-2	1.686E-1	1.819E-1	9.280E-1
Average+3σ	---	-8.253E-2	3.337E-1	8.314E-1	1.172E+0	3.727E+0
Average-3σ	---	-4.919E-1	-1.582E-2	-1.801E-1	8.059E-2	-1.841E+0

#### 4. V(BR)ceo

Ta=20°C; Ic=1mA; Ib=0; If=0

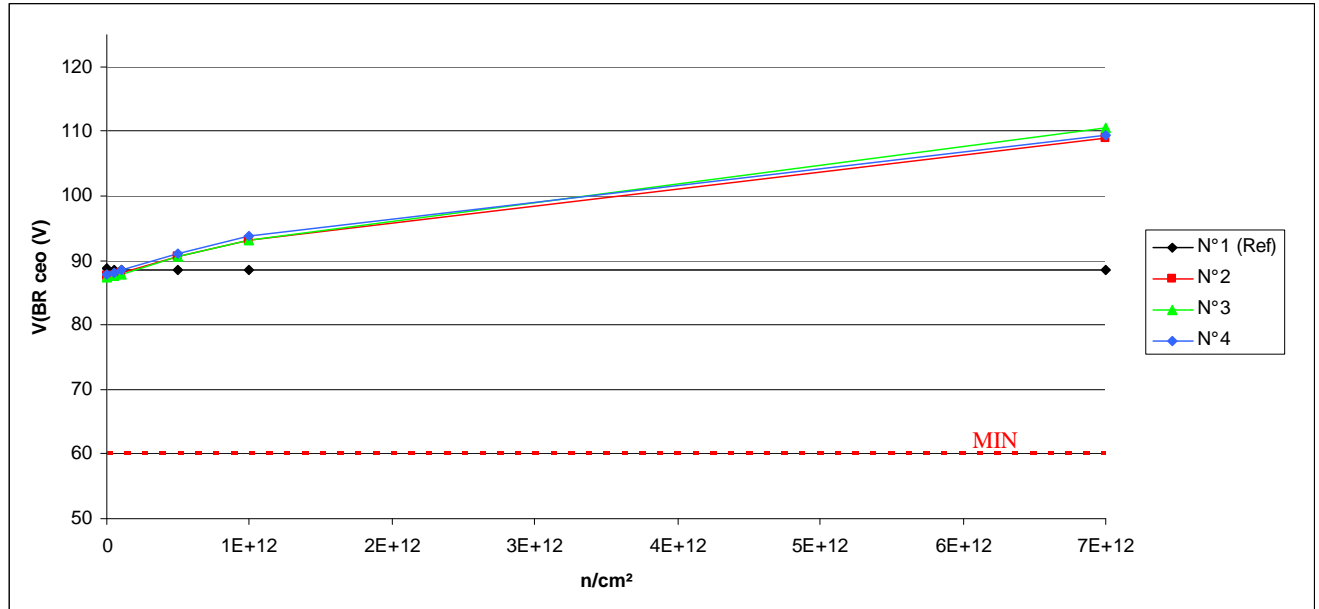

#### V(BR)ceo . (V)

Min = 60.0

	0.n/cm²	5E10.n/cm²	1E11.n/cm²	5E11.n/cm²	1E12.n/cm²	7E12.n/cm²
N° 1 (Ref)	88.705	88.594	88.632	88.598	88.645	88.629
N° 2	87.553	87.712	88.045	90.549	93.188	109.006
N° 3	87.376	87.602	87.928	90.515	93.040	110.493
N° 4	87.926	88.125	88.490	91.067	93.754	109.299

#### Delta [V(BR)ceo]

	0.n/cm²	5E10.n/cm²	1E11.n/cm²	5E11.n/cm²	1E12.n/cm²	7E12.n/cm²
N° 1 (Ref)	---	-1.114E-1	-7.337E-2	-1.072E-1	-6.071E-2	-7.639E-2
N° 2	---	1.588E-1	4.912E-1	2.996E+0	5.634E+0	2.145E+1
N° 3	---	2.262E-1	5.521E-1	3.139E+0	5.664E+0	2.312E+1
N° 4	---	1.992E-1	5.637E-1	3.141E+0	5.828E+0	2.137E+1
Average	---	1.947E-1	5.357E-1	3.092E+0	5.709E+0	2.198E+1
σ	---	3.393E-2	3.893E-2	8.330E-2	1.042E-1	9.851E-1
Average+3σ	---	2.965E-1	6.525E-1	3.342E+0	6.022E+0	2.494E+1
Average-3σ	---	9.294E-2	4.189E-1	2.842E+0	5.396E+0	1.903E+1



## 5. V(BR)eco

Ta=20°C; Ic=0; Ie=100µA; If=0

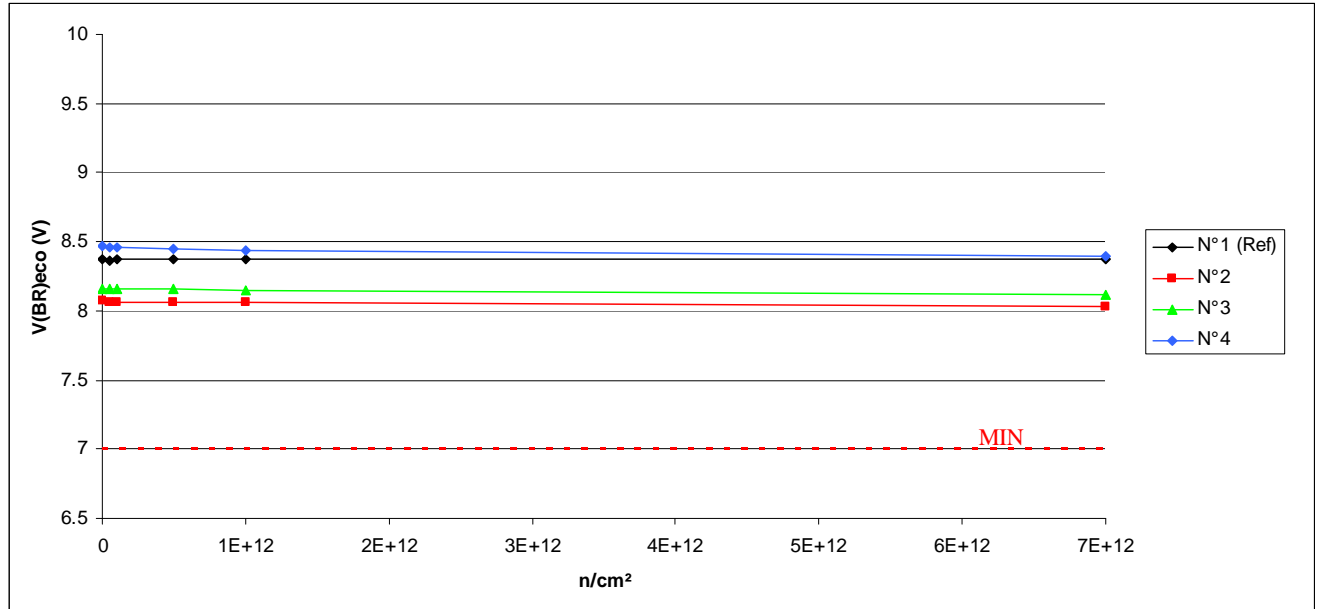

V(BR)eco . (V)

Min = 7.0

	0.n/cm²	5E10.n/cm²	1E11.n/cm²	5E11.n/cm²	1E12.n/cm²	7E12.n/cm²
N° 1 (Ref)	8.372	8.366	8.369	8.368	8.370	8.371
N° 2	8.073	8.066	8.067	8.064	8.059	8.034
N° 3	8.158	8.154	8.155	8.154	8.150	8.114
N° 4	8.472	8.464	8.464	8.448	8.435	8.391

Delta [V(BR)eco]

	0.n/cm²	5E10.n/cm²	1E11.n/cm²	5E11.n/cm²	1E12.n/cm²	7E12.n/cm²
N° 1 (Ref)	---	-6.213E-3	-3.235E-3	-4.372E-3	-2.275E-3	-1.683E-3
N° 2	---	-6.980E-3	-6.123E-3	-9.363E-3	-1.472E-2	-3.909E-2
N° 3	---	-4.425E-3	-2.988E-3	-4.620E-3	-8.531E-3	-4.405E-2
N° 4	---	-8.271E-3	-8.350E-3	-2.386E-2	-3.671E-2	-8.141E-2
Average	---	-6.559E-3	-5.820E-3	-1.262E-2	-1.999E-2	-5.485E-2
σ	---	1.957E-3	2.694E-3	1.002E-2	1.481E-2	2.314E-2
Average+3σ	---	-6.867E-4	2.261E-3	1.746E-2	2.444E-2	1.455E-2
Average-3σ	---	-1.243E-2	-1.390E-2	-4.269E-2	-6.441E-2	-1.243E-1

## 6. Iceo

Ta=20°C; Vce=20V; If=0; Ib=0

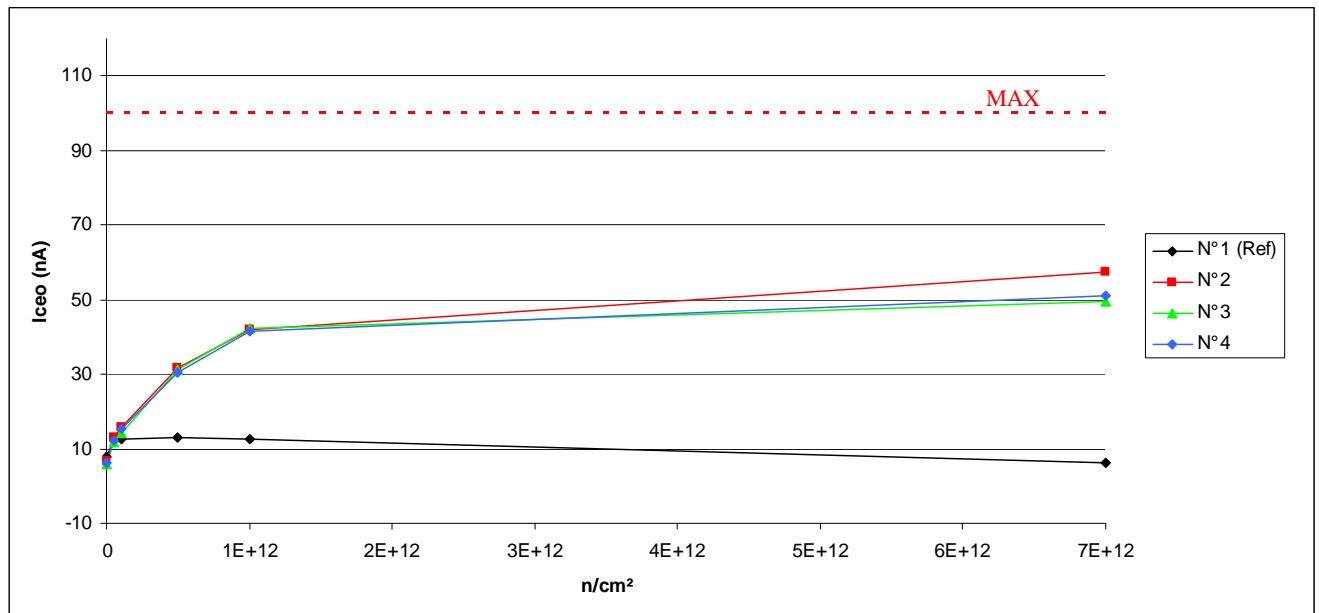

Iceo . (nA)

Max = 100.0

	0.n/cm²	5E10.n/cm²	1E11.n/cm²	5E11.n/cm²	1E12.n/cm²	7E12.n/cm²
N° 1 (Ref)	7.915	12.393	12.675	13.059	12.530	6.428
N° 2	6.808	12.906	15.682	31.788	42.006	57.543
N° 3	5.720	11.622	14.226	31.063	42.166	49.503
N° 4	6.278	12.014	15.389	30.529	41.506	51.004

Delta [Iceo]

	0.n/cm²	5E10.n/cm²	1E11.n/cm²	5E11.n/cm²	1E12.n/cm²	7E12.n/cm²
N° 1 (Ref)	---	4.479E+0	4.760E+0	5.144E+0	4.615E+0	-1.486E+0
N° 2	---	6.098E+0	8.874E+0	2.498E+1	3.520E+1	5.074E+1
N° 3	---	5.903E+0	8.506E+0	2.534E+1	3.645E+1	4.378E+1
N° 4	---	5.736E+0	9.111E+0	2.425E+1	3.523E+1	4.473E+1
Average	---	5.912E+0	8.830E+0	2.486E+1	3.562E+1	4.641E+1
σ	---	1.814E-1	3.050E-1	5.565E-1	7.124E-1	3.771E+0
Average+3σ	---	6.456E+0	9.745E+0	2.653E+1	3.776E+1	5.773E+1
Average-3σ	---	5.368E+0	7.915E+0	2.319E+1	3.349E+1	3.510E+1

## 7. Ic(on)

Ta=20°C; Vce=5V; If=1mA; Ib=0

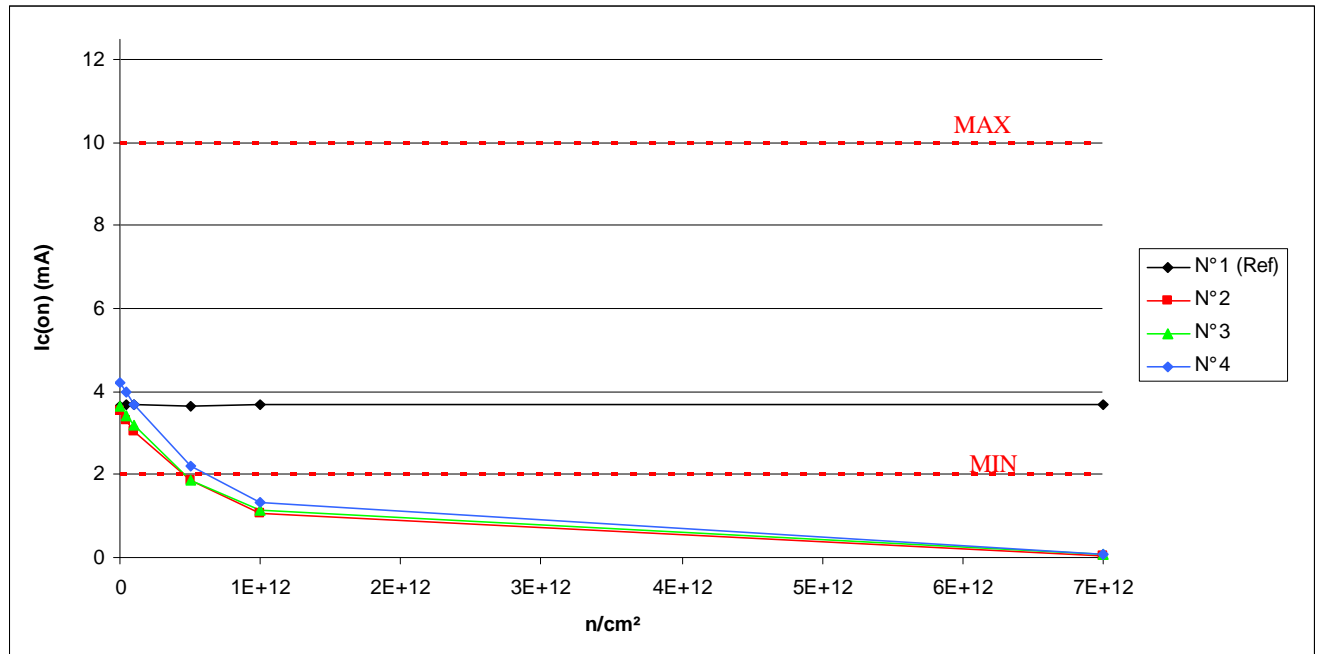

Ic(on) . (mA) **Min = 2.0 Max = 10.0**

	0.n/cm <sup>2</sup>	5E10.n/cm <sup>2</sup>	1E11.n/cm <sup>2</sup>	5E11.n/cm <sup>2</sup>	1E12.n/cm <sup>2</sup>	7E12.n/cm <sup>2</sup>
N° 1 (Ref)	3.639	3.681	3.668	3.655	3.672	3.669
N° 2	3.523	3.293	3.032	1.870	1.052	0.056
N° 3	3.664	3.427	3.174	1.852	1.142	0.058
N° 4	4.232	3.978	3.695	2.203	1.340	0.069

**Delta [Ic(on)]**

	0.n/cm <sup>2</sup>	5E10.n/cm <sup>2</sup>	1E11.n/cm <sup>2</sup>	5E11.n/cm <sup>2</sup>	1E12.n/cm <sup>2</sup>	7E12.n/cm <sup>2</sup>
N° 1 (Ref)	---	4.125E-2	2.896E-2	1.544E-2	3.302E-2	2.931E-2
N° 2	---	-2.291E-1	-4.904E-1	-1.653E+0	-2.471E+0	-3.467E+0
N° 3	---	-2.368E-1	-4.897E-1	-1.812E+0	-2.522E+0	-3.606E+0
N° 4	---	-2.541E-1	-5.373E-1	-2.029E+0	-2.892E+0	-4.164E+0
Average	---	-2.400E-1	-5.058E-1	-1.831E+0	-2.628E+0	-3.745E+0
σ	---	1.282E-2	2.728E-2	1.890E-1	2.300E-1	3.689E-1
Average+3σ	---	-2.015E-1	-4.240E-1	-1.264E+0	-1.938E+0	-2.639E+0
Average-3σ	---	-2.784E-1	-5.876E-1	-2.398E+0	-3.318E+0	-4.852E+0

## 8. TR1

Ta=20°C; Vcc=10V; If=5mA; RL=100 Ohms; Ib=0

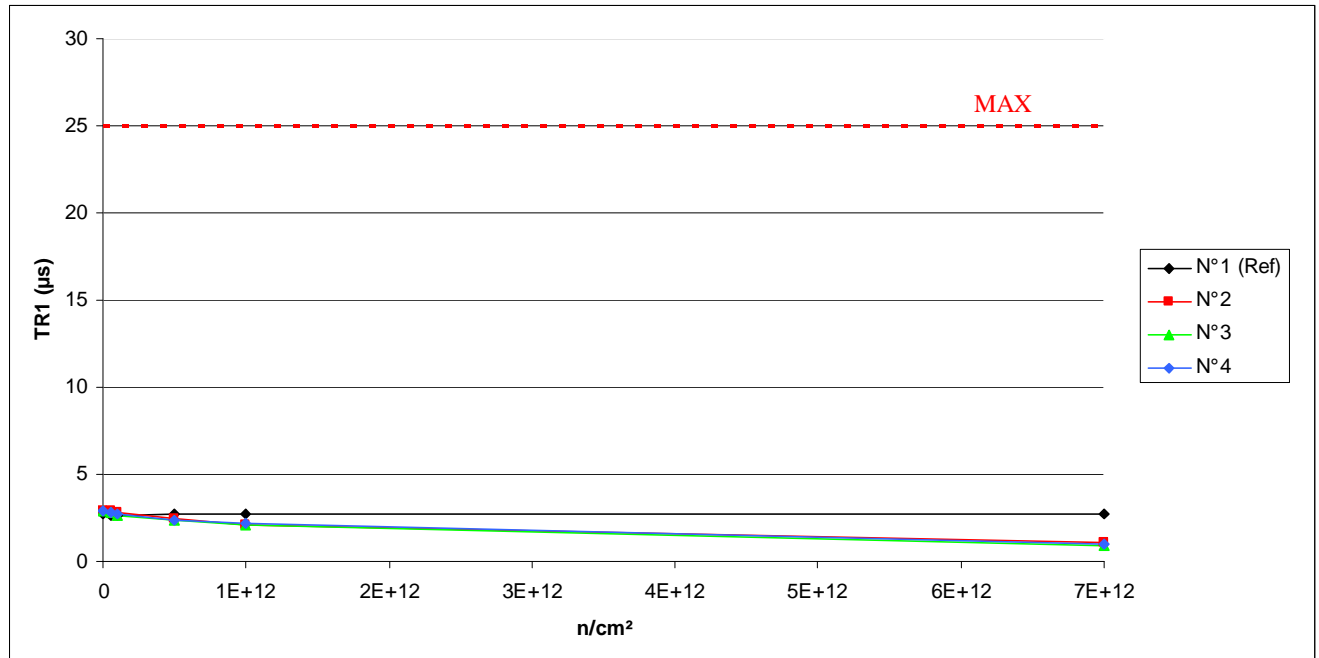

**TR1. (µs) Max = 25.0**

	0.n/cm²	5E10.n/cm²	1E11.n/cm²	5E11.n/cm²	1E12.n/cm²	7E12.n/cm²
N° 1 (Ref)	2.72	2.68	2.68	2.72	2.72	2.72
N° 2	2.92	2.92	2.80	2.48	2.12	1.12
N° 3	2.92	2.80	2.68	2.32	2.12	0.92
N° 4	2.92	2.80	2.76	2.40	2.16	0.96

**Delta [TR1]**

	0.n/cm²	5E10.n/cm²	1E11.n/cm²	5E11.n/cm²	1E12.n/cm²	7E12.n/cm²
N° 1 (Ref)	---	-4.000E-2	-4.000E-2	0.000E+0	0.000E+0	0.000E+0
N° 2	---	0.000E+0	-1.200E-1	-4.400E-1	-8.000E-1	-1.800E+0
N° 3	---	-1.200E-1	-2.400E-1	-6.000E-1	-8.000E-1	-2.000E+0
N° 4	---	-1.200E-1	-1.600E-1	-5.200E-1	-7.600E-1	-1.960E+0
Average	---	-8.000E-2	-1.733E-1	-5.200E-1	-7.867E-1	-1.920E+0
σ	---	6.928E-2	6.110E-2	8.000E-2	2.309E-2	1.058E-1
Average+3σ	---	1.278E-1	9.970E-3	-2.800E-1	-7.174E-1	-1.603E+0
Average-3σ	---	-2.878E-1	-3.566E-1	-7.600E-1	-8.559E-1	-2.237E+0

## 9. TF1

Ta=20°C; Vcc=10V; If=5mA; RL=100 Ohms; Ib=0

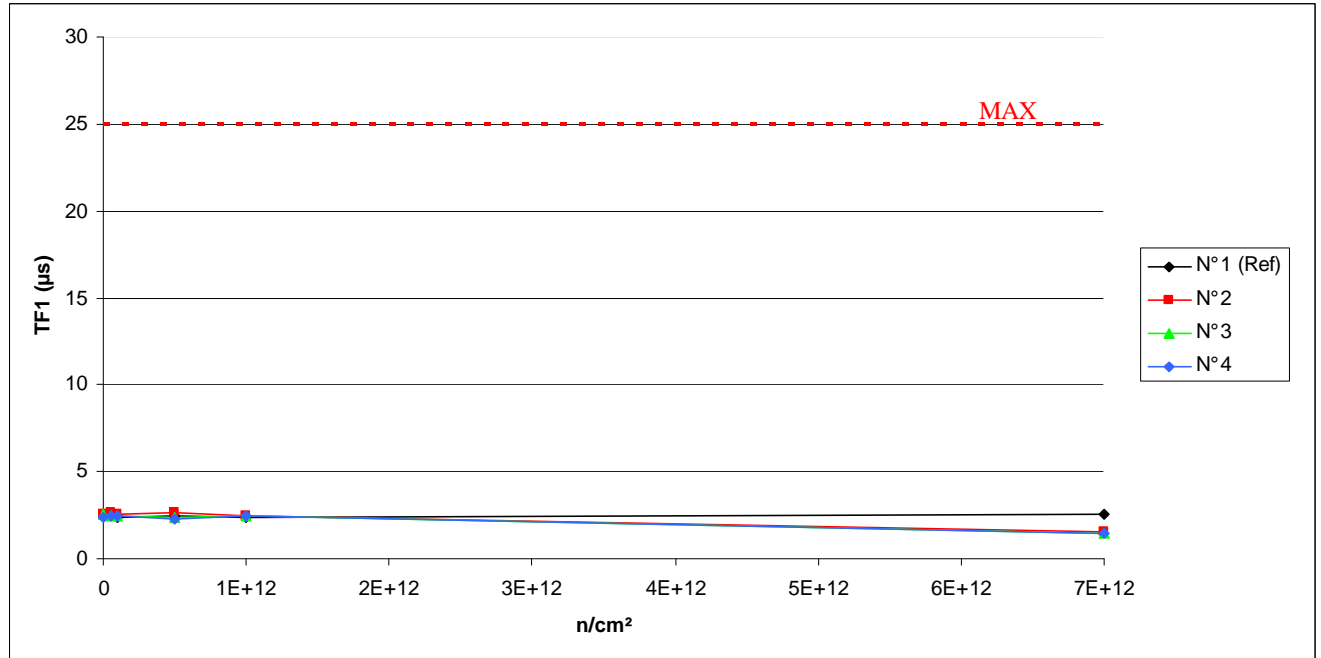

**TF1. (µs) Max = 25.0**

	0.n/cm²	5E10.n/cm²	1E11.n/cm²	5E11.n/cm²	1E12.n/cm²	7E12.n/cm²
N° 1 (Ref)	2.44	2.44	2.40	2.44	2.40	2.52
N° 2	2.56	2.60	2.56	2.60	2.44	1.56
N° 3	2.56	2.44	2.48	2.40	2.48	1.48
N° 4	2.40	2.44	2.44	2.32	2.44	1.44

**Delta [TF1]**

	0.n/cm²	5E10.n/cm²	1E11.n/cm²	5E11.n/cm²	1E12.n/cm²	7E12.n/cm²
N° 1 (Ref)	---	0.000E+0	-4.000E-2	0.000E+0	-4.000E-2	8.000E-2
N° 2	---	4.000E-2	0.000E+0	4.000E-2	-1.200E-1	-1.000E+0
N° 3	---	-1.200E-1	-8.000E-2	-1.600E-1	-8.000E-2	-1.080E+0
N° 4	---	4.000E-2	4.000E-2	-8.000E-2	4.000E-2	-9.600E-1
Average	---	-1.333E-2	-1.333E-2	-6.667E-2	-5.333E-2	-1.013E+0
σ	---	9.238E-2	6.110E-2	1.007E-1	8.327E-2	6.110E-2
Average+3σ	---	2.638E-1	1.700E-1	2.353E-1	1.965E-1	-8.300E-1
Average-3σ	---	-2.905E-1	-1.966E-1	-3.687E-1	-3.031E-1	-1.197E+0

## 10.TR2

Ta=20°C; Vcc=10V; If=5mA; RL=100 Ohms; Ie=0

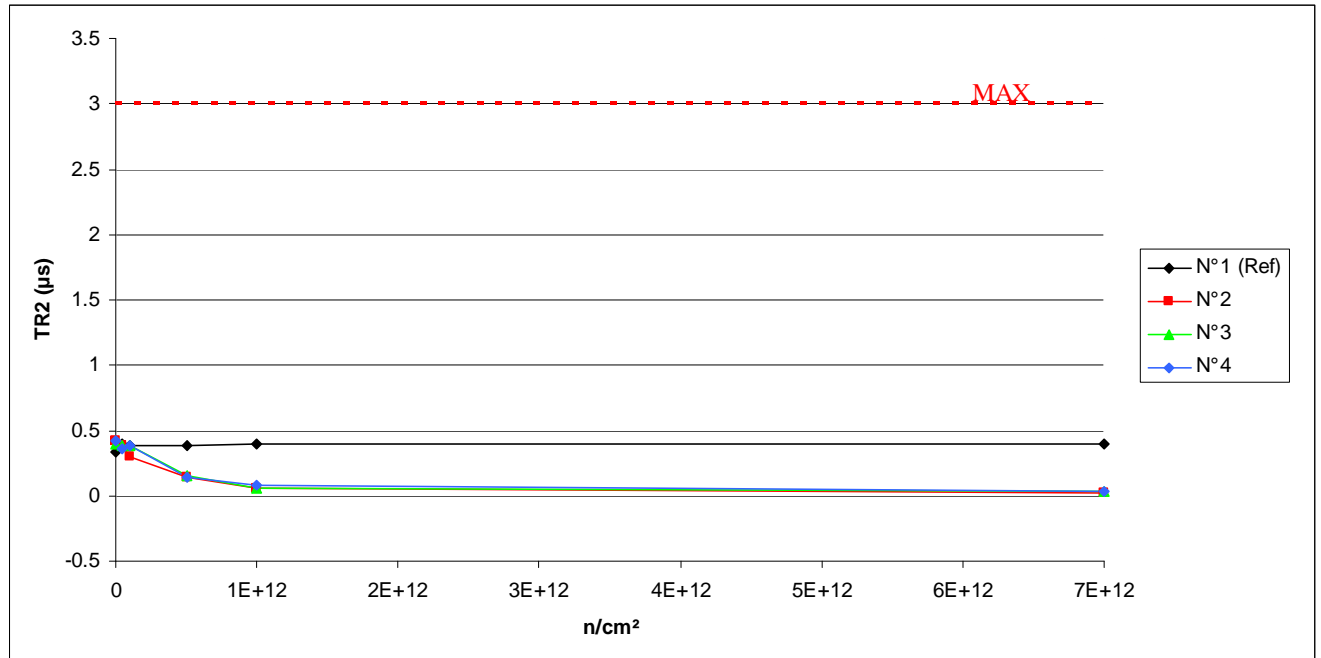

TR2. (µs)

Max = 3.0

	0.n/cm²	5E10.n/cm²	1E11.n/cm²	5E11.n/cm²	1E12.n/cm²	7E12.n/cm²
N° 1 (Ref)	0.34	0.40	0.38	0.38	0.40	0.40
N° 2	0.42	0.38	0.30	0.14	0.06	0.02
N° 3	0.40	0.38	0.38	0.16	0.06	0.03
N° 4	0.42	0.36	0.38	0.14	0.08	0.03

Delta [TR2]

	0.n/cm²	5E10.n/cm²	1E11.n/cm²	5E11.n/cm²	1E12.n/cm²	7E12.n/cm²
N° 1 (Ref)	---	6.000E-2	4.000E-2	4.000E-2	6.000E-2	6.000E-2
N° 2	---	-4.000E-2	-1.200E-1	-2.800E-1	-3.600E-1	-4.000E-1
N° 3	---	-2.000E-2	-2.000E-2	-2.400E-1	-3.400E-1	-3.740E-1
N° 4	---	-6.000E-2	-4.000E-2	-2.800E-1	-3.400E-1	-3.900E-1
Average	---	-4.000E-2	-6.000E-2	-2.667E-1	-3.467E-1	-3.880E-1
σ	---	2.000E-2	5.292E-2	2.309E-2	1.155E-2	1.311E-2
Average+3σ	---	2.000E-2	9.875E-2	-1.974E-1	-3.120E-1	-3.487E-1
Average-3σ	---	-1.000E-1	-2.187E-1	-3.359E-1	-3.813E-1	-4.273E-1

## 11.TF2

Ta=20°C; Vcc=10V; If=5mA; RL=100 Ohms; Ie=0

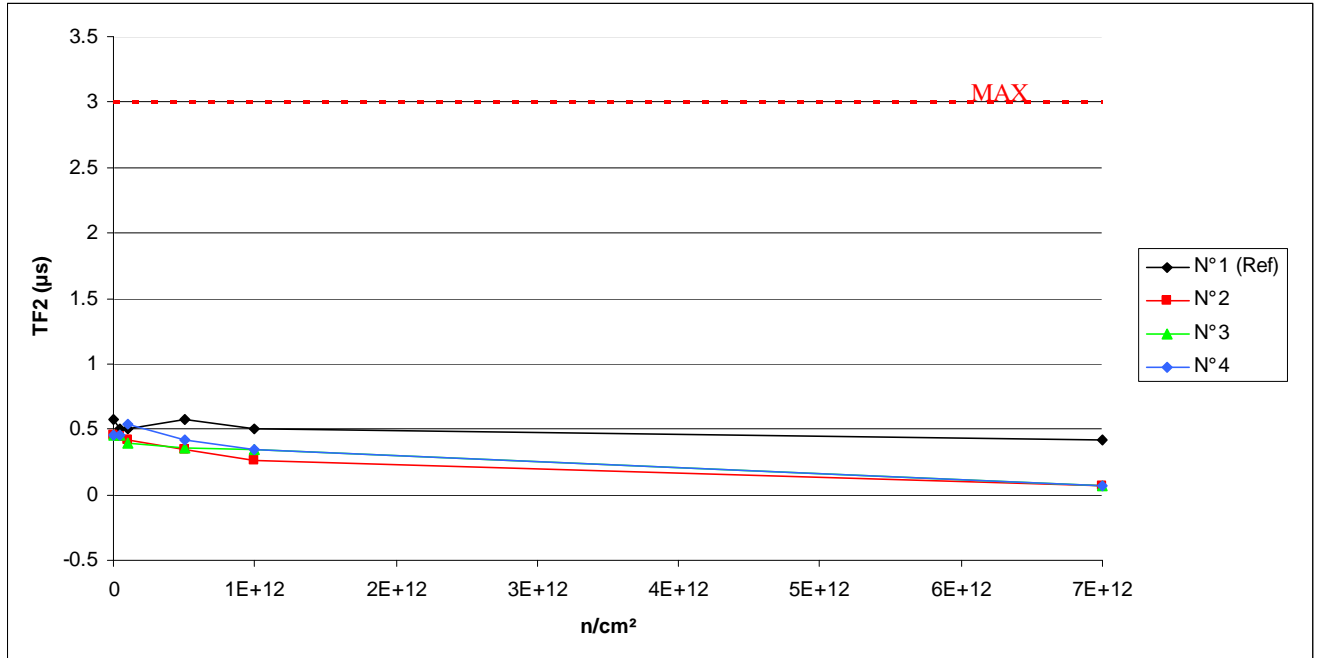

**TF2. (µs) Max = 3.0**

	0.n/cm²	5E10.n/cm²	1E11.n/cm²	5E11.n/cm²	1E12.n/cm²	7E12.n/cm²
N° 1 (Ref)	0.58	0.50	0.50	0.58	0.50	0.42
N° 2	0.46	0.44	0.42	0.34	0.26	0.07
N° 3	0.46	0.46	0.40	0.36	0.34	0.07
N° 4	0.46	0.46	0.54	0.42	0.34	0.07

**Delta [TF2]**

	0.n/cm²	5E10.n/cm²	1E11.n/cm²	5E11.n/cm²	1E12.n/cm²	7E12.n/cm²
N° 1 (Ref)	---	-8.000E-2	-8.000E-2	0.000E+0	-8.000E-2	-1.600E-1
N° 2	---	-2.000E-2	-4.000E-2	-1.200E-1	-2.000E-1	-3.920E-1
N° 3	---	0.000E+0	-6.000E-2	-1.000E-1	-1.200E-1	-3.920E-1
N° 4	---	0.000E+0	8.000E-2	-4.000E-2	-1.200E-1	-3.920E-1
Average	---	-6.667E-3	-6.667E-3	-8.667E-2	-1.467E-1	-3.920E-1
σ	---	1.155E-2	7.572E-2	4.163E-2	4.619E-2	6.799E-17
Average+3σ	---	2.797E-2	2.205E-1	3.823E-2	-8.103E-3	-3.920E-1
Average-3σ	---	-4.131E-2	-2.338E-1	-2.116E-1	-2.852E-1	-3.920E-1

## 12.CTR1

Ta=20°C; Vce=5V; If=1mA

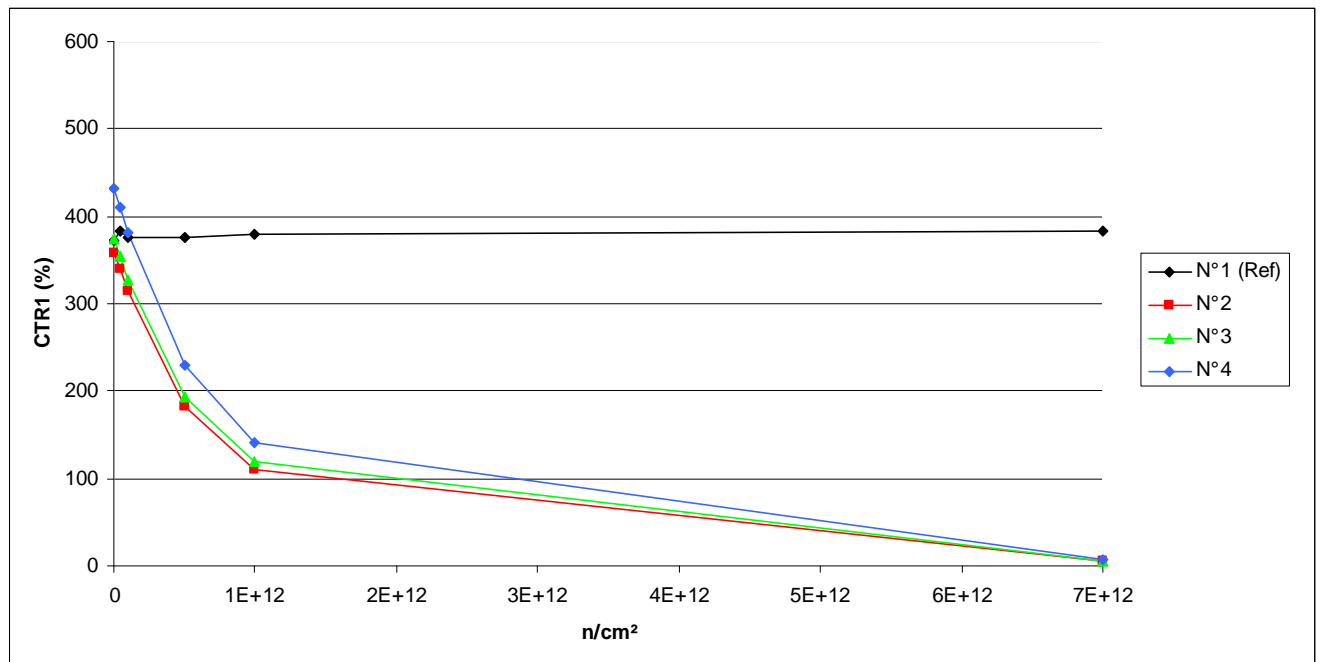

### CTR1. (%)

	0.n/cm²	5E10.n/cm²	1E11.n/cm²	5E11.n/cm²	1E12.n/cm²	7E12.n/cm²
N° 1 (Ref)	371.534	382.239	376.617	375.798	379.035	382.602
N° 2	357.614	340.510	313.892	182.830	110.045	5.783
N° 3	374.344	354.411	327.016	193.082	118.404	6.169
N° 4	431.922	410.599	380.850	229.314	140.822	7.245

### 1/Delta [CTR1]

	0.n/cm²	5E10.n/cm²	1E11.n/cm²	5E11.n/cm²	1E12.n/cm²	7E12.n/cm²
N° 1 (Ref)	---	-7.538E-5	-3.633E-5	-3.054E-5	-5.327E-5	-7.786E-5
N° 2	---	1.405E-4	3.895E-4	2.673E-3	6.291E-3	1.701E-1
N° 3	---	1.502E-4	3.866E-4	2.508E-3	5.774E-3	1.594E-1
N° 4	---	1.202E-4	3.105E-4	2.046E-3	4.786E-3	1.357E-1
Average	---	1.370E-4	3.622E-4	2.409E-3	5.617E-3	1.551E-1
σ	---	1.531E-5	4.481E-5	3.253E-4	7.647E-4	1.761E-2
Average+3σ	---	1.829E-4	4.966E-4	3.385E-3	7.911E-3	2.079E-1
Average-3σ	---	9.106E-5	2.278E-4	1.433E-3	3.323E-3	1.022E-1



### 13. CTR2

Ta=20°C; Vce=5V; If=2mA

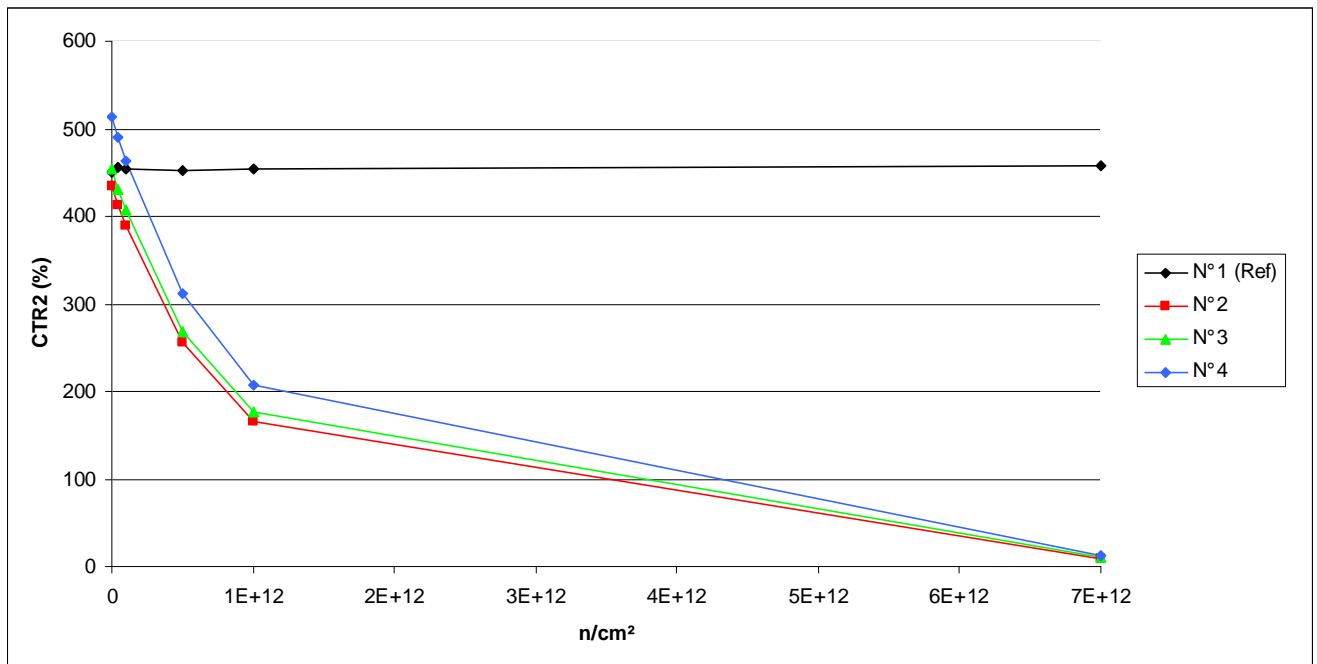

#### CTR2. (%)

	0.n/cm²	5E10.n/cm²	1E11.n/cm²	5E11.n/cm²	1E12.n/cm²	7E12.n/cm²
N° 1 (Ref)	450.703	455.805	453.257	452.210	454.860	456.872
N° 2	434.253	413.307	389.838	255.172	165.286	9.778
N° 3	453.809	431.028	406.961	268.475	177.410	10.492
N° 4	512.904	489.281	462.667	311.683	206.639	12.281

#### 1/Delta [CTR2]

	0.n/cm²	5E10.n/cm²	1E11.n/cm²	5E11.n/cm²	1E12.n/cm²	7E12.n/cm²
N° 1 (Ref)	---	-2.484E-5	-1.250E-5	-7.395E-6	-2.028E-5	-2.996E-5
N° 2	---	1.167E-4	2.624E-4	1.616E-3	3.747E-3	9.997E-2
N° 3	---	1.165E-4	2.537E-4	1.521E-3	3.433E-3	9.311E-2
N° 4	---	9.413E-5	2.117E-4	1.259E-3	2.890E-3	7.948E-2
Average	---	1.091E-4	2.426E-4	1.465E-3	3.357E-3	9.085E-2
σ	---	1.296E-5	2.709E-5	1.851E-4	4.339E-4	1.043E-2
Average+3σ	---	1.480E-4	3.239E-4	2.021E-3	4.658E-3	1.221E-1
Average-3σ	---	7.021E-5	1.613E-4	9.099E-4	2.055E-3	5.956E-2

## 14.CTR3

Ta=20°C; Vce=5V; If=10mA

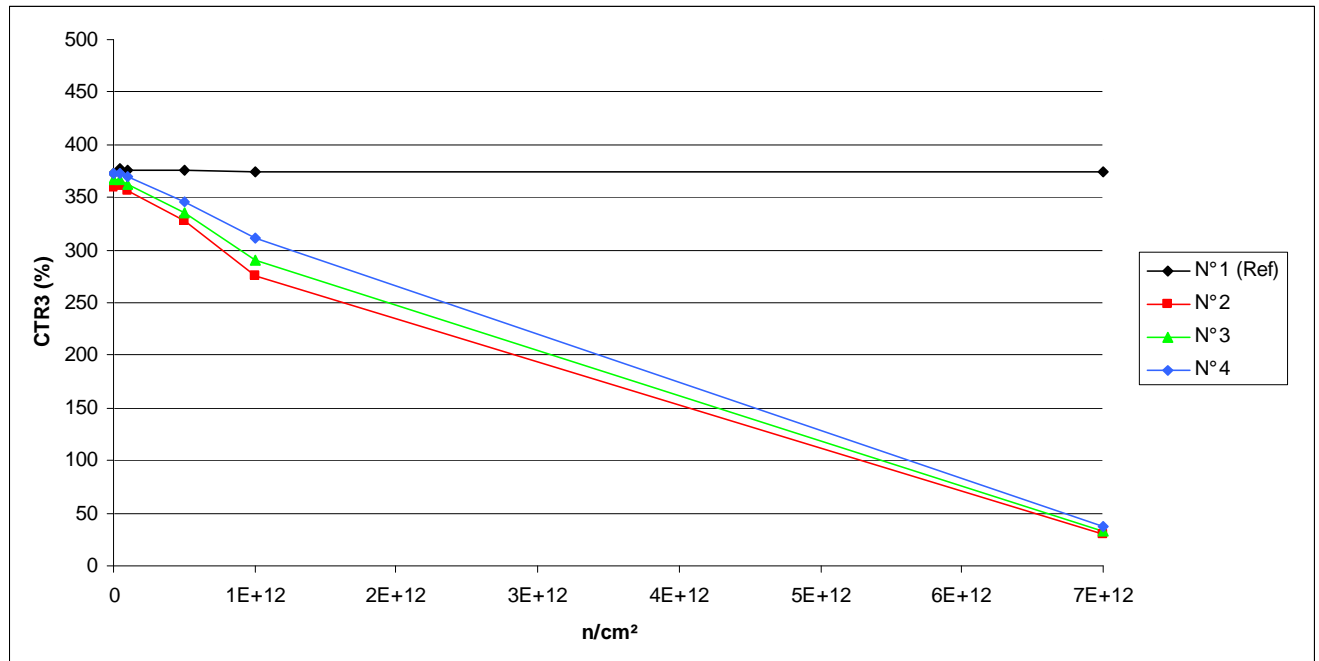

CTR3. (%)

	0.n/cm²	5E10.n/cm²	1E11.n/cm²	5E11.n/cm²	1E12.n/cm²	7E12.n/cm²
N° 1 (Ref)	373.235	376.658	375.282	376.339	374.908	373.665
N° 2	359.635	360.644	356.601	327.298	275.090	30.411
N° 3	367.035	366.565	362.517	335.256	289.759	32.972
N° 4	373.190	373.473	369.223	345.451	311.165	38.164

1/Delta [CTR3]

	0.n/cm²	5E10.n/cm²	1E11.n/cm²	5E11.n/cm²	1E12.n/cm²	7E12.n/cm²
N° 1 (Ref)	---	-2.435E-5	-1.462E-5	-2.210E-5	-1.196E-5	-3.087E-6
N° 2	---	-7.779E-6	2.366E-5	2.747E-4	8.546E-4	3.010E-2
N° 3	---	3.488E-6	3.395E-5	2.583E-4	7.266E-4	2.760E-2
N° 4	---	-2.033E-6	2.879E-5	2.152E-4	5.341E-4	2.352E-2
Average	---	-2.108E-6	2.880E-5	2.494E-4	7.051E-4	2.708E-2
σ	---	5.634E-6	5.143E-6	3.076E-5	1.613E-4	3.321E-3
Average+3σ	---	1.479E-5	4.423E-5	3.417E-4	1.189E-3	3.704E-2
Average-3σ	---	-1.901E-5	1.337E-5	1.571E-4	2.212E-4	1.711E-2

## 15.CTR4

Ta=20°C; Vce=5V; If=50mA

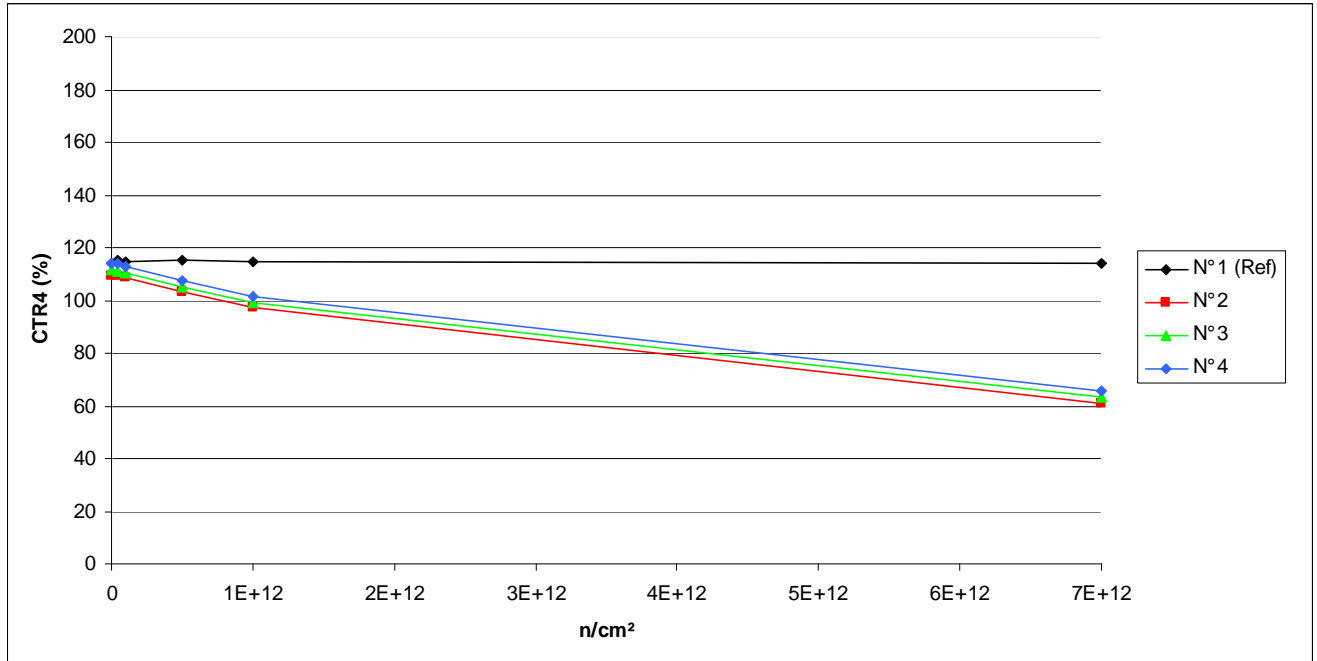

CTR4 . (%)

	0.n/cm²	5E10.n/cm²	1E11.n/cm²	5E11.n/cm²	1E12.n/cm²	7E12.n/cm²
N° 1 (Ref)	114.323	115.097	114.776	115.047	114.694	114.325
N° 2	109.275	109.513	108.583	103.089	97.495	60.662
N° 3	111.454	111.293	110.336	104.844	99.342	63.329
N° 4	114.093	114.018	112.931	107.255	101.266	65.834

1/Delta [CTR4]

	0.n/cm²	5E10.n/cm²	1E11.n/cm²	5E11.n/cm²	1E12.n/cm²	7E12.n/cm²
N° 1 (Ref)	---	-5.882E-5	-3.452E-5	-5.506E-5	-2.833E-5	-1.377E-7
N° 2	---	-1.992E-5	5.829E-5	5.491E-4	1.106E-3	7.334E-3
N° 3	---	1.303E-5	9.091E-5	5.657E-4	1.094E-3	6.818E-3
N° 4	---	5.781E-6	9.018E-5	5.588E-4	1.110E-3	6.425E-3
Average	---	-3.709E-7	7.979E-5	5.579E-4	1.103E-3	6.859E-3
σ	---	1.731E-5	1.863E-5	8.344E-6	8.395E-6	4.557E-4
Average+3σ	---	5.157E-5	1.357E-4	5.829E-4	1.129E-3	8.226E-3
Average-3σ	---	-5.231E-5	2.390E-5	5.328E-4	1.078E-3	5.492E-3

## 16.CTR5

Ta=20°C; Vce=30V; If=10mA

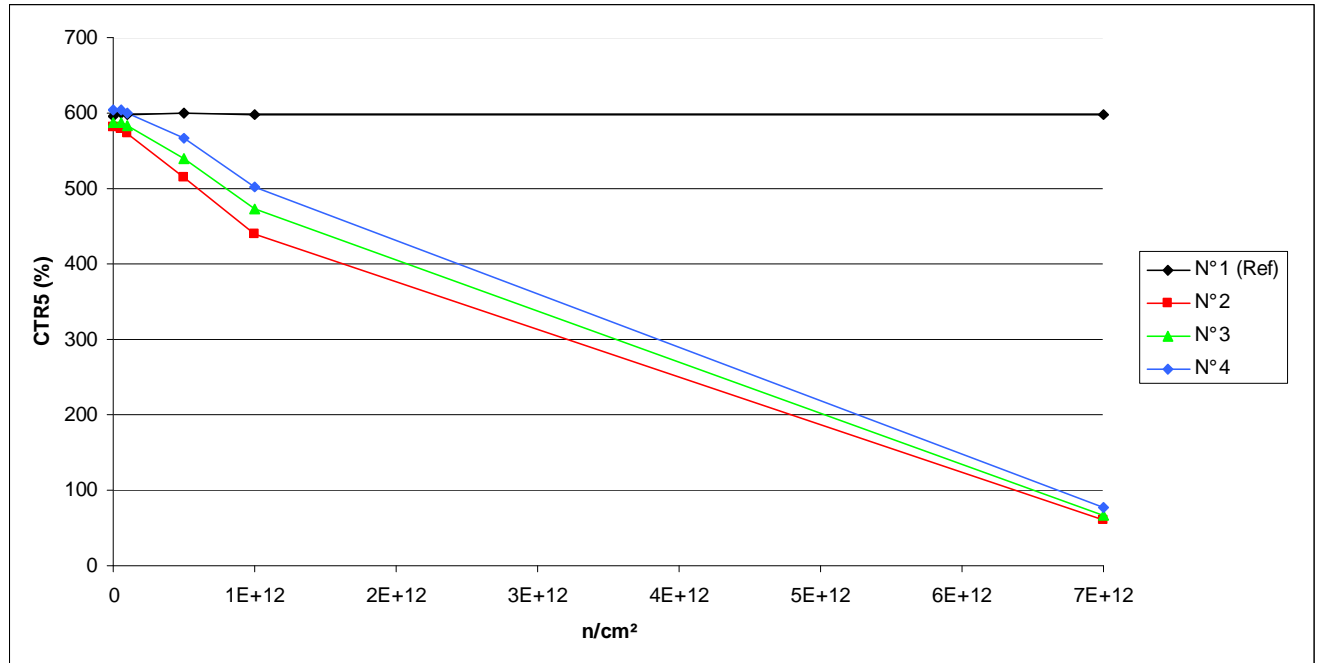

### CTR5 . (%)

	0.n/cm²	5E10.n/cm²	1E11.n/cm²	5E11.n/cm²	1E12.n/cm²	7E12.n/cm²
N° 1 (Ref)	595.630	599.991	598.638	599.332	597.800	597.319
N° 2	580.553	580.005	573.000	515.501	439.131	60.934
N° 3	588.372	588.073	583.013	539.324	472.335	66.871
N° 4	603.470	604.373	600.109	565.920	502.055	76.186

### 1/Delta [CTR5]

	0.n/cm²	5E10.n/cm²	1E11.n/cm²	5E11.n/cm²	1E12.n/cm²	7E12.n/cm²
N° 1 (Ref)	---	-1.220E-5	-8.435E-6	-1.037E-5	-6.094E-6	-4.748E-6
N° 2	---	1.627E-6	2.271E-5	2.174E-4	5.547E-4	1.469E-2
N° 3	---	8.644E-7	1.562E-5	1.546E-4	4.175E-4	1.325E-2
N° 4	---	-2.475E-6	9.283E-6	1.100E-4	3.347E-4	1.147E-2
Average	---	5.225E-9	1.587E-5	1.606E-4	4.357E-4	1.314E-2
σ	---	2.182E-6	6.715E-6	5.396E-5	1.111E-4	1.613E-3
Average+3σ	---	6.550E-6	3.601E-5	3.225E-4	7.690E-4	1.798E-2
Average-3σ	---	-6.540E-6	-4.273E-6	-1.261E-6	1.023E-4	8.298E-3

## 17.TRR

Ta=20°C; If = 5mA; RL = 100 Ohms; Irec = 10% Irm

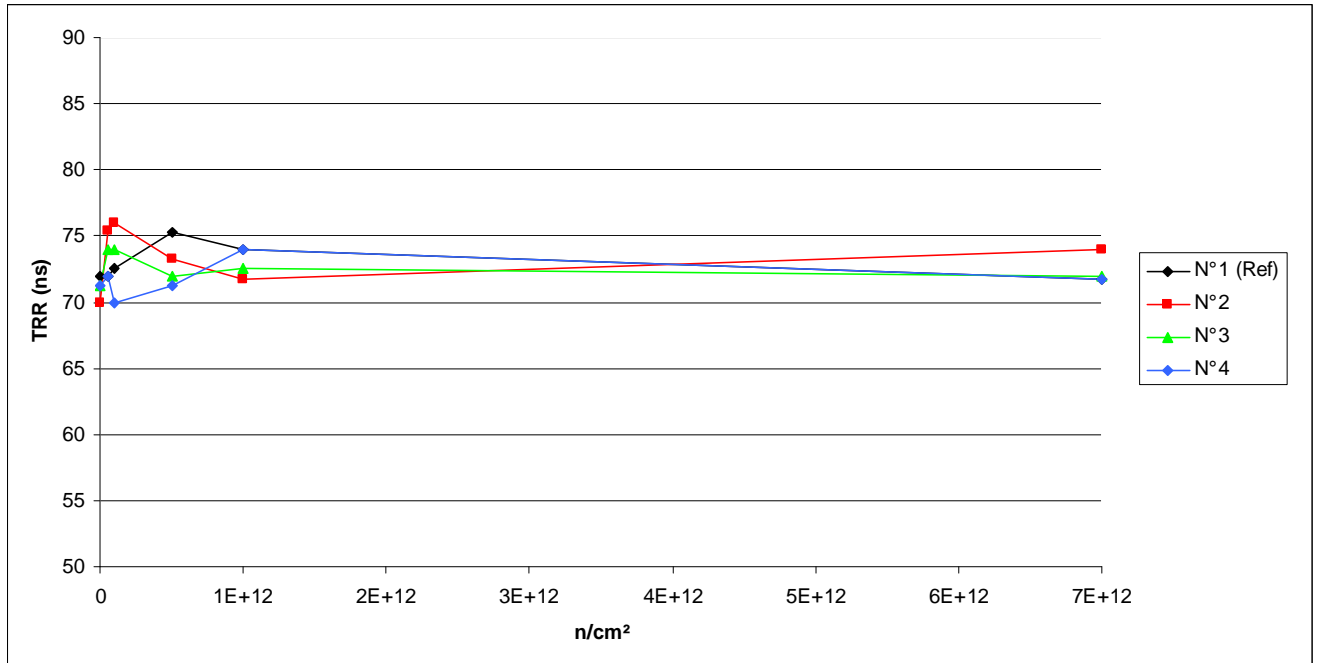

### TRR. (ns)

	0.n/cm²	5E10.n/cm²	1E11.n/cm²	5E11.n/cm²	1E12.n/cm²	7E12.n/cm²
N° 1 (Ref)	72.000	72.000	72.549	75.248	74.000	71.667
N° 2	70.000	75.410	76.033	73.267	71.667	74.000
N° 3	71.287	74.000	74.000	72.000	72.549	72.000
N° 4	71.287	72.000	69.903	71.287	74.000	71.667

### Delta [TRR]

	0.n/cm²	5E10.n/cm²	1E11.n/cm²	5E11.n/cm²	1E12.n/cm²	7E12.n/cm²
N° 1 (Ref)	---	0.000E+0	5.490E-1	3.248E+0	2.000E+0	-3.333E-1
N° 2	---	5.410E+0	6.033E+0	3.267E+0	1.667E+0	4.000E+0
N° 3	---	2.713E+0	2.713E+0	7.129E-1	1.262E+0	7.129E-1
N° 4	---	7.129E-1	-1.384E+0	0.000E+0	2.713E+0	3.795E-1
Average	---	2.945E+0	2.454E+0	1.327E+0	1.880E+0	1.697E+0
σ	---	2.357E+0	3.715E+0	1.718E+0	7.487E-1	2.001E+0
Average+3σ	---	1.002E+1	1.360E+1	6.481E+0	4.127E+0	7.700E+0
Average-3σ	---	-4.126E+0	-8.692E+0	-3.827E+0	-3.658E-1	-4.306E+0