

TOTAL IONIZING DOSE TEST REPORT

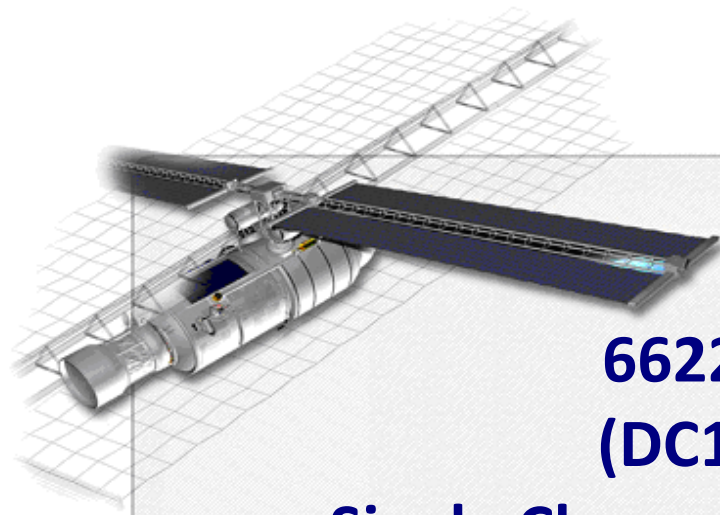

66221-103 (DC1122) Single Channel Optocoupler From MICROPAC



TRAD/TE/66221/XXX1/ESA/YP/1104		Labège, April 19th, 2012
 		TRAD, Bât Gallium 907, Voie l'Occitane - 31670 LABEGE France ☎ : 05 61 00 95 60 Fax : 05 61 00 95 61 Email : trad@trad.fr Web Site: www.trad.fr SIRET 397 862 038 00056 - TVA FR59397862038
Written by	Verified by / Quality control	Approved by
A. SAMARAS 19/04/2012	M.SAUVAGNAC/Y.PADIE 11/05/2012	C.CHATRY 11/05/2012
Issue : 0		
To: Marc POIZAT	Project/Program :	ESA Contract N°4000102571/10/NL/AF-Radiation Characterization of Laplace RH optocouplers, sensors and detectors

TABLE OF CONTENT

1	INTRODUCTION	3
2	DOCUMENTS	3
2.1	Applicable Documents	3
2.2	Reference Documents.....	3
3	DEVICE INFORMATION	3
3.1	Device description.....	3
3.2	Procurement information	4
3.3	External view.....	4
3.4	Internal view	4
3.5	Serialization.....	5
4	IRRADIATION MEANS AND CONDITIONS	6
4.1	UCL irradiation facility (Belgium)	6
4.2	Dose measurement.....	6
4.3	Experimental conditions	6
5	ELECTRICAL TESTS	6
5.1	Test set-up	7
5.2	Test configuration.....	7
5.3	Electrical parameters	8
6	TEST HISTORY	8
7	SUMMARY RESULTS.....	9
8	CONCLUSION	10
9	DETAILED TESTS RESULTS.....	11

LIST OF FIGURES

Figure 1: package marking.....	4
Figure 2: package back.....	4
Figure 3: Internal general view	4
Figure 4: transistor die view.....	4
Figure 5: photodetector and LED view	5
Figure 6: test principle	7
Figure 7: ON bias1	7
Figure 8: ON bias2.....	7
Figure 9: ON Bias 1	9
Figure 10: ON Bias 2	9
Figure 11: OFF.....	9
Figure 12 : Ic(on) parameter function Total Ionizing Dose.....	10
Figure 13: Average drift current transfer ratio function of the Bias condition and CTR configuration.....	10

1 INTRODUCTION

This report includes the test results of 66221-103, a Single Channel Optocoupler from MICROPAC to evaluate Total Ionizing Dose (TID) effects under Co60 irradiation. Between November 2011 and February 2012, TRAD characterized this device for TID sensitivity at the UCL Facility, Belgium using their Gamma irradiation Facility.

The objectives of the test are:

- to detect and measure the degradation of device parameters as a function of TID,
- to determine if device parameters are within specified limits after exposure to final TID level.

2 DOCUMENTS

2.1 Applicable Documents

AD	1.	ESA contract	N°4000102571/10/NL/AF-Radiation Characterization of Laplace RH optocouplers, sensors and detectors
AD	2.	Irradiation Test Plan	ITP-TE-66221-MIC-ESA-1115, Iss.2, 16/06/11

2.2 Reference Documents

RD	1.	Datasheet 66221 by MICROPAC	PROTON RADIATION TOLERANT OPTOCOUPLER dated 31/03/2011
RD	2.	MICROPAC certificate of traceability and conformance dated 25/07/2011	

3 DEVICE INFORMATION

3.1 Device description

The 66221-103 is a single channel device electrically similar to the 4N49. It contains an 850nm LED optically coupled to a silicon planar phototransistor. This product has been designed to be more tolerant to proton radiation. The 66221 optocoupler is packaged in a hermetically sealed 6 pin leadless chip carrier (LCC).

Type	66221-103
Manufacturer	MICROPAC
Function	Optocoupler
Package	LCC6
Date Code	1122
Sample size	16 parts (15 + 1 control sample)

3.2 Procurement information

75 parts reference 66221-103 were delivered by MICROPAC through the French distributor ISOTOPE ELECTRONICS.

Their quality level defined by the 103 extension number corresponds to a commercial standard operating in the temperature range of -55° to +125°C and screened to TX level by the manufacturer prior delivery. One single lot of 75 parts, date-code 1122, was delivered together with a Certificate of Conformance [RD2].

3.3 External view



Figure 1: package marking

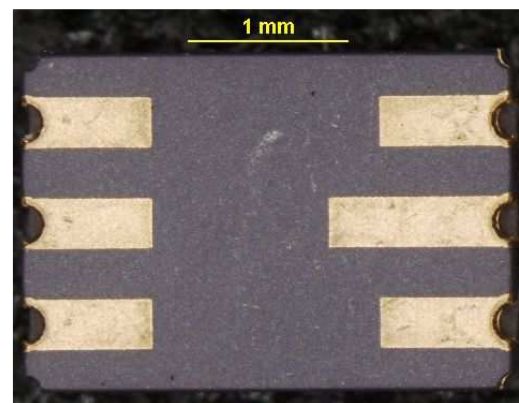

Figure 2: package back

3.4 Internal view

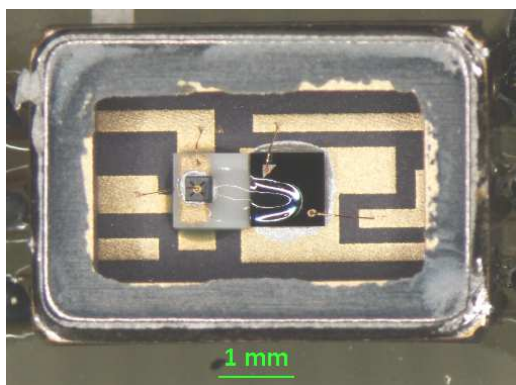

Figure 3: Internal general view

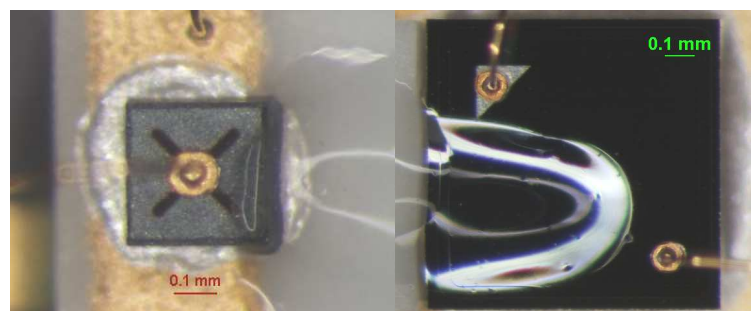

Figure 4: transistor die view

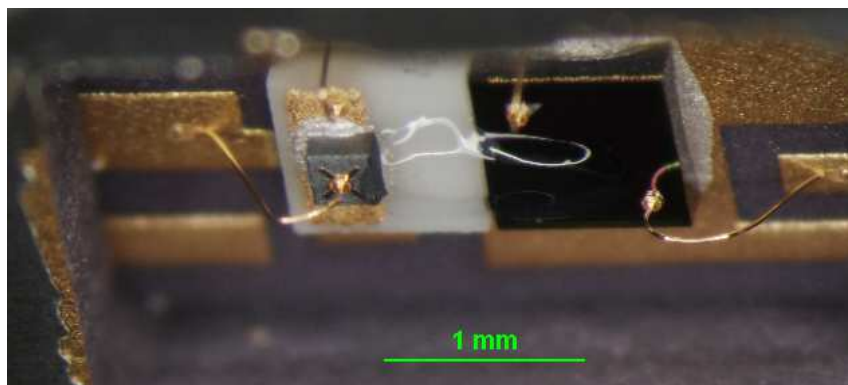

Figure 5: photodetector and LED view

3.5 Serialization

Each part is serialized to enable pre and post test identification and comparison.

Serial Number	Control sample	Test samples														
Serialization	1	2	3	4	5	6	7	8	9	10	11	12	13	14	15	16
	Ref	Bias1	Bias1	Bias1	Bias1	Bias1	Bias2	Bias2	Bias2	Bias2	Bias2	OFF	OFF	OFF	OFF	OFF

4 IRRADIATION MEANS AND CONDITIONS

4.1 UCL irradiation facility (Belgium)

Gamma irradiations are performed with Cobalt 60 source.
Gamma emitted radiation energies are 1.17 and 1.33 MeV.
Dose rates is equal 15 kRad(Si) / h at the source centre .
Moreover the irradiation chamber is a cylindrical room with a radius of 2m.
Then dose rate usable vary from 1.8 kRad(Si) / h to 80 Rad(Si) / h for normal irradiation positions and direct field.



4.2 Dose measurement

Alanine dosimeters are used for each test set up to control Total Ionizing Dose.

4.3 Experimental conditions

An accumulated dose of 200 krad(Si) of Co60 is required [AD2] for this TID (Total Ionizing Dose) evaluation test.

Seven steps are defined to determine the component degradation under Co60 irradiation.

The test devices have been exposed to ⁶⁰Co irradiation according to the following steps and respective dose rates:

	Step1	Step2	Step3	Step4	Step5	Step6	Step7	Step8
Accumulated dose krad(Si)	10	19	49	65	101	130	152	203
Dose rate (Si)/h	36	36	36	36	310	310	310	310

Two annealing steps are performed after Co60 irradiation:

Duration (h)	24	168
Temperature (°C)	25	100

5 ELECTRICAL TESTS

Electrical parameters to be measured in pre and post exposure tests are described in the following table. Electrical tests are performed on each part using the test set-up hereunder. All required data are recorded for each device. Test conditions and limits are given in the applicable irradiation test plan [AD2] and shown hereafter.

5.1 Test set-up

TEST BOARD	TRAD/CT1/E/OPTO/ZIP14/BR/1108
TEST PROGRAM	66221_TE_XXX1_B1_V10.Ilb 66221_TE_XXX1_B1_V20.Ilb

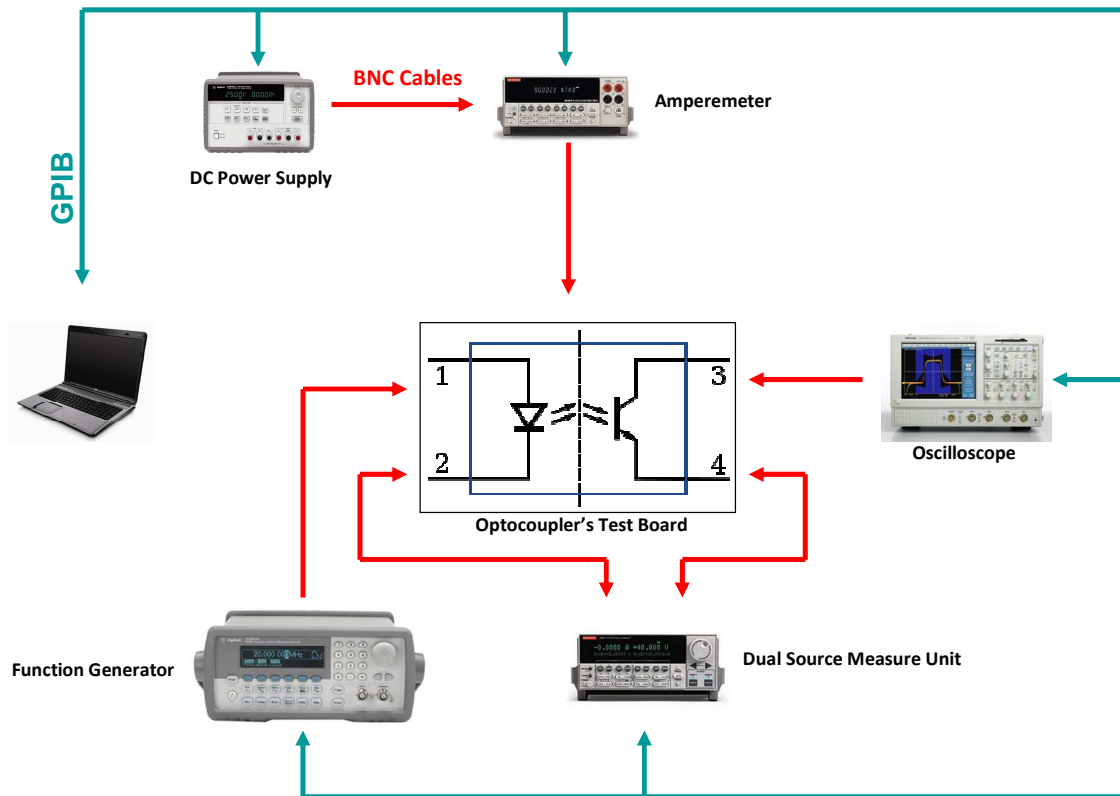

Figure 6: test principle

5.2 Test configuration

Samples were exposed to irradiation in three different modes - two ON modes (Figure 7 and Figure 8) and one in OFF mode (all terminal leads short-circuited) –

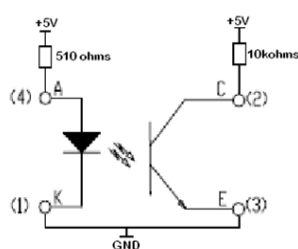

Figure 7: ON bias1

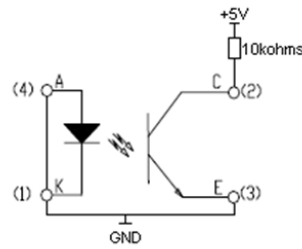

Figure 8: ON bias2

5.3 Electrical parameters

PARAMETER	SYMBOL	TEST CONDITION	MIN	MAX	UNIT
Input Diode Static Reverse Current	I_R	$V_R = 6 \text{ V}$		8	μA
Input Diode Static Forward Voltage	V_F	$I_F = 10 \text{ mA}$		1,6	V
Collector-Base Breakdown Voltage	$V_{(BR)CBO}$	$I_C = 100 \mu\text{A}, I_B = 0, I_F = 0$	60		V
Collector-Emitter Breakdown Voltage	$V_{(BR)CEO}$	$I_C = 1 \text{ mA}, I_B = 0, I_F = 0$	60		V
Emitter-Collector Breakdown Voltage	$V_{(BR)ECO}$	$I_C = 0 \text{ mA}, I_E = 100 \mu\text{A}, I_F = 0$	7		V
Off-State Collector Current	I_{CEO}	$V_{CE} = 20 \text{ V}, I_F = 0 \text{ mA}, I_B = 0$		100	nA
On State Collector Current	$I_{C(ON)}$	$V_{CE} = 5 \text{ V}, I_F = 1 \text{ mA}, I_B = 0^*$	2	10	mA
Rise Time- Phototransistor Operation	tr1	$V_{CC} = 10\text{V}, I_F = 5\text{mA}, R_L = 100\Omega, I_B = 0$		25	μs
Fall Time-Phototransistor Operation	tf1	$V_{CC} = 10\text{V}, I_F = 5\text{mA}, R_L = 100\Omega, I_B = 0$		25	μs
Rise Time-Photodiode Operation	tr2	$V_{CC} = 10\text{V}, I_F = 5\text{mA}, R_L = 100\Omega, I_E = 0$		3	μs
Fall Time-Photodiode Operation	tf2	$V_{CC} = 10\text{V}, I_F = 5\text{mA}, R_L = 100\Omega, I_E = 0$		3	μs
Current Transfer Ratio	CTR1	$V_{CE} = 5\text{V}, I_F = 1\text{mA}$			%
	CTR2	$V_{CE} = 5\text{V}, I_F = 2\text{mA}$			%
	CTR3	$V_{CE} = 5\text{V}, I_F = 10\text{mA}$			%
	CTR4	$V_{CE} = 5\text{V}, I_F = 50\text{mA}$			%
	CTR5	$V_{CE} = 30\text{V}, I_F = 10\text{mA}$			%
Input Diode Reverse Recovery Time	Trr	$I_F = 5\text{mA}, R_L = 100 \text{ Ohms}, I_{rec} = 10\% I_{rm}$			

(*)This parameter must be measured using pulse techniques ($t_W = 100 \mu\text{s}$ duty cycle $< 1\%$).

Min/ Max values are those specified in the reference data-sheet [RD1].

Test measurements are performed at $25^\circ\text{C} \pm 10^\circ\text{C}$.

6 TEST HISTORY

Initially, 7 steps were planned for this test sequence, as described hereunder.

	Step1	Step2	Step3	Step4	Step5	Step6	Step7
Accumulated dose krad(Si)	10	20	50	100	120	150	200
Dose rate (Si)/h	36	36	36	36	310	310	310

Due to irradiation facility maintenance, between Step 3 and Step 4 (50 krad(Si) and 100 krad(Si)), tests were stopped for 48 hours. Total Ionizing Dose was estimated at 65 krad(Si). After electrical measurement, parts were kept in a -30°C cold chamber.

7 SUMMARY RESULTS

Only parameters with applicable test limits are shown hereunder.

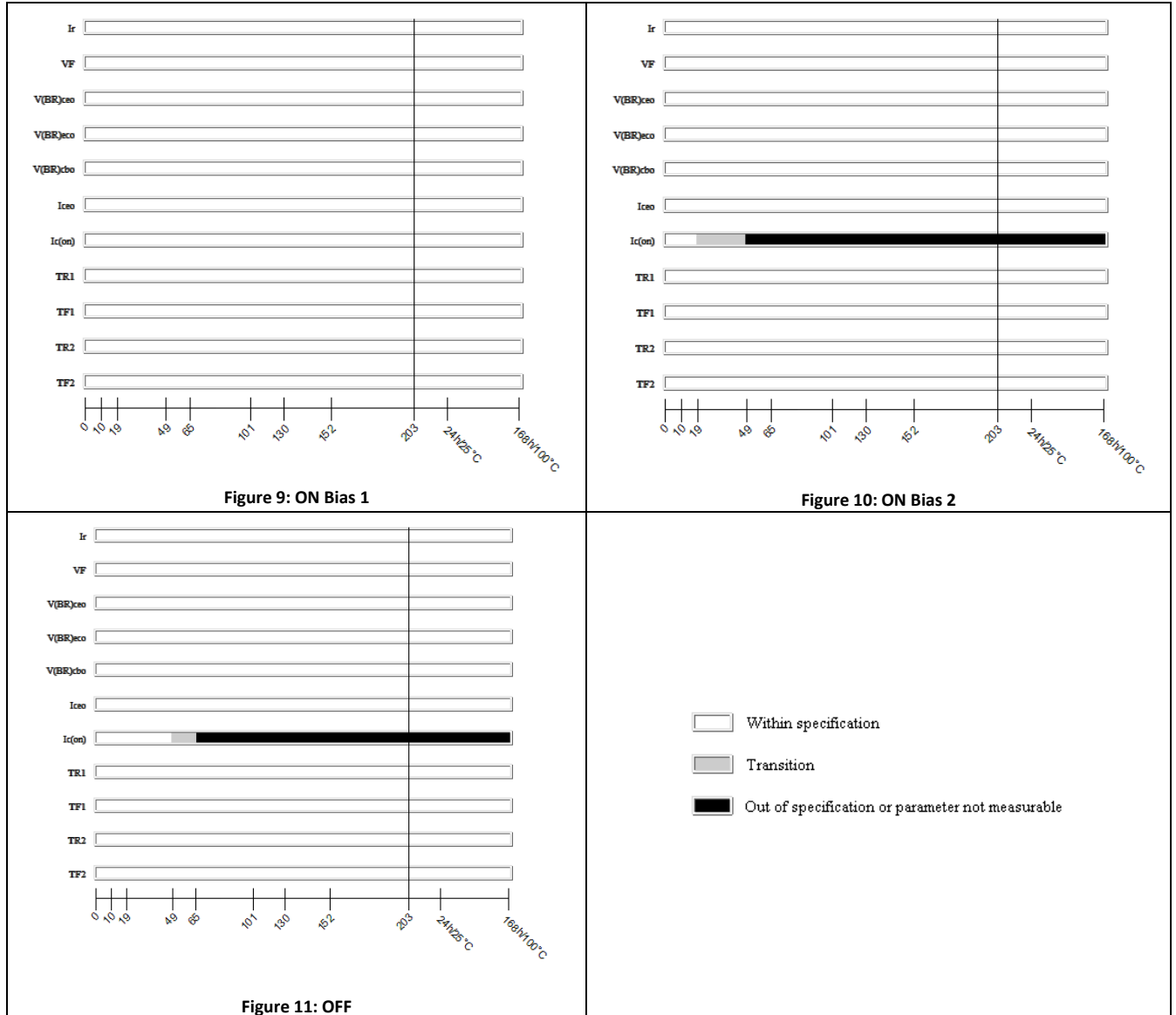

Ic(on) is out of specification

- at 24.2 krad(Si) by interpolation with the ON Bias 2 condition,
- at 52.6 krad(Si) by interpolation with unbiased parts.

8 CONCLUSION

Total Ionizing Dose steady-state irradiation test using Gamma ray has been applied on three bias condition on 66221-103, a Single Channel Optocoupler from MICROPAC up to 200krad(Si).

The results show that:

- For five devices tested, $I_c(on)$ is out of specification:
 - At step 49 krad(Si) with the ON Bias 2 condition
 - At step 65 krad(Si) with unbiased parts

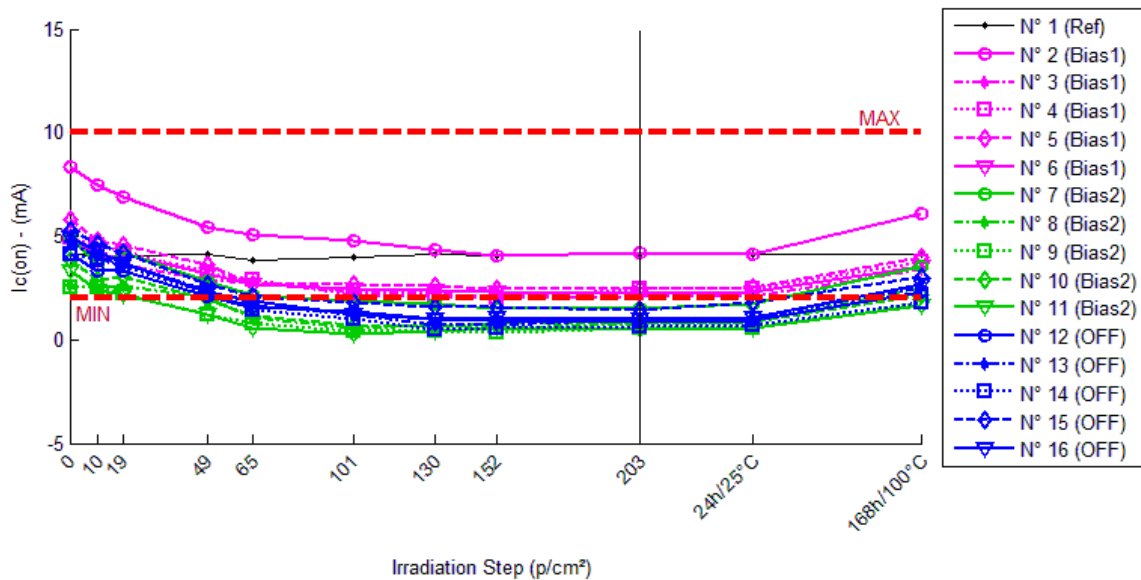

Figure 12 : $I_c(on)$ parameter function Total Ionizing Dose

- Average drift current transfer ratio are described in the next Figure for each bias condition and CTR configuration.

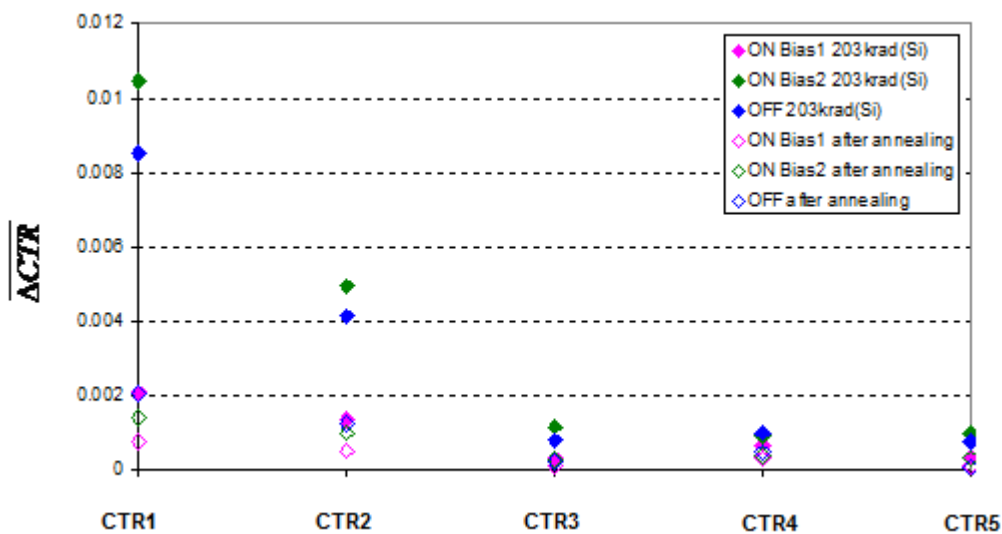

Figure 13: Average drift current transfer ratio function of the Bias condition and CTR configuration

- The CTR4 configuration (VCE = 30V, IF = 10mA) exhibits the smallest average parameter drift at the final accumulated dose (203krad(Si)).
- Conversely, the CRT1 configuration (VCE = 5V, IF = 1mA) exhibits the greatest parameter degradation at the final accumulated dose (203krad(Si)).
- ON Bias2 is the most sensitive configuration instead of ON Bias 1 which is the less sensitive.

As shown in previous figure, after annealing, average drift CTR decrease.

9 DETAILED TESTS RESULTS

The pre and post radiation test results are shown graphically in the following pages (9-2 to 9-52). The data is displayed in the following tables and graphs.

These graphs show parameter's shifts observed during the total ionizing dose sequence. The Control sample results are shown on each graph (black curve).

When available in the device data-sheet/specification, the maximum/minimum/typical values are also shown (red dotted line).

The tables include drift calculation between each measurement step and the "0" kRad(Si) step.

For CTR values, the formula used is:

$$\text{Drift} = \frac{1}{\text{measurement (X kRad(Si))}} - \frac{1}{\text{measurement (0 kRad(Si))}}$$

For other parameters, the formula used is:

$$\text{Drift value} = \text{measurement (X kRad(Si))} - \text{measurement (0 kRad(Si))}$$

CONTENTS

1. Ir.....	2
2. VF.....	5
3. V(BR)cbo.....	8
4. V(BR)ceo.....	11
5. V(BR)eco.....	14
6. lceo.....	17
7. lc(on).....	20
8. TR1.....	23
9. TF1.....	26
10. TR2.....	29
11. TF2.....	32
12. CTR1.....	35
13. CTR2.....	38
14. CTR3.....	41
15. CTR4.....	44
16. CTR5.....	47
17. TRR.....	50

1. I_r

T_a=25°C; V_R = 6V

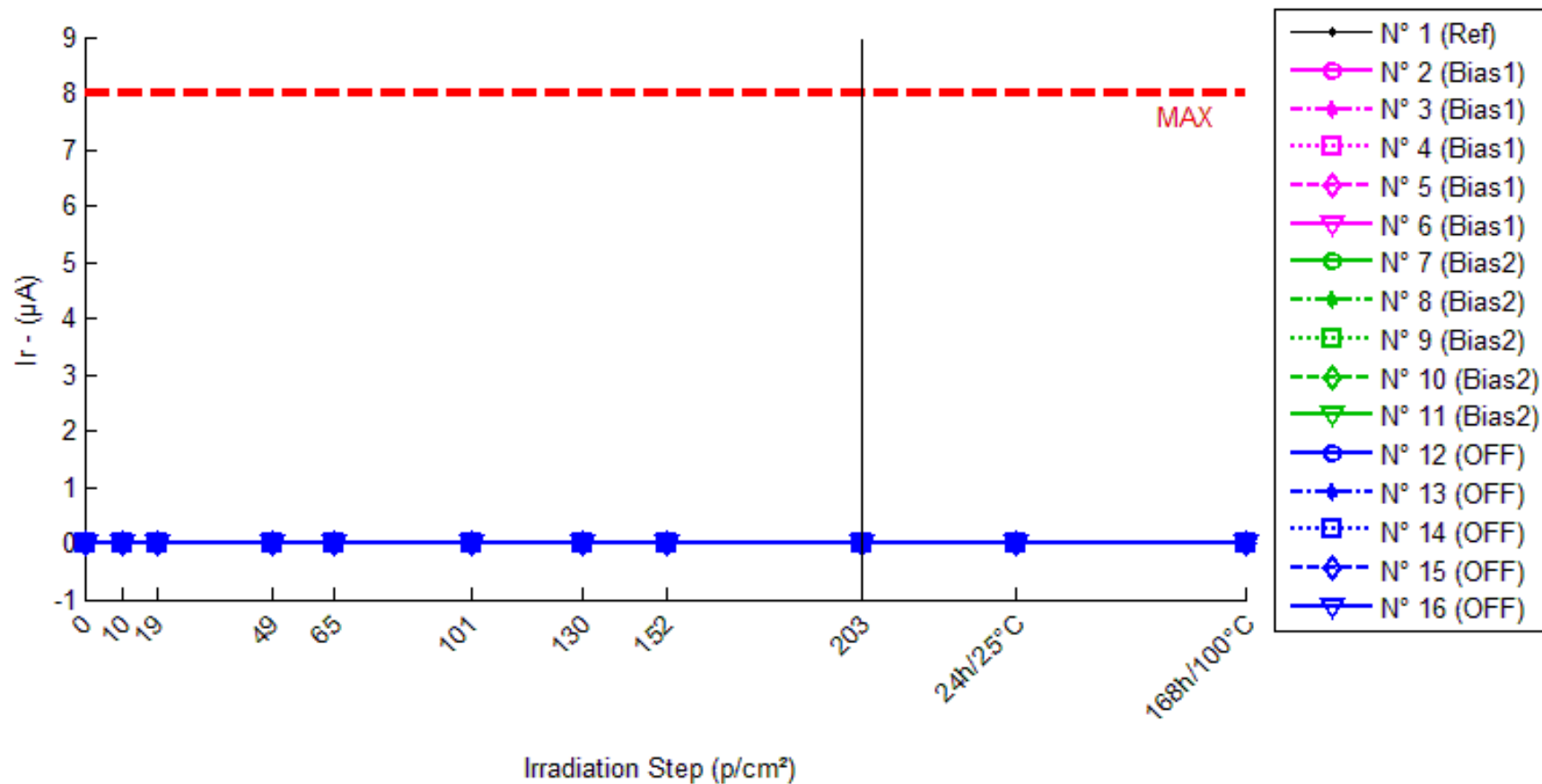

Ir. (µA)

Max = 8.0

	0krad(Si)	10krad(Si)	19krad(Si)	49krad(Si)	65krad(Si)	101krad(Si)	130krad(Si)	152krad(Si)	203krad(Si)	24h/25°C	168h/100°C
N° 1 (Ref)	2.504E-4	1.769E-4	1.240E-4	1.296E-4	1.143E-4	1.324E-4	2.177E-4	1.244E-4	1.246E-4	1.291E-4	4.022E-4
N° 2 (Bias1)	2.399E-4	1.845E-4	1.387E-4	1.535E-4	5.535E-3	4.078E-4	7.938E-4	1.448E-4	1.283E-4	1.609E-4	3.280E-4
N° 3 (Bias1)	2.254E-4	1.863E-4	1.368E-4	1.505E-4	2.134E-3	1.603E-4	2.294E-4	1.372E-4	1.395E-4	1.610E-4	3.431E-4
N° 4 (Bias1)	2.216E-4	1.814E-4	1.356E-4	1.433E-4	5.648E-3	4.657E-4	2.607E-4	1.316E-4	1.308E-4	1.338E-4	4.001E-4
N° 5 (Bias1)	2.321E-4	1.844E-4	1.325E-4	1.456E-4	1.415E-3	4.858E-4	2.732E-4	1.402E-4	1.357E-4	1.504E-4	2.715E-4
N° 6 (Bias1)	2.325E-4	1.813E-4	1.353E-4	1.409E-4	1.420E-4	1.419E-4	1.881E-4	1.319E-4	1.347E-4	1.456E-4	2.003E-4
N° 7 (Bias2)	2.400E-4	1.682E-4	1.250E-4	1.354E-4	1.343E-4	1.384E-4	2.089E-4	1.364E-4	1.455E-4	1.465E-4	2.909E-4
N° 8 (Bias2)	1.689E-3	1.521E-3	1.579E-3	1.609E-3	1.646E-3	1.534E-3	1.455E-3	1.761E-3	1.362E-3	1.348E-3	1.377E-3
N° 9 (Bias2)	2.270E-4	1.599E-4	1.170E-4	1.262E-4	1.188E-4	1.292E-4	1.828E-4	1.286E-4	1.304E-4	1.306E-4	1.626E-4
N° 10 (Bias2)	2.320E-4	1.592E-4	1.207E-4	1.299E-4	1.237E-4	1.330E-4	1.767E-4	1.341E-4	1.383E-4	1.399E-4	1.748E-4
N° 11 (Bias2)	2.294E-4	1.636E-4	1.236E-4	1.321E-4	5.903E-3	1.367E-4	1.826E-4	1.415E-4	1.466E-4	1.432E-4	1.700E-4
N° 12 (OFF1)	3.073E-3	6.074E-3	3.378E-3	2.705E-3	3.307E-3	4.012E-3	3.533E-3	3.510E-3	2.879E-3	2.628E-3	4.570E-3
N° 13 (OFF1)	2.592E-4	1.794E-4	1.411E-4	1.456E-4	1.442E-4	1.484E-4	1.841E-4	1.435E-4	1.439E-4	1.494E-4	1.934E-4
N° 14 (OFF1)	4.603E-3	5.233E-3	5.659E-3	4.616E-3	5.633E-3	4.985E-3	6.322E-3	5.510E-3	4.427E-3	4.737E-3	6.219E-3
N° 15 (OFF1)	2.552E-4	1.836E-4	1.461E-4	1.478E-4	7.727E-4	1.491E-4	1.783E-4	1.395E-4	1.401E-4	1.464E-4	1.883E-4
N° 16 (OFF1)	2.244E-4	1.538E-4	1.148E-4	1.223E-4	1.160E-4	1.272E-4	1.648E-4	1.254E-4	1.214E-4	1.271E-4	1.734E-4

Delta [Ir]

	0krad(Si)	10krad(Si)	19krad(Si)	49krad(Si)	65krad(Si)	101krad(Si)	130krad(Si)	152krad(Si)	203krad(Si)	24h/25°C	168h/100°C
N° 1 (Ref)	---	-7.349E-5	-1.264E-4	-1.208E-4	-1.361E-4	-1.180E-4	-3.266E-5	-1.260E-4	-1.258E-4	-1.213E-4	1.518E-4
N° 2 (Bias1)	---	-5.536E-5	-1.012E-4	-8.635E-5	5.296E-3	1.679E-4	5.539E-4	-9.507E-5	-1.116E-4	-7.899E-5	8.810E-5
N° 3 (Bias1)	---	-3.906E-5	-8.854E-5	-7.487E-5	1.909E-3	-6.511E-5	4.004E-6	-8.815E-5	-8.587E-5	-6.443E-5	1.177E-4
N° 4 (Bias1)	---	-4.021E-5	-8.601E-5	-7.831E-5	5.427E-3	2.441E-4	3.905E-5	-8.998E-5	-9.087E-5	-8.786E-5	1.785E-4
N° 5 (Bias1)	---	-4.768E-5	-9.961E-5	-8.649E-5	1.183E-3	2.537E-4	4.106E-5	-9.187E-5	-9.639E-5	-8.171E-5	3.945E-5
N° 6 (Bias1)	---	-5.119E-5	-9.715E-5	-9.161E-5	-9.044E-5	-9.060E-5	-4.432E-5	-1.006E-4	-9.779E-5	-8.683E-5	-3.219E-5
N° 7 (Bias2)	---	-7.177E-5	-1.150E-4	-1.045E-4	-1.057E-4	-1.016E-4	-3.107E-5	-1.036E-4	-9.452E-5	-9.350E-5	5.088E-5
N° 8 (Bias2)	---	-1.679E-4	-1.097E-4	-7.958E-5	-4.272E-5	-1.547E-4	-2.331E-4	7.273E-5	-3.269E-4	-3.405E-4	-3.112E-4
N° 9 (Bias2)	---	-6.710E-5	-1.099E-4	-1.008E-4	-1.082E-4	-9.775E-5	-4.421E-5	-9.839E-5	-9.657E-5	-9.635E-5	-6.438E-5
N° 10 (Bias2)	---	-7.288E-5	-1.113E-4	-1.022E-4	-1.083E-4	-9.901E-5	-5.536E-5	-9.800E-5	-9.373E-5	-9.216E-5	-5.726E-5
N° 11 (Bias2)	---	-6.578E-5	-1.058E-4	-9.732E-5	5.673E-3	-9.272E-5	-4.682E-5	-8.785E-5	-8.278E-5	-8.616E-5	-5.938E-5
N° 12 (OFF1)	---	3.000E-3	3.043E-4	-3.687E-4	2.336E-4	9.381E-4	4.591E-4	4.361E-4	-1.942E-4	-4.449E-4	1.496E-3
N° 13 (OFF1)	---	-7.982E-5	-1.181E-4	-1.136E-4	-1.150E-4	-1.108E-4	-7.507E-5	-1.157E-4	-1.153E-4	-1.098E-4	-6.581E-5
N° 14 (OFF1)	---	6.301E-4	1.056E-3	1.349E-5	1.030E-3	3.821E-4	1.719E-3	9.076E-4	-1.755E-4	1.341E-4	1.616E-3
N° 15 (OFF1)	---	-7.162E-5	-1.091E-4	-1.074E-4	5.175E-4	-1.060E-4	-7.685E-5	-1.157E-4	-1.151E-4	-1.087E-4	-6.687E-5
N° 16 (OFF1)	---	-7.069E-5	-1.096E-4	-1.022E-4	-1.085E-4	-9.729E-5	-5.969E-5	-9.907E-5	-1.030E-4	-9.733E-5	-5.106E-5
Average (OFF1)	---	-4.670E-5	-9.451E-5	-8.353E-5	2.745E-3	1.020E-4	1.187E-4	-9.314E-5	-9.650E-5	-7.996E-5	7.831E-5
σ (OFF1)	---	7.011E-6	6.825E-6	6.787E-6	2.494E-3	1.677E-4	2.457E-4	4.902E-6	9.658E-6	9.420E-6	7.969E-5
Average+3σ (OFF1)	---	-2.567E-5	-7.404E-5	-6.317E-5	1.023E-2	6.052E-4	8.558E-4	-7.843E-5	-6.752E-5	-5.171E-5	3.174E-4
Average-3σ (OFF1)	---	-6.773E-5	-1.150E-4	-1.039E-4	-4.736E-3	-4.013E-4	-6.184E-4	-1.078E-4	-1.255E-4	-1.082E-4	-1.608E-4
Average (Bias1)	---	-8.909E-5	-1.104E-4	-9.688E-5	1.062E-3	-1.092E-4	-8.211E-5	-6.301E-5	-1.389E-4	-1.417E-4	-8.826E-5
σ (Bias1)	---	4.416E-5	3.312E-6	1.002E-5	2.578E-3	2.567E-5	8.485E-5	7.610E-5	1.052E-4	1.112E-4	1.336E-4
Average+3σ (Bias1)	---	4.340E-5	-1.004E-4	-6.682E-5	8.796E-3	-3.216E-5	1.724E-4	1.653E-4	1.768E-4	1.918E-4	3.126E-4
Average-3σ (Bias1)	---	-2.216E-4	-1.203E-4	-1.269E-4	-6.673E-3	-1.861E-4	-3.367E-4	-2.913E-4	-4.546E-4	-4.752E-4	-4.891E-4
Average (Bias2)	---	6.817E-4	2.048E-4	-1.357E-4	3.115E-4	2.012E-4	3.934E-4	2.027E-4	-1.406E-4	-1.253E-4	5.857E-4
σ (Bias2)	---	1.332E-3	5.091E-4	1.405E-4	4.803E-4	4.628E-4	7.759E-4	4.597E-4	4.120E-5	2.066E-4	8.869E-4
Average+3σ (Bias2)	---	4.676E-3	1.732E-3	2.858E-4	1.752E-3	1.590E-3	2.721E-3	1.582E-3	-1.702E-5	4.945E-4	3.246E-3
Average-3σ (Bias2)	---	-3.313E-3	-1.323E-3	-5.572E-4	-1.129E-3	-1.187E-3	-1.934E-3	-1.176E-3	-2.642E-4	-7.452E-4	-2.075E-3

2. VF

Ta=25°C; If = 10 mA

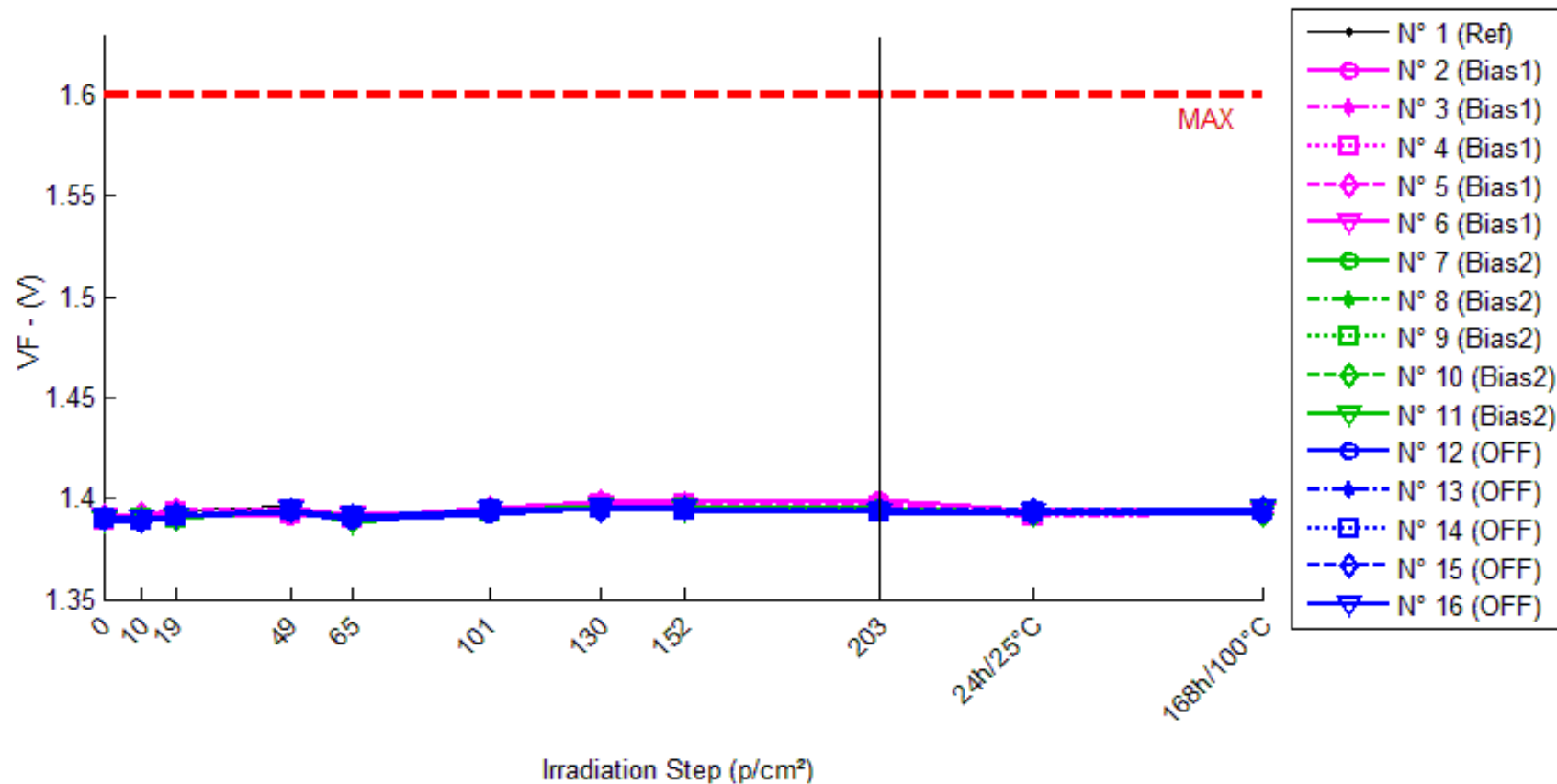

VF . (V)

Max = 1.6

	0krad(Si)	10krad(Si)	19krad(Si)	49krad(Si)	65krad(Si)	101krad(Si)	130krad(Si)	152krad(Si)	203krad(Si)	24h/25°C	168h/100°C
N° 1 (Ref)	1.391	1.391	1.394	1.396	1.391	1.394	1.397	1.395	1.394	1.393	1.395
N° 2 (Bias1)	1.391	1.392	1.391	1.391	1.391	1.395	1.398	1.398	1.399	1.394	1.395
N° 3 (Bias1)	1.390	1.391	1.393	1.393	1.391	1.394	1.397	1.398	1.398	1.391	1.393
N° 4 (Bias1)	1.389	1.390	1.393	1.392	1.390	1.394	1.397	1.397	1.396	1.391	1.394
N° 5 (Bias1)	1.391	1.392	1.394	1.394	1.391	1.395	1.398	1.397	1.397	1.392	1.393
N° 6 (Bias1)	1.391	1.390	1.390	1.395	1.392	1.394	1.397	1.396	1.395	1.393	1.393
N° 7 (Bias2)	1.390	1.390	1.391	1.394	1.390	1.393	1.396	1.395	1.395	1.393	1.394
N° 8 (Bias2)	1.390	1.390	1.390	1.394	1.391	1.393	1.396	1.394	1.395	1.393	1.393
N° 9 (Bias2)	1.390	1.390	1.390	1.394	1.391	1.393	1.395	1.395	1.393	1.393	1.394
N° 10 (Bias2)	1.390	1.390	1.390	1.394	1.390	1.394	1.394	1.395	1.394	1.392	1.392
N° 11 (Bias2)	1.389	1.390	1.390	1.394	1.388	1.394	1.396	1.394	1.393	1.393	1.394
N° 12 (OFF1)	1.389	1.388	1.391	1.393	1.389	1.392	1.395	1.394	1.393	1.392	1.392
N° 13 (OFF1)	1.391	1.388	1.392	1.394	1.389	1.394	1.395	1.394	1.394	1.393	1.393
N° 14 (OFF1)	1.390	1.389	1.391	1.394	1.391	1.394	1.395	1.394	1.393	1.393	1.394
N° 15 (OFF1)	1.390	1.389	1.392	1.394	1.391	1.394	1.394	1.395	1.394	1.394	1.395
N° 16 (OFF1)	1.390	1.390	1.391	1.394	1.391	1.394	1.395	1.395	1.393	1.393	1.395

Delta [VF]

	0krad(Si)	10krad(Si)	19krad(Si)	49krad(Si)	65krad(Si)	101krad(Si)	130krad(Si)	152krad(Si)	203krad(Si)	24h/25°C	168h/100°C
N° 1 (Ref)	---	-2.580E-4	2.619E-3	4.641E-3	2.720E-4	2.565E-3	5.895E-3	4.012E-3	2.621E-3	1.683E-3	3.890E-3
N° 2 (Bias1)	---	2.010E-4	-4.520E-4	-4.810E-4	-9.470E-4	3.018E-3	6.214E-3	6.706E-3	7.677E-3	2.066E-3	3.769E-3
N° 3 (Bias1)	---	1.416E-3	3.491E-3	2.761E-3	1.005E-3	4.471E-3	7.243E-3	7.756E-3	7.891E-3	9.040E-4	3.607E-3
N° 4 (Bias1)	---	1.357E-3	3.621E-3	3.096E-3	8.060E-4	4.940E-3	7.845E-3	8.084E-3	7.296E-3	1.996E-3	4.564E-3
N° 5 (Bias1)	---	1.011E-3	3.080E-3	2.715E-3	1.720E-4	4.058E-3	6.955E-3	6.592E-3	5.887E-3	1.206E-3	1.691E-3
N° 6 (Bias1)	---	-1.600E-4	-1.250E-4	4.105E-3	1.016E-3	3.623E-3	6.164E-3	5.789E-3	4.738E-3	2.314E-3	2.837E-3
N° 7 (Bias2)	---	4.190E-4	9.920E-4	4.676E-3	3.250E-4	3.523E-3	6.156E-3	5.402E-3	4.829E-3	2.794E-3	3.922E-3
N° 8 (Bias2)	---	-3.510E-4	1.470E-4	4.308E-3	1.368E-3	2.829E-3	5.927E-3	4.385E-3	4.452E-3	2.690E-3	3.316E-3
N° 9 (Bias2)	---	3.100E-5	5.260E-4	3.962E-3	1.370E-3	3.574E-3	4.935E-3	4.930E-3	3.730E-3	3.156E-3	4.394E-3
N° 10 (Bias2)	---	3.160E-4	3.400E-4	4.136E-3	-1.580E-4	3.638E-3	4.281E-3	4.797E-3	3.873E-3	1.803E-3	2.145E-3
N° 11 (Bias2)	---	5.920E-4	1.421E-3	5.179E-3	-6.180E-4	4.512E-3	6.874E-3	5.424E-3	4.023E-3	4.189E-3	5.299E-3
N° 12 (OFF1)	---	-1.246E-3	1.170E-3	3.832E-3	-2.220E-4	2.963E-3	5.464E-3	4.105E-3	3.456E-3	2.453E-3	2.952E-3
N° 13 (OFF1)	---	-2.365E-3	7.690E-4	3.598E-3	-1.832E-3	3.496E-3	4.668E-3	3.633E-3	3.225E-3	2.698E-3	2.176E-3
N° 14 (OFF1)	---	-1.000E-3	7.490E-4	3.771E-3	4.490E-4	3.755E-3	5.051E-3	4.146E-3	3.042E-3	2.960E-3	3.838E-3
N° 15 (OFF1)	---	-1.155E-3	2.012E-3	4.253E-3	7.300E-4	4.324E-3	4.436E-3	4.751E-3	3.482E-3	3.890E-3	5.338E-3
N° 16 (OFF1)	---	-7.280E-4	7.760E-4	3.791E-3	8.170E-4	3.486E-3	4.339E-3	4.406E-3	2.594E-3	2.308E-3	4.995E-3
Average (OFF1)	---	7.650E-4	1.923E-3	2.439E-3	4.104E-4	4.022E-3	6.884E-3	6.985E-3	6.698E-3	1.697E-3	3.294E-3
σ (OFF1)	---	7.086E-4	2.032E-3	1.726E-3	8.331E-4	7.438E-4	7.115E-4	9.307E-4	1.345E-3	6.075E-4	1.086E-3
Average+3σ (OFF1)	---	2.891E-3	8.019E-3	7.617E-3	2.910E-3	6.253E-3	9.019E-3	9.778E-3	1.073E-2	3.520E-3	6.551E-3
Average-3σ (OFF1)	---	-1.361E-3	-4.173E-3	-2.738E-3	-2.089E-3	1.791E-3	4.750E-3	4.193E-3	2.662E-3	-1.253E-4	3.651E-5
Average (Bias1)	---	2.014E-4	6.852E-4	4.452E-3	4.574E-4	3.615E-3	5.635E-3	4.988E-3	4.181E-3	2.926E-3	3.815E-3
σ (Bias1)	---	3.699E-4	5.171E-4	4.846E-4	8.965E-4	5.986E-4	1.027E-3	4.373E-4	4.518E-4	8.635E-4	1.182E-3
Average+3σ (Bias1)	---	1.311E-3	2.237E-3	5.906E-3	3.147E-3	5.411E-3	8.714E-3	6.300E-3	5.537E-3	5.517E-3	7.361E-3
Average-3σ (Bias1)	---	-9.082E-4	-8.662E-4	2.998E-3	-2.232E-3	1.820E-3	2.555E-3	3.676E-3	2.826E-3	3.360E-4	2.697E-4
Average (Bias2)	---	-1.299E-3	1.095E-3	3.849E-3	-1.160E-5	3.605E-3	4.792E-3	4.208E-3	3.160E-3	2.862E-3	3.860E-3
σ (Bias2)	---	6.276E-4	5.418E-4	2.429E-4	1.096E-3	4.944E-4	4.653E-4	4.120E-4	3.639E-4	6.260E-4	1.335E-3
Average+3σ (Bias2)	---	5.839E-4	2.721E-3	4.578E-3	3.277E-3	5.088E-3	6.187E-3	5.444E-3	4.252E-3	4.740E-3	7.866E-3
Average-3σ (Bias2)	---	-3.181E-3	-5.303E-4	3.120E-3	-3.300E-3	2.122E-3	3.396E-3	2.972E-3	2.068E-3	9.838E-4	-1.465E-4

3. V(BR)cbo

Ta=25°C; Ic = 100 µA; Ib = 0; If = 0

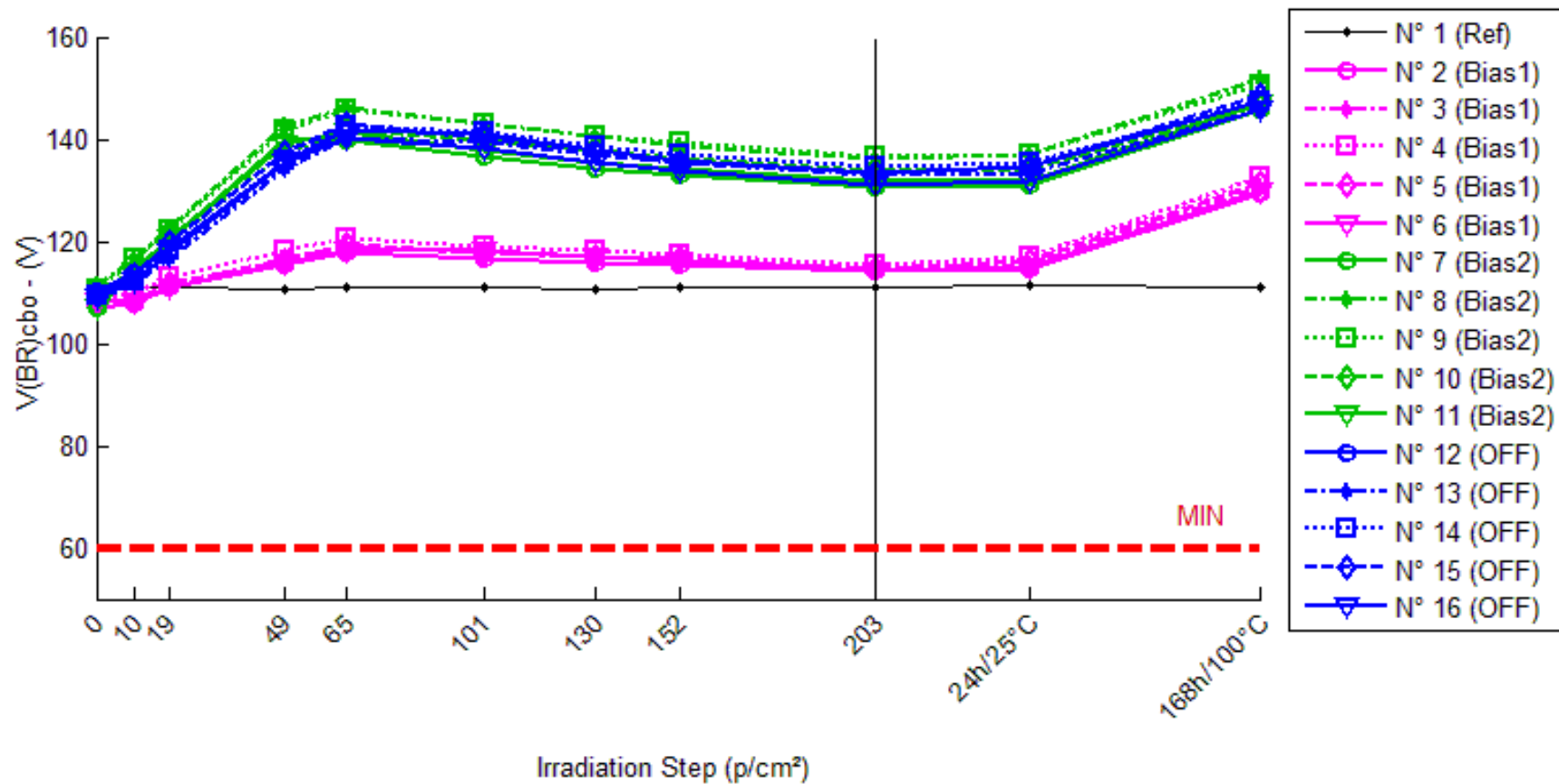

V(BR)cho . (V)

Min = 60.0

	0krad(Si)	10krad(Si)	19krad(Si)	49krad(Si)	65krad(Si)	101krad(Si)	130krad(Si)	152krad(Si)	203krad(Si)	24h/25°C	168h/100°C
N° 1 (Ref)	110.7	110.9	110.9	110.7	111.0	110.8	110.7	111.0	111.2	111.2	111.1
N° 2 (Bias1)	107.0	107.6	110.9	115.3	117.7	116.6	115.9	115.2	114.2	114.8	129.6
N° 3 (Bias1)	106.9	108.2	111.5	116.5	118.8	117.9	117.2	116.5	114.4	115.6	130.6
N° 4 (Bias1)	108.7	109.6	113.2	118.0	120.7	119.1	118.3	117.6	115.4	116.8	132.4
N° 5 (Bias1)	107.9	108.2	111.9	116.3	119.3	117.9	117.2	116.6	114.5	116.0	131.5
N° 6 (Bias1)	108.3	108.4	110.9	115.7	118.4	118.3	116.8	116.1	114.0	115.1	129.6
N° 7 (Bias2)	106.8	114.2	120.2	139.8	139.9	136.6	134.2	132.9	130.5	130.8	145.7
N° 8 (Bias2)	111.3	116.5	122.5	142.7	146.0	143.0	140.5	138.8	136.3	136.9	151.9
N° 9 (Bias2)	110.6	116.5	122.4	141.9	145.7	143.0	140.6	139.3	136.7	137.1	150.6
N° 10 (Bias2)	109.8	114.4	119.9	137.4	141.8	140.0	137.8	136.4	133.8	134.1	146.8
N° 11 (Bias2)	106.8	114.2	120.6	139.1	141.3	137.8	135.4	134.1	131.7	131.9	147.0
N° 12 (OFF1)	110.4	113.6	118.4	135.4	141.9	141.1	137.6	135.8	133.5	134.5	147.5
N° 13 (OFF1)	108.4	111.7	116.6	134.2	140.1	139.4	136.9	135.2	133.1	133.6	145.9
N° 14 (OFF1)	109.3	112.0	118.1	135.9	142.6	141.6	138.5	137.0	134.5	135.3	147.6
N° 15 (OFF1)	109.3	113.3	119.7	137.3	142.8	140.4	137.4	135.2	133.5	134.5	148.6
N° 16 (OFF1)	109.2	112.0	117.9	135.5	140.2	138.2	135.3	133.6	131.2	131.9	145.7

Delta [V(BR)cbo]

	0krad(Si)	10krad(Si)	19krad(Si)	49krad(Si)	65krad(Si)	101krad(Si)	130krad(Si)	152krad(Si)	203krad(Si)	24h/25°C	168h/100°C
N° 1 (Ref)	---	1.961E-1	1.922E-1	-3.630E-2	3.287E-1	1.135E-1	-3.140E-2	2.551E-1	4.454E-1	5.117E-1	3.611E-1
N° 2 (Bias1)	---	6.456E-1	3.908E+0	8.300E+0	1.075E+1	9.620E+0	8.887E+0	8.223E+0	7.205E+0	7.757E+0	2.260E+1
N° 3 (Bias1)	---	1.314E+0	4.617E+0	9.660E+0	1.195E+1	1.097E+1	1.028E+1	9.628E+0	7.529E+0	8.711E+0	2.376E+1
N° 4 (Bias1)	---	9.197E-1	4.442E+0	9.320E+0	1.199E+1	1.044E+1	9.621E+0	8.867E+0	6.660E+0	8.108E+0	2.371E+1
N° 5 (Bias1)	---	2.949E-1	4.046E+0	8.484E+0	1.142E+1	1.000E+1	9.297E+0	8.701E+0	6.626E+0	8.144E+0	2.363E+1
N° 6 (Bias1)	---	1.115E-1	2.665E+0	7.415E+0	1.010E+1	1.005E+1	8.538E+0	7.817E+0	5.756E+0	6.838E+0	2.132E+1
N° 7 (Bias2)	---	7.381E+0	1.340E+1	3.296E+1	3.310E+1	2.975E+1	2.736E+1	2.612E+1	2.373E+1	2.403E+1	3.885E+1
N° 8 (Bias2)	---	5.244E+0	1.117E+1	3.137E+1	3.471E+1	3.167E+1	2.919E+1	2.749E+1	2.497E+1	2.557E+1	4.063E+1
N° 9 (Bias2)	---	5.936E+0	1.178E+1	3.134E+1	3.515E+1	3.240E+1	3.004E+1	2.871E+1	2.611E+1	2.658E+1	4.003E+1
N° 10 (Bias2)	---	4.591E+0	1.014E+1	2.758E+1	3.203E+1	3.022E+1	2.800E+1	2.658E+1	2.403E+1	2.431E+1	3.700E+1
N° 11 (Bias2)	---	7.364E+0	1.374E+1	3.232E+1	3.445E+1	3.094E+1	2.862E+1	2.726E+1	2.484E+1	2.506E+1	4.014E+1
N° 12 (OFF1)	---	3.266E+0	8.052E+0	2.504E+1	3.148E+1	3.070E+1	2.728E+1	2.545E+1	2.311E+1	2.409E+1	3.713E+1
N° 13 (OFF1)	---	3.291E+0	8.214E+0	2.581E+1	3.171E+1	3.103E+1	2.844E+1	2.683E+1	2.470E+1	2.515E+1	3.752E+1
N° 14 (OFF1)	---	2.747E+0	8.846E+0	2.660E+1	3.336E+1	3.230E+1	2.924E+1	2.774E+1	2.523E+1	2.607E+1	3.833E+1
N° 15 (OFF1)	---	3.935E+0	1.032E+1	2.799E+1	3.348E+1	3.106E+1	2.808E+1	2.591E+1	2.416E+1	2.517E+1	3.923E+1
N° 16 (OFF1)	---	2.866E+0	8.735E+0	2.634E+1	3.102E+1	2.902E+1	2.614E+1	2.444E+1	2.201E+1	2.275E+1	3.655E+1
Average (OFF1)	---	6.570E-1	3.936E+0	8.636E+0	1.124E+1	1.022E+1	9.324E+0	8.647E+0	6.755E+0	7.912E+0	2.300E+1
σ (OFF1)	---	4.819E-1	7.662E-1	8.868E-1	8.146E-1	5.125E-1	6.718E-1	6.860E-1	6.754E-1	6.907E-1	1.056E+0
Average+3 σ (OFF1)	---	2.103E+0	6.234E+0	1.130E+1	1.369E+1	1.175E+1	1.134E+1	1.071E+1	8.781E+0	9.984E+0	2.617E+1
Average-3 σ (OFF1)	---	-7.886E-1	1.637E+0	5.975E+0	8.798E+0	8.679E+0	7.309E+0	6.589E+0	4.729E+0	5.840E+0	1.984E+1
Average (Bias1)	---	6.103E+0	1.205E+1	3.112E+1	3.389E+1	3.100E+1	2.864E+1	2.723E+1	2.474E+1	2.511E+1	3.933E+1
σ (Bias1)	---	1.253E+0	1.514E+0	2.092E+0	1.290E+0	1.070E+0	1.041E+0	9.905E-1	9.325E-1	1.024E+0	1.457E+0
Average+3 σ (Bias1)	---	9.861E+0	1.659E+1	3.739E+1	3.776E+1	3.420E+1	3.176E+1	3.020E+1	2.753E+1	2.818E+1	4.370E+1
Average-3 σ (Bias1)	---	2.345E+0	7.504E+0	2.484E+1	3.002E+1	2.779E+1	2.552E+1	2.426E+1	2.194E+1	2.204E+1	3.496E+1
Average (Bias2)	---	3.221E+0	8.834E+0	2.635E+1	3.221E+1	3.082E+1	2.783E+1	2.607E+1	2.384E+1	2.465E+1	3.775E+1
σ (Bias2)	---	4.656E-1	8.983E-1	1.090E+0	1.131E+0	1.175E+0	1.181E+0	1.269E+0	1.289E+0	1.271E+0	1.050E+0
Average+3 σ (Bias2)	---	4.618E+0	1.153E+1	2.963E+1	3.560E+1	3.435E+1	3.138E+1	2.988E+1	2.771E+1	2.846E+1	4.090E+1
Average-3 σ (Bias2)	---	1.824E+0	6.140E+0	2.308E+1	2.882E+1	2.730E+1	2.429E+1	2.227E+1	1.997E+1	2.083E+1	3.460E+1

4. V(BR)_{ceo}

T_a=25°C; I_c = 1 mA; I_b = 0; I_f = 0

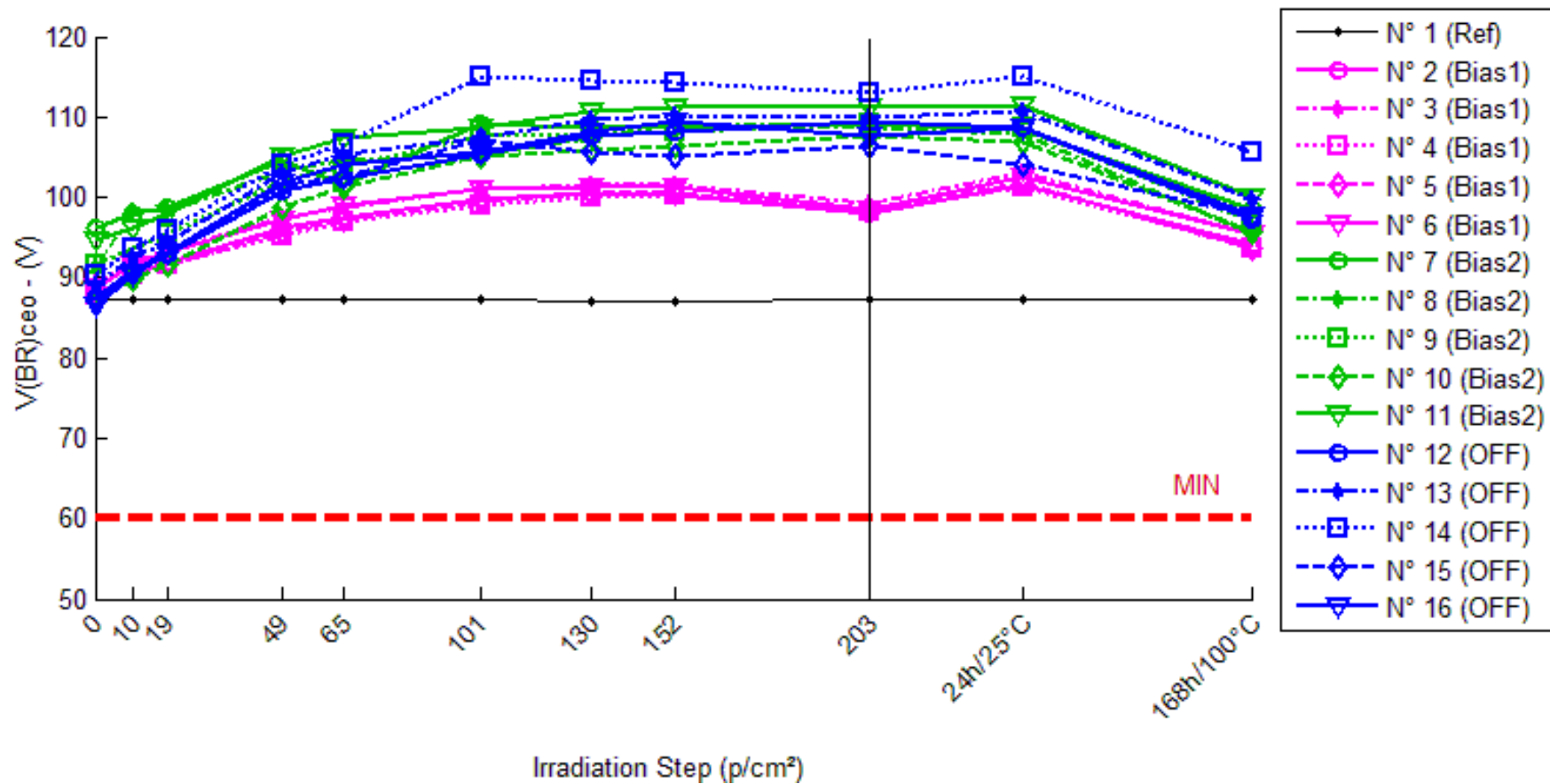

V(BR)ceo . (V)

Min = 60.0

	0krad(Si)	10krad(Si)	19krad(Si)	49krad(Si)	65krad(Si)	101krad(Si)	130krad(Si)	152krad(Si)	203krad(Si)	24h/25°C	168h/100°C
N° 1 (Ref)	87.2	87.4	87.3	87.2	87.4	87.3	87.1	87.1	87.2	87.2	87.2
N° 2 (Bias1)	87.7	90.3	92.0	96.2	97.4	99.8	100.4	100.3	97.9	101.6	94.2
N° 3 (Bias1)	89.3	91.9	93.3	97.5	98.7	101.0	101.7	101.6	99.3	103.2	95.5
N° 4 (Bias1)	87.9	90.2	91.6	95.3	96.9	99.0	99.9	100.2	98.4	101.2	93.8
N° 5 (Bias1)	87.0	89.8	91.6	95.8	97.2	99.6	100.6	100.6	98.4	101.9	93.8
N° 6 (Bias1)	88.9	91.7	93.1	97.2	98.9	101.1	101.4	101.4	98.5	102.6	95.4
N° 7 (Bias2)	96.3	98.0	98.8	104.6	101.6	109.2	108.6	108.7	109.2	108.4	98.6
N° 8 (Bias2)	91.2	98.3	98.3	103.2	104.5	105.3	107.4	109.1	108.7	108.0	95.4
N° 9 (Bias2)	91.7	93.7	95.4	102.1	103.9	107.7	107.8	108.2	109.3	108.7	97.0
N° 10 (Bias2)	87.0	89.8	91.6	98.7	101.3	105.2	105.8	106.3	107.6	106.9	95.6
N° 11 (Bias2)	94.6	96.2	98.1	105.1	107.4	108.8	110.8	111.2	111.3	111.4	99.9
N° 12 (OFF1)	87.6	90.9	92.8	100.8	102.3	105.4	107.8	108.1	109.3	108.6	97.2
N° 13 (OFF1)	89.0	92.6	94.5	103.0	105.5	107.4	109.7	110.2	109.9	110.7	99.8
N° 14 (OFF1)	90.4	93.6	95.8	104.2	106.5	115.2	114.6	114.4	113.1	115.0	105.7
N° 15 (OFF1)	87.3	90.8	93.1	101.5	102.6	107.1	105.5	105.2	106.4	104.2	97.6
N° 16 (OFF1)	86.6	90.4	93.1	101.7	104.0	105.6	108.1	109.3	107.8	108.6	97.7

Delta [V(BR)ceo]

	0krad(Si)	10krad(Si)	19krad(Si)	49krad(Si)	65krad(Si)	101krad(Si)	130krad(Si)	152krad(Si)	203krad(Si)	24h/25°C	168h/100°C
N° 1 (Ref)	---	1.491E-1	9.485E-2	2.640E-3	1.534E-1	6.610E-2	-1.369E-1	-6.121E-2	3.250E-3	1.443E-2	-1.763E-2
N° 2 (Bias1)	---	2.636E+0	4.305E+0	8.532E+0	9.667E+0	1.209E+1	1.273E+1	1.264E+1	1.024E+1	1.387E+1	6.466E+0
N° 3 (Bias1)	---	2.553E+0	4.023E+0	8.152E+0	9.384E+0	1.175E+1	1.237E+1	1.229E+1	9.953E+0	1.385E+1	6.155E+0
N° 4 (Bias1)	---	2.310E+0	3.639E+0	7.375E+0	8.955E+0	1.103E+1	1.199E+1	1.227E+1	1.044E+1	1.327E+1	5.854E+0
N° 5 (Bias1)	---	2.806E+0	4.588E+0	8.822E+0	1.020E+1	1.264E+1	1.358E+1	1.365E+1	1.139E+1	1.491E+1	6.796E+0
N° 6 (Bias1)	---	2.776E+0	4.157E+0	8.237E+0	9.983E+0	1.214E+1	1.247E+1	1.244E+1	9.548E+0	1.366E+1	6.431E+0
N° 7 (Bias2)	---	1.626E+0	2.435E+0	8.246E+0	5.285E+0	1.291E+1	1.228E+1	1.232E+1	1.284E+1	1.207E+1	2.241E+0
N° 8 (Bias2)	---	7.082E+0	7.088E+0	1.196E+1	1.328E+1	1.407E+1	1.612E+1	1.783E+1	1.744E+1	1.674E+1	4.121E+0
N° 9 (Bias2)	---	1.975E+0	3.715E+0	1.035E+1	1.214E+1	1.598E+1	1.606E+1	1.647E+1	1.754E+1	1.693E+1	5.240E+0
N° 10 (Bias2)	---	2.879E+0	4.652E+0	1.172E+1	1.429E+1	1.826E+1	1.886E+1	1.933E+1	2.063E+1	1.993E+1	8.625E+0
N° 11 (Bias2)	---	1.610E+0	3.457E+0	1.051E+1	1.283E+1	1.420E+1	1.621E+1	1.659E+1	1.671E+1	1.679E+1	5.311E+0
N° 12 (OFF1)	---	3.301E+0	5.225E+0	1.323E+1	1.465E+1	1.777E+1	2.016E+1	2.047E+1	2.172E+1	2.101E+1	9.612E+0
N° 13 (OFF1)	---	3.630E+0	5.519E+0	1.396E+1	1.648E+1	1.844E+1	2.074E+1	2.118E+1	2.089E+1	2.171E+1	1.079E+1
N° 14 (OFF1)	---	3.151E+0	5.405E+0	1.378E+1	1.613E+1	2.473E+1	2.420E+1	2.398E+1	2.270E+1	2.459E+1	1.528E+1
N° 15 (OFF1)	---	3.457E+0	5.719E+0	1.412E+1	1.522E+1	1.978E+1	1.819E+1	1.785E+1	1.906E+1	1.683E+1	1.031E+1
N° 16 (OFF1)	---	3.757E+0	6.446E+0	1.507E+1	1.739E+1	1.897E+1	2.143E+1	2.270E+1	2.116E+1	2.202E+1	1.109E+1
Average (OFF1)	---	2.616E+0	4.142E+0	8.223E+0	9.638E+0	1.193E+1	1.263E+1	1.266E+1	1.031E+1	1.391E+1	6.340E+0
σ (OFF1)	---	1.999E-1	3.508E-1	5.430E-1	4.920E-1	5.958E-1	5.932E-1	5.760E-1	6.881E-1	6.105E-1	3.546E-1
Average+3σ (OFF1)	---	3.216E+0	5.195E+0	9.852E+0	1.111E+1	1.372E+1	1.441E+1	1.439E+1	1.238E+1	1.574E+1	7.404E+0
Average-3σ (OFF1)	---	2.017E+0	3.090E+0	6.595E+0	8.162E+0	1.014E+1	1.085E+1	1.093E+1	8.250E+0	1.208E+1	5.276E+0
Average (Bias1)	---	3.034E+0	4.269E+0	1.056E+1	1.157E+1	1.509E+1	1.591E+1	1.651E+1	1.703E+1	1.649E+1	5.108E+0
σ (Bias1)	---	2.321E+0	1.762E+0	1.475E+0	3.597E+0	2.087E+0	2.346E+0	2.608E+0	2.788E+0	2.818E+0	2.325E+0
Average+3σ (Bias1)	---	9.996E+0	9.557E+0	1.498E+1	2.236E+1	2.135E+1	2.294E+1	2.433E+1	2.540E+1	2.495E+1	1.208E+1
Average-3σ (Bias1)	---	-3.928E+0	-1.018E+0	6.130E+0	7.743E-1	8.826E+0	8.869E+0	8.684E+0	8.668E+0	8.038E+0	-1.868E+0
Average (Bias2)	---	3.459E+0	5.663E+0	1.403E+1	1.597E+1	1.994E+1	2.095E+1	2.124E+1	2.111E+1	2.123E+1	1.142E+1
σ (Bias2)	---	2.439E-1	4.729E-1	6.712E-1	1.072E+0	2.780E+0	2.182E+0	2.333E+0	1.335E+0	2.808E+0	2.231E+0
Average+3σ (Bias2)	---	4.191E+0	7.081E+0	1.605E+1	1.919E+1	2.828E+1	2.749E+1	2.823E+1	2.511E+1	2.966E+1	1.811E+1
Average-3σ (Bias2)	---	2.727E+0	4.244E+0	1.202E+1	1.276E+1	1.160E+1	1.440E+1	1.424E+1	1.710E+1	1.281E+1	4.725E+0

5. V(BR)_{eco}

T_a=25°C; I_c = 0; I_e = 100 μA; I_f = 0

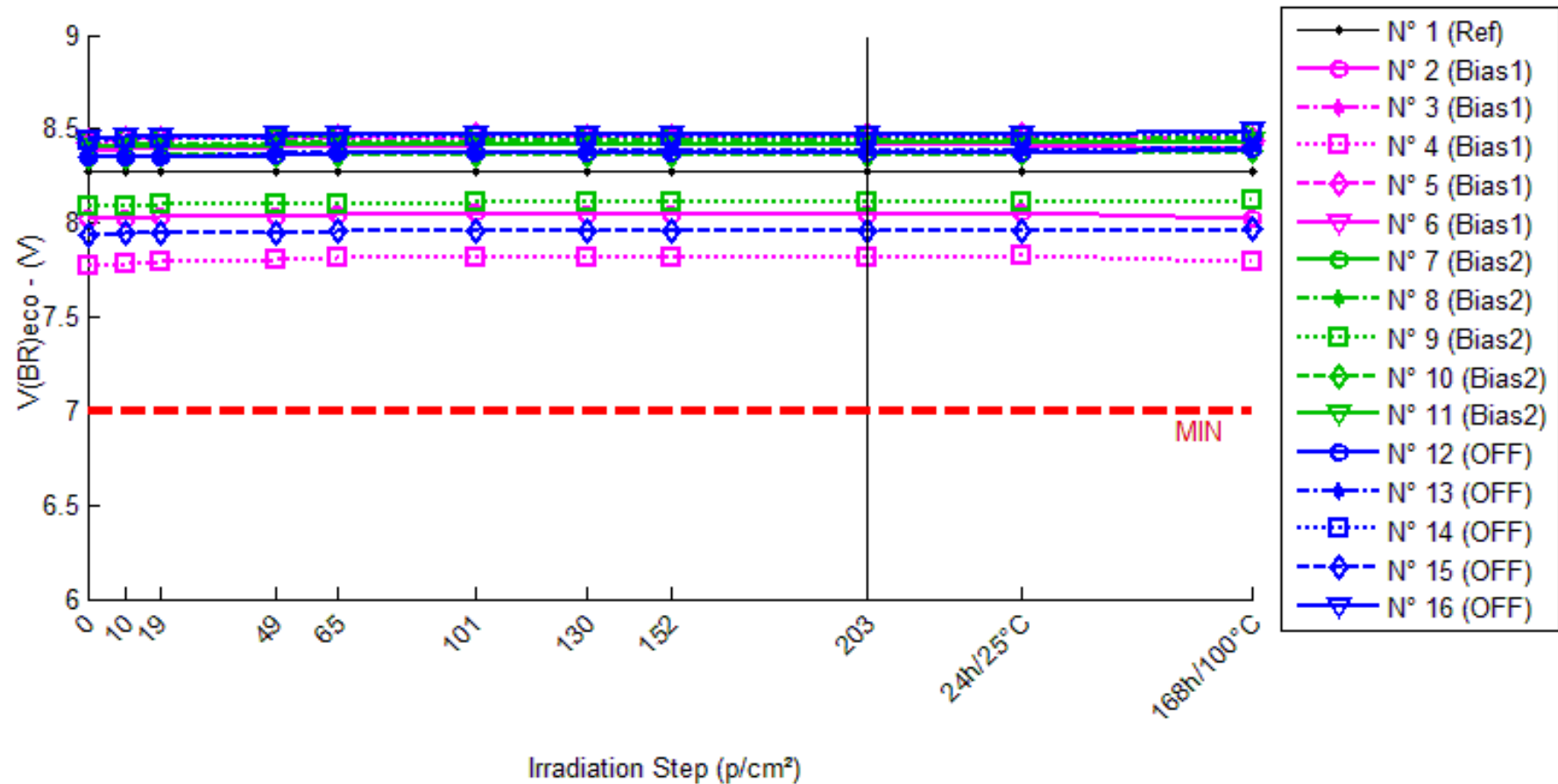

V(BR)eco . (V)

Min = 7.0

	0krad(Si)	10krad(Si)	19krad(Si)	49krad(Si)	65krad(Si)	101krad(Si)	130krad(Si)	152krad(Si)	203krad(Si)	24h/25°C	168h/100°C
N° 1 (Ref)	8.273	8.274	8.273	8.270	8.276	8.272	8.270	8.271	8.272	8.273	8.271
N° 2 (Bias1)	8.022	8.028	8.030	8.040	8.047	8.051	8.050	8.050	8.050	8.057	8.029
N° 3 (Bias1)	8.416	8.419	8.421	8.430	8.436	8.441	8.443	8.444	8.447	8.453	8.423
N° 4 (Bias1)	7.773	7.788	7.793	7.804	7.811	7.819	7.818	7.819	7.817	7.825	7.797
N° 5 (Bias1)	8.438	8.444	8.446	8.453	8.460	8.466	8.464	8.465	8.468	8.473	8.449
N° 6 (Bias1)	8.389	8.395	8.397	8.402	8.410	8.414	8.412	8.413	8.415	8.418	8.396
N° 7 (Bias2)	8.452	8.460	8.461	8.464	8.472	8.474	8.471	8.472	8.473	8.475	8.495
N° 8 (Bias2)	8.404	8.414	8.416	8.422	8.428	8.433	8.433	8.436	8.439	8.441	8.458
N° 9 (Bias2)	8.087	8.094	8.095	8.103	8.104	8.107	8.107	8.107	8.109	8.109	8.118
N° 10 (Bias2)	8.348	8.355	8.357	8.360	8.365	8.367	8.366	8.366	8.367	8.370	8.389
N° 11 (Bias2)	8.403	8.407	8.407	8.411	8.419	8.419	8.418	8.420	8.423	8.423	8.436
N° 12 (OFF1)	8.346	8.355	8.355	8.364	8.369	8.372	8.370	8.371	8.373	8.374	8.393
N° 13 (OFF1)	8.347	8.356	8.356	8.370	8.376	8.378	8.379	8.383	8.386	8.387	8.407
N° 14 (OFF1)	8.443	8.451	8.450	8.455	8.461	8.460	8.459	8.460	8.462	8.462	8.486
N° 15 (OFF1)	7.938	7.943	7.944	7.949	7.954	7.957	7.959	7.957	7.957	7.956	7.964
N° 16 (OFF1)	8.452	8.462	8.461	8.467	8.472	8.473	8.473	8.473	8.475	8.475	8.498

Delta [V(BR)eco]

	0krad(Si)	10krad(Si)	19krad(Si)	49krad(Si)	65krad(Si)	101krad(Si)	130krad(Si)	152krad(Si)	203krad(Si)	24h/25°C	168h/100°C
N° 1 (Ref)	---	1.049E-3	4.480E-4	-2.478E-3	3.066E-3	-7.220E-4	-2.528E-3	-1.956E-3	-8.760E-4	-1.900E-4	-2.231E-3
N° 2 (Bias1)	---	5.566E-3	8.293E-3	1.814E-2	2.447E-2	2.924E-2	2.740E-2	2.803E-2	2.780E-2	3.473E-2	7.147E-3
N° 3 (Bias1)	---	2.547E-3	4.681E-3	1.323E-2	2.002E-2	2.500E-2	2.615E-2	2.741E-2	3.059E-2	3.691E-2	6.950E-3
N° 4 (Bias1)	---	1.532E-2	1.975E-2	3.071E-2	3.843E-2	4.603E-2	4.539E-2	4.654E-2	4.461E-2	5.207E-2	2.405E-2
N° 5 (Bias1)	---	5.993E-3	7.699E-3	1.474E-2	2.144E-2	2.800E-2	2.547E-2	2.704E-2	2.950E-2	3.487E-2	1.118E-2
N° 6 (Bias1)	---	6.399E-3	8.247E-3	1.319E-2	2.140E-2	2.587E-2	2.366E-2	2.425E-2	2.591E-2	2.911E-2	7.778E-3
N° 7 (Bias2)	---	7.690E-3	9.183E-3	1.235E-2	2.054E-2	2.185E-2	1.949E-2	2.009E-2	2.121E-2	2.355E-2	4.285E-2
N° 8 (Bias2)	---	9.665E-3	1.173E-2	1.812E-2	2.360E-2	2.881E-2	2.915E-2	3.181E-2	3.480E-2	3.728E-2	5.377E-2
N° 9 (Bias2)	---	6.199E-3	7.762E-3	1.554E-2	1.646E-2	1.957E-2	1.946E-2	1.997E-2	2.123E-2	2.217E-2	3.037E-2
N° 10 (Bias2)	---	7.000E-3	8.441E-3	1.137E-2	1.732E-2	1.892E-2	1.835E-2	1.804E-2	1.927E-2	2.158E-2	4.050E-2
N° 11 (Bias2)	---	4.844E-3	4.780E-3	8.929E-3	1.652E-2	1.643E-2	1.544E-2	1.757E-2	2.085E-2	2.088E-2	3.345E-2
N° 12 (OFF1)	---	9.849E-3	9.903E-3	1.819E-2	2.376E-2	2.610E-2	2.458E-2	2.570E-2	2.750E-2	2.839E-2	4.699E-2
N° 13 (OFF1)	---	8.606E-3	8.703E-3	2.291E-2	2.859E-2	3.063E-2	3.222E-2	3.558E-2	3.917E-2	3.968E-2	5.995E-2
N° 14 (OFF1)	---	8.096E-3	7.052E-3	1.217E-2	1.791E-2	1.744E-2	1.627E-2	1.705E-2	1.858E-2	1.853E-2	4.272E-2
N° 15 (OFF1)	---	5.372E-3	5.632E-3	1.129E-2	1.576E-2	1.916E-2	2.071E-2	1.956E-2	1.889E-2	1.853E-2	2.598E-2
N° 16 (OFF1)	---	9.164E-3	8.708E-3	1.490E-2	1.998E-2	2.085E-2	2.083E-2	2.065E-2	2.233E-2	2.286E-2	4.550E-2
Average (OFF1)	---	7.164E-3	9.734E-3	1.800E-2	2.515E-2	3.083E-2	2.961E-2	3.065E-2	3.168E-2	3.754E-2	1.142E-2
σ (OFF1)	---	4.803E-3	5.794E-3	7.386E-3	7.598E-3	8.660E-3	8.924E-3	8.999E-3	7.441E-3	8.626E-3	7.262E-3
Average+3σ (OFF1)	---	2.157E-2	2.711E-2	4.016E-2	4.794E-2	5.681E-2	5.639E-2	5.765E-2	5.400E-2	6.342E-2	3.321E-2
Average-3σ (OFF1)	---	-7.245E-3	-7.647E-3	-4.157E-3	2.358E-3	4.847E-3	2.843E-3	3.657E-3	9.360E-3	1.166E-2	-1.037E-2
Average (Bias1)	---	7.080E-3	8.380E-3	1.326E-2	1.889E-2	2.112E-2	2.038E-2	2.150E-2	2.347E-2	2.509E-2	4.019E-2
σ (Bias1)	---	1.791E-3	2.511E-3	3.605E-3	3.118E-3	4.714E-3	5.171E-3	5.873E-3	6.382E-3	6.883E-3	9.128E-3
Average+3σ (Bias1)	---	1.245E-2	1.591E-2	2.408E-2	2.824E-2	3.526E-2	3.589E-2	3.912E-2	4.262E-2	4.574E-2	6.757E-2
Average-3σ (Bias1)	---	1.705E-3	8.457E-4	2.446E-3	9.535E-3	6.975E-3	4.863E-3	3.881E-3	4.324E-3	4.442E-3	1.280E-2
Average (Bias2)	---	8.217E-3	8.000E-3	1.589E-2	2.120E-2	2.284E-2	2.292E-2	2.371E-2	2.530E-2	2.560E-2	4.423E-2
σ (Bias2)	---	1.719E-3	1.668E-3	4.759E-3	5.074E-3	5.431E-3	5.974E-3	7.346E-3	8.547E-3	8.854E-3	1.216E-2
Average+3σ (Bias2)	---	1.337E-2	1.300E-2	3.017E-2	3.642E-2	3.913E-2	4.084E-2	4.574E-2	5.094E-2	5.216E-2	8.072E-2
Average-3σ (Bias2)	---	3.060E-3	2.997E-3	1.613E-3	5.976E-3	6.545E-3	5.000E-3	1.669E-3	-3.465E-4	-9.656E-4	7.738E-3

6. Iceo

Ta=25°C; Vce = 20V; If = 0; Ib = 0

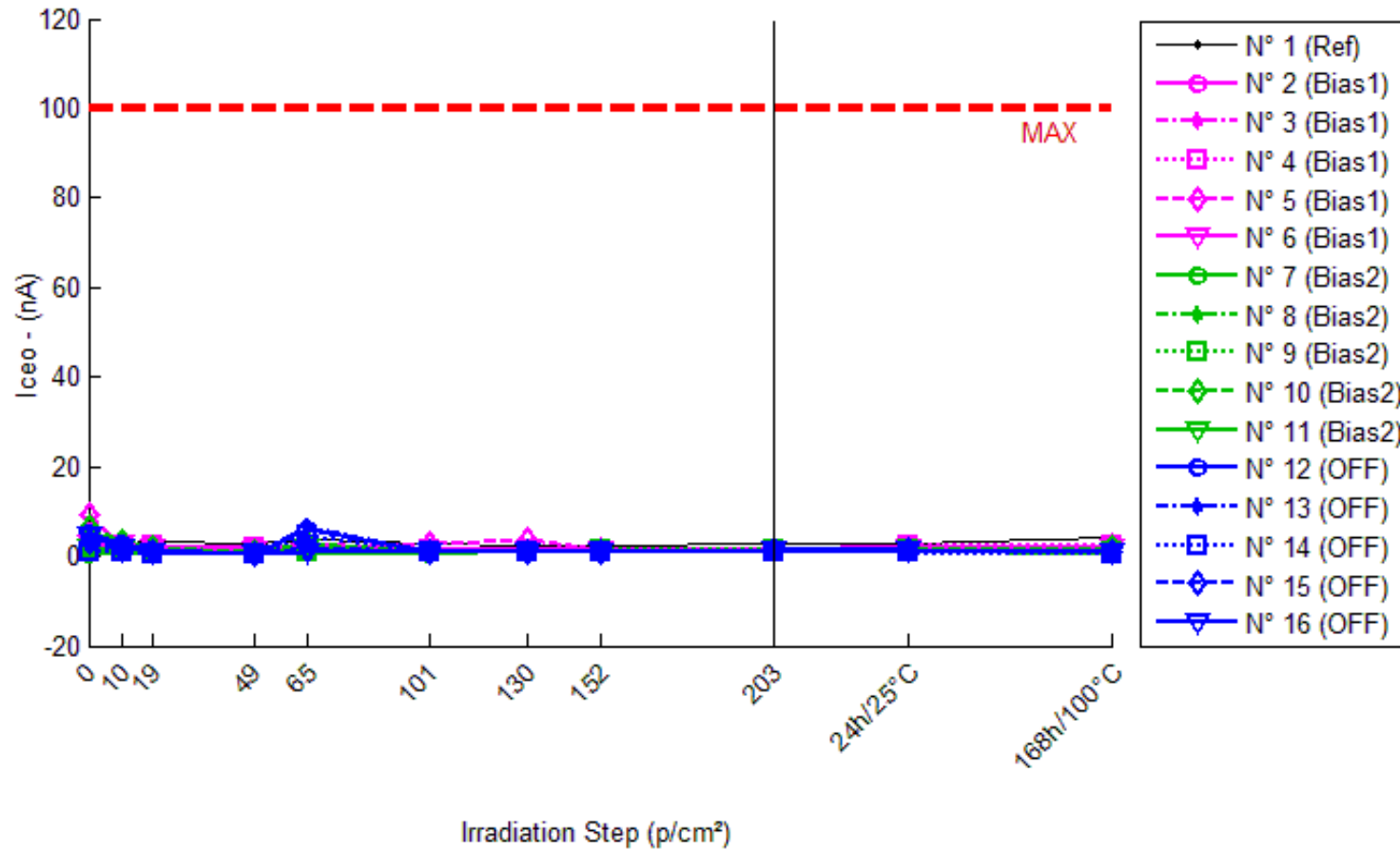

Iceo . (nA)

Max = 100.0

	0krad(Si)	10krad(Si)	19krad(Si)	49krad(Si)	65krad(Si)	101krad(Si)	130krad(Si)	152krad(Si)	203krad(Si)	24h/25°C	168h/100°C
N° 1 (Ref)	4.147	2.736	3.478	2.765	3.714	2.696	2.529	2.389	2.736	2.942	4.389
N° 2 (Bias1)	2.674	1.920	2.090	1.682	513.358	1.368	1.484	1.120	1.252	2.314	2.036
N° 3 (Bias1)	2.829	1.665	1.852	1.394	543.999	1.633	1.354	1.099	1.149	1.748	2.240
N° 4 (Bias1)	2.684	1.935	2.139	1.719	0.789	1.433	1.371	1.265	1.512	2.153	2.158
N° 5 (Bias1)	9.454	2.074	1.884	1.380	539.080	49.573	3.644	1.219	1.406	1.828	2.130
N° 6 (Bias1)	2.926	2.582	2.052	1.282	1.683	1.173	1.191	1.190	1.537	1.764	2.015
N° 7 (Bias2)	0.648	0.830	0.540	0.575	284.955	16.513	1.411	1.087	1.331	1.473	0.618
N° 8 (Bias2)	0.644	0.842	0.554	0.579	0.754	0.859	1.000	1.052	1.306	1.317	0.733
N° 9 (Bias2)	0.830	0.936	0.643	0.615	0.805	0.926	1.178	1.238	1.624	1.582	1.084
N° 10 (Bias2)	6.631	3.386	1.980	0.767	2.997	0.872	1.025	1.047	1.327	1.370	1.995
N° 11 (Bias2)	1.836	1.215	0.848	0.627	2.015	0.904	0.991	1.093	1.420	1.322	0.917
N° 12 (OFF1)	5.014	2.876	1.396	0.653	6.051	0.831	0.861	0.950	1.176	1.159	1.139
N° 13 (OFF1)	2.680	1.692	0.969	0.587	6.665	0.751	0.821	0.904	1.103	1.073	0.851
N° 14 (OFF1)	0.791	1.004	0.698	0.570	4.855	0.769	0.792	0.853	1.067	1.017	0.473
N° 15 (OFF1)	3.178	1.587	0.986	0.613	1.935	0.798	1.081	1.055	1.267	1.456	0.812
N° 16 (OFF1)	4.519	1.771	1.029	0.625	0.917	0.836	0.920	0.989	1.226	1.209	0.833

Delta [Icco]

	0krad(Si)	10krad(Si)	19krad(Si)	49krad(Si)	65krad(Si)	101krad(Si)	130krad(Si)	152krad(Si)	203krad(Si)	24h/25°C	168h/100°C
N° 1 (Ref)	---	-1.411E+0	-6.689E-1	-1.382E+0	-4.323E-1	-1.451E+0	-1.618E+0	-1.758E+0	-1.411E+0	-1.204E+0	2.423E-1
N° 2 (Bias1)	---	-7.535E-1	-5.832E-1	-9.917E-1	5.107E+2	-1.305E+0	-1.189E+0	-1.553E+0	-1.422E+0	-3.592E-1	-6.378E-1
N° 3 (Bias1)	---	-1.164E+0	-9.773E-1	-1.435E+0	5.412E+2	-1.196E+0	-1.475E+0	-1.730E+0	-1.680E+0	-1.080E+0	-5.892E-1
N° 4 (Bias1)	---	-7.493E-1	-5.457E-1	-9.653E-1	-1.895E+0	-1.252E+0	-1.313E+0	-1.420E+0	-1.172E+0	-5.312E-1	-5.262E-1
N° 5 (Bias1)	---	-7.380E+0	-7.570E+0	-8.075E+0	5.296E+2	4.012E+1	-5.810E+0	-8.236E+0	-8.048E+0	-7.627E+0	-7.324E+0
N° 6 (Bias1)	---	-3.432E-1	-8.737E-1	-1.644E+0	-1.242E+0	-1.753E+0	-1.735E+0	-1.735E+0	-1.388E+0	-1.162E+0	-9.101E-1
N° 7 (Bias2)	---	1.821E-1	-1.080E-1	-7.349E-2	2.843E+2	1.587E+1	7.627E-1	4.388E-1	6.827E-1	8.253E-1	-2.996E-2
N° 8 (Bias2)	---	1.981E-1	-9.016E-2	-6.462E-2	1.101E-1	2.151E-1	3.560E-1	4.084E-1	6.623E-1	6.731E-1	8.864E-2
N° 9 (Bias2)	---	1.059E-1	-1.878E-1	-2.153E-1	-2.596E-2	9.533E-2	3.479E-1	4.079E-1	7.940E-1	7.517E-1	2.531E-1
N° 10 (Bias2)	---	-3.245E+0	-4.651E+0	-5.864E+0	-3.633E+0	-5.758E+0	-5.606E+0	-5.584E+0	-5.304E+0	-5.260E+0	-4.636E+0
N° 11 (Bias2)	---	-6.212E-1	-9.878E-1	-1.209E+0	1.785E-1	-9.324E-1	-8.451E-1	-7.428E-1	-4.159E-1	-5.140E-1	-9.191E-1
N° 12 (OFF1)	---	-2.138E+0	-3.618E+0	-4.360E+0	1.037E+0	-4.182E+0	-4.152E+0	-4.064E+0	-3.837E+0	-3.854E+0	-3.875E+0
N° 13 (OFF1)	---	-9.874E-1	-1.710E+0	-2.092E+0	3.985E+0	-1.929E+0	-1.859E+0	-1.775E+0	-1.577E+0	-1.607E+0	-1.828E+0
N° 14 (OFF1)	---	2.133E-1	-9.295E-2	-2.209E-1	4.064E+0	-2.186E-2	1.036E-3	6.178E-2	2.761E-1	2.263E-1	-3.182E-1
N° 15 (OFF1)	---	-1.591E+0	-2.192E+0	-2.565E+0	-1.243E+0	-2.380E+0	-2.097E+0	-2.123E+0	-1.911E+0	-1.722E+0	-2.367E+0
N° 16 (OFF1)	---	-2.748E+0	-3.490E+0	-3.894E+0	-3.602E+0	-3.683E+0	-3.599E+0	-3.530E+0	-3.293E+0	-3.310E+0	-3.686E+0
Average (OFF1)	---	-2.078E+0	-2.110E+0	-2.622E+0	3.157E+2	6.923E+0	-2.304E+0	-2.935E+0	-2.742E+0	-2.152E+0	-1.997E+0
σ (OFF1)	---	2.978E+0	3.058E+0	3.062E+0	2.898E+2	1.856E+1	1.970E+0	2.966E+0	2.972E+0	3.080E+0	2.981E+0
Average+3σ (OFF1)	---	6.857E+0	7.063E+0	6.563E+0	1.185E+3	6.260E+1	3.606E+0	5.964E+0	6.173E+0	7.088E+0	6.946E+0
Average-3σ (OFF1)	---	-1.101E+1	-1.128E+1	-1.181E+1	-5.537E+2	-4.875E+1	-8.215E+0	-1.183E+1	-1.166E+1	-1.139E+1	-1.094E+1
Average (Bias1)	---	-6.760E-1	-1.205E+0	-1.485E+0	5.619E+1	1.897E+0	-9.969E-1	-1.014E+0	-7.161E-1	-7.048E-1	-1.049E+0
σ (Bias1)	---	1.476E+0	1.962E+0	2.493E+0	1.275E+2	8.182E+0	2.646E+0	2.603E+0	2.611E+0	2.605E+0	2.056E+0
Average+3σ (Bias1)	---	3.752E+0	4.682E+0	5.995E+0	4.388E+2	2.644E+1	6.941E+0	6.796E+0	7.117E+0	7.111E+0	5.120E+0
Average-3σ (Bias1)	---	-5.104E+0	-7.091E+0	-8.966E+0	-3.264E+2	-2.265E+1	-8.934E+0	-8.825E+0	-8.550E+0	-8.521E+0	-7.217E+0
Average (Bias2)	---	-1.450E+0	-2.221E+0	-2.626E+0	8.483E-1	-2.439E+0	-2.341E+0	-2.286E+0	-2.068E+0	-2.053E+0	-2.415E+0
σ (Bias2)	---	1.136E+0	1.445E+0	1.635E+0	3.331E+0	1.635E+0	1.631E+0	1.621E+0	1.612E+0	1.607E+0	1.457E+0
Average+3σ (Bias2)	---	1.957E+0	2.114E+0	2.278E+0	1.084E+1	2.466E+0	2.552E+0	2.576E+0	2.767E+0	2.768E+0	1.956E+0
Average-3σ (Bias2)	---	-4.857E+0	-6.555E+0	-7.530E+0	-9.146E+0	-7.344E+0	-7.234E+0	-7.149E+0	-6.904E+0	-6.874E+0	-6.785E+0

7. Ic(on)

Ta=25°C; Vce = 5V; If = 1 mA; Ib = 0

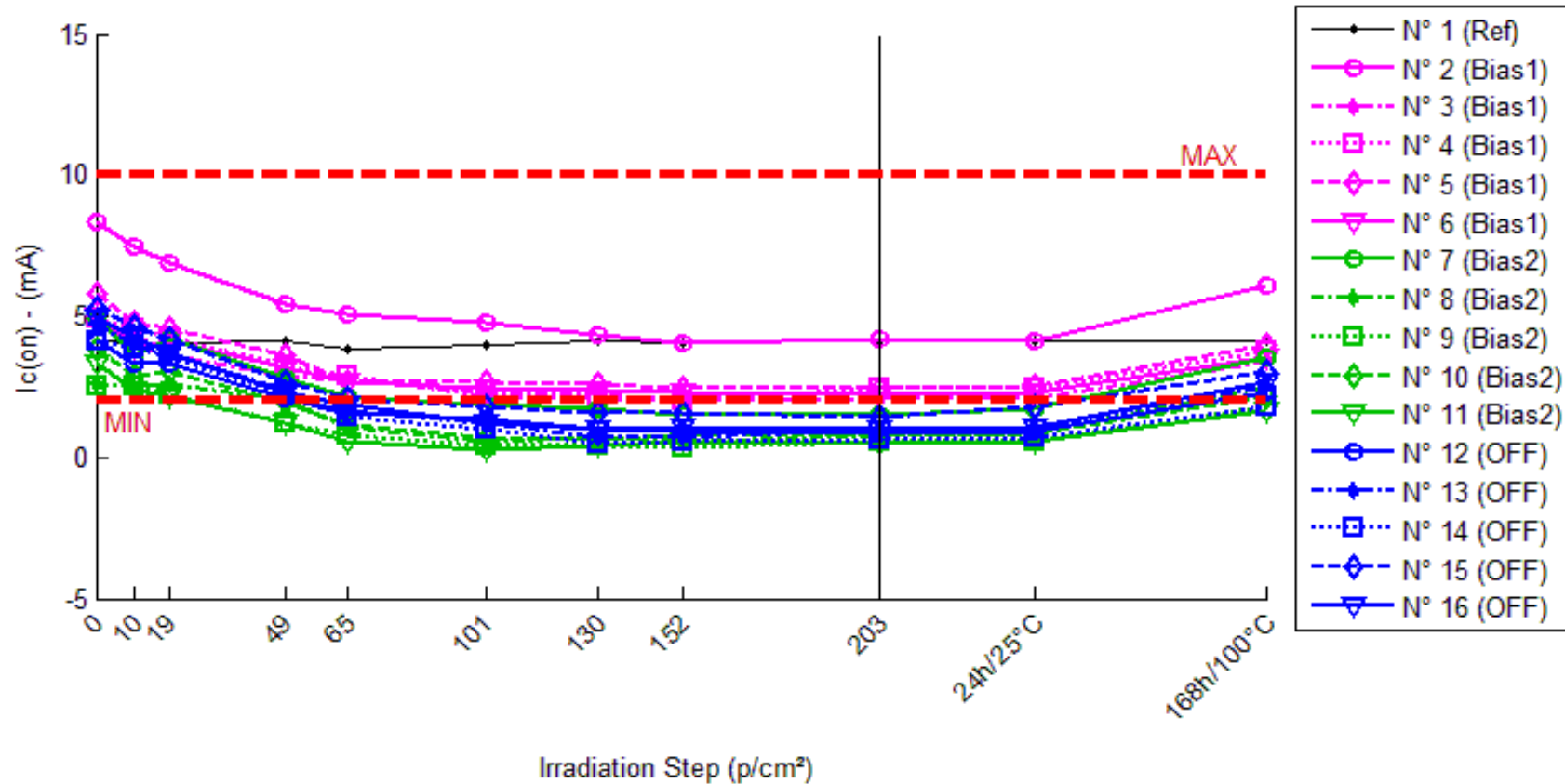

Ic(on) . (mA)

Min = 2.0 Max = 10.0

	0krad(Si)	10krad(Si)	19krad(Si)	49krad(Si)	65krad(Si)	101krad(Si)	130krad(Si)	152krad(Si)	203krad(Si)	24h/25°C	168h/100°C
N° 1 (Ref)	4.109	4.032	4.081	4.104	3.838	3.966	4.123	4.038	4.148	4.130	4.145
N° 2 (Bias1)	8.361	7.443	6.892	5.417	5.048	4.772	4.330	4.070	4.177	4.101	6.118
N° 3 (Bias1)	4.708	4.048	3.646	2.897	2.731	2.277	2.267	2.019	2.081	2.122	3.386
N° 4 (Bias1)	4.940	4.553	4.268	3.238	2.862	2.166	2.076	2.016	2.429	2.445	3.728
N° 5 (Bias1)	5.784	4.774	4.566	3.603	2.702	2.695	2.624	2.483	2.483	2.520	3.987
N° 6 (Bias1)	4.970	3.898	4.115	3.178	2.691	2.430	2.378	2.311	2.259	2.302	3.556
N° 7 (Bias2)	4.902	3.598	4.207	2.806	2.133	1.845	1.739	1.498	1.528	1.709	3.580
N° 8 (Bias2)	2.628	2.528	2.620	1.990	1.080	0.594	0.676	0.532	0.772	0.852	2.548
N° 9 (Bias2)	2.555	2.538	2.210	1.225	0.796	0.441	0.440	0.379	0.541	0.593	1.774
N° 10 (Bias2)	3.816	2.883	3.060	1.930	1.146	0.727	0.621	0.755	0.807	0.867	2.195
N° 11 (Bias2)	3.304	2.409	2.168	1.198	0.587	0.288	0.382	0.545	0.477	0.529	1.641
N° 12 (OFF1)	4.155	3.361	3.324	2.115	1.600	1.390	0.966	0.902	0.839	0.919	2.338
N° 13 (OFF1)	4.681	3.952	3.692	2.393	1.629	1.217	0.711	0.702	0.967	1.063	2.540
N° 14 (OFF1)	4.156	3.914	3.524	2.201	1.433	0.989	0.508	0.597	0.623	0.676	1.788
N° 15 (OFF1)	5.319	4.633	4.174	2.700	2.107	1.792	1.609	1.573	1.462	1.794	3.006
N° 16 (OFF1)	4.934	4.284	3.722	2.300	1.853	1.193	1.013	1.101	0.974	1.084	2.667

Delta [Ic(on)]

	0krad(Si)	10krad(Si)	19krad(Si)	49krad(Si)	65krad(Si)	101krad(Si)	130krad(Si)	152krad(Si)	203krad(Si)	24h/25°C	168h/100°C
N° 1 (Ref)	---	-7.710E-2	-2.819E-2	-4.656E-3	-2.711E-1	-1.430E-1	1.407E-2	-7.113E-2	3.888E-2	2.053E-2	3.625E-2
N° 2 (Bias1)	---	-9.182E-1	-1.469E+0	-2.943E+0	-3.313E+0	-3.589E+0	-4.031E+0	-4.291E+0	-4.184E+0	-4.260E+0	-2.243E+0
N° 3 (Bias1)	---	-6.596E-1	-1.061E+0	-1.811E+0	-1.976E+0	-2.431E+0	-2.441E+0	-2.689E+0	-2.627E+0	-2.586E+0	-1.322E+0
N° 4 (Bias1)	---	-3.869E-1	-6.721E-1	-1.702E+0	-2.078E+0	-2.774E+0	-2.864E+0	-2.924E+0	-2.510E+0	-2.495E+0	-1.212E+0
N° 5 (Bias1)	---	-1.009E+0	-1.218E+0	-2.181E+0	-3.082E+0	-3.089E+0	-3.160E+0	-3.301E+0	-3.301E+0	-3.264E+0	-1.797E+0
N° 6 (Bias1)	---	-1.072E+0	-8.543E-1	-1.792E+0	-2.279E+0	-2.540E+0	-2.591E+0	-2.659E+0	-2.711E+0	-2.668E+0	-1.414E+0
N° 7 (Bias2)	---	-1.305E+0	-6.957E-1	-2.096E+0	-2.770E+0	-3.057E+0	-3.163E+0	-3.405E+0	-3.374E+0	-3.193E+0	-1.323E+0
N° 8 (Bias2)	---	-1.002E-1	-8.290E-3	-6.375E-1	-1.548E+0	-2.034E+0	-1.952E+0	-2.096E+0	-1.856E+0	-1.776E+0	-8.033E-2
N° 9 (Bias2)	---	-1.701E-2	-3.458E-1	-1.331E+0	-1.760E+0	-2.114E+0	-2.115E+0	-2.177E+0	-2.015E+0	-1.962E+0	-7.817E-1
N° 10 (Bias2)	---	-9.330E-1	-7.565E-1	-1.887E+0	-2.670E+0	-3.089E+0	-3.195E+0	-3.061E+0	-3.010E+0	-2.949E+0	-1.622E+0
N° 11 (Bias2)	---	-8.950E-1	-1.136E+0	-2.105E+0	-2.717E+0	-3.016E+0	-2.922E+0	-2.759E+0	-2.827E+0	-2.774E+0	-1.663E+0
N° 12 (OFF1)	---	-7.946E-1	-8.318E-1	-2.041E+0	-2.555E+0	-2.765E+0	-3.189E+0	-3.254E+0	-3.316E+0	-3.236E+0	-1.818E+0
N° 13 (OFF1)	---	-7.284E-1	-9.888E-1	-2.287E+0	-3.052E+0	-3.463E+0	-3.969E+0	-3.979E+0	-3.713E+0	-3.618E+0	-2.140E+0
N° 14 (OFF1)	---	-2.419E-1	-6.320E-1	-1.954E+0	-2.723E+0	-3.167E+0	-3.648E+0	-3.559E+0	-3.533E+0	-3.479E+0	-2.367E+0
N° 15 (OFF1)	---	-6.855E-1	-1.145E+0	-2.618E+0	-3.212E+0	-3.526E+0	-3.709E+0	-3.746E+0	-3.857E+0	-3.524E+0	-2.313E+0
N° 16 (OFF1)	---	-6.501E-1	-1.212E+0	-2.635E+0	-3.082E+0	-3.741E+0	-3.921E+0	-3.833E+0	-3.960E+0	-3.850E+0	-2.267E+0
Average (OFF1)	---	-8.092E-1	-1.055E+0	-2.086E+0	-2.546E+0	-2.884E+0	-3.017E+0	-3.173E+0	-3.067E+0	-3.055E+0	-1.597E+0
σ (OFF1)	---	2.835E-1	3.101E-1	5.133E-1	6.103E-1	4.676E-1	6.296E-1	6.759E-1	6.951E-1	7.385E-1	4.226E-1
Average+3σ (OFF1)	---	4.146E-2	-1.245E-1	-5.459E-1	-7.145E-1	-1.482E+0	-1.129E+0	-1.145E+0	-9.812E-1	-8.392E-1	-3.297E-1
Average-3σ (OFF1)	---	-1.660E+0	-1.985E+0	-3.626E+0	-4.377E+0	-4.287E+0	-4.906E+0	-5.200E+0	-5.152E+0	-5.270E+0	-2.865E+0
Average (Bias1)	---	-6.500E-1	-5.884E-1	-1.611E+0	-2.293E+0	-2.662E+0	-2.669E+0	-2.699E+0	-2.616E+0	-2.531E+0	-1.094E+0
σ (Bias1)	---	5.639E-1	4.286E-1	6.289E-1	5.893E-1	5.383E-1	5.927E-1	5.632E-1	6.543E-1	6.258E-1	6.669E-1
Average+3σ (Bias1)	---	1.042E+0	6.974E-1	2.755E-1	-5.248E-1	-1.047E+0	-8.912E-1	-1.010E+0	-6.533E-1	-6.537E-1	9.069E-1
Average-3σ (Bias1)	---	-2.342E+0	-1.874E+0	-3.498E+0	-4.061E+0	-4.277E+0	-4.448E+0	-4.389E+0	-4.579E+0	-4.408E+0	-3.094E+0
Average (Bias2)	---	-6.201E-1	-9.619E-1	-2.307E+0	-2.925E+0	-3.332E+0	-3.688E+0	-3.674E+0	-3.676E+0	-3.542E+0	-2.181E+0
σ (Bias2)	---	2.182E-1	2.359E-1	3.162E-1	2.743E-1	3.777E-1	3.100E-1	2.799E-1	2.574E-1	2.227E-1	2.197E-1
Average+3σ (Bias2)	---	3.446E-2	-2.542E-1	-1.358E+0	-2.102E+0	-2.199E+0	-2.757E+0	-2.834E+0	-2.904E+0	-2.873E+0	-1.522E+0
Average-3σ (Bias2)	---	-1.275E+0	-1.670E+0	-3.256E+0	-3.748E+0	-4.466E+0	-4.618E+0	-4.514E+0	-4.448E+0	-4.210E+0	-2.840E+0

8. TR1

Ta=25°C; Vcc = 10V; If = 5 mA; RL = 100 Ohms; Ib = 0

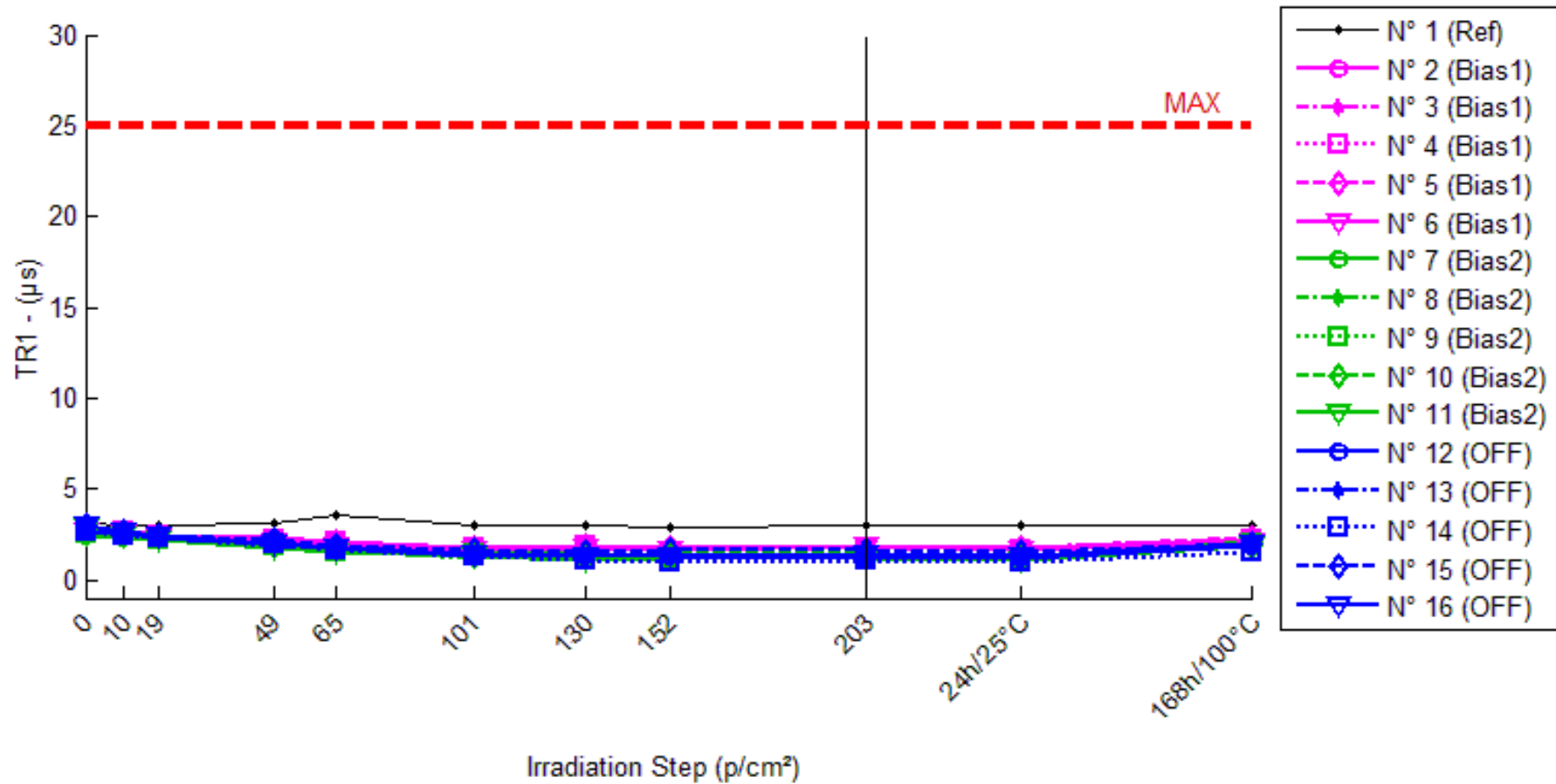

TR1 . (µs)

Max = 25.0

	0krad(Si)	10krad(Si)	19krad(Si)	49krad(Si)	65krad(Si)	101krad(Si)	130krad(Si)	152krad(Si)	203krad(Si)	24h/25°C	168h/100°C
N° 1 (Ref)	3.08	2.96	3.00	3.12	3.52	2.96	3.00	2.86	3.04	3.04	3.00
N° 2 (Bias1)	2.86	2.80	2.46	2.32	2.08	1.72	1.76	1.72	1.76	1.76	2.20
N° 3 (Bias1)	2.76	2.52	2.36	2.20	1.96	1.64	1.72	1.64	1.66	1.64	2.20
N° 4 (Bias1)	2.88	2.64	2.48	2.24	2.08	1.72	1.86	1.58	1.80	1.68	2.18
N° 5 (Bias1)	3.00	2.72	2.48	2.24	2.12	1.80	1.82	1.72	1.72	1.72	2.36
N° 6 (Bias1)	2.72	2.52	2.38	2.10	1.92	1.66	1.72	1.60	1.82	1.60	2.12
N° 7 (Bias2)	2.44	2.32	2.20	1.84	1.64	1.40	1.46	1.36	1.44	1.32	2.04
N° 8 (Bias2)	2.32	2.40	2.28	1.92	1.64	1.24	1.30	1.20	1.36	1.22	2.12
N° 9 (Bias2)	2.60	2.44	2.20	1.88	1.58	1.40	1.24	1.16	1.24	1.22	2.04
N° 10 (Bias2)	2.80	2.52	2.36	2.08	1.72	1.32	1.24	1.40	1.40	1.28	1.92
N° 11 (Bias2)	2.84	2.42	2.16	1.76	1.52	1.32	1.12	1.16	1.20	1.08	1.86
N° 12 (OFF1)	2.72	2.50	2.28	1.96	1.72	1.32	1.32	1.28	1.24	1.20	1.92
N° 13 (OFF1)	2.72	2.52	2.28	1.92	1.72	1.32	1.36	1.28	1.32	1.22	1.88
N° 14 (OFF1)	2.64	2.44	2.28	1.94	1.70	1.28	1.08	1.02	1.04	0.94	1.52
N° 15 (OFF1)	2.96	2.64	2.46	2.18	1.88	1.60	1.54	1.60	1.68	1.52	1.96
N° 16 (OFF1)	3.00	2.64	2.44	2.04	1.72	1.44	1.36	1.34	1.48	1.26	1.96

Delta [TR1]

	0krad(Si)	10krad(Si)	19krad(Si)	49krad(Si)	65krad(Si)	101krad(Si)	130krad(Si)	152krad(Si)	203krad(Si)	24h/25°C	168h/100°C
N° 1 (Ref)	---	-1.200E-1	-8.000E-2	4.000E-2	4.400E-1	-1.200E-1	-8.000E-2	-2.200E-1	-4.000E-2	-4.000E-2	-8.000E-2
N° 2 (Bias1)	---	-6.000E-2	-4.000E-1	-5.400E-1	-7.800E-1	-1.140E+0	-1.100E+0	-1.140E+0	-1.100E+0	-1.100E+0	-6.600E-1
N° 3 (Bias1)	---	-2.400E-1	-4.000E-1	-5.600E-1	-8.000E-1	-1.120E+0	-1.040E+0	-1.120E+0	-1.100E+0	-1.120E+0	-5.600E-1
N° 4 (Bias1)	---	-2.400E-1	-4.000E-1	-6.400E-1	-8.000E-1	-1.160E+0	-1.020E+0	-1.300E+0	-1.080E+0	-1.200E+0	-7.000E-1
N° 5 (Bias1)	---	-2.800E-1	-5.200E-1	-7.600E-1	-8.800E-1	-1.200E+0	-1.180E+0	-1.280E+0	-1.280E+0	-1.280E+0	-6.400E-1
N° 6 (Bias1)	---	-2.000E-1	-3.400E-1	-6.200E-1	-8.000E-1	-1.060E+0	-1.000E+0	-1.120E+0	-9.000E-1	-1.120E+0	-6.000E-1
N° 7 (Bias2)	---	-1.200E-1	-2.400E-1	-6.000E-1	-8.000E-1	-1.040E+0	-9.800E-1	-1.080E+0	-1.000E+0	-1.120E+0	-4.000E-1
N° 8 (Bias2)	---	8.000E-2	-4.000E-2	-4.000E-1	-6.800E-1	-1.080E+0	-1.020E+0	-1.120E+0	-9.600E-1	-1.100E+0	-2.000E-1
N° 9 (Bias2)	---	-1.600E-1	-4.000E-1	-7.200E-1	-1.020E+0	-1.200E+0	-1.360E+0	-1.440E+0	-1.360E+0	-1.380E+0	-5.600E-1
N° 10 (Bias2)	---	-2.800E-1	-4.400E-1	-7.200E-1	-1.080E+0	-1.480E+0	-1.560E+0	-1.400E+0	-1.400E+0	-1.520E+0	-8.800E-1
N° 11 (Bias2)	---	-4.200E-1	-6.800E-1	-1.080E+0	-1.320E+0	-1.520E+0	-1.720E+0	-1.680E+0	-1.640E+0	-1.760E+0	-9.800E-1
N° 12 (OFF1)	---	-2.200E-1	-4.400E-1	-7.600E-1	-1.000E+0	-1.400E+0	-1.400E+0	-1.440E+0	-1.480E+0	-1.520E+0	-8.000E-1
N° 13 (OFF1)	---	-2.000E-1	-4.400E-1	-8.000E-1	-1.000E+0	-1.400E+0	-1.360E+0	-1.440E+0	-1.400E+0	-1.500E+0	-8.400E-1
N° 14 (OFF1)	---	-2.000E-1	-3.600E-1	-7.000E-1	-9.400E-1	-1.360E+0	-1.560E+0	-1.620E+0	-1.600E+0	-1.700E+0	-1.120E+0
N° 15 (OFF1)	---	-3.200E-1	-5.000E-1	-7.800E-1	-1.080E+0	-1.360E+0	-1.420E+0	-1.360E+0	-1.280E+0	-1.440E+0	-1.000E+0
N° 16 (OFF1)	---	-3.600E-1	-5.600E-1	-9.600E-1	-1.280E+0	-1.560E+0	-1.640E+0	-1.660E+0	-1.520E+0	-1.740E+0	-1.040E+0
Average (OFF1)	---	-2.040E-1	-4.120E-1	-6.240E-1	-8.120E-1	-1.136E+0	-1.068E+0	-1.192E+0	-1.092E+0	-1.164E+0	-6.320E-1
σ (OFF1)	---	8.532E-2	6.573E-2	8.649E-2	3.899E-2	5.177E-2	7.294E-2	9.011E-2	1.346E-1	7.537E-2	5.404E-2
Average+3 σ (OFF1)	---	5.197E-2	-2.148E-1	-3.645E-1	-6.950E-1	-9.807E-1	-8.492E-1	-9.217E-1	-6.882E-1	-9.379E-1	-4.699E-1
Average-3 σ (OFF1)	---	-4.600E-1	-6.092E-1	-8.835E-1	-9.290E-1	-1.291E+0	-1.287E+0	-1.462E+0	-1.496E+0	-1.390E+0	-7.941E-1
Average (Bias1)	---	-1.800E-1	-3.600E-1	-7.040E-1	-9.800E-1	-1.264E+0	-1.328E+0	-1.344E+0	-1.272E+0	-1.376E+0	-6.040E-1
σ (Bias1)	---	1.865E-1	2.383E-1	2.475E-1	2.498E-1	2.238E-1	3.258E-1	2.475E-1	2.876E-1	2.784E-1	3.257E-1
Average+3 σ (Bias1)	---	3.796E-1	3.550E-1	3.864E-2	-2.306E-1	-5.926E-1	-3.507E-1	-6.014E-1	-4.092E-1	-5.409E-1	3.731E-1
Average-3 σ (Bias1)	---	-7.396E-1	-1.075E+0	-1.447E+0	-1.729E+0	-1.935E+0	-2.305E+0	-2.087E+0	-2.135E+0	-2.211E+0	-1.581E+0
Average (Bias2)	---	-2.600E-1	-4.600E-1	-8.000E-1	-1.060E+0	-1.416E+0	-1.476E+0	-1.504E+0	-1.456E+0	-1.580E+0	-9.600E-1
σ (Bias2)	---	7.483E-2	7.483E-2	9.695E-2	1.327E-1	8.295E-2	1.187E-1	1.292E-1	1.220E-1	1.319E-1	1.356E-1
Average+3 σ (Bias2)	---	-3.550E-2	-2.355E-1	-5.091E-1	-6.620E-1	-1.167E+0	-1.120E+0	-1.117E+0	-1.090E+0	-1.184E+0	-5.531E-1
Average-3 σ (Bias2)	---	-4.845E-1	-6.845E-1	-1.091E+0	-1.458E+0	-1.665E+0	-1.832E+0	-1.891E+0	-1.822E+0	-1.976E+0	-1.367E+0

9. TF1

Ta=25°C; Vcc = 10V; If = 5 mA; RL = 100 Ohms; Ib = 0

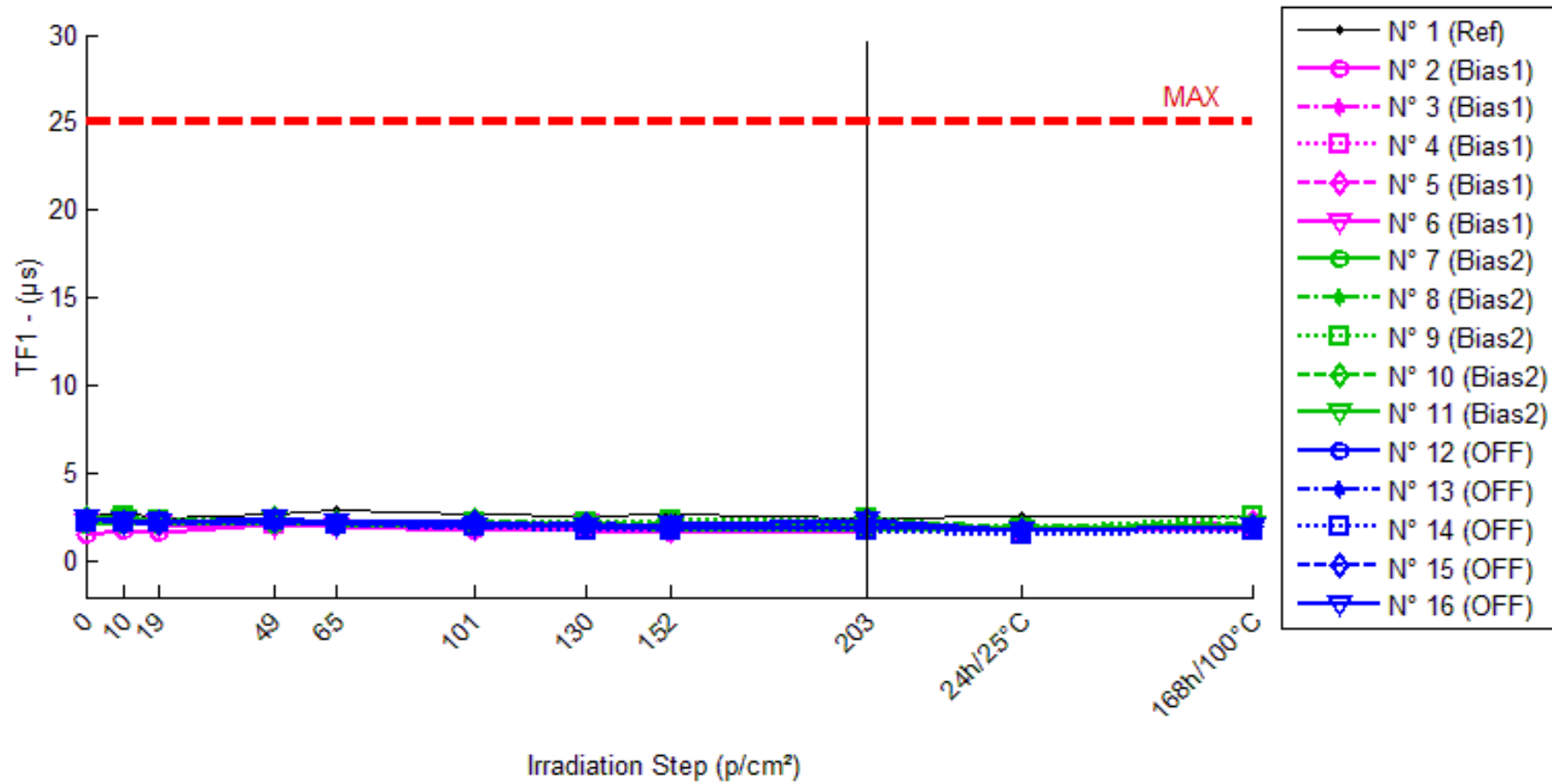

TF1 . (µs)

Max = 25.0

	0krad(Si)	10krad(Si)	19krad(Si)	49krad(Si)	65krad(Si)	101krad(Si)	130krad(Si)	152krad(Si)	203krad(Si)	24h/25°C	168h/100°C
N° 1 (Ref)	2.56	2.82	2.50	2.66	2.94	2.68	2.54	2.68	2.52	2.56	2.56
N° 2 (Bias1)	1.54	1.76	1.68	2.16	1.96	1.76	1.80	1.68	1.76	1.74	1.74
N° 3 (Bias1)	2.30	2.20	2.20	2.20	2.04	1.96	1.88	1.92	1.84	1.76	2.16
N° 4 (Bias1)	2.32	2.26	2.20	2.16	2.16	2.06	1.96	1.92	2.12	1.84	2.04
N° 5 (Bias1)	2.30	2.36	2.16	2.20	2.26	2.04	2.04	1.90	1.88	1.84	2.28
N° 6 (Bias1)	2.24	2.32	2.16	2.04	1.96	1.88	2.22	1.80	2.08	1.88	1.98
N° 7 (Bias2)	2.14	2.12	2.08	2.08	2.08	1.96	2.22	1.76	1.94	1.76	2.00
N° 8 (Bias2)	2.52	2.52	2.40	2.44	2.20	2.10	2.08	2.04	2.36	1.96	2.30
N° 9 (Bias2)	2.38	2.56	2.32	2.36	2.16	2.20	2.20	2.32	2.44	1.92	2.64
N° 10 (Bias2)	2.48	2.40	2.30	2.48	2.26	2.40	2.10	2.12	2.22	1.88	2.06
N° 11 (Bias2)	2.46	2.44	2.24	2.36	2.26	2.06	2.08	2.04	2.12	1.86	2.14
N° 12 (OFF1)	2.40	2.40	2.20	2.34	2.24	2.28	1.96	1.92	2.04	1.80	2.04
N° 13 (OFF1)	2.32	2.24	2.16	2.24	2.16	1.92	2.28	1.92	2.14	1.80	2.00
N° 14 (OFF1)	2.26	2.20	2.20	2.32	2.14	2.00	1.80	1.84	1.80	1.56	1.84
N° 15 (OFF1)	2.36	2.28	2.24	2.36	2.08	2.28	2.16	2.00	2.36	1.84	2.00
N° 16 (OFF1)	2.46	2.34	2.28	2.48	2.20	1.96	2.00	2.12	2.36	1.84	2.06

Delta [TF1]

	0krad(Si)	10krad(Si)	19krad(Si)	49krad(Si)	65krad(Si)	101krad(Si)	130krad(Si)	152krad(Si)	203krad(Si)	24h/25°C	168h/100°C
N° 1 (Ref)	---	2.600E-1	-6.000E-2	1.000E-1	3.800E-1	1.200E-1	-2.000E-2	1.200E-1	-4.000E-2	0.000E+0	0.000E+0
N° 2 (Bias1)	---	2.200E-1	1.400E-1	6.200E-1	4.200E-1	2.200E-1	2.600E-1	1.400E-1	2.200E-1	2.000E-1	2.000E-1
N° 3 (Bias1)	---	-1.000E-1	-1.000E-1	-1.000E-1	-2.600E-1	-3.400E-1	-4.200E-1	-3.800E-1	-4.600E-1	-5.400E-1	-1.400E-1
N° 4 (Bias1)	---	-6.000E-2	-1.200E-1	-1.600E-1	-1.600E-1	-2.600E-1	-3.600E-1	-4.000E-1	-2.000E-1	-4.800E-1	-2.800E-1
N° 5 (Bias1)	---	6.000E-2	-1.400E-1	-1.000E-1	-4.000E-2	-2.600E-1	-2.600E-1	-4.000E-1	-4.200E-1	-4.600E-1	-2.000E-2
N° 6 (Bias1)	---	8.000E-2	-8.000E-2	-2.000E-1	-2.800E-1	-3.600E-1	-2.000E-2	-4.400E-1	-1.600E-1	-3.600E-1	-2.600E-1
N° 7 (Bias2)	---	-2.000E-2	-6.000E-2	-6.000E-2	-6.000E-2	-1.800E-1	8.000E-2	-3.800E-1	-2.000E-1	-3.800E-1	-1.400E-1
N° 8 (Bias2)	---	0.000E+0	-1.200E-1	-8.000E-2	-3.200E-1	-4.200E-1	-4.400E-1	-4.800E-1	-1.600E-1	-5.600E-1	-2.200E-1
N° 9 (Bias2)	---	1.800E-1	-6.000E-2	-2.000E-2	-2.200E-1	-1.800E-1	-1.800E-1	-6.000E-2	6.000E-2	-4.600E-1	2.600E-1
N° 10 (Bias2)	---	-8.000E-2	-1.800E-1	0.000E+0	-2.200E-1	-8.000E-2	-3.800E-1	-3.600E-1	-2.600E-1	-6.000E-1	-4.200E-1
N° 11 (Bias2)	---	-2.000E-2	-2.200E-1	-1.000E-1	-2.000E-1	-4.000E-1	-3.800E-1	-4.200E-1	-3.400E-1	-6.000E-1	-3.200E-1
N° 12 (OFF1)	---	0.000E+0	-2.000E-1	-6.000E-2	-1.600E-1	-1.200E-1	-4.400E-1	-4.800E-1	-3.600E-1	-6.000E-1	-3.600E-1
N° 13 (OFF1)	---	-8.000E-2	-1.600E-1	-8.000E-2	-1.600E-1	-4.000E-1	-4.000E-2	-4.000E-1	-1.800E-1	-5.200E-1	-3.200E-1
N° 14 (OFF1)	---	-6.000E-2	-6.000E-2	6.000E-2	-1.200E-1	-2.600E-1	-4.600E-1	-4.200E-1	-4.600E-1	-7.000E-1	-4.200E-1
N° 15 (OFF1)	---	-8.000E-2	-1.200E-1	0.000E+0	-2.800E-1	-8.000E-2	-2.000E-1	-3.600E-1	0.000E+0	-5.200E-1	-3.600E-1
N° 16 (OFF1)	---	-1.200E-1	-1.800E-1	2.000E-2	-2.600E-1	-5.000E-1	-4.600E-1	-3.400E-1	-1.000E-1	-6.200E-1	-4.000E-1
Average (OFF1)	---	4.000E-2	-6.000E-2	1.200E-2	-6.400E-2	-2.000E-1	-1.600E-1	-2.960E-1	-2.040E-1	-3.280E-1	-1.000E-1
σ (OFF1)	---	1.265E-1	1.140E-1	3.425E-1	2.868E-1	2.392E-1	2.800E-1	2.447E-1	2.711E-1	3.022E-1	1.975E-1
Average+3σ (OFF1)	---	4.195E-1	2.821E-1	1.040E+0	7.965E-1	5.175E-1	6.800E-1	4.381E-1	6.092E-1	5.786E-1	4.925E-1
Average-3σ (OFF1)	---	-3.395E-1	-4.021E-1	-1.016E+0	-9.245E-1	-9.175E-1	-1.000E+0	-1.030E+0	-1.017E+0	-1.235E+0	-6.925E-1
Average (Bias1)	---	1.200E-2	-1.280E-1	-5.200E-2	-2.040E-1	-2.520E-1	-2.600E-1	-3.400E-1	-1.800E-1	-5.200E-1	-1.680E-1
σ (Bias1)	---	9.859E-2	7.155E-2	4.147E-2	9.317E-2	1.501E-1	2.140E-1	1.631E-1	1.503E-1	9.695E-2	2.614E-1
Average+3σ (Bias1)	---	3.078E-1	8.666E-2	7.242E-2	7.550E-2	1.982E-1	3.820E-1	1.493E-1	2.710E-1	-2.291E-1	6.161E-1
Average-3σ (Bias1)	---	-2.838E-1	-3.427E-1	-1.764E-1	-4.835E-1	-7.022E-1	-9.020E-1	-8.293E-1	-6.310E-1	-8.109E-1	-9.521E-1
Average (Bias2)	---	-6.800E-2	-1.440E-1	-1.200E-2	-1.960E-1	-2.720E-1	-3.200E-1	-4.000E-1	-2.200E-1	-5.920E-1	-3.720E-1
σ (Bias2)	---	4.382E-2	5.550E-2	5.762E-2	6.986E-2	1.792E-1	1.913E-1	5.477E-2	1.881E-1	7.563E-2	3.899E-2
Average+3σ (Bias2)	---	6.345E-2	2.249E-2	1.609E-1	1.357E-2	2.657E-1	2.539E-1	-2.357E-1	3.444E-1	-3.651E-1	-2.550E-1
Average-3σ (Bias2)	---	-1.995E-1	-3.105E-1	-1.849E-1	-4.056E-1	-8.097E-1	-8.939E-1	-5.643E-1	-7.844E-1	-8.189E-1	-4.890E-1

10.TR2

Ta=25°C; Vcc = 10V; If = 5 mA; RL = 100 Ohms; Ie = 0

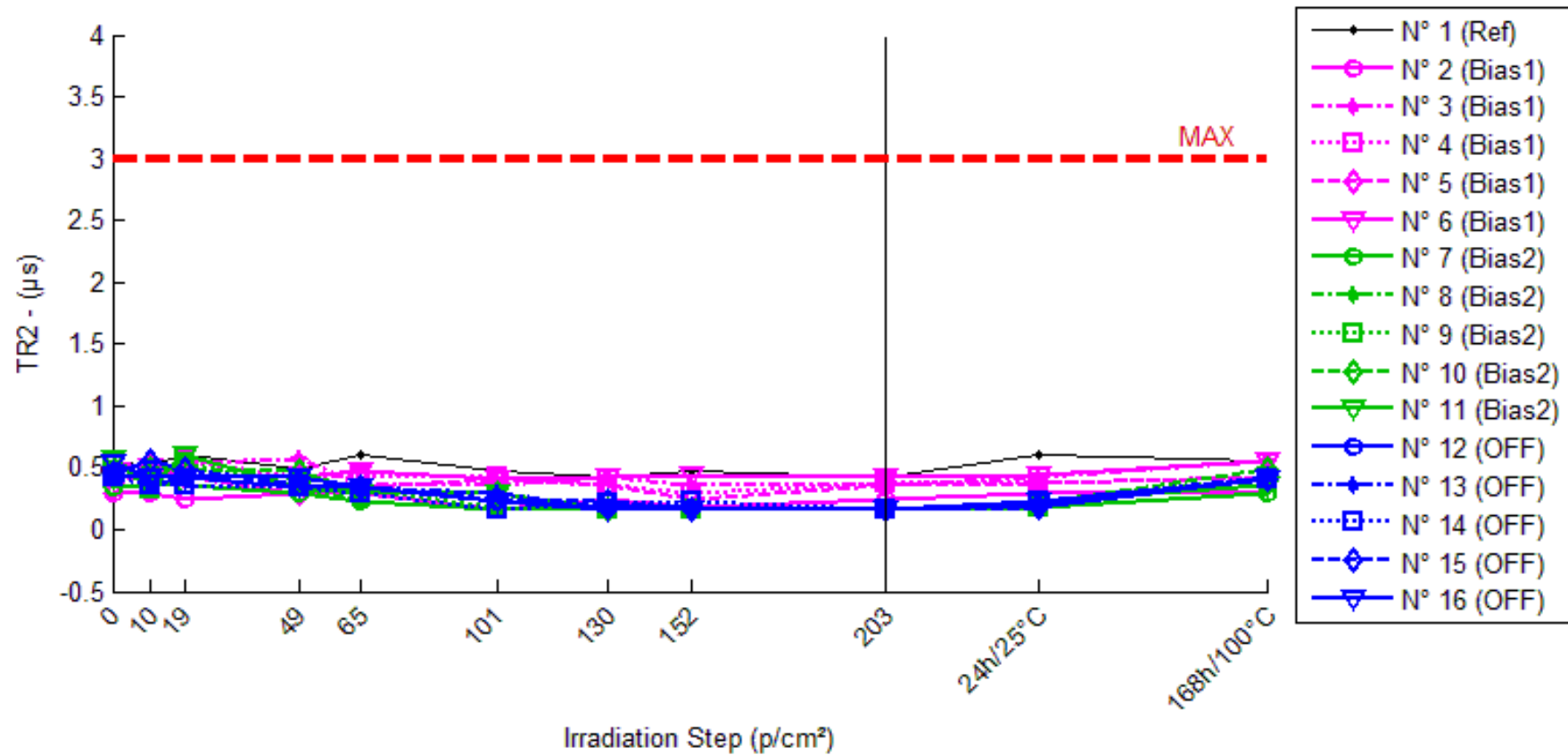

TR2 . (µs)

Max = 3.0

	0krad(Si)	10krad(Si)	19krad(Si)	49krad(Si)	65krad(Si)	101krad(Si)	130krad(Si)	152krad(Si)	203krad(Si)	24h/25°C	168h/100°C
N° 1 (Ref)	0.54	0.53	0.61	0.49	0.61	0.47	0.43	0.48	0.43	0.61	0.55
N° 2 (Bias1)	0.29	0.30	0.24	0.29	0.29	0.17	0.24	0.18	0.24	0.29	0.30
N° 3 (Bias1)	0.42	0.48	0.54	0.57	0.36	0.36	0.42	0.36	0.36	0.43	0.55
N° 4 (Bias1)	0.45	0.46	0.56	0.42	0.42	0.42	0.36	0.30	0.37	0.37	0.43
N° 5 (Bias1)	0.35	0.51	0.42	0.29	0.35	0.41	0.36	0.24	0.36	0.37	0.42
N° 6 (Bias1)	0.54	0.50	0.42	0.42	0.48	0.41	0.42	0.44	0.42	0.44	0.55
N° 7 (Bias2)	0.35	0.36	0.36	0.29	0.23	0.17	0.17	0.16	0.17	0.18	0.30
N° 8 (Bias2)	0.49	0.46	0.42	0.35	0.23	0.17	0.17	0.17	0.17	0.23	0.42
N° 9 (Bias2)	0.54	0.33	0.54	0.35	0.32	0.18	0.17	0.16	0.17	0.18	0.43
N° 10 (Bias2)	0.43	0.49	0.49	0.48	0.30	0.30	0.17	0.17	0.17	0.22	0.49
N° 11 (Bias2)	0.58	0.36	0.61	0.35	0.29	0.29	0.17	0.17	0.17	0.23	0.36
N° 12 (OFF1)	0.42	0.42	0.42	0.35	0.35	0.23	0.18	0.18	0.17	0.19	0.41
N° 13 (OFF1)	0.42	0.36	0.42	0.42	0.35	0.29	0.18	0.17	0.17	0.23	0.43
N° 14 (OFF1)	0.42	0.36	0.36	0.35	0.30	0.17	0.22	0.23	0.17	0.23	0.41
N° 15 (OFF1)	0.46	0.55	0.49	0.36	0.35	0.24	0.23	0.17	0.17	0.18	0.41
N° 16 (OFF1)	0.54	0.43	0.42	0.43	0.35	0.23	0.17	0.17	0.16	0.23	0.41

Delta [TR2]

	0krad(Si)	10krad(Si)	19krad(Si)	49krad(Si)	65krad(Si)	101krad(Si)	130krad(Si)	152krad(Si)	203krad(Si)	24h/25°C	168h/100°C
N° 1 (Ref)	---	-1.000E-2	7.000E-2	-5.000E-2	7.000E-2	-7.000E-2	-1.100E-1	-6.000E-2	-1.100E-1	7.000E-2	1.000E-2
N° 2 (Bias1)	---	1.000E-2	-5.000E-2	0.000E+0	0.000E+0	-1.200E-1	-5.000E-2	-1.100E-1	-5.000E-2	0.000E+0	1.000E-2
N° 3 (Bias1)	---	6.000E-2	1.200E-1	1.500E-1	-6.000E-2	-6.000E-2	0.000E+0	-6.000E-2	-6.000E-2	1.000E-2	1.300E-1
N° 4 (Bias1)	---	1.000E-2	1.100E-1	-3.000E-2	-3.000E-2	-3.000E-2	-9.000E-2	-1.500E-1	-8.000E-2	-8.000E-2	-2.000E-2
N° 5 (Bias1)	---	1.600E-1	7.000E-2	-6.000E-2	0.000E+0	6.000E-2	1.000E-2	-1.100E-1	1.000E-2	2.000E-2	7.000E-2
N° 6 (Bias1)	---	-4.000E-2	-1.200E-1	-1.200E-1	-6.000E-2	-1.300E-1	-1.200E-1	-1.000E-1	-1.200E-1	-1.000E-1	1.000E-2
N° 7 (Bias2)	---	1.000E-2	1.000E-2	-6.000E-2	-1.200E-1	-1.800E-1	-1.800E-1	-1.900E-1	-1.800E-1	-1.700E-1	-5.000E-2
N° 8 (Bias2)	---	-3.000E-2	-7.000E-2	-1.400E-1	-2.600E-1	-3.200E-1	-3.200E-1	-3.200E-1	-3.200E-1	-2.600E-1	-7.000E-2
N° 9 (Bias2)	---	-2.100E-1	0.000E+0	-1.900E-1	-2.200E-1	-3.600E-1	-3.700E-1	-3.800E-1	-3.700E-1	-3.600E-1	-1.100E-1
N° 10 (Bias2)	---	6.000E-2	6.000E-2	5.000E-2	-1.300E-1	-1.300E-1	-2.600E-1	-2.600E-1	-2.600E-1	-2.100E-1	6.000E-2
N° 11 (Bias2)	---	-2.200E-1	3.000E-2	-2.300E-1	-2.900E-1	-2.900E-1	-4.100E-1	-4.100E-1	-4.100E-1	-3.500E-1	-2.200E-1
N° 12 (OFF1)	---	0.000E+0	0.000E+0	-7.000E-2	-7.000E-2	-1.900E-1	-2.400E-1	-2.400E-1	-2.500E-1	-2.300E-1	-1.000E-2
N° 13 (OFF1)	---	-6.000E-2	0.000E+0	0.000E+0	-7.000E-2	-1.300E-1	-2.400E-1	-2.500E-1	-2.500E-1	-1.900E-1	1.000E-2
N° 14 (OFF1)	---	-6.000E-2	-6.000E-2	-7.000E-2	-1.200E-1	-2.500E-1	-2.000E-1	-1.900E-1	-2.500E-1	-1.900E-1	-1.000E-2
N° 15 (OFF1)	---	9.000E-2	3.000E-2	-1.000E-1	-1.100E-1	-2.200E-1	-2.300E-1	-2.900E-1	-2.900E-1	-2.800E-1	-5.000E-2
N° 16 (OFF1)	---	-1.100E-1	-1.200E-1	-1.100E-1	-1.900E-1	-3.100E-1	-3.700E-1	-3.700E-1	-3.800E-1	-3.100E-1	-1.300E-1
Average (OFF1)	---	4.000E-2	2.600E-2	-1.200E-2	-3.000E-2	-5.600E-2	-5.000E-2	-1.060E-1	-6.000E-2	-3.000E-2	4.000E-2
σ (OFF1)	---	7.583E-2	1.060E-1	1.008E-1	3.000E-2	7.701E-2	5.612E-2	3.209E-2	4.743E-2	5.568E-2	6.000E-2
Average+3 σ (OFF1)	---	2.675E-1	3.439E-1	2.905E-1	6.000E-2	1.750E-1	1.184E-1	-9.719E-3	8.230E-2	1.370E-1	2.200E-1
Average-3 σ (OFF1)	---	-1.875E-1	-2.919E-1	-3.145E-1	-1.200E-1	-2.870E-1	-2.184E-1	-2.023E-1	-2.023E-1	-1.970E-1	-1.400E-1
Average (Bias1)	---	-7.800E-2	6.000E-3	-1.140E-1	-2.040E-1	-2.560E-1	-3.080E-1	-3.120E-1	-3.080E-1	-2.700E-1	-7.800E-2
σ (Bias1)	---	1.291E-1	4.827E-2	1.115E-1	7.635E-2	9.711E-2	9.094E-2	8.927E-2	9.094E-2	8.396E-2	1.013E-1
Average+3 σ (Bias1)	---	3.093E-1	1.508E-1	2.205E-1	2.506E-2	3.532E-2	-3.518E-2	-4.418E-2	-3.518E-2	-1.811E-2	2.260E-1
Average-3 σ (Bias1)	---	-4.653E-1	-1.388E-1	-4.485E-1	-4.331E-1	-5.473E-1	-5.808E-1	-5.798E-1	-5.808E-1	-5.219E-1	-3.820E-1
Average (Bias2)	---	-2.800E-2	-3.000E-2	-7.000E-2	-1.120E-1	-2.200E-1	-2.560E-1	-2.680E-1	-2.840E-1	-2.400E-1	-3.800E-2
σ (Bias2)	---	7.662E-2	6.000E-2	4.301E-2	4.919E-2	6.708E-2	6.580E-2	6.723E-2	5.639E-2	5.385E-2	5.586E-2
Average+3 σ (Bias2)	---	2.018E-1	1.500E-1	5.903E-2	3.558E-2	-1.875E-2	-5.859E-2	-6.631E-2	-1.148E-1	-7.845E-2	1.296E-1
Average-3 σ (Bias2)	---	-2.578E-1	-2.100E-1	-1.990E-1	-2.596E-1	-4.212E-1	-4.534E-1	-4.697E-1	-4.532E-1	-4.016E-1	-2.056E-1

11.TF2

Ta=25°C; Vcc = 10V; If = 5 mA; RL = 100 Ohms; Ie = 0

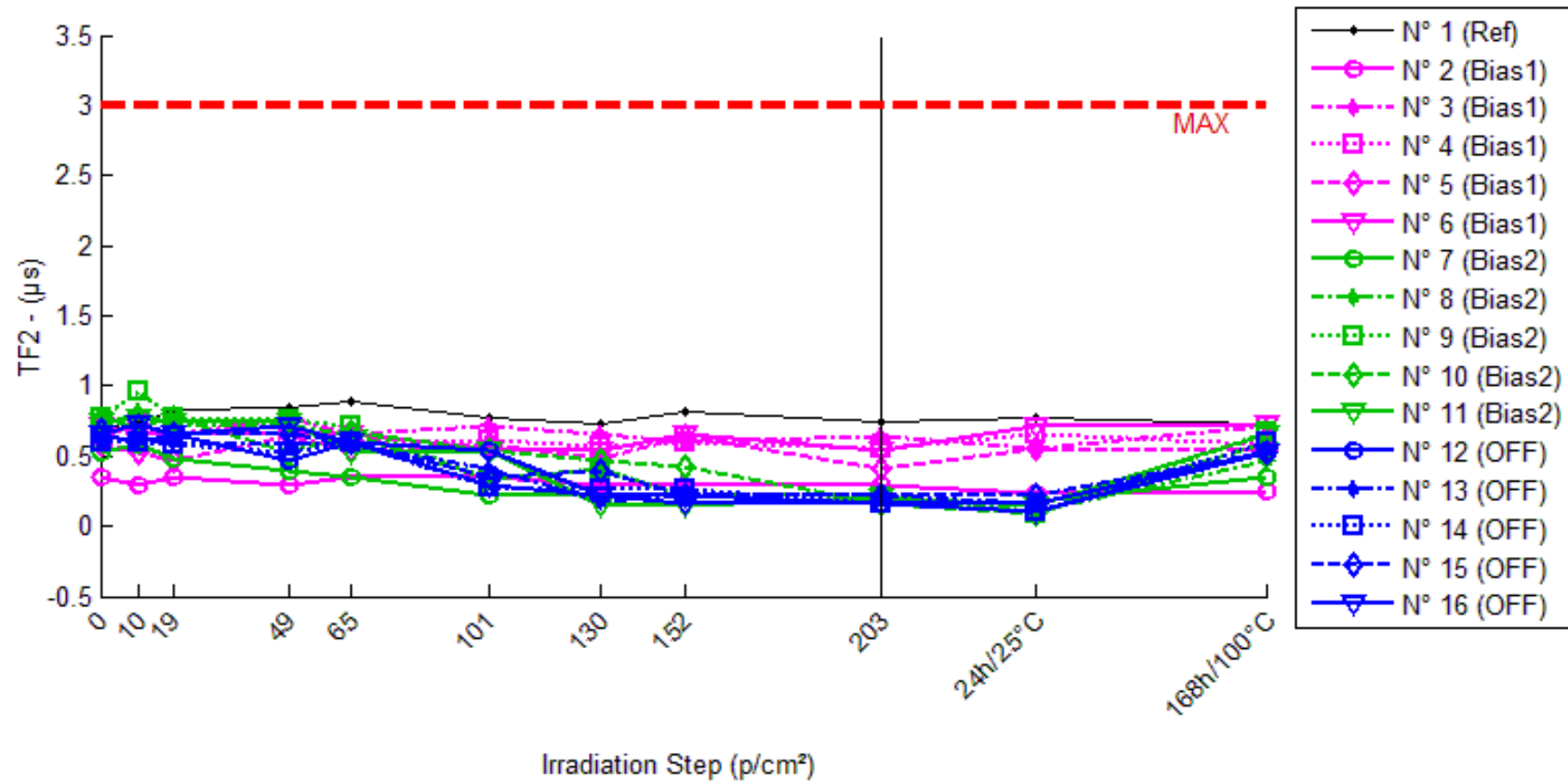

TF2 . (µs)

Max = 3.0

	0krad(Si)	10krad(Si)	19krad(Si)	49krad(Si)	65krad(Si)	101krad(Si)	130krad(Si)	152krad(Si)	203krad(Si)	24h/25°C	168h/100°C
N° 1 (Ref)	0.72	0.73	0.83	0.84	0.89	0.78	0.73	0.82	0.74	0.78	0.73
N° 2 (Bias1)	0.35	0.29	0.35	0.29	0.35	0.35	0.29	0.29	0.29	0.24	0.25
N° 3 (Bias1)	0.70	0.65	0.66	0.78	0.66	0.72	0.65	0.60	0.64	0.55	0.72
N° 4 (Bias1)	0.64	0.73	0.65	0.72	0.60	0.61	0.57	0.60	0.56	0.65	0.59
N° 5 (Bias1)	0.59	0.53	0.47	0.64	0.54	0.59	0.48	0.64	0.41	0.55	0.54
N° 6 (Bias1)	0.72	0.67	0.66	0.65	0.65	0.56	0.54	0.66	0.54	0.72	0.73
N° 7 (Bias2)	0.53	0.59	0.48	0.40	0.35	0.22	0.22	0.22	0.16	0.17	0.35
N° 8 (Bias2)	0.72	0.81	0.72	0.71	0.66	0.34	0.41	0.22	0.22	0.10	0.47
N° 9 (Bias2)	0.77	0.96	0.78	0.76	0.71	0.34	0.41	0.21	0.21	0.09	0.67
N° 10 (Bias2)	0.76	0.71	0.78	0.52	0.67	0.54	0.47	0.42	0.16	0.09	0.60
N° 11 (Bias2)	0.74	0.77	0.75	0.75	0.52	0.54	0.15	0.15	0.21	0.15	0.65
N° 12 (OFF1)	0.65	0.60	0.66	0.47	0.60	0.54	0.22	0.22	0.16	0.16	0.53
N° 13 (OFF1)	0.60	0.61	0.60	0.58	0.59	0.41	0.17	0.22	0.22	0.16	0.54
N° 14 (OFF1)	0.60	0.60	0.58	0.53	0.60	0.28	0.27	0.26	0.16	0.10	0.60
N° 15 (OFF1)	0.69	0.71	0.66	0.65	0.60	0.35	0.40	0.22	0.22	0.22	0.53
N° 16 (OFF1)	0.66	0.73	0.66	0.72	0.60	0.29	0.22	0.16	0.16	0.10	0.53

Delta [TF2]

	0krad(Si)	10krad(Si)	19krad(Si)	49krad(Si)	65krad(Si)	101krad(Si)	130krad(Si)	152krad(Si)	203krad(Si)	24h/25°C	168h/100°C
N° 1 (Ref)	---	1.000E-2	1.100E-1	1.200E-1	1.700E-1	6.000E-2	1.000E-2	1.000E-1	2.000E-2	6.000E-2	1.000E-2
N° 2 (Bias1)	---	-6.000E-2	0.000E+0	-6.000E-2	0.000E+0	0.000E+0	-6.000E-2	-6.000E-2	-6.000E-2	-1.100E-1	-1.000E-1
N° 3 (Bias1)	---	-5.000E-2	-4.000E-2	8.000E-2	-4.000E-2	2.000E-2	-5.000E-2	-1.000E-1	-6.000E-2	-1.500E-1	2.000E-2
N° 4 (Bias1)	---	9.000E-2	1.000E-2	8.000E-2	-4.000E-2	-3.000E-2	-7.000E-2	-4.000E-2	-8.000E-2	1.000E-2	-5.000E-2
N° 5 (Bias1)	---	-6.000E-2	-1.200E-1	5.000E-2	-5.000E-2	0.000E+0	-1.100E-1	5.000E-2	-1.800E-1	-4.000E-2	-5.000E-2
N° 6 (Bias1)	---	-5.000E-2	-6.000E-2	-7.000E-2	-7.000E-2	-1.600E-1	-1.800E-1	-6.000E-2	-1.800E-1	0.000E+0	1.000E-2
N° 7 (Bias2)	---	6.000E-2	-5.000E-2	-1.300E-1	-1.800E-1	-3.100E-1	-3.100E-1	-3.100E-1	-3.700E-1	-3.600E-1	-1.800E-1
N° 8 (Bias2)	---	9.000E-2	0.000E+0	-1.000E-2	-6.000E-2	-3.800E-1	-3.100E-1	-5.000E-1	-5.000E-1	-6.200E-1	-2.500E-1
N° 9 (Bias2)	---	1.900E-1	1.000E-2	-1.000E-2	-6.000E-2	-4.300E-1	-3.600E-1	-5.600E-1	-5.600E-1	-6.800E-1	-1.000E-1
N° 10 (Bias2)	---	-5.000E-2	2.000E-2	-2.400E-1	-9.000E-2	-2.200E-1	-2.900E-1	-3.400E-1	-6.000E-1	-6.700E-1	-1.600E-1
N° 11 (Bias2)	---	3.000E-2	1.000E-2	1.000E-2	-2.200E-1	-2.000E-1	-5.900E-1	-5.900E-1	-5.300E-1	-5.900E-1	-9.000E-2
N° 12 (OFF1)	---	-5.000E-2	1.000E-2	-1.800E-1	-5.000E-2	-1.100E-1	-4.300E-1	-4.300E-1	-4.900E-1	-4.900E-1	-1.200E-1
N° 13 (OFF1)	---	1.000E-2	0.000E+0	-2.000E-2	-1.000E-2	-1.900E-1	-4.300E-1	-3.800E-1	-3.800E-1	-4.400E-1	-6.000E-2
N° 14 (OFF1)	---	0.000E+0	-2.000E-2	-7.000E-2	0.000E+0	-3.200E-1	-3.300E-1	-3.400E-1	-4.400E-1	-5.000E-1	0.000E+0
N° 15 (OFF1)	---	2.000E-2	-3.000E-2	-4.000E-2	-9.000E-2	-3.400E-1	-2.900E-1	-4.700E-1	-4.700E-1	-4.700E-1	-1.600E-1
N° 16 (OFF1)	---	7.000E-2	0.000E+0	6.000E-2	-6.000E-2	-3.700E-1	-4.400E-1	-5.000E-1	-5.000E-1	-5.600E-1	-1.300E-1
Average (OFF1)	---	-2.600E-2	-4.200E-2	1.600E-2	-4.000E-2	-3.400E-2	-9.400E-2	-4.200E-2	-1.120E-1	-5.800E-2	-3.400E-2
σ (OFF1)	---	6.504E-2	5.215E-2	7.503E-2	2.550E-2	7.266E-2	5.320E-2	5.586E-2	6.261E-2	6.979E-2	4.930E-2
Average+3σ (OFF1)	---	1.691E-1	1.145E-1	2.411E-1	3.649E-2	1.840E-1	6.559E-2	1.256E-1	7.583E-2	1.514E-1	1.139E-1
Average-3σ (OFF1)	---	-2.211E-1	-1.985E-1	-2.091E-1	-1.165E-1	-2.520E-1	-2.536E-1	-2.096E-1	-2.998E-1	-2.674E-1	-1.819E-1
Average (Bias1)	---	6.400E-2	-2.000E-3	-7.600E-2	-1.220E-1	-3.080E-1	-3.720E-1	-4.600E-1	-5.120E-1	-5.840E-1	-1.560E-1
σ (Bias1)	---	8.764E-2	2.775E-2	1.071E-1	7.362E-2	9.935E-2	1.246E-1	1.279E-1	8.758E-2	1.305E-1	6.504E-2
Average+3σ (Bias1)	---	3.269E-1	8.125E-2	2.454E-1	9.886E-2	-9.956E-3	1.738E-3	-7.640E-2	-2.493E-1	-1.925E-1	3.912E-2
Average-3σ (Bias1)	---	-1.989E-1	-8.525E-2	-3.974E-1	-3.429E-1	-6.060E-1	-7.457E-1	-8.436E-1	-7.747E-1	-9.755E-1	-3.511E-1
Average (Bias2)	---	1.000E-2	-8.000E-3	-5.000E-2	-4.200E-2	-2.660E-1	-3.840E-1	-4.240E-1	-4.560E-1	-4.920E-1	-9.400E-2
σ (Bias2)	---	4.301E-2	1.643E-2	8.718E-2	3.701E-2	1.110E-1	6.914E-2	6.504E-2	4.827E-2	4.438E-2	6.387E-2
Average+3σ (Bias2)	---	1.390E-1	4.130E-2	2.115E-1	6.904E-2	6.712E-2	-1.766E-1	-2.289E-1	-3.112E-1	-3.588E-1	9.762E-2
Average-3σ (Bias2)	---	-1.190E-1	-5.730E-2	-3.115E-1	-1.530E-1	-5.991E-1	-5.914E-1	-6.191E-1	-6.008E-1	-6.252E-1	-2.856E-1

12.CTR1

Ta=25°C; Vce = 5V; If = 1 mA

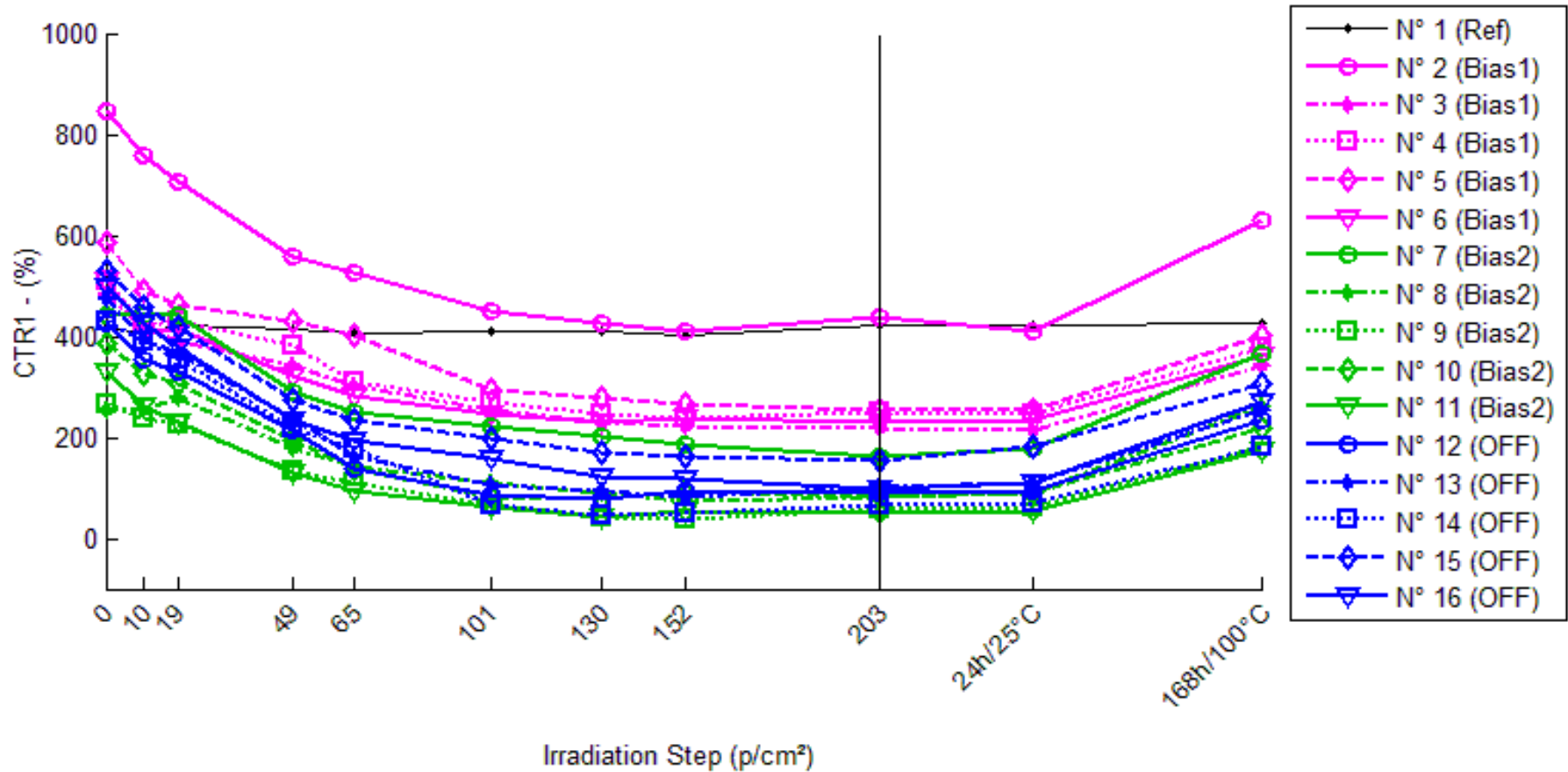

CTR1 . (%)

	0krad(Si)	10krad(Si)	19krad(Si)	49krad(Si)	65krad(Si)	101krad(Si)	130krad(Si)	152krad(Si)	203krad(Si)	24h/25°C	168h/100°C
N° 1 (Ref)	419.00	406.38	421.14	413.27	404.55	408.17	411.13	402.48	421.84	420.16	424.67
N° 2 (Bias1)	846.58	759.82	705.23	558.53	524.81	451.91	427.07	411.36	436.66	408.70	628.37
N° 3 (Bias1)	480.72	417.73	389.61	341.59	301.30	252.59	229.49	222.35	219.08	213.21	342.07
N° 4 (Bias1)	511.33	420.59	430.95	380.53	311.47	270.27	247.45	238.88	248.99	246.61	377.27
N° 5 (Bias1)	586.66	489.79	463.61	431.79	400.72	293.13	276.35	264.25	254.69	254.44	401.97
N° 6 (Bias1)	509.82	410.20	415.58	320.91	280.91	244.56	228.57	237.54	231.03	235.03	360.56
N° 7 (Bias2)	441.13	443.42	442.61	290.90	249.44	220.84	202.58	187.56	161.32	176.27	365.01
N° 8 (Bias2)	252.18	254.54	276.83	179.66	143.82	109.28	88.59	73.17	81.71	88.52	260.61
N° 9 (Bias2)	267.70	236.49	224.93	132.38	108.03	65.23	43.83	36.89	56.57	61.07	181.38
N° 10 (Bias2)	387.48	324.10	304.41	195.73	137.68	81.61	77.38	94.48	84.00	88.02	219.93
N° 11 (Bias2)	329.41	262.08	229.90	130.81	93.66	60.86	41.58	53.72	50.19	54.85	173.19
N° 12 (OFF1)	424.94	354.79	330.47	213.44	138.09	86.99	77.42	93.44	88.14	94.06	235.33
N° 13 (OFF1)	474.98	393.38	367.25	239.20	160.43	106.75	94.21	83.38	100.61	108.75	255.16
N° 14 (OFF1)	429.80	391.13	354.14	219.07	178.65	66.22	47.78	50.17	64.87	69.42	182.03
N° 15 (OFF1)	530.86	459.86	416.21	273.87	235.88	199.87	169.68	163.40	152.67	183.65	304.68
N° 16 (OFF1)	499.99	426.68	377.86	233.57	192.73	157.02	123.19	116.51	99.08	110.33	268.40

1/Delta [CTR1]

	0krad(Si)	10krad(Si)	19krad(Si)	49krad(Si)	65krad(Si)	101krad(Si)	130krad(Si)	152krad(Si)	203krad(Si)	24h/25°C	168h/100°C
N° 1 (Ref)	---	7.414E-5	-1.210E-5	3.309E-5	8.525E-5	6.333E-5	4.569E-5	9.799E-5	-1.603E-5	-6.587E-6	-3.186E-5
N° 2 (Bias1)	---	1.349E-4	2.368E-4	6.092E-4	7.242E-4	1.032E-3	1.160E-3	1.250E-3	1.109E-3	1.266E-3	4.102E-4
N° 3 (Bias1)	---	3.137E-4	4.865E-4	8.473E-4	1.239E-3	1.879E-3	2.277E-3	2.417E-3	2.484E-3	2.610E-3	8.431E-4
N° 4 (Bias1)	---	4.219E-4	3.647E-4	6.722E-4	1.255E-3	1.744E-3	2.085E-3	2.230E-3	2.061E-3	2.099E-3	6.949E-4
N° 5 (Bias1)	---	3.371E-4	4.524E-4	6.114E-4	7.909E-4	1.707E-3	1.914E-3	2.080E-3	2.222E-3	2.226E-3	7.832E-4
N° 6 (Bias1)	---	4.764E-4	4.448E-4	1.155E-3	1.598E-3	2.128E-3	2.413E-3	2.248E-3	2.367E-3	2.293E-3	8.120E-4
N° 7 (Bias2)	---	-1.168E-5	-7.582E-6	1.171E-3	1.742E-3	2.261E-3	2.670E-3	3.065E-3	3.932E-3	3.406E-3	4.727E-4
N° 8 (Bias2)	---	-3.681E-5	-3.531E-4	1.601E-3	2.988E-3	5.185E-3	7.322E-3	9.702E-3	8.272E-3	7.331E-3	-1.282E-4
N° 9 (Bias2)	---	4.930E-4	7.103E-4	3.819E-3	5.521E-3	1.159E-2	1.908E-2	2.337E-2	1.394E-2	1.264E-2	1.778E-3
N° 10 (Bias2)	---	5.047E-4	7.042E-4	2.528E-3	4.683E-3	9.672E-3	1.034E-2	8.004E-3	9.324E-3	8.781E-3	1.966E-3
N° 11 (Bias2)	---	7.800E-4	1.314E-3	4.609E-3	7.641E-3	1.340E-2	2.101E-2	1.558E-2	1.689E-2	1.520E-2	2.738E-3
N° 12 (OFF1)	---	4.653E-4	6.727E-4	2.332E-3	4.888E-3	9.143E-3	1.056E-2	8.349E-3	8.992E-3	8.279E-3	1.896E-3
N° 13 (OFF1)	---	4.367E-4	6.176E-4	2.075E-3	4.128E-3	7.263E-3	8.510E-3	9.889E-3	7.834E-3	7.090E-3	1.814E-3
N° 14 (OFF1)	---	2.300E-4	4.970E-4	2.238E-3	3.271E-3	1.278E-2	1.860E-2	1.761E-2	1.309E-2	1.208E-2	3.167E-3
N° 15 (OFF1)	---	2.909E-4	5.189E-4	1.768E-3	2.356E-3	3.120E-3	4.010E-3	4.236E-3	4.666E-3	3.561E-3	1.398E-3
N° 16 (OFF1)	---	3.436E-4	6.464E-4	2.281E-3	3.188E-3	4.369E-3	6.117E-3	6.583E-3	8.093E-3	7.063E-3	1.726E-3
Average (OFF1)	---	3.368E-4	3.970E-4	7.789E-4	1.121E-3	1.698E-3	1.970E-3	2.045E-3	2.048E-3	2.099E-3	7.087E-4
σ (OFF1)	---	1.304E-4	1.001E-4	2.314E-4	3.627E-4	4.073E-4	4.907E-4	4.604E-4	5.487E-4	5.024E-4	1.758E-4
Average+3σ (OFF1)	---	7.280E-4	6.973E-4	1.473E-3	2.209E-3	2.920E-3	3.442E-3	3.426E-3	3.695E-3	3.606E-3	1.236E-3
Average-3σ (OFF1)	---	-5.444E-5	9.675E-5	8.484E-5	3.349E-5	4.760E-4	4.980E-4	6.639E-4	4.024E-4	5.917E-4	1.813E-4
Average (Bias1)	---	3.458E-4	4.736E-4	2.745E-3	4.515E-3	8.422E-3	1.209E-2	1.194E-2	1.047E-2	9.470E-3	1.365E-3
σ (Bias1)	---	3.569E-4	6.577E-4	1.454E-3	2.282E-3	4.604E-3	7.794E-3	7.797E-3	5.053E-3	4.600E-3	1.167E-3
Average+3σ (Bias1)	---	1.417E-3	2.447E-3	7.109E-3	1.136E-2	2.223E-2	3.547E-2	3.533E-2	2.563E-2	2.327E-2	4.865E-3
Average-3σ (Bias1)	---	-7.249E-4	-1.500E-3	-1.618E-3	-2.332E-3	-5.391E-3	-1.130E-2	-1.145E-2	-4.687E-3	-4.330E-3	-2.134E-3
Average (Bias2)	---	3.533E-4	5.905E-4	2.139E-3	3.566E-3	7.334E-3	9.561E-3	9.332E-3	8.535E-3	7.614E-3	2.000E-3
σ (Bias2)	---	9.836E-5	7.824E-5	2.287E-4	9.693E-4	3.855E-3	5.625E-3	5.081E-3	3.025E-3	3.057E-3	6.790E-4
Average+3σ (Bias2)	---	6.484E-4	8.253E-4	2.825E-3	6.474E-3	1.890E-2	2.643E-2	2.457E-2	1.761E-2	1.678E-2	4.037E-3
Average-3σ (Bias2)	---	5.823E-5	3.558E-4	1.453E-3	6.583E-4	-4.231E-3	-7.313E-3	-5.910E-3	-5.409E-4	-1.555E-3	-3.693E-5

13.CTR2

Ta=25°C; Vce = 5V; If = 2 mA

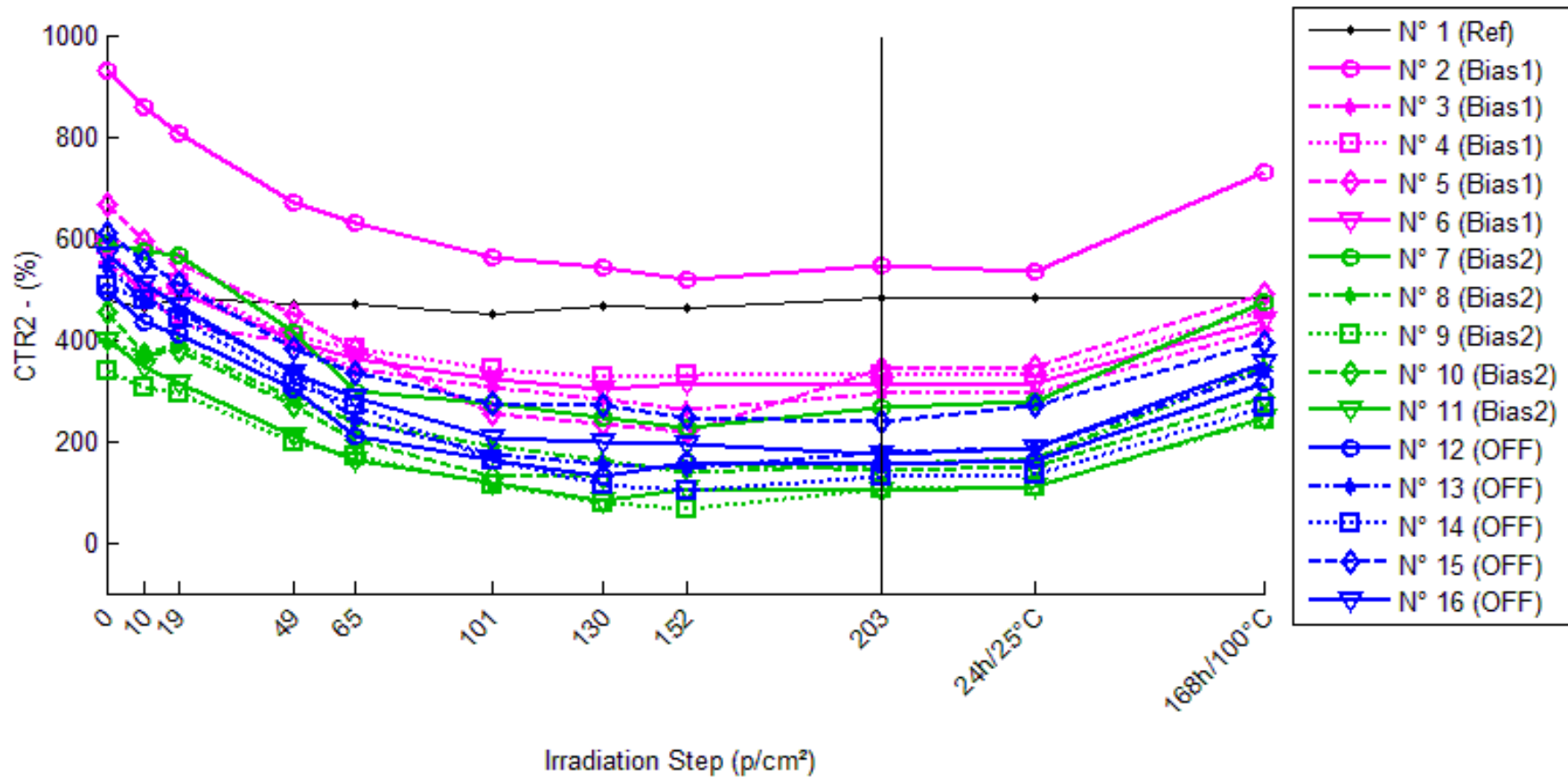

CTR2 . (%)

	0krad(Si)	10krad(Si)	19krad(Si)	49krad(Si)	65krad(Si)	101krad(Si)	130krad(Si)	152krad(Si)	203krad(Si)	24h/25°C	168h/100°C
N° 1 (Ref)	479.12	463.70	480.46	470.35	470.50	451.90	467.70	461.59	482.55	481.65	483.64
N° 2 (Bias1)	928.58	856.44	807.39	670.53	630.06	563.14	542.30	519.91	547.77	533.25	730.30
N° 3 (Bias1)	551.40	494.54	431.83	392.55	341.26	306.29	280.85	263.42	293.39	292.14	419.91
N° 4 (Bias1)	585.25	493.38	511.75	406.98	383.35	342.34	324.86	330.51	328.60	328.85	456.04
N° 5 (Bias1)	664.30	593.65	551.30	449.78	380.42	254.69	235.38	219.64	342.74	345.50	490.95
N° 6 (Bias1)	579.01	483.43	495.08	396.99	362.02	323.48	303.23	314.67	308.91	313.07	436.36
N° 7 (Bias2)	590.15	572.63	564.29	415.23	299.16	272.76	246.24	226.94	264.30	279.69	472.08
N° 8 (Bias2)	395.98	374.81	390.01	280.88	236.97	188.07	163.46	138.91	155.47	164.13	347.71
N° 9 (Bias2)	337.72	306.34	295.04	199.54	170.53	112.71	79.30	67.40	104.65	110.28	240.94
N° 10 (Bias2)	452.10	368.61	377.93	271.61	202.44	131.16	129.27	156.47	143.13	148.73	287.31
N° 11 (Bias2)	399.51	346.99	315.65	211.26	163.43	116.19	83.75	107.78	103.26	109.67	245.41
N° 12 (OFF1)	494.08	433.30	411.05	303.36	211.93	163.16	130.88	159.49	154.65	162.47	312.31
N° 13 (OFF1)	543.91	476.82	452.60	336.43	242.76	174.67	154.15	145.68	176.31	185.92	339.57
N° 14 (OFF1)	504.72	476.39	440.93	315.97	269.86	161.16	114.75	100.17	128.28	134.69	266.69
N° 15 (OFF1)	608.33	553.36	509.53	381.38	332.89	274.46	269.69	245.62	239.59	268.86	395.90
N° 16 (OFF1)	567.73	511.32	465.34	332.24	286.54	207.11	198.65	195.75	175.33	187.25	353.63

1/Delta [CTR2]

	0krad(Si)	10krad(Si)	19krad(Si)	49krad(Si)	65krad(Si)	101krad(Si)	130krad(Si)	152krad(Si)	203krad(Si)	24h/25°C	168h/100°C
N° 1 (Ref)	---	6.943E-5	-5.813E-6	3.893E-5	3.826E-5	1.257E-4	5.098E-5	7.927E-5	-1.484E-5	-1.098E-5	-1.950E-5
N° 2 (Bias1)	---	9.072E-5	1.616E-4	4.144E-4	5.102E-4	6.988E-4	7.671E-4	8.465E-4	7.487E-4	7.984E-4	2.924E-4
N° 3 (Bias1)	---	2.085E-4	5.022E-4	7.339E-4	1.117E-3	1.451E-3	1.747E-3	1.983E-3	1.595E-3	1.609E-3	5.679E-4
N° 4 (Bias1)	---	3.182E-4	2.454E-4	7.485E-4	8.999E-4	1.212E-3	1.370E-3	1.317E-3	1.335E-3	1.332E-3	4.841E-4
N° 5 (Bias1)	---	1.792E-4	3.086E-4	7.180E-4	1.123E-3	2.421E-3	2.743E-3	3.047E-3	1.412E-3	1.389E-3	5.315E-4
N° 6 (Bias1)	---	3.415E-4	2.928E-4	7.919E-4	1.035E-3	1.364E-3	1.571E-3	1.451E-3	1.510E-3	1.467E-3	5.646E-4
N° 7 (Bias2)	---	5.182E-5	7.763E-5	7.138E-4	1.648E-3	1.972E-3	2.367E-3	2.712E-3	2.089E-3	1.881E-3	4.238E-4
N° 8 (Bias2)	---	1.426E-4	3.871E-5	1.035E-3	1.695E-3	2.792E-3	3.592E-3	4.674E-3	3.907E-3	3.568E-3	3.506E-4
N° 9 (Bias2)	---	3.033E-4	4.283E-4	2.051E-3	2.903E-3	5.911E-3	9.650E-3	1.187E-2	6.595E-3	6.106E-3	1.189E-3
N° 10 (Bias2)	---	5.010E-4	4.341E-4	1.470E-3	2.728E-3	5.412E-3	5.524E-3	4.179E-3	4.775E-3	4.512E-3	1.269E-3
N° 11 (Bias2)	---	3.788E-4	6.650E-4	2.230E-3	3.616E-3	6.103E-3	9.437E-3	6.775E-3	7.181E-3	6.615E-3	1.572E-3
N° 12 (OFF1)	---	2.839E-4	4.089E-4	1.272E-3	2.695E-3	4.105E-3	5.617E-3	4.246E-3	4.442E-3	4.131E-3	1.178E-3
N° 13 (OFF1)	---	2.587E-4	3.709E-4	1.134E-3	2.281E-3	3.887E-3	4.649E-3	5.026E-3	3.833E-3	3.540E-3	1.106E-3
N° 14 (OFF1)	---	1.178E-4	2.866E-4	1.184E-3	1.724E-3	4.224E-3	6.733E-3	8.001E-3	5.814E-3	5.443E-3	1.768E-3
N° 15 (OFF1)	---	1.633E-4	3.187E-4	9.782E-4	1.360E-3	2.000E-3	2.064E-3	2.427E-3	2.530E-3	2.076E-3	8.821E-4
N° 16 (OFF1)	---	1.943E-4	3.875E-4	1.248E-3	1.728E-3	3.067E-3	3.273E-3	3.347E-3	3.942E-3	3.579E-3	1.066E-3
Average (OFF1)	---	2.276E-4	3.021E-4	6.813E-4	9.371E-4	1.430E-3	1.640E-3	1.729E-3	1.320E-3	1.319E-3	4.881E-4
σ (OFF1)	---	1.032E-4	1.256E-4	1.517E-4	2.550E-4	6.263E-4	7.191E-4	8.409E-4	3.342E-4	3.092E-4	1.145E-4
Average+3σ (OFF1)	---	5.373E-4	6.789E-4	1.136E-3	1.702E-3	3.308E-3	3.797E-3	4.252E-3	2.323E-3	2.247E-3	8.316E-4
Average-3σ (OFF1)	---	-8.205E-5	-7.466E-5	2.262E-4	1.720E-4	-4.492E-4	-5.177E-4	-7.939E-4	3.174E-4	3.916E-4	1.447E-4
Average (Bias1)	---	2.755E-4	3.288E-4	1.500E-3	2.518E-3	4.438E-3	6.114E-3	6.043E-3	4.909E-3	4.536E-3	9.609E-4
σ (Bias1)	---	1.803E-4	2.652E-4	6.465E-4	8.414E-4	1.916E-3	3.328E-3	3.570E-3	2.060E-3	1.922E-3	5.434E-4
Average+3σ (Bias1)	---	8.163E-4	1.124E-3	3.439E-3	5.042E-3	1.019E-2	1.610E-2	1.675E-2	1.109E-2	1.030E-2	2.591E-3
Average-3σ (Bias1)	---	-2.653E-4	-4.668E-4	-4.397E-4	-6.329E-6	-1.310E-3	-3.869E-3	-4.668E-3	-1.271E-3	-1.230E-3	-6.692E-4
Average (Bias2)	---	2.036E-4	3.545E-4	1.163E-3	1.958E-3	3.456E-3	4.467E-3	4.610E-3	4.112E-3	3.754E-3	1.200E-3
σ (Bias2)	---	6.811E-5	5.049E-5	1.170E-4	5.272E-4	9.312E-4	1.850E-3	2.131E-3	1.185E-3	1.213E-3	3.359E-4
Average+3σ (Bias2)	---	4.079E-4	5.060E-4	1.514E-3	3.539E-3	6.250E-3	1.002E-2	1.100E-2	7.667E-3	7.394E-3	2.208E-3
Average-3σ (Bias2)	---	-7.361E-7	2.031E-4	8.124E-4	3.762E-4	6.629E-4	-1.083E-3	-1.784E-3	5.578E-4	1.136E-4	1.926E-4

14.CTR3

Ta=25°C; Vce = 5V; If = 10 mA

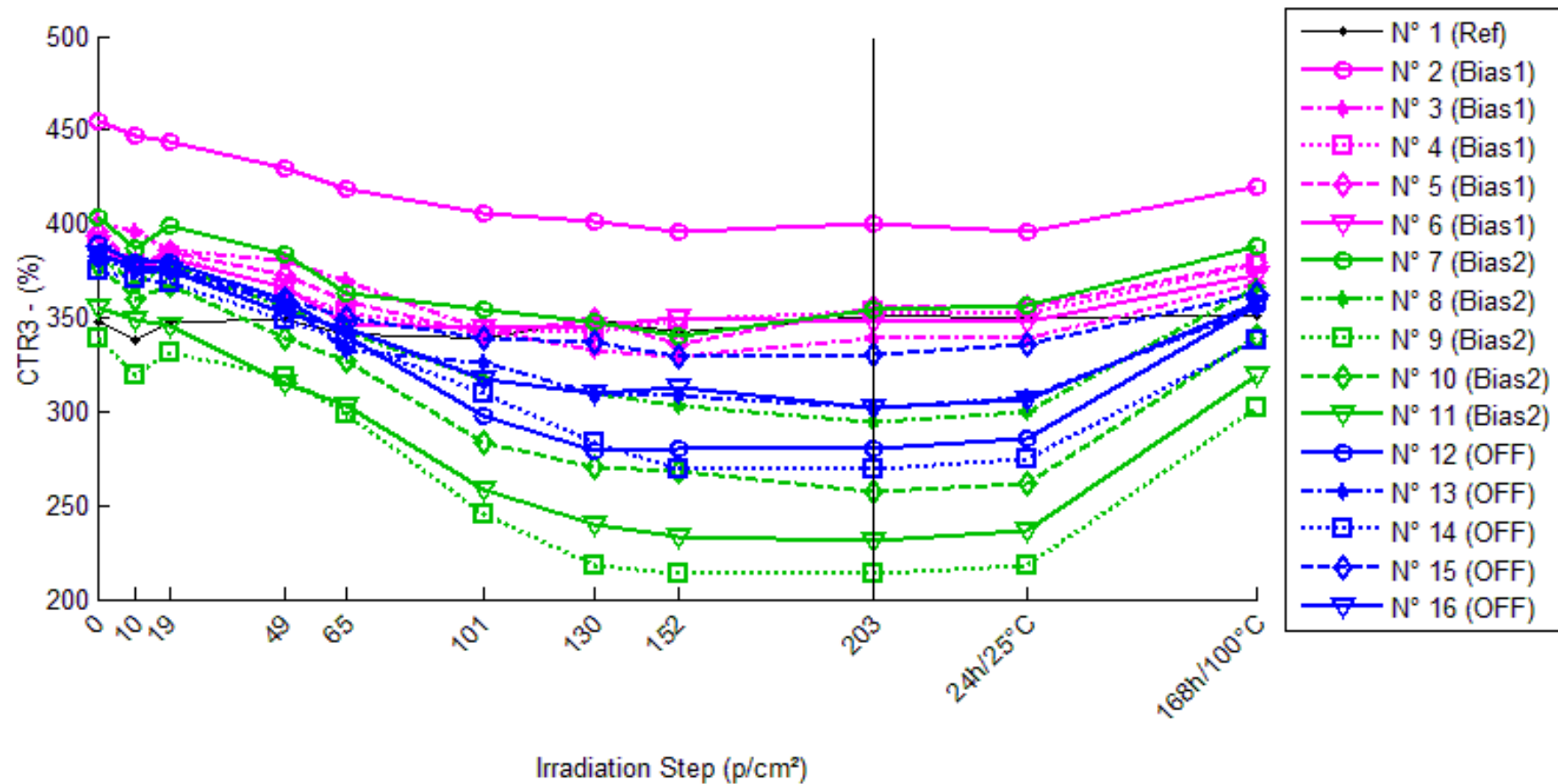

CTR3 . (%)

	0krad(Si)	10krad(Si)	19krad(Si)	49krad(Si)	65krad(Si)	101krad(Si)	130krad(Si)	152krad(Si)	203krad(Si)	24h/25°C	168h/100°C
N° 1 (Ref)	348.03	338.08	347.44	348.37	340.85	338.92	349.12	342.80	350.59	350.41	351.18
N° 2 (Bias1)	454.48	447.53	444.25	429.91	418.68	405.94	401.68	396.26	400.44	396.00	419.43
N° 3 (Bias1)	401.38	395.53	385.79	380.27	369.42	343.13	332.77	328.78	339.55	339.00	368.41
N° 4 (Bias1)	390.69	378.01	383.25	365.64	352.54	343.08	342.33	349.36	352.98	351.69	377.91
N° 5 (Bias1)	395.93	378.27	384.77	373.05	358.31	341.24	348.85	335.51	355.73	355.14	379.44
N° 6 (Bias1)	389.78	376.46	381.25	366.91	346.25	344.21	345.92	349.56	347.68	347.30	373.23
N° 7 (Bias2)	403.90	387.00	398.67	383.87	362.59	354.81	347.69	340.66	354.70	356.20	387.65
N° 8 (Bias2)	383.74	367.48	378.82	355.05	342.57	317.24	309.26	302.88	294.68	299.65	366.30
N° 9 (Bias2)	339.05	319.12	331.08	318.72	298.78	244.90	218.19	213.24	213.99	218.15	302.06
N° 10 (Bias2)	378.85	359.85	367.27	339.02	327.46	283.05	270.49	268.67	257.15	261.66	339.82
N° 11 (Bias2)	355.66	348.80	345.29	314.60	302.89	258.33	239.89	233.66	230.95	236.20	319.97
N° 12 (OFF1)	389.12	379.73	378.99	359.40	339.85	298.12	278.60	279.76	280.04	285.64	356.92
N° 13 (OFF1)	383.27	374.67	374.44	357.85	333.01	326.43	309.86	308.18	301.92	307.04	355.88
N° 14 (OFF1)	374.80	370.35	368.18	348.96	337.71	310.06	283.92	269.14	269.21	274.22	338.03
N° 15 (OFF1)	382.96	376.86	375.99	359.95	349.82	339.64	337.24	329.40	330.76	335.79	362.63
N° 16 (OFF1)	383.45	377.46	375.17	352.49	344.81	316.90	309.44	313.34	301.51	306.20	358.15

1/Delta [CTR3]

	0krad(Si)	10krad(Si)	19krad(Si)	49krad(Si)	65krad(Si)	101krad(Si)	130krad(Si)	152krad(Si)	203krad(Si)	24h/25°C	168h/100°C
N° 1 (Ref)	---	8.456E-5	4.851E-6	-2.839E-6	6.050E-5	7.724E-5	-9.030E-6	4.382E-5	-2.102E-5	-1.952E-5	-2.584E-5
N° 2 (Bias1)	---	3.418E-5	5.070E-5	1.258E-4	1.881E-4	2.631E-4	2.893E-4	3.233E-4	2.970E-4	3.249E-4	1.839E-4
N° 3 (Bias1)	---	3.685E-5	1.007E-4	1.383E-4	2.156E-4	4.229E-4	5.137E-4	5.502E-4	4.537E-4	4.584E-4	2.230E-4
N° 4 (Bias1)	---	8.588E-5	4.970E-5	1.753E-4	2.770E-4	3.552E-4	3.615E-4	3.028E-4	2.734E-4	2.838E-4	8.655E-5
N° 5 (Bias1)	---	1.179E-4	7.323E-5	1.549E-4	2.652E-4	4.048E-4	3.408E-4	4.548E-4	2.854E-4	2.900E-4	1.098E-4
N° 6 (Bias1)	---	9.077E-5	5.736E-5	1.599E-4	3.225E-4	3.396E-4	3.252E-4	2.952E-4	3.106E-4	3.137E-4	1.137E-4
N° 7 (Bias2)	---	1.081E-4	3.245E-5	1.292E-4	2.821E-4	3.425E-4	4.002E-4	4.596E-4	3.434E-4	3.316E-4	1.038E-4
N° 8 (Bias2)	---	1.153E-4	3.386E-5	2.106E-4	3.132E-4	5.462E-4	6.276E-4	6.957E-4	7.875E-4	7.313E-4	1.241E-4
N° 9 (Bias2)	---	1.842E-4	7.096E-5	1.882E-4	3.975E-4	1.134E-3	1.634E-3	1.740E-3	1.724E-3	1.635E-3	3.612E-4
N° 10 (Bias2)	---	1.394E-4	8.318E-5	3.101E-4	4.142E-4	8.933E-4	1.057E-3	1.083E-3	1.249E-3	1.182E-3	3.031E-4
N° 11 (Bias2)	---	5.526E-5	8.441E-5	3.669E-4	4.898E-4	1.059E-3	1.357E-3	1.468E-3	1.518E-3	1.422E-3	3.136E-4
N° 12 (OFF1)	---	6.358E-5	6.870E-5	2.125E-4	3.726E-4	7.845E-4	1.020E-3	1.005E-3	1.001E-3	9.311E-4	2.319E-4
N° 13 (OFF1)	---	5.992E-5	6.151E-5	1.854E-4	3.938E-4	4.543E-4	6.181E-4	6.357E-4	7.030E-4	6.478E-4	2.008E-4
N° 14 (OFF1)	---	3.200E-5	4.797E-5	1.975E-4	2.930E-4	5.571E-4	8.540E-4	1.047E-3	1.046E-3	9.786E-4	2.902E-4
N° 15 (OFF1)	---	4.225E-5	4.835E-5	1.669E-4	2.473E-4	3.331E-4	3.539E-4	4.245E-4	4.121E-4	3.668E-4	1.463E-4
N° 16 (OFF1)	---	4.137E-5	5.759E-5	2.291E-4	2.923E-4	5.477E-4	6.238E-4	5.835E-4	7.087E-4	6.580E-4	1.843E-4
Average (OFF1)	---	7.312E-5	6.633E-5	1.508E-4	2.537E-4	3.571E-4	3.661E-4	3.853E-4	3.240E-4	3.342E-4	1.434E-4
σ (OFF1)	---	3.645E-5	2.137E-5	1.926E-5	5.282E-5	6.275E-5	8.661E-5	1.127E-4	7.380E-5	7.146E-5	5.748E-5
Average+3σ (OFF1)	---	1.825E-4	1.304E-4	2.086E-4	4.121E-4	5.454E-4	6.259E-4	7.233E-4	5.454E-4	5.486E-4	3.158E-4
Average-3σ (OFF1)	---	-3.622E-5	2.216E-6	9.305E-5	9.522E-5	1.689E-4	1.063E-4	4.722E-5	1.026E-4	1.198E-4	-2.908E-5
Average (Bias1)	---	1.205E-4	6.097E-5	2.410E-4	3.794E-4	7.951E-4	1.015E-3	1.089E-3	1.124E-3	1.060E-3	2.412E-4
σ (Bias1)	---	4.704E-5	2.594E-5	9.596E-5	8.303E-5	3.395E-4	5.073E-4	5.288E-4	5.597E-4	5.279E-4	1.184E-4
Average+3σ (Bias1)	---	2.616E-4	1.388E-4	5.288E-4	6.285E-4	1.814E-3	2.537E-3	2.676E-3	2.804E-3	2.644E-3	5.964E-4
Average-3σ (Bias1)	---	-2.065E-5	-1.684E-5	-4.690E-5	1.303E-4	-2.234E-4	-5.067E-4	-4.971E-4	-5.548E-4	-5.235E-4	-1.140E-4
Average (Bias2)	---	4.783E-5	5.682E-5	1.983E-4	3.198E-4	5.353E-4	6.939E-4	7.392E-4	7.743E-4	7.164E-4	2.107E-4
σ (Bias2)	---	1.340E-5	8.857E-6	2.401E-5	6.123E-5	1.660E-4	2.539E-4	2.736E-4	2.579E-4	2.476E-4	5.410E-5
Average+3σ (Bias2)	---	8.801E-5	8.339E-5	2.703E-4	5.035E-4	1.033E-3	1.456E-3	1.560E-3	1.548E-3	1.459E-3	3.730E-4
Average-3σ (Bias2)	---	7.639E-6	3.025E-5	1.262E-4	1.361E-4	3.739E-5	-6.789E-5	-8.162E-5	5.169E-7	-2.629E-5	4.841E-5

15.CTR4

Ta=25°C; Vce = 5V; If = 50 mA

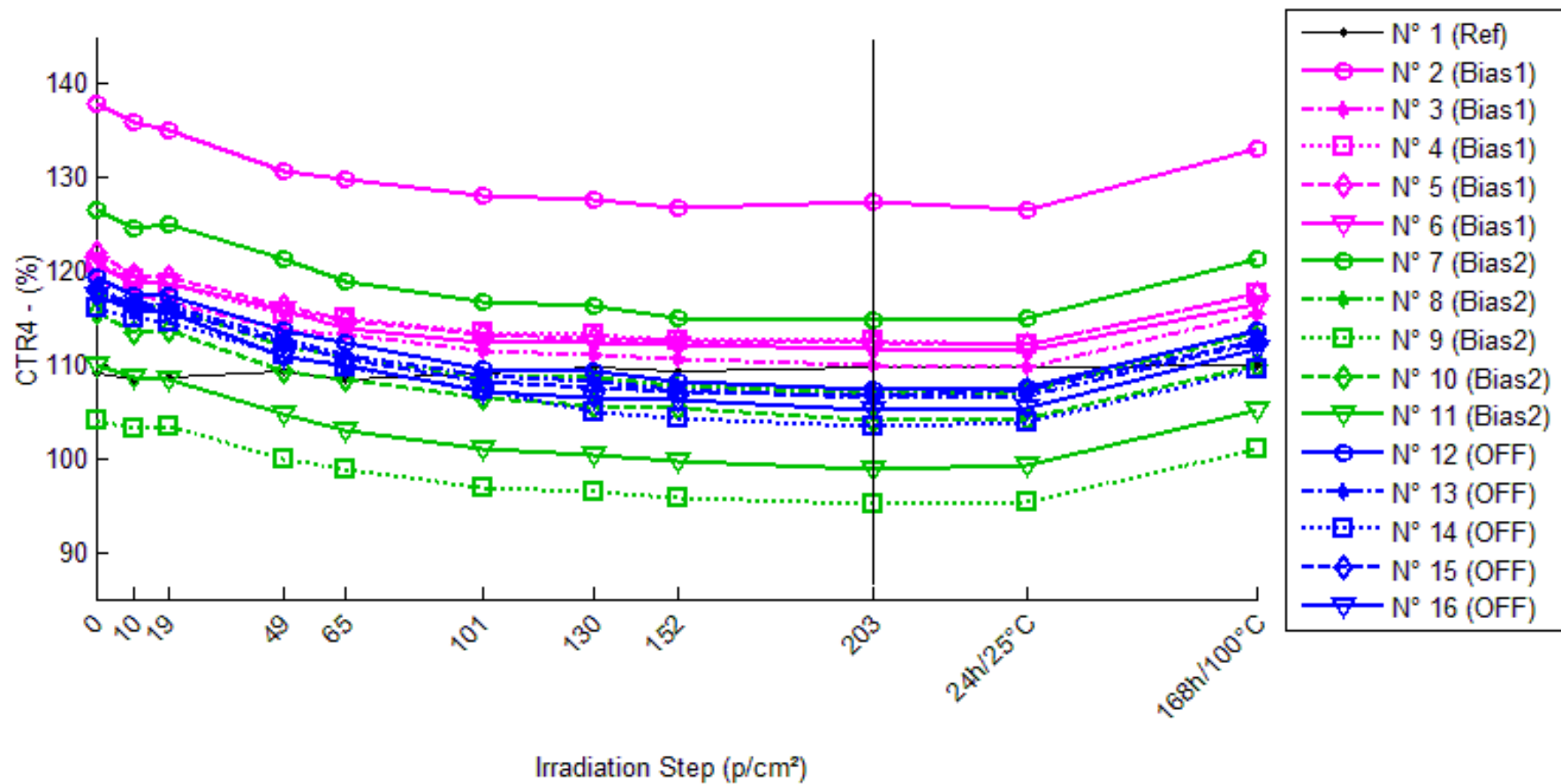

CTR4 . (%)

	0krad(Si)	10krad(Si)	19krad(Si)	49krad(Si)	65krad(Si)	101krad(Si)	130krad(Si)	152krad(Si)	203krad(Si)	24h/25°C	168h/100°C
N° 1 (Ref)	109.02	108.37	108.77	109.42	108.48	109.03	109.79	109.42	109.76	109.72	109.97
N° 2 (Bias1)	137.85	135.92	135.02	130.65	129.93	128.09	127.58	126.77	127.34	126.47	133.01
N° 3 (Bias1)	119.08	117.57	116.68	113.60	113.20	111.61	111.14	110.58	110.02	109.70	115.39
N° 4 (Bias1)	120.92	119.18	118.77	115.48	115.08	113.49	113.19	112.64	112.51	112.07	117.51
N° 5 (Bias1)	121.97	119.58	119.32	116.40	114.76	113.17	112.93	112.51	112.36	112.17	117.63
N° 6 (Bias1)	120.68	118.73	118.65	115.87	113.80	112.31	112.44	112.21	111.71	111.48	116.59
N° 7 (Bias2)	126.65	124.56	125.03	121.29	119.02	116.64	116.27	114.98	114.89	114.95	121.41
N° 8 (Bias2)	117.85	116.14	116.41	112.00	111.11	108.69	108.70	107.83	106.96	107.11	113.49
N° 9 (Bias2)	104.04	103.13	103.34	100.04	98.82	96.99	96.52	95.86	95.23	95.46	101.02
N° 10 (Bias2)	115.70	113.40	113.72	109.40	108.44	106.52	105.61	105.36	104.07	104.33	109.97
N° 11 (Bias2)	109.90	108.76	108.53	104.79	103.11	101.10	100.47	99.82	98.88	99.29	105.16
N° 12 (OFF1)	119.40	117.49	117.50	113.67	112.37	109.58	109.42	108.20	107.28	107.66	113.68
N° 13 (OFF1)	118.34	116.31	116.36	112.77	111.13	108.89	108.23	107.26	106.40	106.78	112.44
N° 14 (OFF1)	116.18	114.99	114.64	111.05	109.72	107.27	105.05	104.37	103.54	103.93	109.63
N° 15 (OFF1)	118.02	116.33	115.95	112.36	110.65	108.25	107.67	107.14	106.63	107.28	112.56
N° 16 (OFF1)	117.40	115.82	115.60	110.93	109.94	107.20	106.42	106.31	105.16	105.31	111.71

1/Delta [CTR4]

	0krad(Si)	10krad(Si)	19krad(Si)	49krad(Si)	65krad(Si)	101krad(Si)	130krad(Si)	152krad(Si)	203krad(Si)	24h/25°C	168h/100°C
N° 1 (Ref)	---	5.563E-5	2.126E-5	-3.289E-5	4.617E-5	-4.122E-7	-6.423E-5	-3.298E-5	-6.176E-5	-5.787E-5	-7.869E-5
N° 2 (Bias1)	---	1.027E-4	1.521E-4	3.998E-4	4.419E-4	5.529E-4	5.839E-4	6.337E-4	5.989E-4	6.525E-4	2.638E-4
N° 3 (Bias1)	---	1.079E-4	1.727E-4	4.051E-4	4.363E-4	5.625E-4	6.006E-4	6.460E-4	6.919E-4	7.187E-4	2.687E-4
N° 4 (Bias1)	---	1.209E-4	1.501E-4	3.899E-4	4.200E-4	5.414E-4	5.650E-4	6.082E-4	6.186E-4	6.533E-4	2.401E-4
N° 5 (Bias1)	---	1.638E-4	1.825E-4	3.927E-4	5.150E-4	6.373E-4	6.566E-4	6.892E-4	7.014E-4	7.161E-4	3.028E-4
N° 6 (Bias1)	---	1.364E-4	1.415E-4	3.442E-4	5.007E-4	6.179E-4	6.071E-4	6.256E-4	6.656E-4	6.838E-4	2.905E-4
N° 7 (Bias2)	---	1.323E-4	1.023E-4	3.488E-4	5.065E-4	6.776E-4	7.053E-4	8.014E-4	8.083E-4	8.035E-4	3.408E-4
N° 8 (Bias2)	---	1.255E-4	1.056E-4	4.433E-4	5.148E-4	7.152E-4	7.148E-4	7.891E-4	8.639E-4	8.507E-4	3.265E-4
N° 9 (Bias2)	---	8.428E-5	6.505E-5	3.843E-4	5.072E-4	6.982E-4	7.489E-4	8.201E-4	8.890E-4	8.640E-4	2.872E-4
N° 10 (Bias2)	---	1.751E-4	1.504E-4	4.978E-4	5.784E-4	7.444E-4	8.261E-4	8.481E-4	9.657E-4	9.417E-4	4.500E-4
N° 11 (Bias2)	---	9.564E-5	1.151E-4	4.436E-4	5.993E-4	7.922E-4	8.537E-4	9.193E-4	1.014E-3	9.724E-4	4.098E-4
N° 12 (OFF1)	---	1.358E-4	1.350E-4	4.219E-4	5.239E-4	7.502E-4	7.639E-4	8.666E-4	9.457E-4	9.134E-4	4.210E-4
N° 13 (OFF1)	---	1.476E-4	1.442E-4	4.173E-4	5.480E-4	7.336E-4	7.895E-4	8.729E-4	9.487E-4	9.146E-4	4.435E-4
N° 14 (OFF1)	---	8.913E-5	1.155E-4	3.972E-4	5.065E-4	7.143E-4	9.119E-4	9.733E-4	1.051E-3	1.015E-3	5.138E-4
N° 15 (OFF1)	---	1.233E-4	1.515E-4	4.270E-4	5.650E-4	7.650E-4	8.146E-4	8.606E-4	9.056E-4	8.488E-4	4.111E-4
N° 16 (OFF1)	---	1.162E-4	1.322E-4	4.963E-4	5.774E-4	8.106E-4	8.782E-4	8.880E-4	9.908E-4	9.775E-4	4.335E-4
Average (OFF1)	---	1.263E-4	1.598E-4	3.864E-4	4.628E-4	5.824E-4	6.027E-4	6.406E-4	6.553E-4	6.849E-4	2.732E-4
σ (OFF1)	---	2.465E-5	1.712E-5	2.433E-5	4.222E-5	4.247E-5	3.430E-5	3.048E-5	4.499E-5	3.225E-5	2.438E-5
Average+3σ (OFF1)	---	2.003E-4	2.111E-4	4.593E-4	5.894E-4	7.098E-4	7.056E-4	7.320E-4	7.902E-4	7.816E-4	3.463E-4
Average-3σ (OFF1)	---	5.238E-5	1.084E-4	3.134E-4	3.361E-4	4.550E-4	4.998E-4	5.491E-4	5.203E-4	5.881E-4	2.000E-4
Average (Bias1)	---	1.226E-4	1.077E-4	4.236E-4	5.412E-4	7.255E-4	7.697E-4	8.356E-4	9.083E-4	8.865E-4	3.629E-4
σ (Bias1)	---	3.553E-5	3.053E-5	5.797E-5	4.419E-5	4.460E-5	6.677E-5	5.180E-5	8.199E-5	6.911E-5	6.582E-5
Average+3σ (Bias1)	---	2.292E-4	1.993E-4	5.975E-4	6.738E-4	8.593E-4	9.701E-4	9.910E-4	1.154E-3	1.094E-3	5.603E-4
Average-3σ (Bias1)	---	1.597E-5	1.609E-5	2.497E-4	4.087E-4	5.917E-4	5.694E-4	6.802E-4	6.623E-4	6.791E-4	1.654E-4
Average (Bias2)	---	1.224E-4	1.357E-4	4.319E-4	5.442E-4	7.547E-4	8.316E-4	8.923E-4	9.683E-4	9.338E-4	4.446E-4
σ (Bias2)	---	2.213E-5	1.363E-5	3.770E-5	2.908E-5	3.649E-5	6.177E-5	4.642E-5	5.498E-5	6.408E-5	4.059E-5
Average+3σ (Bias2)	---	1.888E-4	1.766E-4	5.450E-4	6.314E-4	8.642E-4	1.017E-3	1.032E-3	1.133E-3	1.126E-3	5.664E-4
Average-3σ (Bias2)	---	5.602E-5	9.480E-5	3.188E-4	4.569E-4	6.453E-4	6.463E-4	7.530E-4	8.033E-4	7.415E-4	3.228E-4

16.CTR5

Ta=25°C; Vce = 30V; If = 10 mA

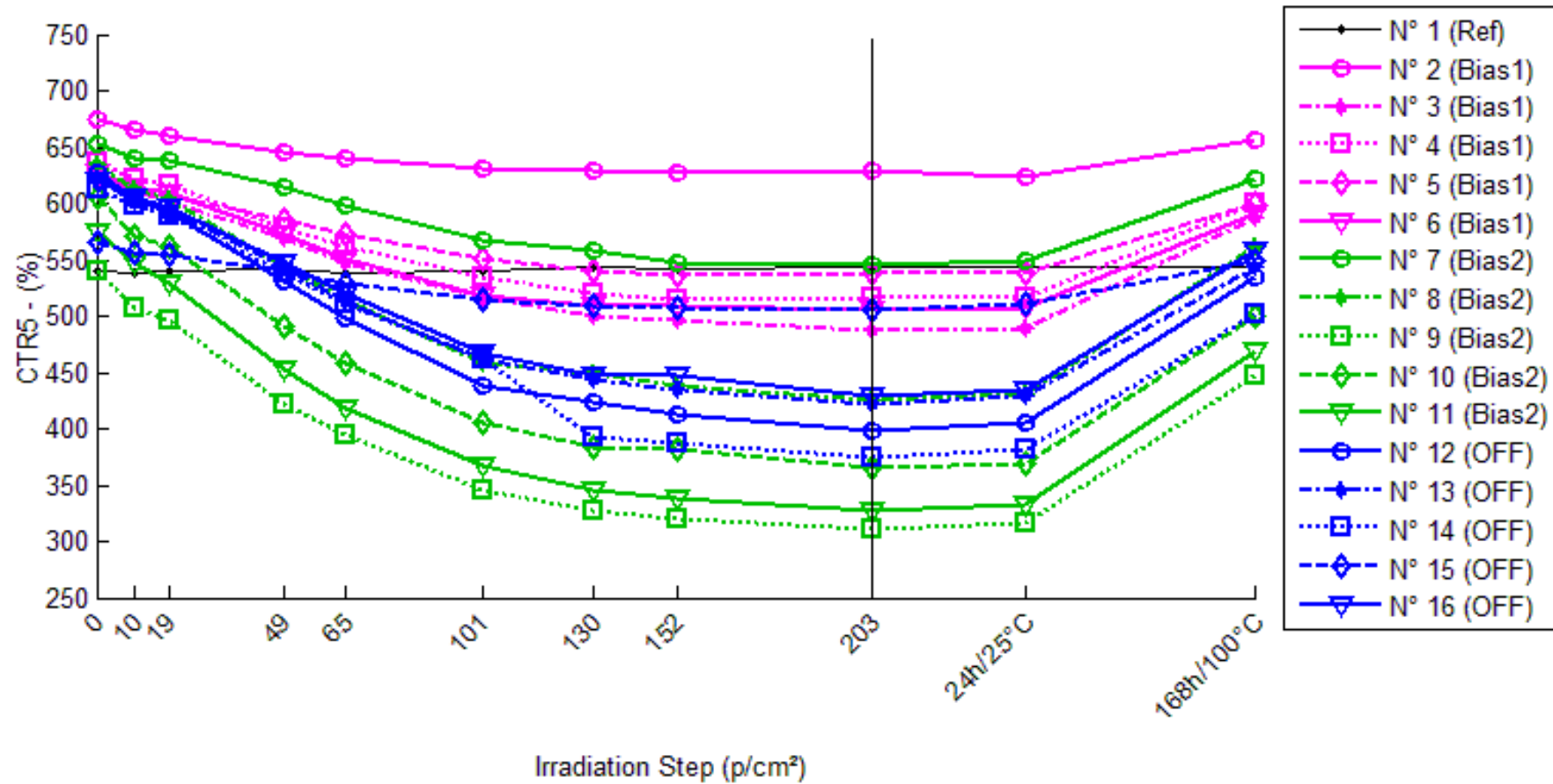

CTR5 . (%)

	0krad(Si)	10krad(Si)	19krad(Si)	49krad(Si)	65krad(Si)	101krad(Si)	130krad(Si)	152krad(Si)	203krad(Si)	24h/25°C	168h/100°C
N° 1 (Ref)	540.15	537.59	539.76	541.62	537.60	539.86	542.76	541.26	543.65	543.34	544.52
N° 2 (Bias1)	674.10	665.26	660.64	645.04	640.33	631.41	629.37	626.38	628.97	623.81	656.20
N° 3 (Bias1)	623.32	611.36	602.40	568.21	548.03	515.73	500.14	495.57	488.16	489.56	587.09
N° 4 (Bias1)	635.59	622.18	616.27	577.47	561.99	533.90	519.98	514.27	515.49	515.57	600.47
N° 5 (Bias1)	623.11	611.27	606.78	585.14	573.35	550.20	540.00	537.19	537.51	538.13	600.74
N° 6 (Bias1)	627.75	613.69	608.95	572.48	551.23	517.74	509.06	509.59	506.35	507.15	591.63
N° 7 (Bias2)	652.63	640.04	638.05	614.17	597.74	567.54	558.89	547.99	545.09	548.43	621.95
N° 8 (Bias2)	634.01	611.86	604.36	544.12	514.28	457.97	448.31	437.44	426.17	431.39	562.45
N° 9 (Bias2)	539.39	507.94	495.50	422.55	394.75	344.59	327.26	319.90	311.49	316.73	447.39
N° 10 (Bias2)	604.74	571.34	561.57	490.66	458.23	405.89	383.51	381.01	364.55	369.80	500.70
N° 11 (Bias2)	574.43	546.65	529.35	453.25	418.89	366.50	345.24	339.02	326.68	333.51	469.55
N° 12 (OFF1)	627.66	603.41	592.05	531.29	497.39	438.42	423.73	412.39	399.08	405.78	534.54
N° 13 (OFF1)	621.74	602.43	595.24	543.10	512.68	462.63	444.17	434.73	421.74	428.45	543.95
N° 14 (OFF1)	612.81	598.19	588.87	537.33	511.29	460.92	392.74	387.23	375.23	381.48	502.48
N° 15 (OFF1)	565.99	556.63	553.73	540.10	528.20	514.34	509.57	507.61	506.19	510.01	548.44
N° 16 (OFF1)	619.49	605.37	597.24	546.52	519.65	466.61	447.16	447.83	429.49	435.15	557.92

1/Delta [CTR5]

	0krad(Si)	10krad(Si)	19krad(Si)	49krad(Si)	65krad(Si)	101krad(Si)	130krad(Si)	152krad(Si)	203krad(Si)	24h/25°C	168h/100°C
N° 1 (Ref)	---	8.809E-6	1.330E-6	-5.009E-6	8.800E-6	1.018E-6	-8.881E-6	-3.777E-6	-1.193E-5	-1.086E-5	-1.486E-5
N° 2 (Bias1)	---	1.972E-5	3.023E-5	6.684E-5	7.824E-5	1.003E-4	1.054E-4	1.130E-4	1.065E-4	1.196E-4	4.047E-5
N° 3 (Bias1)	---	3.139E-5	5.570E-5	1.556E-4	2.204E-4	3.347E-4	3.951E-4	4.136E-4	4.442E-4	4.383E-4	9.899E-5
N° 4 (Bias1)	---	3.390E-5	4.931E-5	1.583E-4	2.060E-4	2.996E-4	3.498E-4	3.711E-4	3.665E-4	3.663E-4	9.202E-5
N° 5 (Bias1)	---	3.110E-5	4.321E-5	1.042E-4	1.393E-4	2.127E-4	2.470E-4	2.567E-4	2.556E-4	2.534E-4	5.976E-5
N° 6 (Bias1)	---	3.650E-5	4.918E-5	1.538E-4	2.211E-4	3.385E-4	3.714E-4	3.694E-4	3.819E-4	3.788E-4	9.724E-5
N° 7 (Bias2)	---	3.016E-5	3.502E-5	9.596E-5	1.407E-4	2.297E-4	2.570E-4	2.926E-4	3.023E-4	2.911E-4	7.559E-5
N° 8 (Bias2)	---	5.708E-5	7.737E-5	2.605E-4	3.672E-4	6.063E-4	6.533E-4	7.088E-4	7.692E-4	7.408E-4	2.007E-4
N° 9 (Bias2)	---	1.148E-4	1.642E-4	5.127E-4	6.793E-4	1.048E-3	1.202E-3	1.272E-3	1.356E-3	1.303E-3	3.812E-4
N° 10 (Bias2)	---	9.667E-5	1.271E-4	3.845E-4	5.287E-4	8.101E-4	9.539E-4	9.710E-4	1.090E-3	1.051E-3	3.436E-4
N° 11 (Bias2)	---	8.848E-5	1.483E-4	4.654E-4	6.464E-4	9.877E-4	1.156E-3	1.209E-3	1.320E-3	1.258E-3	3.889E-4
N° 12 (OFF1)	---	6.402E-5	9.584E-5	2.890E-4	4.173E-4	6.877E-4	7.668E-4	8.317E-4	9.126E-4	8.711E-4	2.775E-4
N° 13 (OFF1)	---	5.155E-5	7.160E-5	2.329E-4	3.422E-4	5.532E-4	6.430E-4	6.919E-4	7.628E-4	7.256E-4	2.300E-4
N° 14 (OFF1)	---	3.989E-5	6.635E-5	2.292E-4	3.240E-4	5.377E-4	9.144E-4	9.507E-4	1.033E-3	9.896E-4	3.583E-4
N° 15 (OFF1)	---	2.971E-5	3.912E-5	8.469E-5	1.264E-4	1.774E-4	1.956E-4	2.032E-4	2.087E-4	1.939E-4	5.654E-5
N° 16 (OFF1)	---	3.767E-5	6.013E-5	2.155E-4	3.101E-4	5.289E-4	6.221E-4	6.188E-4	7.141E-4	6.838E-4	1.781E-4
Average (OFF1)	---	3.052E-5	4.553E-5	1.277E-4	1.730E-4	2.572E-4	2.938E-4	3.048E-4	3.109E-4	3.113E-4	7.770E-5
σ (OFF1)	---	6.419E-6	9.625E-6	4.079E-5	6.279E-5	1.013E-4	1.195E-4	1.220E-4	1.330E-4	1.263E-4	2.621E-5
Average+3 σ (OFF1)	---	4.978E-5	7.440E-5	2.501E-4	3.614E-4	5.609E-4	6.522E-4	6.706E-4	7.099E-4	6.902E-4	1.563E-4
Average-3 σ (OFF1)	---	1.126E-5	1.665E-5	5.368E-6	-1.535E-5	-4.660E-5	-6.465E-5	-6.111E-5	-8.807E-5	-6.764E-5	-9.398E-7
Average (Bias1)	---	7.744E-5	1.104E-4	3.438E-4	4.725E-4	7.364E-4	8.443E-4	8.906E-4	9.676E-4	9.287E-4	2.780E-4
σ (Bias1)	---	3.369E-5	5.335E-5	1.683E-4	2.221E-4	3.314E-4	3.931E-4	4.012E-4	4.394E-4	4.199E-4	1.362E-4
Average+3 σ (Bias1)	---	1.785E-4	2.705E-4	8.487E-4	1.139E-3	1.731E-3	2.024E-3	2.094E-3	2.286E-3	2.188E-3	6.866E-4
Average-3 σ (Bias1)	---	-2.362E-5	-4.964E-5	-1.611E-4	-1.939E-4	-2.579E-4	-3.350E-4	-3.130E-4	-3.508E-4	-3.309E-4	-1.306E-4
Average (Bias2)	---	4.457E-5	6.661E-5	2.103E-4	3.040E-4	4.970E-4	6.284E-4	6.592E-4	7.263E-4	6.928E-4	2.201E-4
σ (Bias2)	---	1.339E-5	2.047E-5	7.561E-5	1.075E-4	1.900E-4	2.686E-4	2.852E-4	3.155E-4	3.041E-4	1.129E-4
Average+3 σ (Bias2)	---	8.475E-5	1.280E-4	4.371E-4	6.266E-4	1.067E-3	1.434E-3	1.515E-3	1.673E-3	1.605E-3	5.589E-4
Average-3 σ (Bias2)	---	4.389E-6	5.185E-6	-1.655E-5	-1.865E-5	-7.287E-5	-1.773E-4	-1.963E-4	-2.203E-4	-2.195E-4	-1.187E-4

17.TRR

Ta=25°C; If = 5 mA; RL = 100 Ohms; Irec = 10% Irm

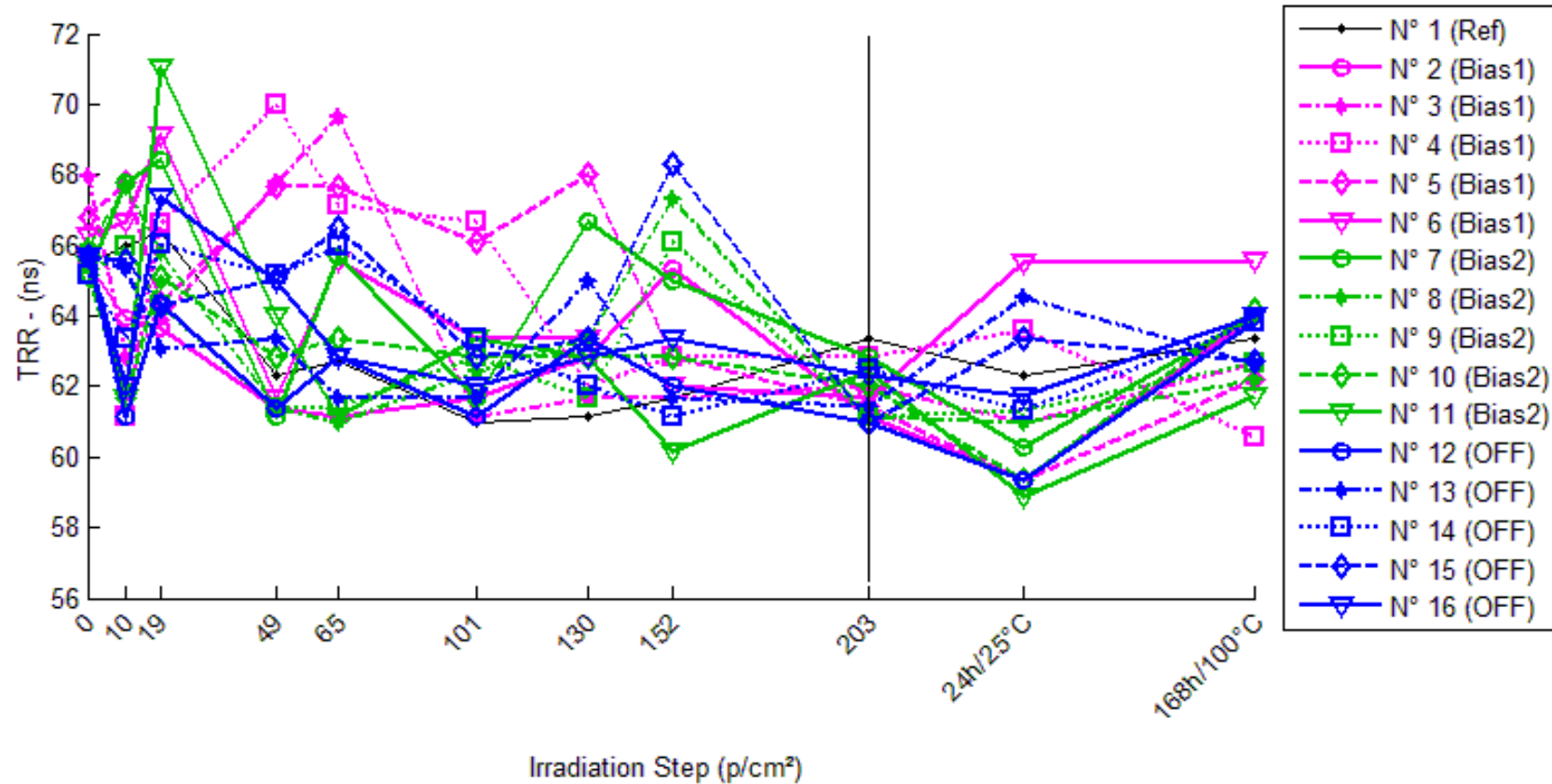

TRR . (ns)

	0krad(Si)	10krad(Si)	19krad(Si)	49krad(Si)	65krad(Si)	101krad(Si)	130krad(Si)	152krad(Si)	203krad(Si)	24h/25°C	168h/100°C
N° 1 (Ref)	65.4	66.0	66.4	62.3	62.7	61.0	61.2	61.7	63.3	62.3	63.4
N° 2 (Bias1)	65.4	63.9	63.7	61.4	61.2	61.7	62.8	65.3	61.2	59.3	64.0
N° 3 (Bias1)	67.9	62.8	63.9	67.8	69.7	61.2	61.7	61.7	62.0	61.0	62.7
N° 4 (Bias1)	65.7	61.2	66.6	70.0	67.1	66.7	62.0	62.9	62.8	63.6	60.5
N° 5 (Bias1)	66.8	67.8	64.4	67.7	67.7	66.1	68.0	62.8	61.4	59.3	62.2
N° 6 (Bias1)	66.3	66.7	69.1	61.7	65.6	63.3	63.3	62.0	61.7	65.5	65.6
N° 7 (Bias2)	65.2	67.8	68.4	61.2	65.7	61.7	66.7	65.0	62.8	60.3	64.0
N° 8 (Bias2)	66.0	67.7	65.8	61.4	61.0	62.4	63.3	67.3	61.2	61.0	62.2
N° 9 (Bias2)	65.2	66.0	64.3	61.4	61.4	62.8	61.7	66.1	61.2	61.3	62.7
N° 10 (Bias2)	65.2	61.7	65.1	62.8	63.4	62.8	62.8	62.9	62.0	59.3	64.2
N° 11 (Bias2)	65.4	61.7	71.0	64.0	61.2	63.3	62.8	60.1	62.4	58.9	61.7
N° 12 (OFF1)	65.7	61.2	64.4	61.4	62.8	61.2	63.4	62.0	61.0	59.3	63.9
N° 13 (OFF1)	65.7	65.3	63.1	63.4	61.7	61.7	65.0	61.7	61.4	64.5	62.7
N° 14 (OFF1)	65.2	63.4	66.1	65.2	66.0	63.3	62.0	61.2	62.5	61.3	63.9
N° 15 (OFF1)	65.7	65.6	64.3	65.1	66.5	62.8	63.3	68.3	61.0	63.4	62.7
N° 16 (OFF1)	65.7	62.0	67.4	65.0	62.8	62.0	62.8	63.3	62.3	61.7	64.0

Delta [TRR]

	0krad(Si)	10krad(Si)	19krad(Si)	49krad(Si)	65krad(Si)	101krad(Si)	130krad(Si)	152krad(Si)	203krad(Si)	24h/25°C	168h/100°C
N° 1 (Ref)	---	5.714E-1	9.601E-1	-3.133E+0	-2.683E+0	-4.436E+0	-4.272E+0	-3.762E+0	-2.095E+0	-3.091E+0	-2.052E+0
N° 2 (Bias1)	---	-1.494E+0	-1.753E+0	-4.042E+0	-4.272E+0	-3.762E+0	-2.619E+0	-8.204E-2	-4.272E+0	-6.095E+0	-1.429E+0
N° 3 (Bias1)	---	-5.125E+0	-4.056E+0	-1.658E-1	1.732E+0	-6.777E+0	-6.268E+0	-6.268E+0	-5.934E+0	-6.934E+0	-5.268E+0
N° 4 (Bias1)	---	-4.510E+0	9.712E-1	4.333E+0	1.476E+0	1.000E+0	-3.667E+0	-2.810E+0	-2.857E+0	-2.067E+0	-5.121E+0
N° 5 (Bias1)	---	9.587E-1	-2.441E+0	8.760E-1	8.760E-1	-6.942E-1	1.190E+0	-4.000E+0	-5.381E+0	-7.477E+0	-4.612E+0
N° 6 (Bias1)	---	3.716E-1	2.834E+0	-4.628E+0	-7.213E-1	-2.962E+0	-2.962E+0	-4.295E+0	-4.628E+0	-7.909E-1	-7.206E-1
N° 7 (Bias2)	---	2.612E+0	3.283E+0	-4.000E+0	5.573E-1	-3.490E+0	1.510E+0	-1.570E-1	-2.347E+0	-4.871E+0	-1.157E+0
N° 8 (Bias2)	---	1.667E+0	-1.893E-1	-4.614E+0	-5.007E+0	-3.589E+0	-2.667E+0	1.327E+0	-4.843E+0	-5.000E+0	-3.802E+0
N° 9 (Bias2)	---	8.430E-1	-8.430E-1	-3.771E+0	-3.728E+0	-2.347E+0	-3.490E+0	9.587E-1	-4.000E+0	-3.838E+0	-2.490E+0
N° 10 (Bias2)	---	-3.490E+0	-5.809E-2	-2.347E+0	-1.777E+0	-2.347E+0	-2.347E+0	-2.300E+0	-3.157E+0	-5.824E+0	-1.001E+0
N° 11 (Bias2)	---	-3.762E+0	5.594E+0	-1.429E+0	-4.272E+0	-2.095E+0	-2.619E+0	-5.289E+0	-3.017E+0	-6.536E+0	-3.691E+0
N° 12 (OFF1)	---	-4.510E+0	-1.292E+0	-4.281E+0	-2.857E+0	-4.510E+0	-2.300E+0	-3.667E+0	-4.674E+0	-6.333E+0	-1.815E+0
N° 13 (OFF1)	---	-3.201E-1	-2.599E+0	-2.300E+0	-4.000E+0	-4.000E+0	-6.667E-1	-4.000E+0	-4.238E+0	-1.130E+0	-3.000E+0
N° 14 (OFF1)	---	-1.791E+0	9.032E-1	3.110E-2	8.430E-1	-1.818E+0	-3.157E+0	-4.000E+0	-2.657E+0	-3.838E+0	-1.306E+0
N° 15 (OFF1)	---	-9.290E-2	-1.402E+0	-5.923E-1	8.333E-1	-2.857E+0	-2.333E+0	2.667E+0	-4.674E+0	-2.290E+0	-2.929E+0
N° 16 (OFF1)	---	-3.667E+0	1.730E+0	-6.667E-1	-2.857E+0	-3.667E+0	-2.857E+0	-2.333E+0	-3.372E+0	-3.929E+0	-1.667E+0
Average (OFF1)	---	-1.960E+0	-8.890E-1	-7.255E-1	-1.817E-1	-2.639E+0	-2.865E+0	-3.491E+0	-4.614E+0	-4.673E+0	-3.430E+0
σ (OFF1)	---	2.770E+0	2.762E+0	3.698E+0	2.477E+0	2.980E+0	2.680E+0	2.275E+0	1.177E+0	3.036E+0	2.178E+0
Average+3σ (OFF1)	---	6.350E+0	7.396E+0	1.037E+1	7.250E+0	6.300E+0	5.176E+0	3.334E+0	-1.085E+0	4.434E+0	3.105E+0
Average-3σ (OFF1)	---	-1.027E+1	-9.174E+0	-1.182E+1	-7.614E+0	-1.158E+1	-1.091E+1	-1.032E+1	-8.144E+0	-1.378E+1	-9.965E+0
Average (Bias1)	---	-4.262E-1	1.557E+0	-3.232E+0	-2.845E+0	-2.774E+0	-1.923E+0	-1.092E+0	-3.473E+0	-5.214E+0	-2.428E+0
σ (Bias1)	---	2.989E+0	2.770E+0	1.306E+0	2.248E+0	7.075E-1	1.966E+0	2.739E+0	9.656E-1	1.022E+0	1.336E+0
Average+3σ (Bias1)	---	8.541E+0	9.867E+0	6.867E-1	3.897E+0	-6.513E-1	3.975E+0	7.124E+0	-5.760E-1	-2.148E+0	1.579E+0
Average-3σ (Bias1)	---	-9.393E+0	-6.753E+0	-7.151E+0	-9.588E+0	-4.896E+0	-7.820E+0	-9.308E+0	-6.370E+0	-8.279E+0	-6.436E+0
Average (Bias2)	---	-2.076E+0	-5.318E-1	-1.562E+0	-1.607E+0	-3.370E+0	-2.263E+0	-2.267E+0	-3.923E+0	-3.504E+0	-2.143E+0
σ (Bias2)	---	1.972E+0	1.788E+0	1.748E+0	2.281E+0	1.055E+0	9.626E-1	2.842E+0	8.851E-1	1.963E+0	7.726E-1
Average+3σ (Bias2)	---	3.839E+0	4.831E+0	3.681E+0	5.235E+0	-2.041E-1	6.250E-1	6.260E+0	-1.268E+0	2.384E+0	1.743E-1
Average-3σ (Bias2)	---	-7.991E+0	-5.894E+0	-6.804E+0	-8.450E+0	-6.536E+0	-5.151E+0	-1.079E+1	-6.578E+0	-9.392E+0	-4.461E+0