

TOTAL IONIZING DOSE TEST REPORT

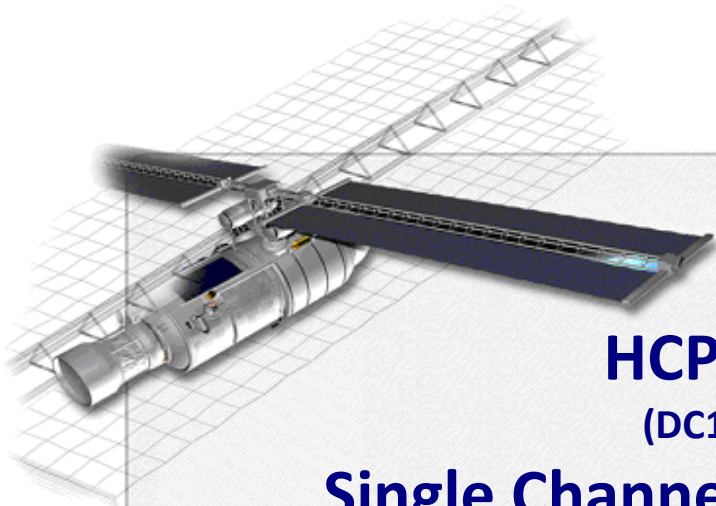

HCPL5701 (DC1116) Single Channel Optocoupler From AVAGO



TRAD/TE/HCPL5701/XXX1/ESA/YP/1104		Labège, April 19th, 2012
 		TRAD, Bât Gallium 907, Voie l'Occitane - 31670 LABEGE France ☎ : 05 61 00 95 60 Fax : 05 61 00 95 61 Email : trad@trad.fr Web Site: www.trad.fr SIRET 397 862 038 00056 - TVA FR59397862038
Written by	Verified by / Quality control	Approved by
A. SAMARAS 27/04/2012	M.SAUVAGNAC/Y.PADIE 29/05/2012	C.CHATRY 29/05/2012
Issue : 0		
To: Marc POIZAT	Project/Program:	ESA Contract N°4000102571/10/NL/AF-Radiation Characterization of Laplace RH optocouplers, sensors and detectors

TABLE OF CONTENT

1	INTRODUCTION	3
2	DOCUMENTS	3
2.1	Applicable Documents	3
2.2	Reference Documents.....	3
3	DEVICE INFORMATION	3
3.1	Device description.....	3
3.2	Procurement information	4
3.3	External view.....	4
3.4	Internal view	4
3.5	Serialization.....	5
4	IRRADIATION MEANS AND CONDITIONS	6
4.1	UCL irradiation facility (Belgium)	6
4.2	Dose measurement.....	6
4.3	Experimental conditions	6
5	ELECTRICAL TESTS	7
5.1	Test set-up	7
5.2	Test configuration.....	7
5.3	Electrical parameters	8
6	TEST HISTORY	8
7	SUMMARY RESULTS.....	9
8	CONCLUSION	10
9	DETAILED TESTS RESULTS	11

LIST OF FIGURES

Figure 1:	package marking.....	4
Figure 2:	package back side	4
Figure 3:	package view	4
Figure 4:	Internal overall view	4
Figure 5:	Internal view	4
Figure 6:	detail view of photodetector and LED	5
Figure 7:	test principle	7
Figure 8:	ON bias1	7
Figure 9:	ON bias2.....	7
Figure 10:	ON Bias 1	9
Figure 11:	ON Bias 2	9
Figure 12:	OFF Bias.....	9
Figure 13:	Average drift current transfer ratio function of the Bias condition and CTR configuration	10

1 INTRODUCTION

This report includes the test results of HCPL5701, a Single Channel Optocoupler from AVAGO to evaluate Total Ionizing Dose (TID) effects under ^{60}Co irradiation. Between November 2011 and February 2012, TRAD characterized this device for TID sensitivity at the UCL Facility, Belgium using their Gamma irradiation Facility.

The objectives of the test are:

- to detect and measure the degradation of device parameters as a function of TID,
- to determine if device parameters are within specified limits after exposure to final TID level.

2 DOCUMENTS

2.1 Applicable Documents

AD	1.	ESA contract	N°4000102571/10/NL/AF-Radiation Characterization of Laplace RH optocouplers, sensors and detectors
AD	2.	Irradiation Test Plan	ITP-TE-HCPL5701-AVA-ESA-1115-Issue 3 of 23/09/2011

2.2 Reference Documents

RD	1.	Datasheet HCPL5701	Hermetically Sealed, Low IF, Wide VCC, High Gain Optocouplers, Datasheet HCPL-5701 n°AV02-1766EN of february 26th, 2009 by Avago
RD	2.	Manufacturer's certificate of conformance dated 11/05/2011	

3 DEVICE INFORMATION

3.1 Device description

The HCPL5701 is a Single Channel hermetically High Gain Optocoupler containing a GaAsP light emitting diode which is optically coupled to an integrated high gain photon detector. The high gain output stage features an open collector output providing both lower saturation voltage and higher signaling speed than possible with conventional photo-Darlington optocouplers.

Type	HCPL5701 – 5962-8981001PC
Manufacturer	AVAGO
Function	Optocoupler
Package	DIP8
Date Code	1116
Lot :	HS111603D
LPN :	DS10741861
Sample size	16 parts (15 + 1 control sample)

3.2 Procurement information

75 parts HCPL5701 were procured from AVAGO (through ACAL BFI, Germany) with full MIL-PRF-38534 Class Level H testing. Parts were delivered with a certificate of conformance [RD2]. The class H is identifiable by the digit 1 at the end of the part reference.

3.3 External view



Figure 1: package marking



Figure 2: package back side

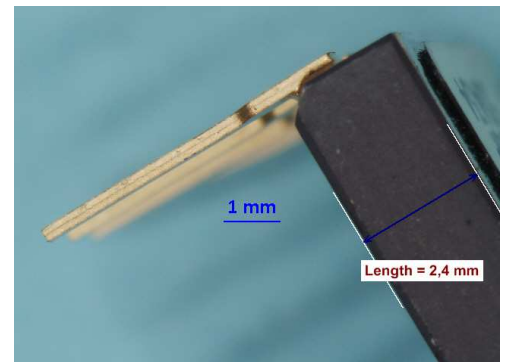

Figure 3: package view

3.4 Internal view

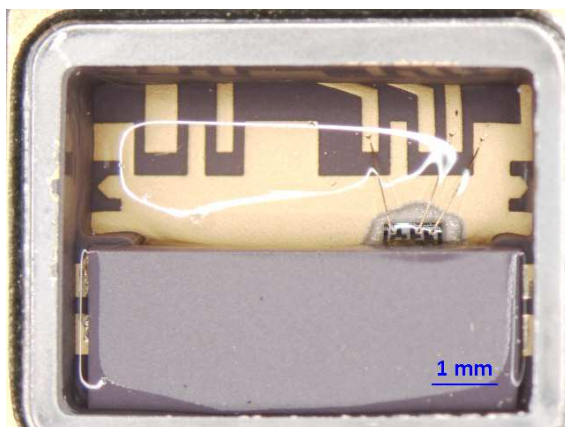

Figure 4: Internal overall view

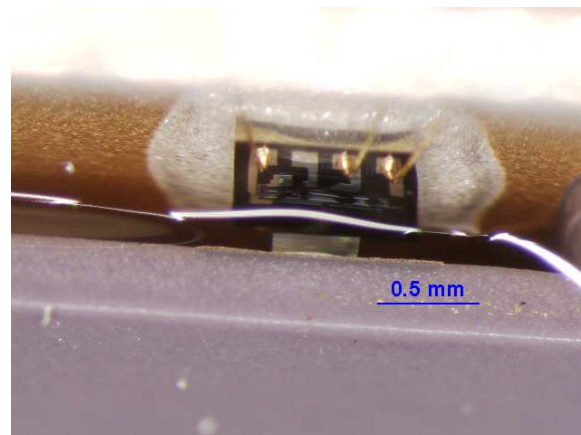

Figure 5: Internal view



Figure 6: detail view of photodetector and LED

3.5 Serialization

Each part is serialized to enable pre and post test identification and comparison.

Serial Number	Control sample	Test samples														
Serialization	1	2	3	4	5	6	7	8	9	10	11	12	13	14	15	16
	Ref	Bias1	Bias1	Bias1	Bias1	Bias1	Bias2	Bias2	Bias2	Bias2	Bias2	OFF	OFF	OFF	OFF	OFF

4 IRRADIATION MEANS AND CONDITIONS

4.1 UCL irradiation facility (Belgium)

Gamma irradiations are performed with Cobalt 60 source.
Gamma emitted radiation energies are 1.17 and 1.33 MeV.
Dose rates is equal 15 kRad(Si) / h at the source centre .
Moreover the irradiation chamber is a cylindrical room with a radius of 2m.
Then dose rate usable vary from 1.8 kRad(Si) / h to 80 Rad(Si) / h for normal irradiation positions and direct field.



4.2 Dose measurement

Alanine dosimeters are used for each test set up to control Total Ionizing Dose.

4.3 Experimental conditions

An Accumulated dose of 200 krad(Si) of ⁶⁰Co is required [AD2] for this TID (Total Ionizing Dose) evaluation test.

The devices were exposed to the following dose rates:

	Step1	Step2	Step3	Step4	Step5	Step6	Step7	Step8
Accumulated dose krad(Si)	10	19	49	65	101	130	152	203
Dose rate (Si)/h	36	36	36	36	310	310	310	310

Two annealing steps are performed after ⁶⁰Co irradiation:

Duration (h)	24	168
Temperature (°C)	25	100

5 ELECTRICAL TESTS

Electrical parameters to be measured in pre and post exposure tests are described in the following table. Electrical tests are performed on each part using the test set-up hereunder. All required data are recorded for each device. Test conditions and limits are given in the applicable irradiation test plan [AD2] and shown hereafter.

5.1 Test set-up

TEST BOARD	TRAD/CT1/E/OPTO/ZIP14/BR/1108
TEST PROGRAM	HCPL5701_TE_XXX1_B1_V10.IIb

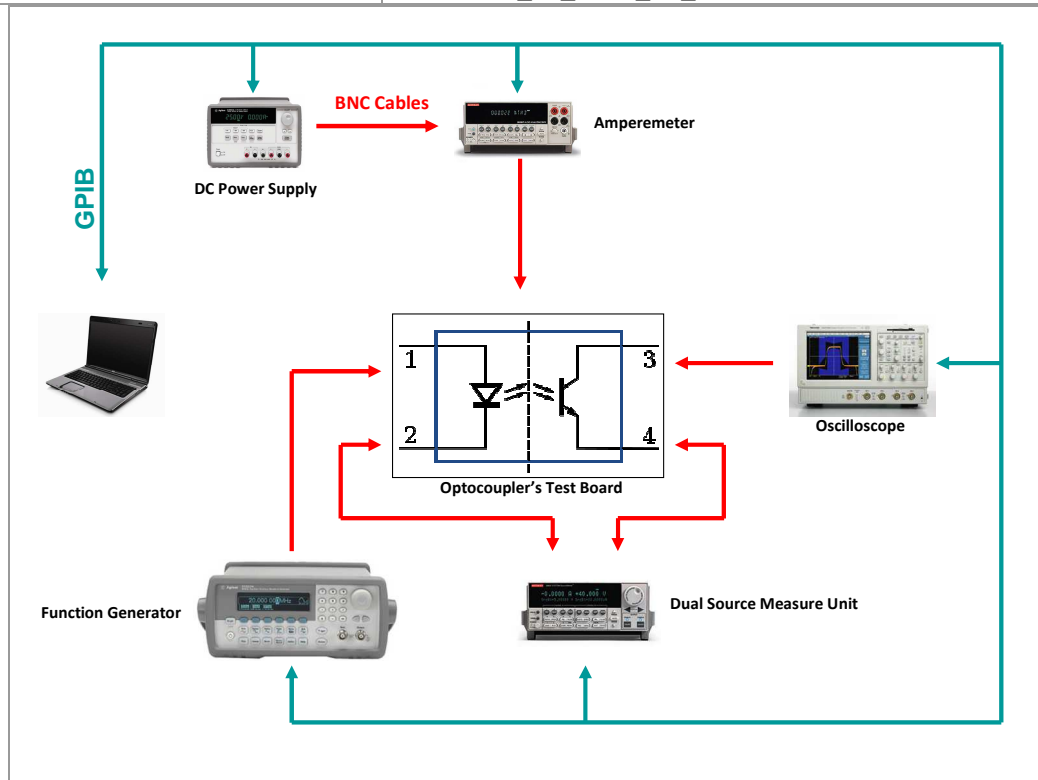

Figure 7: test principle

5.2 Test configuration

Samples were exposed to irradiation in three different modes - two on-modes (Figure 8 and Figure 9) and one in off-mode (all terminal leads short-circuited) -

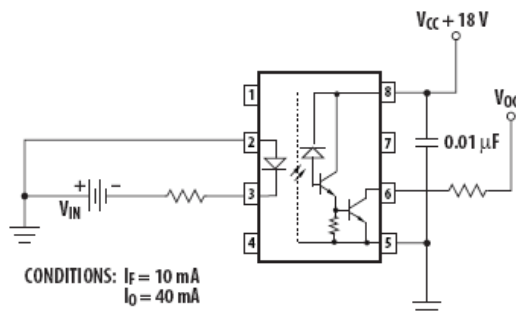

Figure 8: ON bias1

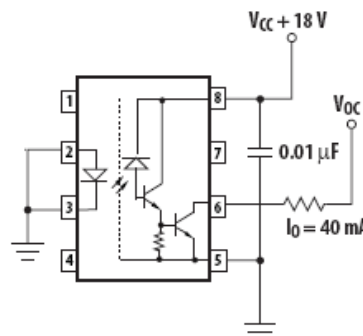

Figure 9: ON bias2

Conditions:
 $I_f = 0 \text{ mA}$
 $I_o = 0 \text{ mA}$
 $V_{CC} = V_{OC} = +5V$

5.3 Electrical parameters

PARAMETER	SYMBOL	TEST CONDITION	MIN	MAX	UNIT
Logic Low Output Voltage	V_{OL1}	$I_F=0.5\text{mA}$, $I_{OL}=1.5\text{mA}$, $V_{CC}=4.5\text{V}$		0.4	V
	V_{OL2}	$I_F=1.6\text{mA}$, $I_{OL}=4.8\text{mA}$, $V_{CC}=4.5\text{V}$		0.4	V
	V_{OL3}	$I_F=5\text{mA}$, $I_{OL}=10\text{mA}$, $V_{CC}=4.5\text{V}$		0.4	V
Logic High Output Current	I_{OH}	$I_F=2\mu\text{A}$, $V_O=18\text{V}$, $V_{CC}=18\text{V}$		250	μA
Logic Low Supply Current	I_{CCL}	$I_F=1.6\text{mA}$, $V_{CC}=18\text{V}$		2	mA
Logic High Supply Current	I_{CCH}	$I_F=0\text{mA}$, $V_{CC}=18\text{V}$		20	μA
Input Forward Voltage	V_F	$I_F=1.6\text{mA}$	1	1.7	V
Input Reverse Breakdown Voltage	B_{VR}	$I_R=10\mu\text{A}$	5		V
Propagation Delay Time to Logic Low at Output	t_{PHL1}	$I_F=0.5\text{mA}$, $R_L=4.7\text{k}\Omega$, $V_{CC}=5\text{V}$		100	μs
	t_{PHL2}	$I_F=1.6\text{mA}$, $R_L=1.5\text{k}\Omega$, $V_{CC}=5\text{V}$		30	μs
	t_{PHL3}	$I_F=5\text{mA}$, $R_L=680\Omega$, $V_{CC}=5\text{V}$		10	μs
Propagation Delay Time to Logic High at Output	t_{PLH1}	$I_F=0.5\text{mA}$, $R_L=4.7\text{k}\Omega$, $V_{CC}=5\text{V}$		60	μs
	t_{PLH2}	$I_F=1.6\text{mA}$, $R_L=1.5\text{k}\Omega$, $V_{CC}=5\text{V}$		50	μs
	t_{PLH3}	$I_F=5\text{mA}$, $R_L=680\Omega$, $V_{CC}=5\text{V}$		30	μs
Current Transfer Ratio	CTR1	$I_F=5\text{mA}$, $V_O=0.4\text{V}$, $V_{CC}=4.5\text{V}$	200		%
	CTR2	$I_F=0.5\text{mA}$, $V_O=0.4\text{V}$, $V_{CC}=5\text{V}$			%
	CTR3	$I_F=1\text{mA}$, $V_O=0.4\text{V}$, $V_{CC}=5\text{V}$			%
	CTR4	$I_F=5\text{mA}$, $V_O=0.4\text{V}$, $V_{CC}=5\text{V}$			%
	CTR5	$I_F=10\text{mA}$, $V_O=0.4\text{V}$, $V_{CC}=5\text{V}$			%
	CTR6	$I_F=5\text{mA}$, $V_O=0.4\text{V}$, $V_{CC}=18\text{V}$			%

(*) t_{PHL} propagation delay is measured from the 50% point on the rising edge of the input current pulse to the 1.5 V point on the falling edge of the output pulse. The t_{PLH} propagation delay is measured from the 50% point on the falling edge of the input current pulse to the 1.5 V point on the rising edge of the output pulse.

Min/ Max values are those specified in the reference data-sheet [RD1].

Test measurements are performed at $20^\circ\text{C} \pm 10^\circ\text{C}$.

6 TEST HISTORY

Seven steps were defined [AD2] to determine the component degradation under ^{60}Co irradiation.

	Step1	Step2	Step3	Step4	Step5	Step6	Step7
Accumulated dose krad(Si)	10	20	50	100	120	150	200
Dose rate (Si)/h	36	36	36	36	310	310	310

Due to irradiation facility maintenance, between Step 3 and Step 4 (50 krad(Si) and 100 krad(Si)), tests were stopped for 48 hours. Total Ionizing Dose was estimated at 65 krad(Si).

During this time period, parts were stocked in a cold chamber at -30°C .

7 SUMMARY RESULTS

Only parameters with applicable test limits are shown hereunder.

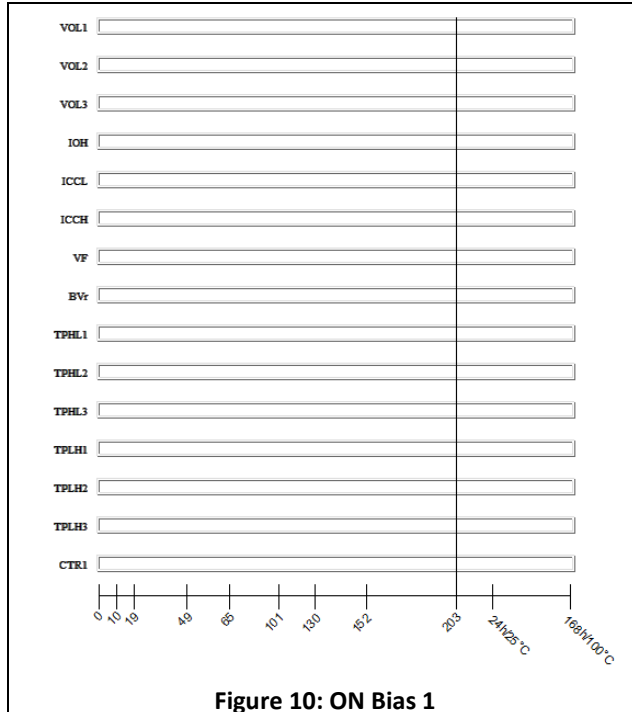

Figure 10: ON Bias 1

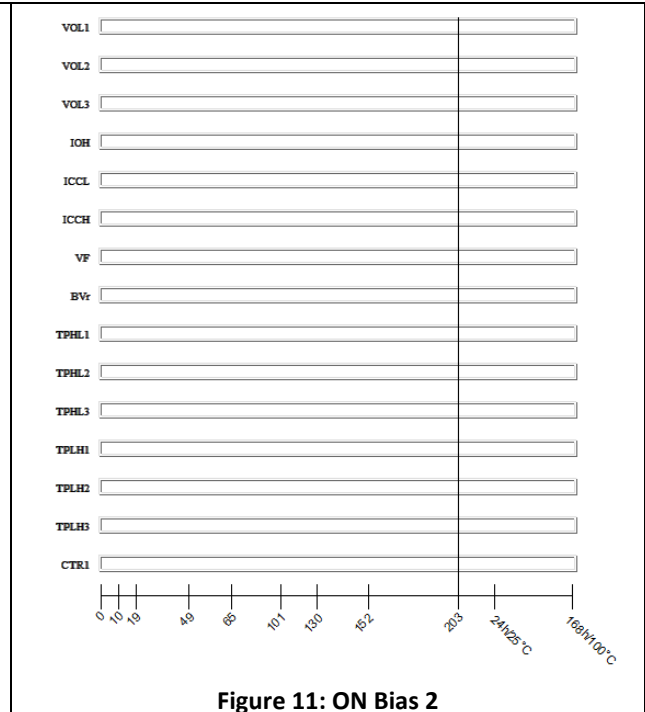

Figure 11: ON Bias 2

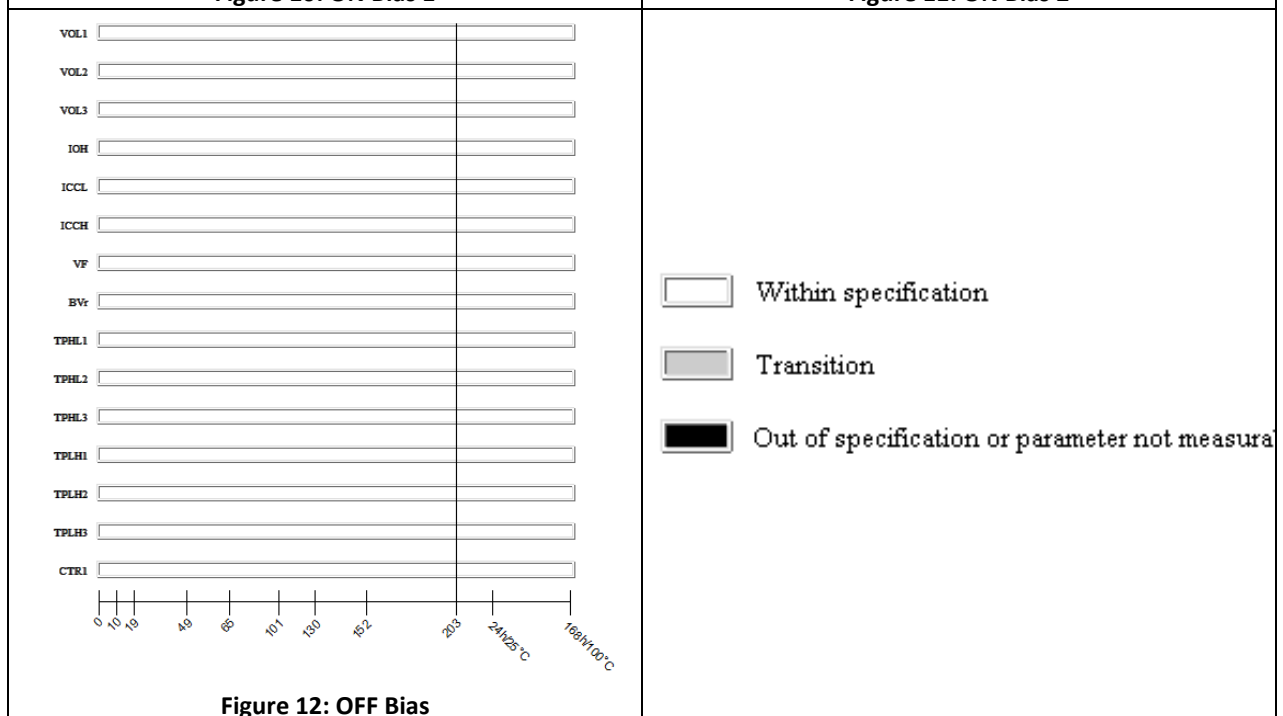

Figure 12: OFF Bias

All specified parameters [RD1] are within the limits up to 203 kRad(Si).

8 CONCLUSION

Total Ionizing Dose steady-state irradiation test using Gamma ray was applied on HCPL5701, a High Gain Optocoupler from Avago up to 200krad(Si) TID under three bias conditions.

The results indicate that:

- All parameters are within specified values at total dose level.
- Average drift current transfer ratio function of the Bias condition and CTR configuration are described in next Figure.

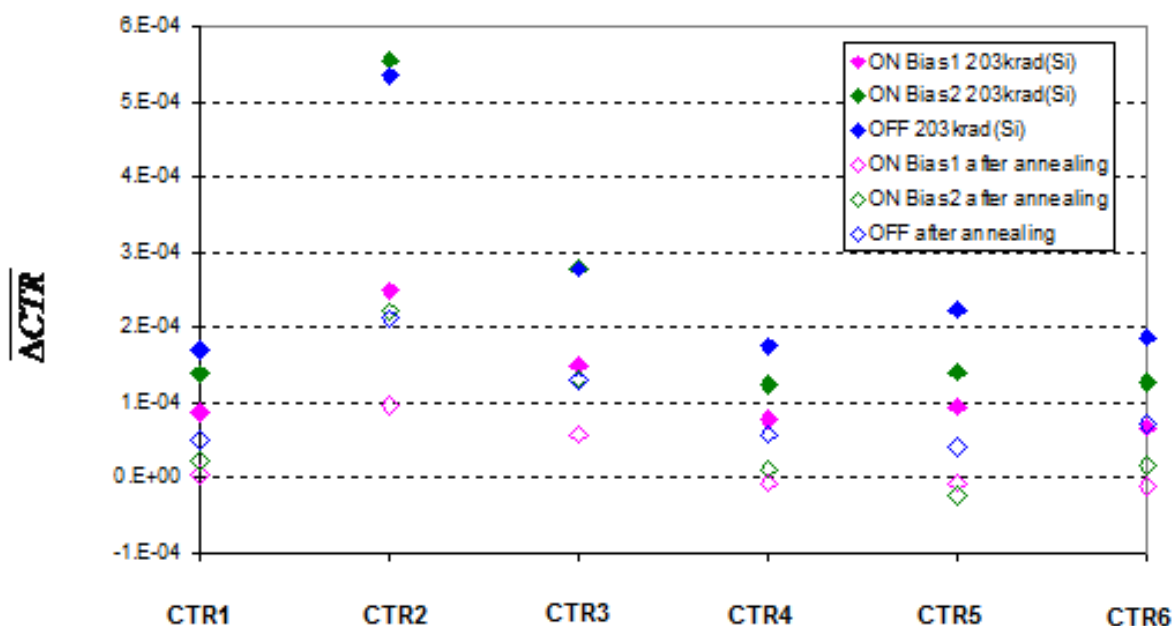

Figure 13: Average drift current transfer ratio function of the Bias condition and CTR configuration

- CTR6 configuration ($I_F = 5\text{mA}$, $V_O = 0.4\text{V}$, $V_{CC} = 18\text{V}$) is the least sensitive configuration at the final step 203 krad(Si).
- Conversely, CRT2 configuration ($I_F = 0.5\text{mA}$, $V_O = 0.4\text{V}$, $V_{CC} = 5\text{V}$) exhibits the greatest parameter degradation up to 203krad (Si) total dose.
- ON Bias1 configuration is the least sensitive configuration for all CTR configurations.
- OFF mode is the most sensitive configuration except for CTR2 condition
- ON Bias 2 mode is the most sensitive configuration for CTR2 condition.
- Moreover CTR1 ($I_F = 5\text{mA}$, $V_O = 0.4\text{V}$, $V_{CC} = 4.5\text{V}$), which specification limit is indicated in the data-sheet, remains within this limit at total dose level.

As shown in previous figure, after annealing, average drift Current Transfer Ratio decrease.

9 DETAILED TESTS RESULTS

The pre and post radiation test results are shown graphically in the following pages (9-2 to 9-41). The data is displayed in the following tables and graphs.

These graphs show parameter's shifts observed during the total ionizing dose sequence. The Control sample results are shown on each graph (black curve).

When available in the device data-sheet/specification, the maximum/minimum/typical values are also shown (red dotted line).

The tables include drift calculation between each measurement step and the "0" kRad(Si) step.

For CTR values, the formula used is:

$$\text{Drift} = \frac{1}{\text{measurement (X kRad(Si))}} - \frac{1}{\text{measurement (0 kRad(Si))}}$$

For other parameters, the formula used is:

$$\text{Drift value} = \text{measurement (X kRad(Si))} - \text{measurement (0 kRad(Si))}$$

CONTENTS

1. VOL1.....	2
2. VOL2.....	4
3. VOL3.....	6
4. IOH	8
5. ICCL	10
6. ICCH.....	12
7. VF	14
8. BVr	16
9. TPHL 1	18
10. TPHL2	20
11. TPHL3	22
12. TPLH1	24
13. TPLH2	26
14. TPLH3	28
15. CTR1	30
16. CTR2	32
17. CTR3	34
18. CTR4	36
19. CTR5	38
20. CTR6	40

1. VOL1

Ta=25°C; If = 0.5 mA; Iol = 1.5 mA; Vcc = 4.5 V

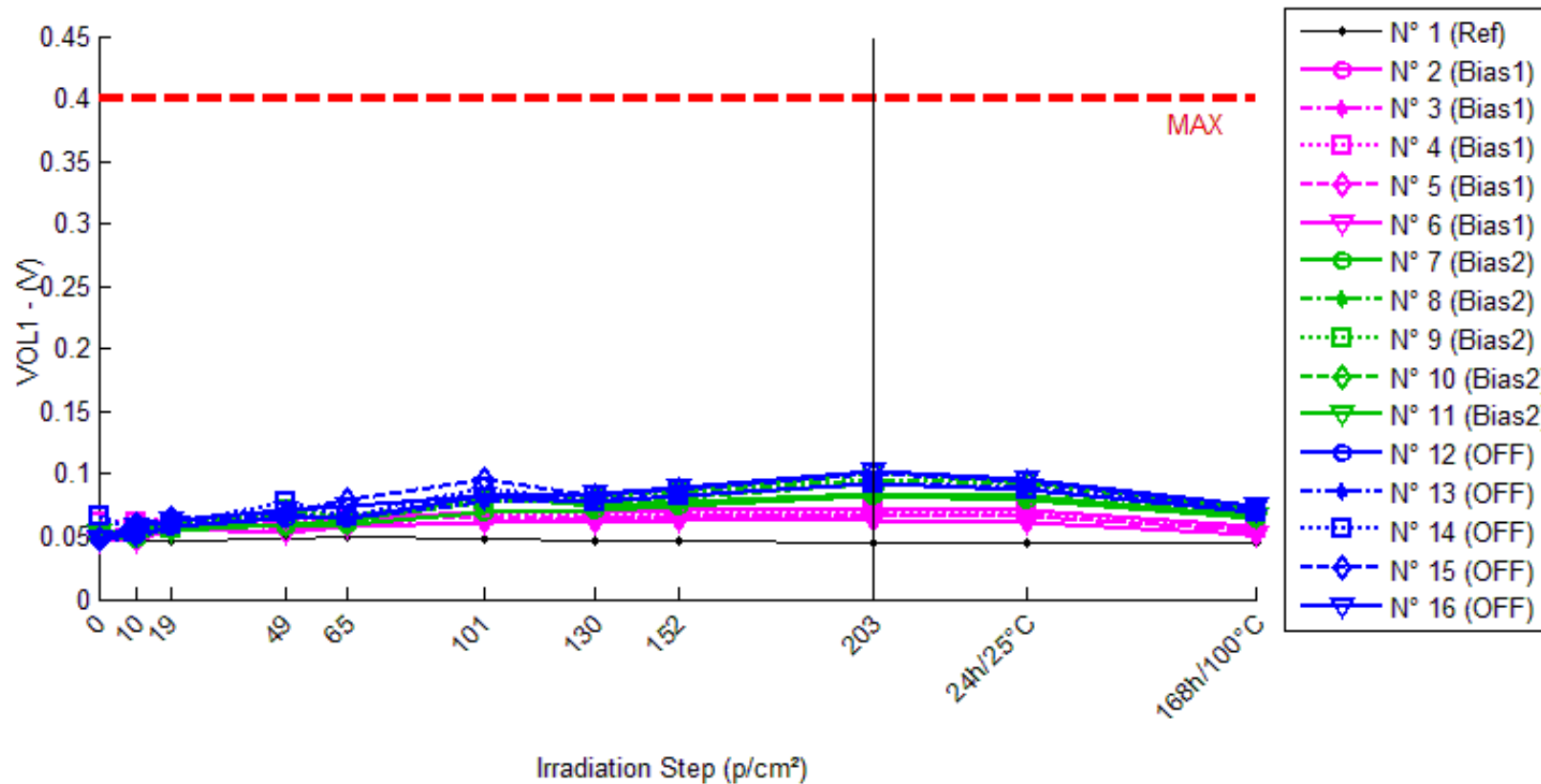

VOL1 . (V) Max = 0.4

	0krad(Si)	10krad(Si)	19krad(Si)	49krad(Si)	65krad(Si)	101krad(Si)	130krad(Si)	152krad(Si)	203krad(Si)	24h/25°C	168h/100°C
N° 1 (Ref)	0.046	0.046	0.047	0.048	0.050	0.048	0.047	0.047	0.045	0.045	0.045
N° 2 (Bias1)	0.051	0.055	0.058	0.058	0.065	0.069	0.069	0.071	0.072	0.071	0.058
N° 3 (Bias1)	0.050	0.061	0.064	0.056	0.060	0.062	0.064	0.066	0.067	0.066	0.055
N° 4 (Bias1)	0.062	0.061	0.056	0.062	0.064	0.067	0.068	0.070	0.071	0.070	0.057
N° 5 (Bias1)	0.053	0.056	0.062	0.060	0.065	0.065	0.065	0.067	0.068	0.067	0.055
N° 6 (Bias1)	0.047	0.046	0.056	0.053	0.058	0.062	0.061	0.063	0.063	0.062	0.052
N° 7 (Bias2)	0.048	0.048	0.058	0.058	0.059	0.070	0.072	0.075	0.083	0.080	0.064
N° 8 (Bias2)	0.053	0.053	0.057	0.070	0.065	0.081	0.082	0.086	0.096	0.092	0.071
N° 9 (Bias2)	0.054	0.055	0.056	0.072	0.066	0.080	0.082	0.086	0.101	0.094	0.071
N° 10 (Bias2)	0.054	0.055	0.061	0.066	0.063	0.078	0.077	0.081	0.092	0.088	0.068
N° 11 (Bias2)	0.054	0.054	0.055	0.060	0.061	0.083	0.074	0.078	0.084	0.083	0.066
N° 12 (OFF)	0.048	0.051	0.058	0.064	0.064	0.082	0.078	0.082	0.092	0.088	0.069
N° 13 (OFF)	0.047	0.049	0.060	0.068	0.064	0.077	0.079	0.083	0.093	0.089	0.069
N° 14 (OFF)	0.066	0.055	0.059	0.078	0.067	0.089	0.078	0.082	0.092	0.087	0.069
N° 15 (OFF)	0.048	0.059	0.065	0.070	0.079	0.095	0.083	0.087	0.100	0.094	0.072
N° 16 (OFF)	0.049	0.058	0.063	0.071	0.075	0.082	0.085	0.089	0.102	0.095	0.074

Delta [VOL1]

	0krad(Si)	10krad(Si)	19krad(Si)	49krad(Si)	65krad(Si)	101krad(Si)	130krad(Si)	152krad(Si)	203krad(Si)	24h/25°C	168h/100°C
N° 1 (Ref)	---	6.359E-4	1.512E-3	2.364E-3	3.920E-3	2.089E-3	1.503E-3	1.520E-3	-3.282E-4	-7.130E-4	-8.969E-4
N° 2 (Bias1)	---	4.317E-3	7.022E-3	7.640E-3	1.478E-2	1.889E-2	1.848E-2	2.029E-2	2.141E-2	2.023E-2	7.632E-3
N° 3 (Bias1)	---	1.104E-2	1.427E-2	5.678E-3	1.052E-2	1.254E-2	1.430E-2	1.596E-2	1.697E-2	1.584E-2	4.868E-3
N° 4 (Bias1)	---	-1.637E-3	-6.153E-3	-1.338E-4	2.314E-3	4.358E-3	5.903E-3	7.723E-3	8.953E-3	8.113E-3	-4.911E-3
N° 5 (Bias1)	---	3.550E-3	8.971E-3	7.862E-3	1.254E-2	1.262E-2	1.263E-2	1.424E-2	1.549E-2	1.451E-2	2.173E-3
N° 6 (Bias1)	---	-8.704E-4	8.783E-3	6.111E-3	1.072E-2	1.417E-2	1.361E-2	1.519E-2	1.614E-2	1.490E-2	4.347E-3
N° 7 (Bias2)	---	1.609E-4	1.018E-2	1.041E-2	1.122E-2	2.149E-2	2.426E-2	2.707E-2	3.469E-2	3.171E-2	1.550E-2
N° 8 (Bias2)	---	2.578E-4	4.440E-3	1.727E-2	1.243E-2	2.798E-2	2.928E-2	3.287E-2	4.345E-2	3.957E-2	1.853E-2
N° 9 (Bias2)	---	1.266E-3	2.771E-3	1.807E-2	1.244E-2	2.609E-2	2.884E-2	3.278E-2	4.730E-2	3.992E-2	1.786E-2
N° 10 (Bias2)	---	1.355E-3	6.848E-3	1.269E-2	9.449E-3	2.460E-2	2.374E-2	2.759E-2	3.801E-2	3.387E-2	1.471E-2
N° 11 (Bias2)	---	-3.108E-4	1.123E-3	5.548E-3	6.691E-3	2.826E-2	2.024E-2	2.352E-2	3.002E-2	2.877E-2	1.136E-2
N° 12 (OFF)	---	3.807E-3	1.021E-2	1.687E-2	1.626E-2	3.452E-2	3.078E-2	3.405E-2	4.423E-2	4.008E-2	2.114E-2
N° 13 (OFF)	---	2.386E-3	1.374E-2	2.152E-2	1.780E-2	3.035E-2	3.238E-2	3.604E-2	4.645E-2	4.192E-2	2.247E-2
N° 14 (OFF)	---	-1.083E-2	-7.098E-3	1.220E-2	1.036E-3	2.247E-2	1.190E-2	1.534E-2	2.538E-2	2.081E-2	2.245E-3
N° 15 (OFF)	---	1.041E-2	1.682E-2	2.128E-2	3.067E-2	4.665E-2	3.501E-2	3.880E-2	5.159E-2	4.598E-2	2.395E-2
N° 16 (OFF)	---	9.491E-3	1.472E-2	2.215E-2	2.594E-2	3.364E-2	3.660E-2	4.041E-2	5.298E-2	4.653E-2	2.488E-2
Average (Bias1)	---	3.279E-3	6.579E-3	5.432E-3	1.017E-2	1.252E-2	1.299E-2	1.468E-2	1.579E-2	1.472E-2	2.822E-3
σ (Bias1)	---	5.068E-3	7.617E-3	3.251E-3	4.717E-3	5.242E-3	4.544E-3	4.526E-3	4.469E-3	4.341E-3	4.740E-3
Average+3σ (Bias1)	---	1.848E-2	2.943E-2	1.518E-2	2.432E-2	2.824E-2	2.662E-2	2.826E-2	2.920E-2	2.774E-2	1.704E-2
Average-3σ (Bias1)	---	-1.192E-2	-1.627E-2	-4.322E-3	-3.976E-3	-3.209E-3	-6.459E-4	1.099E-3	2.385E-3	1.697E-3	-1.140E-2
Average (Bias2)	---	5.458E-4	5.073E-3	1.280E-2	1.045E-2	2.569E-2	2.527E-2	2.876E-2	3.870E-2	3.477E-2	1.559E-2
σ (Bias2)	---	7.312E-4	3.555E-3	5.150E-3	2.428E-3	2.778E-3	3.791E-3	4.023E-3	6.864E-3	4.893E-3	2.849E-3
Average+3σ (Bias2)	---	2.739E-3	1.574E-2	2.825E-2	1.773E-2	3.402E-2	3.664E-2	4.083E-2	5.929E-2	4.945E-2	2.414E-2
Average-3σ (Bias2)	---	-1.648E-3	-5.593E-3	-2.651E-3	3.160E-3	1.735E-2	1.390E-2	1.670E-2	1.810E-2	2.009E-2	7.044E-3
Average (OFF)	---	3.053E-3	9.680E-3	1.881E-2	1.834E-2	3.353E-2	2.933E-2	3.293E-2	4.413E-2	3.906E-2	1.894E-2
σ (OFF)	---	8.503E-3	9.678E-3	4.245E-3	1.133E-2	8.739E-3	1.000E-2	1.013E-2	1.108E-2	1.056E-2	9.439E-3
Average+3σ (OFF)	---	2.856E-2	3.871E-2	3.154E-2	5.235E-2	5.974E-2	5.934E-2	6.333E-2	7.736E-2	7.074E-2	4.726E-2
Average-3σ (OFF)	---	-2.246E-2	-1.936E-2	6.071E-3	-1.566E-2	7.309E-3	-6.715E-4	2.525E-3	1.089E-2	7.386E-3	-9.381E-3

2. VOL2

Ta=25°C; If = 1.6 mA; Iol = 4.8 mA; Vcc = 4.5 V

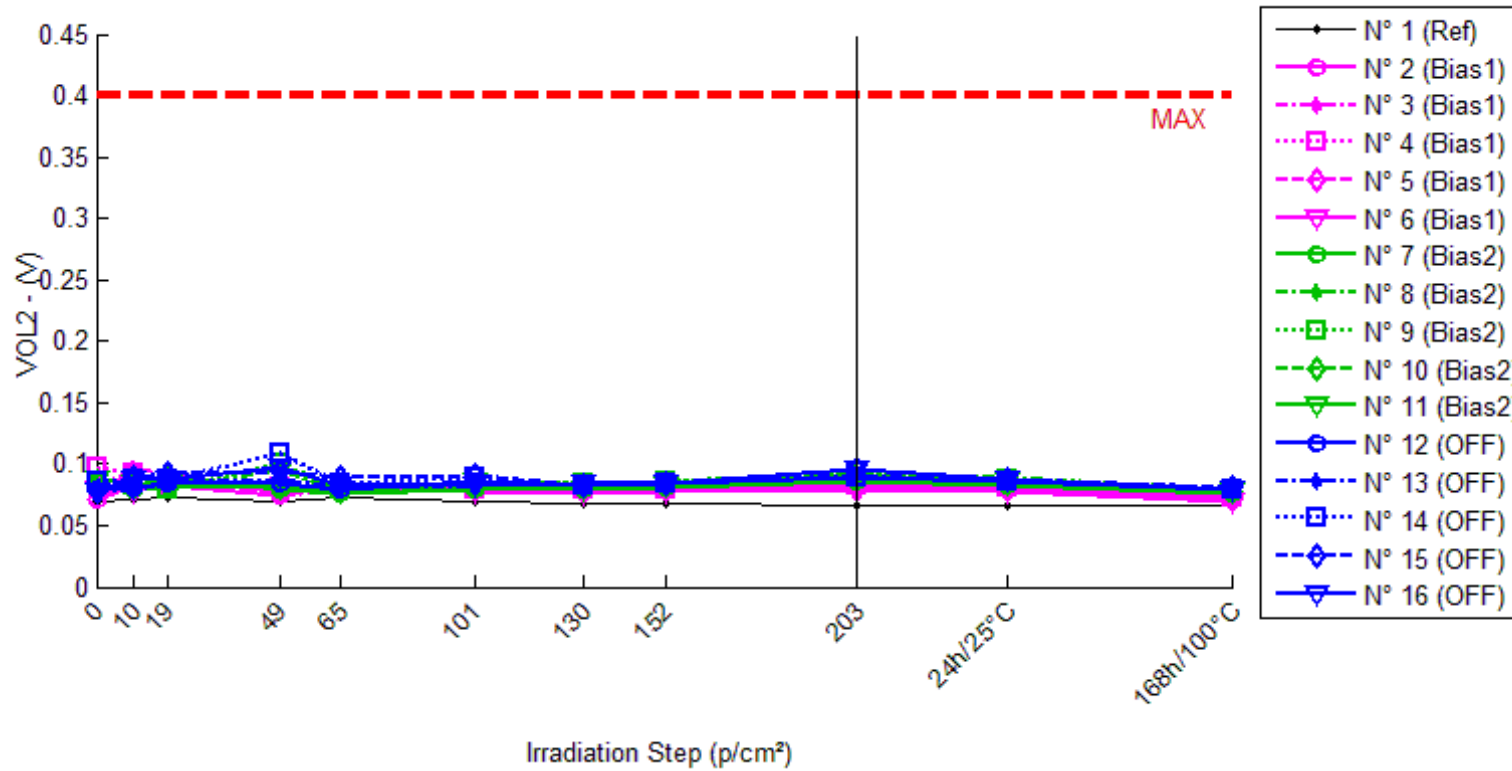

VOL2 . (V)

Max = 0.4

	0krad(Si)	10krad(Si)	19krad(Si)	49krad(Si)	65krad(Si)	101krad(Si)	130krad(Si)	152krad(Si)	203krad(Si)	24h/25°C	168h/100°C
N° 1 (Ref)	0.069	0.071	0.073	0.070	0.073	0.069	0.068	0.068	0.067	0.067	0.066
N° 2 (Bias1)	0.072	0.083	0.082	0.075	0.082	0.081	0.080	0.081	0.082	0.081	0.074
N° 3 (Bias1)	0.081	0.095	0.092	0.074	0.079	0.077	0.077	0.078	0.079	0.078	0.072
N° 4 (Bias1)	0.097	0.092	0.082	0.081	0.080	0.079	0.079	0.080	0.082	0.081	0.073
N° 5 (Bias1)	0.085	0.088	0.090	0.081	0.083	0.079	0.078	0.079	0.081	0.079	0.072
N° 6 (Bias1)	0.080	0.078	0.087	0.077	0.077	0.077	0.076	0.077	0.078	0.077	0.070
N° 7 (Bias2)	0.080	0.079	0.091	0.079	0.076	0.079	0.080	0.081	0.086	0.083	0.076
N° 8 (Bias2)	0.083	0.080	0.080	0.095	0.078	0.085	0.085	0.086	0.092	0.089	0.080
N° 9 (Bias2)	0.084	0.083	0.079	0.100	0.079	0.084	0.084	0.086	0.094	0.088	0.079
N° 10 (Bias2)	0.086	0.085	0.088	0.083	0.078	0.083	0.082	0.083	0.089	0.085	0.077
N° 11 (Bias2)	0.088	0.085	0.083	0.081	0.077	0.086	0.080	0.082	0.087	0.086	0.077
N° 12 (OFF)	0.079	0.081	0.084	0.085	0.080	0.086	0.082	0.084	0.090	0.086	0.079
N° 13 (OFF)	0.078	0.078	0.086	0.088	0.081	0.083	0.083	0.084	0.091	0.086	0.080
N° 14 (OFF)	0.086	0.087	0.087	0.109	0.084	0.090	0.082	0.084	0.090	0.086	0.079
N° 15 (OFF)	0.078	0.089	0.093	0.094	0.090	0.091	0.083	0.085	0.095	0.087	0.081
N° 16 (OFF)	0.078	0.087	0.087	0.098	0.082	0.083	0.084	0.085	0.096	0.087	0.080

Delta [VOL2]

	0krad(Si)	10krad(Si)	19krad(Si)	49krad(Si)	65krad(Si)	101krad(Si)	130krad(Si)	152krad(Si)	203krad(Si)	24h/25°C	168h/100°C
N° 1 (Ref)	---	2.061E-3	3.516E-3	1.158E-3	3.684E-3	-6.854E-5	-7.600E-4	-7.235E-4	-1.944E-3	-2.227E-3	-2.752E-3
N° 2 (Bias1)	---	1.065E-2	9.635E-3	3.253E-3	1.017E-2	8.936E-3	7.700E-3	8.783E-3	9.924E-3	8.785E-3	1.998E-3
N° 3 (Bias1)	---	1.406E-2	1.104E-2	-7.379E-3	-2.647E-3	-4.802E-3	-4.360E-3	-3.361E-3	-2.299E-3	-3.363E-3	-9.486E-3
N° 4 (Bias1)	---	-4.899E-3	-1.550E-2	-1.635E-2	-1.732E-2	-1.802E-2	-1.789E-2	-1.690E-2	-1.527E-2	-1.647E-2	-2.369E-2
N° 5 (Bias1)	---	3.308E-3	5.487E-3	-3.754E-3	-1.558E-3	-5.749E-3	-6.643E-3	-5.685E-3	-3.978E-3	-5.438E-3	-1.246E-2
N° 6 (Bias1)	---	-2.343E-3	6.357E-3	-2.815E-3	-3.477E-3	-2.981E-3	-4.348E-3	-3.398E-3	-1.839E-3	-3.512E-3	-9.773E-3
N° 7 (Bias2)	---	-1.708E-3	1.076E-2	-9.193E-4	-4.315E-3	-1.332E-3	-4.405E-4	9.193E-4	5.308E-3	2.750E-3	-4.745E-3
N° 8 (Bias2)	---	-2.113E-3	-2.189E-3	1.236E-2	-5.026E-3	2.543E-3	2.117E-3	3.632E-3	9.899E-3	6.208E-3	-2.791E-3
N° 9 (Bias2)	---	-1.092E-3	-4.240E-3	1.682E-2	-4.467E-3	1.823E-4	4.679E-4	2.122E-3	1.034E-2	4.718E-3	-4.277E-3
N° 10 (Bias2)	---	-6.729E-4	2.379E-3	-2.350E-3	-7.476E-3	-2.295E-3	-4.083E-3	-2.353E-3	3.860E-3	-3.195E-4	-8.297E-3
N° 11 (Bias2)	---	-3.253E-3	-5.475E-3	-6.628E-3	-1.116E-2	-1.630E-3	-7.837E-3	-6.272E-3	-1.468E-3	-1.796E-3	-1.132E-2
N° 12 (OFF)	---	2.583E-3	5.343E-3	6.125E-3	1.486E-3	7.235E-3	3.769E-3	5.231E-3	1.165E-2	7.462E-3	5.649E-4
N° 13 (OFF)	---	6.278E-4	8.558E-3	1.001E-2	3.528E-3	4.929E-3	4.931E-3	6.457E-3	1.309E-2	8.668E-3	2.198E-3
N° 14 (OFF)	---	1.515E-3	6.771E-4	2.346E-2	-1.939E-3	4.155E-3	-3.672E-3	-2.202E-3	4.331E-3	-1.722E-4	-6.723E-3
N° 15 (OFF)	---	1.192E-2	1.506E-2	1.640E-2	1.254E-2	1.340E-2	5.808E-3	7.161E-3	1.704E-2	9.669E-3	3.517E-3
N° 16 (OFF)	---	9.713E-3	9.485E-3	2.003E-2	4.855E-3	5.858E-3	6.329E-3	7.692E-3	1.819E-2	9.802E-3	2.836E-3
Average (Bias1)	---	4.157E-3	3.402E-3	-5.409E-3	-2.966E-3	-4.524E-3	-5.108E-3	-4.112E-3	-2.692E-3	-3.999E-3	-1.068E-2
σ (Bias1)	---	8.144E-3	1.081E-2	7.212E-3	9.759E-3	9.583E-3	9.095E-3	9.129E-3	8.942E-3	8.966E-3	9.157E-3
Average+3σ (Bias1)	---	2.859E-2	3.584E-2	1.623E-2	2.631E-2	2.423E-2	2.218E-2	2.327E-2	2.413E-2	2.290E-2	1.679E-2
Average-3σ (Bias1)	---	-2.028E-2	-2.903E-2	-2.705E-2	-3.224E-2	-3.327E-2	-3.239E-2	-3.150E-2	-2.952E-2	-3.090E-2	-3.815E-2
Average (Bias2)	---	-1.768E-3	2.467E-4	3.855E-3	-6.489E-3	-5.061E-4	-1.955E-3	-3.905E-4	5.588E-3	2.312E-3	-6.285E-3
σ (Bias2)	---	9.981E-4	6.592E-3	1.014E-2	2.904E-3	1.931E-3	3.996E-3	3.958E-3	4.848E-3	3.353E-3	3.464E-3
Average+3σ (Bias2)	---	1.226E-3	2.002E-2	3.428E-2	2.225E-3	5.286E-3	1.003E-2	1.148E-2	2.013E-2	1.237E-2	4.106E-3
Average-3σ (Bias2)	---	-4.762E-3	-1.953E-2	-2.657E-2	-1.520E-2	-6.299E-3	-1.394E-2	-1.226E-2	-8.955E-3	-7.746E-3	-1.668E-2
Average (OFF)	---	5.272E-3	7.825E-3	1.520E-2	4.093E-3	7.114E-3	3.433E-3	4.868E-3	1.286E-2	7.086E-3	4.785E-4
σ (OFF)	---	5.169E-3	5.312E-3	7.111E-3	5.371E-3	3.694E-3	4.088E-3	4.058E-3	5.481E-3	4.165E-3	4.172E-3
Average+3σ (OFF)	---	2.078E-2	2.376E-2	3.654E-2	2.021E-2	1.820E-2	1.570E-2	1.704E-2	2.930E-2	1.958E-2	1.299E-2
Average-3σ (OFF)	---	-1.023E-2	-8.112E-3	-6.130E-3	-1.202E-2	-3.968E-3	-8.832E-3	-7.307E-3	-3.583E-3	-5.408E-3	-1.204E-2

3. VOL3

Ta=25°C; If = 5 mA; Iol = 10 mA; Vcc = 4.5 V

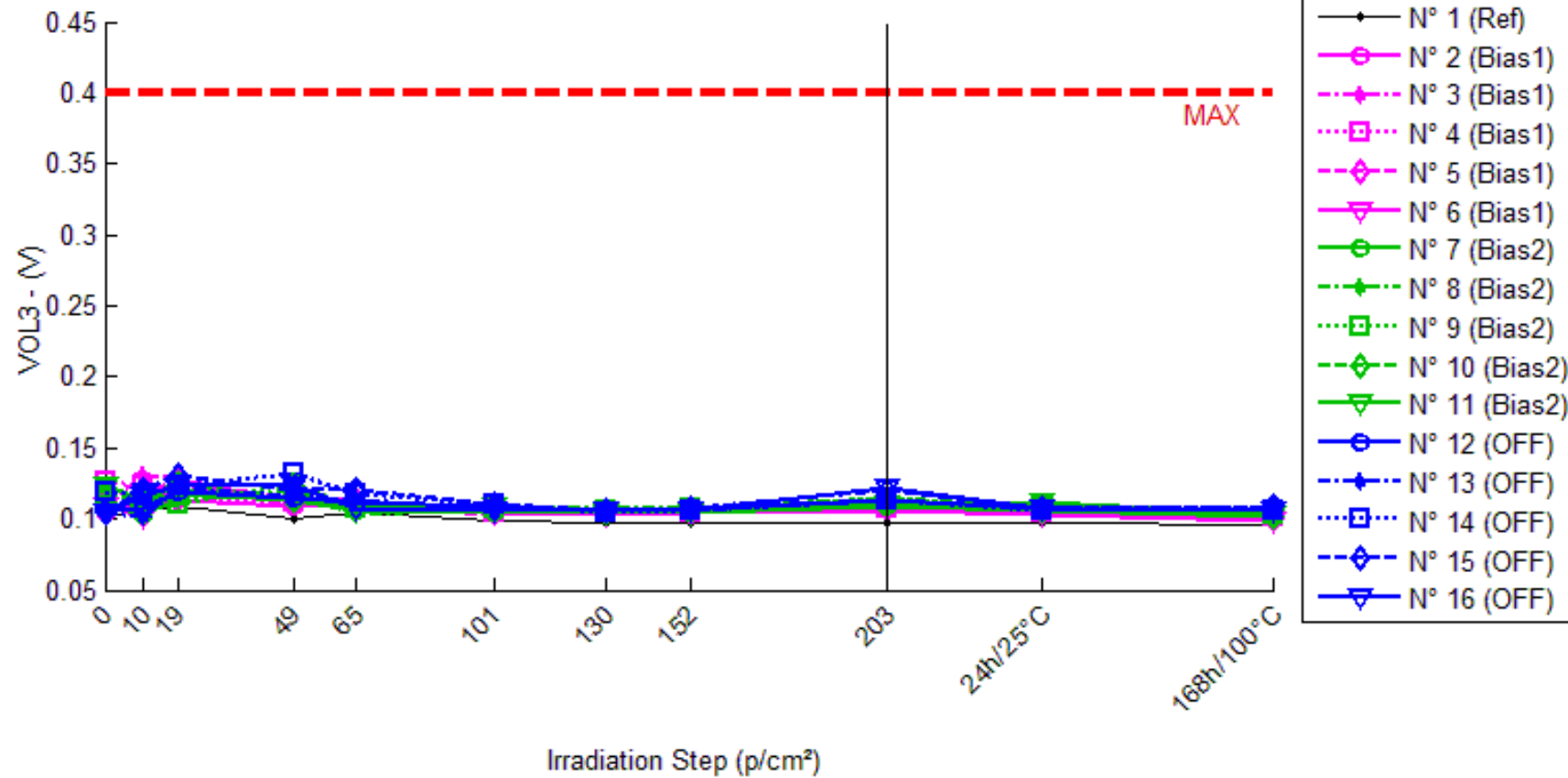

VOL3 . (V)

Max = 0.4

	0krad(Si)	10krad(Si)	19krad(Si)	49krad(Si)	65krad(Si)	101krad(Si)	130krad(Si)	152krad(Si)	203krad(Si)	24h/25°C	168h/100°C
N° 1 (Ref)	0.102	0.106	0.109	0.100	0.105	0.099	0.098	0.098	0.097	0.097	0.096
N° 2 (Bias1)	0.105	0.111	0.113	0.109	0.112	0.106	0.105	0.106	0.107	0.105	0.101
N° 3 (Bias1)	0.111	0.131	0.130	0.109	0.109	0.103	0.103	0.104	0.105	0.104	0.100
N° 4 (Bias1)	0.127	0.124	0.115	0.112	0.107	0.105	0.105	0.105	0.108	0.105	0.101
N° 5 (Bias1)	0.116	0.118	0.128	0.113	0.113	0.105	0.104	0.105	0.107	0.104	0.100
N° 6 (Bias1)	0.109	0.102	0.125	0.113	0.106	0.105	0.103	0.104	0.106	0.103	0.099
N° 7 (Bias2)	0.110	0.103	0.120	0.113	0.106	0.104	0.104	0.105	0.109	0.106	0.101
N° 8 (Bias2)	0.112	0.105	0.113	0.121	0.103	0.108	0.107	0.108	0.115	0.109	0.104
N° 9 (Bias2)	0.114	0.108	0.111	0.125	0.107	0.107	0.106	0.107	0.115	0.108	0.103
N° 10 (Bias2)	0.118	0.113	0.125	0.113	0.108	0.107	0.105	0.106	0.113	0.106	0.102
N° 11 (Bias2)	0.123	0.113	0.118	0.114	0.107	0.109	0.104	0.105	0.111	0.112	0.103
N° 12 (OFF)	0.106	0.107	0.119	0.115	0.112	0.109	0.106	0.107	0.114	0.107	0.106
N° 13 (OFF)	0.105	0.102	0.122	0.116	0.114	0.107	0.106	0.106	0.114	0.107	0.107
N° 14 (OFF)	0.119	0.117	0.124	0.132	0.117	0.111	0.105	0.106	0.114	0.106	0.106
N° 15 (OFF)	0.104	0.120	0.131	0.121	0.120	0.111	0.106	0.107	0.121	0.107	0.109
N° 16 (OFF)	0.104	0.116	0.123	0.124	0.107	0.106	0.106	0.106	0.122	0.107	0.106

Delta [VOL3]

	0krad(Si)	10krad(Si)	19krad(Si)	49krad(Si)	65krad(Si)	101krad(Si)	130krad(Si)	152krad(Si)	203krad(Si)	24h/25°C	168h/100°C
N° 1 (Ref)	---	4.315E-3	6.818E-3	-1.593E-3	2.570E-3	-3.145E-3	-3.883E-3	-3.774E-3	-4.791E-3	-5.180E-3	-6.085E-3
N° 2 (Bias1)	---	5.300E-3	7.870E-3	3.933E-3	6.837E-3	9.633E-4	-2.274E-4	5.757E-4	1.711E-3	-1.302E-5	-4.408E-3
N° 3 (Bias1)	---	2.014E-2	1.927E-2	-1.688E-3	-1.605E-3	-7.480E-3	-7.646E-3	-6.903E-3	-5.841E-3	-7.295E-3	-1.126E-2
N° 4 (Bias1)	---	-2.914E-3	-1.189E-2	-1.536E-2	-2.051E-2	-2.207E-2	-2.254E-2	-2.184E-2	-1.971E-2	-2.185E-2	-2.674E-2
N° 5 (Bias1)	---	1.865E-3	1.172E-2	-3.593E-3	-3.062E-3	-1.114E-2	-1.212E-2	-1.141E-2	-8.938E-3	-1.163E-2	-1.635E-2
N° 6 (Bias1)	---	-6.998E-3	1.515E-2	3.193E-3	-3.902E-3	-4.852E-3	-6.405E-3	-5.662E-3	-3.285E-3	-6.134E-3	-1.048E-2
N° 7 (Bias2)	---	-6.188E-3	1.094E-2	3.324E-3	-3.509E-3	-5.097E-3	-5.051E-3	-4.167E-3	-1.309E-5	-3.771E-3	-8.092E-3
N° 8 (Bias2)	---	-6.899E-3	9.218E-4	8.965E-3	-8.698E-3	-3.697E-3	-4.681E-3	-3.803E-3	2.936E-3	-3.074E-3	-7.956E-3
N° 9 (Bias2)	---	-5.541E-3	-2.356E-3	1.102E-2	-6.902E-3	-6.736E-3	-7.358E-3	-6.352E-3	1.722E-3	-5.704E-3	-1.052E-2
N° 10 (Bias2)	---	-5.070E-3	7.532E-3	-4.887E-3	-1.031E-2	-1.126E-2	-1.309E-2	-1.204E-2	-4.786E-3	-1.184E-2	-1.610E-2
N° 11 (Bias2)	---	-9.843E-3	-4.736E-3	-8.479E-3	-1.574E-2	-1.395E-2	-1.862E-2	-1.759E-2	-1.143E-2	-1.114E-2	-1.992E-2
N° 12 (OFF)	---	6.077E-4	1.295E-2	8.610E-3	5.553E-3	2.661E-3	-3.014E-4	5.062E-4	7.770E-3	1.041E-3	-3.919E-4
N° 13 (OFF)	---	-2.655E-3	1.751E-2	1.077E-2	9.012E-3	1.698E-3	8.638E-4	1.680E-3	9.367E-3	2.156E-3	2.089E-3
N° 14 (OFF)	---	-2.357E-3	4.259E-3	1.243E-2	-2.808E-3	-8.037E-3	-1.404E-2	-1.319E-2	-5.603E-3	-1.302E-2	-1.366E-2
N° 15 (OFF)	---	1.596E-2	2.674E-2	1.662E-2	1.575E-2	6.970E-3	1.784E-3	2.242E-3	1.649E-2	2.897E-3	4.244E-3
N° 16 (OFF)	---	1.208E-2	1.921E-2	1.954E-2	2.546E-3	2.082E-3	1.584E-3	2.207E-3	1.795E-2	2.436E-3	1.918E-3
Average (Bias1)	---	3.479E-3	8.423E-3	-2.703E-3	-4.449E-3	-8.916E-3	-9.786E-3	-9.048E-3	-7.213E-3	-9.386E-3	-1.385E-2
σ (Bias1)	---	1.042E-2	1.211E-2	7.761E-3	9.947E-3	8.574E-3	8.298E-3	8.336E-3	8.003E-3	8.114E-3	8.361E-3
Average+3σ (Bias1)	---	3.474E-2	4.476E-2	2.058E-2	2.539E-2	1.681E-2	1.511E-2	1.596E-2	1.680E-2	1.495E-2	1.123E-2
Average-3σ (Bias1)	---	-2.778E-2	-2.791E-2	-2.599E-2	-3.429E-2	-3.464E-2	-3.468E-2	-3.406E-2	-3.122E-2	-3.373E-2	-3.893E-2
Average (Bias2)	---	-6.708E-3	2.461E-3	1.988E-3	-9.033E-3	-8.149E-3	-9.760E-3	-8.791E-3	-2.314E-3	-7.105E-3	-1.252E-2
σ (Bias2)	---	1.883E-3	6.615E-3	8.498E-3	4.523E-3	4.316E-3	5.986E-3	5.921E-3	5.880E-3	4.123E-3	5.291E-3
Average+3σ (Bias2)	---	-1.059E-3	2.231E-2	2.748E-2	4.535E-3	4.800E-3	8.198E-3	8.973E-3	1.533E-2	5.265E-3	3.356E-3
Average-3σ (Bias2)	---	-1.236E-2	-1.738E-2	-2.351E-2	-2.260E-2	-2.110E-2	-2.772E-2	-2.655E-2	-1.995E-2	-1.947E-2	-2.839E-2
Average (OFF)	---	4.728E-3	1.613E-2	1.360E-2	6.010E-3	1.075E-3	-2.021E-3	-1.311E-3	9.195E-3	-8.979E-4	-1.160E-3
σ (OFF)	---	8.688E-3	8.292E-3	4.437E-3	6.960E-3	5.516E-3	6.766E-3	6.678E-3	9.366E-3	6.810E-3	7.178E-3
Average+3σ (OFF)	---	3.079E-2	4.101E-2	2.690E-2	2.689E-2	1.762E-2	1.828E-2	1.872E-2	3.729E-2	1.953E-2	2.037E-2
Average-3σ (OFF)	---	-2.134E-2	-8.742E-3	2.852E-4	-1.487E-2	-1.547E-2	-2.232E-2	-2.134E-2	-1.890E-2	-2.133E-2	-2.269E-2

4. IOH

Ta=25°C; If = 2 µA; Vo = Vcc = 18 V

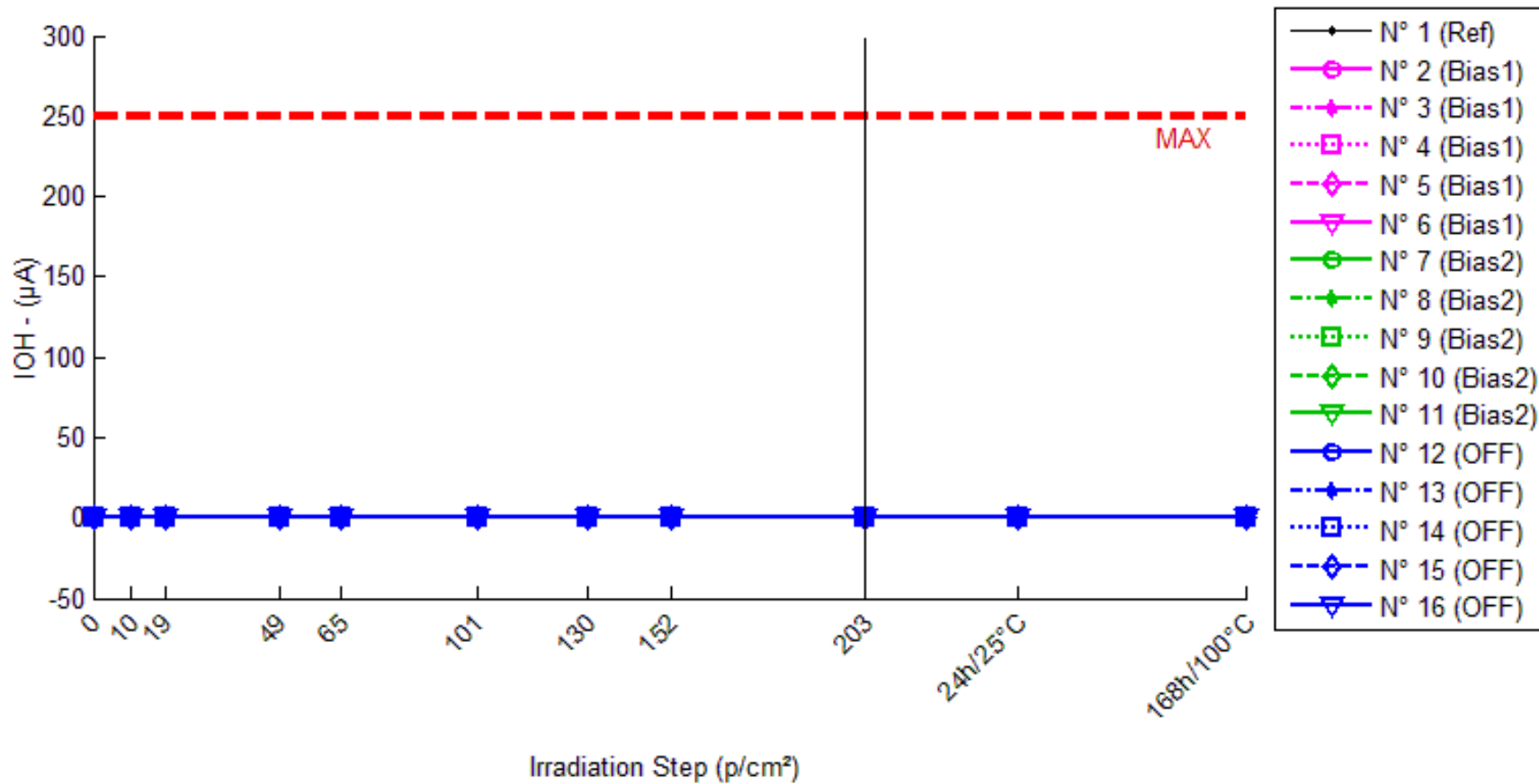

IOH . (µA)

Max = 250.0

	0krad(Si)	10krad(Si)	19krad(Si)	49krad(Si)	65krad(Si)	101krad(Si)	130krad(Si)	152krad(Si)	203krad(Si)	24h/25°C	168h/100°C
N° 1 (Ref)	0.000	0.000	0.000	0.000	0.000	0.000	0.000	0.000	0.000	0.000	0.000
N° 2 (Bias1)	0.000	0.000	0.000	0.000	0.000	0.000	0.000	0.000	0.000	0.000	0.000
N° 3 (Bias1)	0.000	0.000	0.000	0.000	0.000	0.012	0.000	0.001	0.000	0.000	0.000
N° 4 (Bias1)	0.000	0.000	0.000	0.000	0.000	0.010	0.000	0.001	0.000	0.000	0.000
N° 5 (Bias1)	0.000	0.000	0.000	0.000	0.000	0.006	0.000	0.001	0.000	0.000	0.000
N° 6 (Bias1)	0.000	0.000	0.000	0.000	0.000	0.005	0.001	0.001	0.000	0.000	0.000
N° 7 (Bias2)	0.000	0.000	0.000	0.000	0.000	0.004	0.000	0.001	0.000	0.000	0.000
N° 8 (Bias2)	0.000	0.000	0.000	0.000	0.000	0.003	0.000	0.001	0.000	0.000	0.000
N° 9 (Bias2)	0.000	0.000	0.000	0.000	0.000	0.003	0.000	0.001	0.000	0.000	0.000
N° 10 (Bias2)	0.000	0.000	0.000	0.000	0.000	0.002	0.000	0.001	0.000	0.000	0.000
N° 11 (Bias2)	0.000	0.000	0.000	0.000	0.000	0.002	0.001	0.001	0.000	0.000	0.000
N° 12 (OFF)	0.000	0.000	0.000	0.000	0.000	0.002	0.001	0.001	0.000	0.000	0.000
N° 13 (OFF)	0.000	0.000	0.000	0.000	0.000	0.002	0.001	0.001	0.000	0.000	0.000
N° 14 (OFF)	0.000	0.000	0.000	0.000	0.000	0.002	0.001	0.001	0.000	0.000	0.000
N° 15 (OFF)	0.020	0.000	0.000	0.000	0.000	0.002	0.001	0.001	0.000	0.000	0.000
N° 16 (OFF)	0.000	0.000	0.000	0.000	0.000	0.002	0.001	0.001	0.000	0.000	0.000

Delta [IOH]

	0krad(Si)	10krad(Si)	19krad(Si)	49krad(Si)	65krad(Si)	101krad(Si)	130krad(Si)	152krad(Si)	203krad(Si)	24h/25°C	168h/100°C
N° 1 (Ref)	---	1.153E-4	-4.142E-5	-2.616E-5	-5.267E-5	1.737E-4	1.084E-4	9.943E-5	-9.643E-5	-1.057E-4	1.526E-4
N° 2 (Bias1)	---	1.101E-4	-4.356E-5	-1.350E-5	-2.711E-5	1.956E-4	1.849E-4	2.014E-4	-4.009E-5	-5.286E-5	6.673E-5
N° 3 (Bias1)	---	3.415E-5	-1.188E-4	-1.008E-4	-1.047E-4	1.179E-2	1.134E-4	1.623E-4	-1.169E-4	-1.366E-4	-1.030E-4
N° 4 (Bias1)	---	1.138E-4	-1.820E-6	-1.298E-5	-2.508E-5	1.011E-2	2.064E-4	2.526E-4	-3.865E-5	-5.248E-5	-4.673E-5
N° 5 (Bias1)	---	9.433E-5	-4.567E-5	-4.056E-5	-5.164E-5	6.046E-3	1.579E-4	2.216E-4	-6.183E-5	-7.828E-5	-8.673E-5
N° 6 (Bias1)	---	1.206E-4	-2.292E-5	-1.180E-5	-2.466E-5	4.623E-3	2.274E-4	2.388E-4	-3.979E-5	-5.349E-5	-6.114E-5
N° 7 (Bias2)	---	1.187E-4	-2.774E-5	-1.450E-5	-2.457E-5	3.796E-3	2.021E-4	2.580E-4	-2.672E-5	-3.716E-5	-6.993E-5
N° 8 (Bias2)	---	1.311E-4	-8.815E-6	2.051E-6	-1.178E-5	2.701E-3	1.959E-4	2.957E-4	-1.924E-6	-2.319E-5	-5.770E-5
N° 9 (Bias2)	---	1.096E-4	-3.229E-5	-1.749E-5	-3.233E-5	2.682E-3	2.089E-4	2.873E-4	-2.578E-5	-4.645E-5	-8.100E-5
N° 10 (Bias2)	---	1.277E-4	-1.228E-5	1.338E-6	-1.655E-5	2.213E-3	2.041E-4	2.867E-4	-5.935E-6	-2.610E-5	-6.099E-5
N° 11 (Bias2)	---	1.264E-4	-1.777E-5	5.360E-6	-1.532E-5	2.097E-3	2.308E-4	3.048E-4	-2.090E-5	-2.927E-5	-5.608E-5
N° 12 (OFF)	---	1.323E-4	-1.325E-5	2.825E-7	-1.646E-5	1.869E-3	2.365E-4	3.294E-4	-2.217E-5	-3.160E-5	-4.534E-5
N° 13 (OFF)	---	7.027E-5	-7.658E-5	-6.077E-5	-7.853E-5	1.667E-3	1.818E-4	2.788E-4	-8.149E-5	-9.345E-5	-1.203E-4
N° 14 (OFF)	---	1.410E-4	3.233E-6	9.492E-7	-8.142E-6	1.660E-3	2.544E-4	3.670E-4	-8.819E-6	-2.066E-5	-5.334E-5
N° 15 (OFF)	---	-1.947E-2	-1.962E-2	-1.961E-2	-1.962E-2	-1.809E-2	-1.936E-2	-1.924E-2	-1.962E-2	-1.964E-2	-1.966E-2
N° 16 (OFF)	---	1.479E-4	-1.765E-6	1.084E-5	5.718E-6	1.522E-3	2.618E-4	3.546E-4	4.577E-6	-1.695E-5	-5.268E-5
Average (Bias1)	---	9.461E-5	-4.654E-5	-3.592E-5	-4.663E-5	6.554E-3	1.780E-4	2.153E-4	-5.945E-5	-7.474E-5	-4.618E-5
σ (Bias1)	---	3.515E-5	4.411E-5	3.821E-5	3.436E-5	4.596E-3	4.436E-5	3.531E-5	3.354E-5	3.628E-5	6.680E-5
Average+3σ (Bias1)	---	2.001E-4	8.578E-5	7.870E-5	5.645E-5	2.034E-2	3.111E-4	3.213E-4	4.116E-5	3.409E-5	1.542E-4
Average-3σ (Bias1)	---	-1.084E-5	-1.789E-4	-1.505E-4	-1.497E-4	-7.236E-3	4.490E-5	1.094E-4	-1.601E-4	-1.836E-4	-2.466E-4
Average (Bias2)	---	1.227E-4	-1.978E-5	-4.648E-6	-2.011E-5	2.698E-3	2.084E-4	2.865E-4	-1.625E-5	-3.244E-5	-6.514E-5
σ (Bias2)	---	8.615E-6	1.000E-5	1.052E-5	8.281E-6	6.712E-4	1.337E-5	1.755E-5	1.155E-5	9.413E-6	1.036E-5
Average+3σ (Bias2)	---	1.486E-4	1.023E-5	2.692E-5	4.736E-6	4.711E-3	2.485E-4	3.391E-4	1.840E-5	-4.197E-6	-3.406E-5
Average-3σ (Bias2)	---	9.688E-5	-4.979E-5	-3.621E-5	-4.495E-5	6.843E-4	1.683E-4	2.338E-4	-5.090E-5	-6.068E-5	-9.622E-5
Average (OFF)	---	-3.796E-3	-3.941E-3	-3.932E-3	-3.944E-3	-2.275E-3	-3.684E-3	-3.582E-3	-3.946E-3	-3.960E-3	-3.987E-3
σ (OFF)	---	8.762E-3	8.764E-3	8.765E-3	8.764E-3	8.844E-3	8.761E-3	8.753E-3	8.762E-3	8.764E-3	8.762E-3
Average+3σ (OFF)	---	2.249E-2	2.235E-2	2.236E-2	2.235E-2	2.426E-2	2.260E-2	2.268E-2	2.234E-2	2.233E-2	2.230E-2
Average-3σ (OFF)	---	-3.008E-2	-3.023E-2	-3.023E-2	-3.024E-2	-2.881E-2	-2.997E-2	-2.984E-2	-3.023E-2	-3.025E-2	-3.027E-2

5. ICCL

Ta=25°C; Vcc = 18 V; If = 1.6 mA

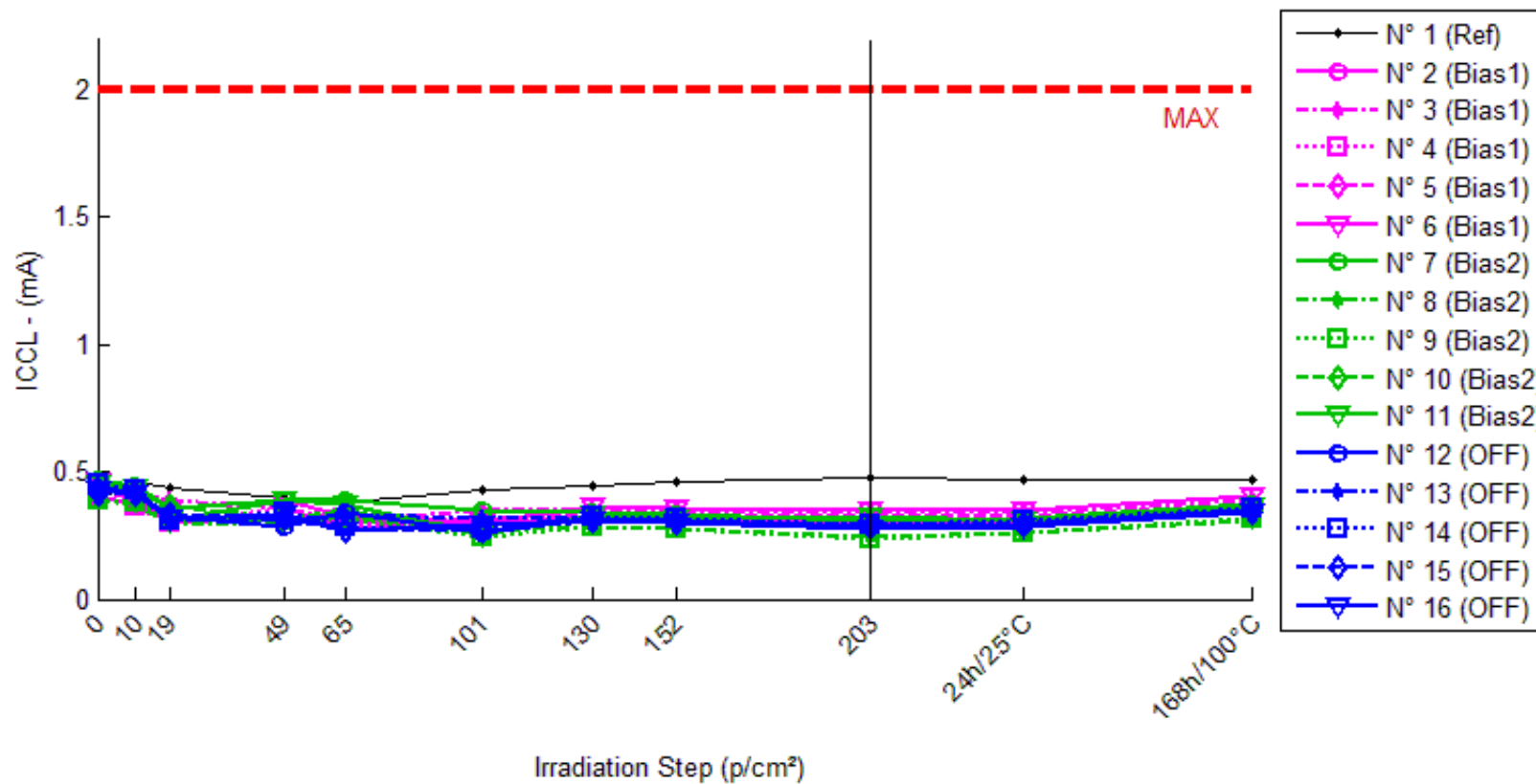

ICCL . (mA)

Max = 2.0

	0krad(Si)	10krad(Si)	19krad(Si)	49krad(Si)	65krad(Si)	101krad(Si)	130krad(Si)	152krad(Si)	203krad(Si)	24h/25°C	168h/100°C
N° 1 (Ref)	0.392	0.460	0.440	0.399	0.379	0.432	0.446	0.457	0.474	0.470	0.468
N° 2 (Bias1)	0.400	0.383	0.299	0.325	0.297	0.303	0.315	0.310	0.301	0.305	0.345
N° 3 (Bias1)	0.443	0.422	0.391	0.359	0.311	0.347	0.351	0.347	0.337	0.342	0.387
N° 4 (Bias1)	0.399	0.368	0.303	0.357	0.283	0.292	0.315	0.311	0.302	0.304	0.350
N° 5 (Bias1)	0.418	0.399	0.312	0.320	0.311	0.314	0.335	0.330	0.321	0.323	0.372
N° 6 (Bias1)	0.459	0.436	0.355	0.392	0.322	0.299	0.362	0.357	0.346	0.351	0.401
N° 7 (Bias2)	0.466	0.447	0.357	0.387	0.388	0.349	0.341	0.333	0.308	0.318	0.374
N° 8 (Bias2)	0.389	0.371	0.293	0.295	0.322	0.270	0.281	0.274	0.247	0.260	0.310
N° 9 (Bias2)	0.392	0.378	0.309	0.320	0.315	0.246	0.282	0.274	0.233	0.260	0.313
N° 10 (Bias2)	0.431	0.417	0.365	0.318	0.352	0.266	0.315	0.305	0.284	0.292	0.346
N° 11 (Bias2)	0.450	0.439	0.311	0.391	0.375	0.253	0.330	0.320	0.321	0.308	0.363
N° 12 (OFF)	0.436	0.418	0.326	0.286	0.343	0.257	0.316	0.308	0.286	0.294	0.348
N° 13 (OFF)	0.446	0.423	0.313	0.312	0.335	0.317	0.318	0.310	0.289	0.297	0.352
N° 14 (OFF)	0.456	0.432	0.311	0.337	0.283	0.326	0.326	0.318	0.296	0.305	0.360
N° 15 (OFF)	0.416	0.414	0.336	0.318	0.266	0.271	0.310	0.303	0.281	0.289	0.344
N° 16 (OFF)	0.429	0.411	0.314	0.336	0.266	0.291	0.307	0.299	0.279	0.288	0.341

Delta [ICCL]

	0krad(Si)	10krad(Si)	19krad(Si)	49krad(Si)	65krad(Si)	101krad(Si)	130krad(Si)	152krad(Si)	203krad(Si)	24h/25°C	168h/100°C
N° 1 (Ref)	---	6.859E-2	4.826E-2	7.508E-3	-1.246E-2	3.990E-2	5.412E-2	6.520E-2	8.256E-2	7.836E-2	7.622E-2
N° 2 (Bias1)	---	-1.732E-2	-1.013E-1	-7.527E-2	-1.032E-1	-9.708E-2	-8.529E-2	-9.069E-2	-9.898E-2	-9.549E-2	-5.497E-2
N° 3 (Bias1)	---	-2.136E-2	-5.204E-2	-8.423E-2	-1.316E-1	-9.640E-2	-9.180E-2	-9.622E-2	-1.061E-1	-1.014E-1	-5.588E-2
N° 4 (Bias1)	---	-3.073E-2	-9.607E-2	-4.194E-2	-1.153E-1	-1.067E-1	-8.349E-2	-8.792E-2	-9.660E-2	-9.470E-2	-4.906E-2
N° 5 (Bias1)	---	-1.852E-2	-1.054E-1	-9.758E-2	-1.067E-1	-1.034E-1	-8.278E-2	-8.741E-2	-9.682E-2	-9.429E-2	-4.604E-2
N° 6 (Bias1)	---	-2.309E-2	-1.032E-1	-6.635E-2	-1.366E-1	-1.600E-1	-9.666E-2	-1.021E-1	-1.127E-1	-1.075E-1	-5.714E-2
N° 7 (Bias2)	---	-1.956E-2	-1.092E-1	-7.971E-2	-7.814E-2	-1.172E-1	-1.253E-1	-1.333E-1	-1.582E-1	-1.486E-1	-9.218E-2
N° 8 (Bias2)	---	-1.733E-2	-9.542E-2	-9.344E-2	-6.632E-2	-1.185E-1	-1.075E-1	-1.150E-1	-1.413E-1	-1.287E-1	-7.814E-2
N° 9 (Bias2)	---	-1.327E-2	-8.238E-2	-7.140E-2	-7.624E-2	-1.455E-1	-1.092E-1	-1.173E-1	-1.586E-1	-1.318E-1	-7.892E-2
N° 10 (Bias2)	---	-1.429E-2	-6.574E-2	-1.130E-1	-7.922E-2	-1.651E-1	-1.162E-1	-1.259E-1	-1.467E-1	-1.389E-1	-8.550E-2
N° 11 (Bias2)	---	-1.085E-2	-1.386E-1	-5.912E-2	-7.494E-2	-1.968E-1	-1.199E-1	-1.296E-1	-1.292E-1	-1.421E-1	-8.685E-2
N° 12 (OFF)	---	-1.799E-2	-1.096E-1	-1.501E-1	-9.308E-2	-1.790E-1	-1.202E-1	-1.282E-1	-1.495E-1	-1.414E-1	-8.821E-2
N° 13 (OFF)	---	-2.260E-2	-1.331E-1	-1.343E-1	-1.112E-1	-1.289E-1	-1.275E-1	-1.360E-1	-1.571E-1	-1.491E-1	-9.406E-2
N° 14 (OFF)	---	-2.404E-2	-1.449E-1	-1.193E-1	-1.736E-1	-1.796E-1	-1.303E-1	-1.380E-1	-1.597E-1	-1.515E-1	-9.605E-2
N° 15 (OFF)	---	-2.525E-3	-7.997E-2	-9.886E-2	-1.504E-1	-1.457E-1	-1.063E-1	-1.137E-1	-1.356E-1	-1.273E-1	-7.255E-2
N° 16 (OFF)	---	-1.785E-2	-1.156E-1	-9.370E-2	-1.630E-1	-1.383E-1	-1.226E-1	-1.299E-1	-1.500E-1	-1.414E-1	-8.809E-2
Average (Bias1)	---	-2.220E-2	-9.160E-2	-7.307E-2	-1.187E-1	-1.127E-1	-8.800E-2	-9.286E-2	-1.022E-1	-9.868E-2	-5.262E-2
σ (Bias1)	---	5.282E-3	2.238E-2	2.088E-2	1.485E-2	2.677E-2	6.007E-3	6.220E-3	7.006E-3	5.724E-3	4.806E-3
Average+3σ (Bias1)	---	-6.357E-3	-2.445E-2	-1.042E-2	-7.414E-2	-3.240E-2	-6.998E-2	-7.420E-2	-8.122E-2	-8.151E-2	-3.820E-2
Average-3σ (Bias1)	---	-3.805E-2	-1.587E-1	-1.357E-1	-1.632E-1	-1.930E-1	-1.060E-1	-1.115E-1	-1.233E-1	-1.159E-1	-6.704E-2
Average (Bias2)	---	-1.506E-2	-9.827E-2	-8.334E-2	-7.497E-2	-1.486E-1	-1.156E-1	-1.242E-1	-1.468E-1	-1.380E-1	-8.432E-2
σ (Bias2)	---	3.425E-3	2.768E-2	2.077E-2	5.112E-3	3.355E-2	7.404E-3	7.858E-3	1.233E-2	8.001E-3	5.849E-3
Average+3σ (Bias2)	---	-4.786E-3	-1.524E-2	-2.103E-2	-5.964E-2	-4.795E-2	-9.343E-2	-1.006E-1	-1.098E-1	-1.140E-1	-6.677E-2
Average-3σ (Bias2)	---	-2.534E-2	-1.813E-1	-1.456E-1	-9.031E-2	-2.493E-1	-1.378E-1	-1.478E-1	-1.838E-1	-1.620E-1	-1.019E-1
Average (OFF)	---	-1.700E-2	-1.166E-1	-1.193E-1	-1.382E-1	-1.543E-1	-1.214E-1	-1.292E-1	-1.504E-1	-1.422E-1	-8.779E-2
σ (OFF)	---	8.546E-3	2.482E-2	2.371E-2	3.457E-2	2.361E-2	9.301E-3	9.564E-3	9.389E-3	9.467E-3	9.222E-3
Average+3σ (OFF)	---	8.636E-3	-4.217E-2	-4.814E-2	-3.454E-2	-8.346E-2	-9.349E-2	-1.005E-1	-1.222E-1	-1.137E-1	-6.013E-2
Average-3σ (OFF)	---	-4.264E-2	-1.911E-1	-1.904E-1	-2.420E-1	-2.251E-1	-1.493E-1	-1.579E-1	-1.786E-1	-1.706E-1	-1.155E-1

6. ICCH

Ta=25°C; Vcc = 18 V; If = 0

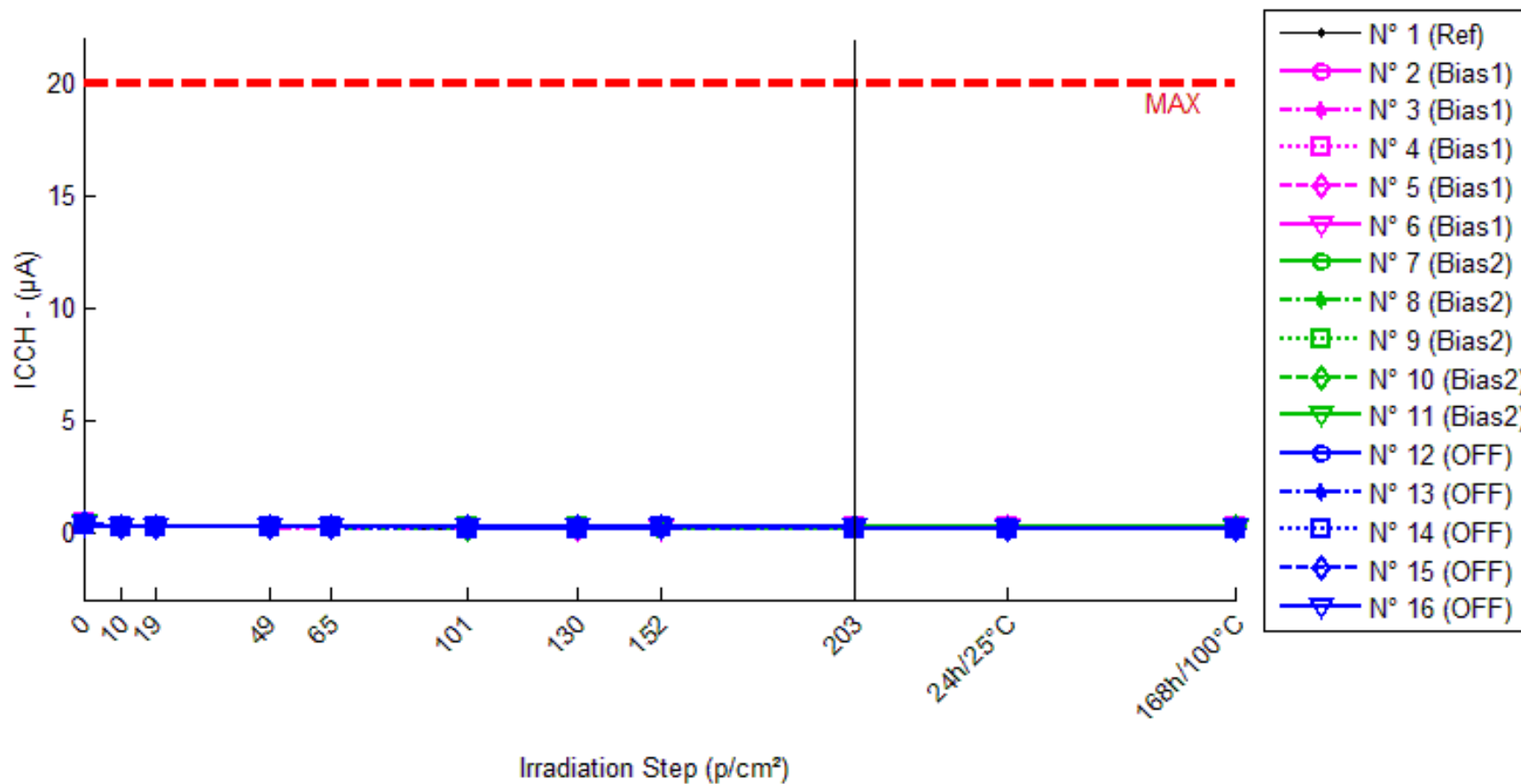

ICCH . (µA) Max = 20.0

	0krad(Si)	10krad(Si)	19krad(Si)	49krad(Si)	65krad(Si)	101krad(Si)	130krad(Si)	152krad(Si)	203krad(Si)	24h/25°C	168h/100°C
N° 1 (Ref)	0.377	0.235	0.225	0.202	0.195	0.175	0.174	0.172	0.227	0.227	0.244
N° 2 (Bias1)	0.372	0.238	0.225	0.202	0.198	0.206	0.167	0.155	0.207	0.211	0.184
N° 3 (Bias1)	0.371	0.231	0.222	0.190	0.176	0.188	0.182	0.180	0.186	0.204	0.209
N° 4 (Bias1)	0.372	0.206	0.209	0.195	0.209	0.195	0.175	0.194	0.203	0.183	0.188
N° 5 (Bias1)	0.377	0.212	0.209	0.193	0.199	0.181	0.174	0.185	0.199	0.204	0.199
N° 6 (Bias1)	0.379	0.226	0.207	0.208	0.206	0.185	0.186	0.176	0.182	0.185	0.196
N° 7 (Bias2)	0.375	0.216	0.233	0.188	0.207	0.199	0.181	0.179	0.182	0.185	0.187
N° 8 (Bias2)	0.361	0.221	0.216	0.198	0.194	0.198	0.161	0.198	0.195	0.165	0.175
N° 9 (Bias2)	0.358	0.219	0.212	0.195	0.217	0.189	0.192	0.198	0.152	0.180	0.168
N° 10 (Bias2)	0.380	0.221	0.211	0.206	0.195	0.177	0.193	0.210	0.184	0.181	0.183
N° 11 (Bias2)	0.391	0.209	0.218	0.207	0.211	0.184	0.182	0.199	0.219	0.180	0.157
N° 12 (OFF)	0.374	0.208	0.213	0.203	0.191	0.192	0.172	0.200	0.216	0.167	0.155
N° 13 (OFF)	0.387	0.230	0.215	0.197	0.205	0.189	0.179	0.181	0.227	0.159	0.177
N° 14 (OFF)	0.341	0.206	0.220	0.209	0.202	0.180	0.175	0.193	0.176	0.165	0.158
N° 15 (OFF)	0.382	0.210	0.204	0.212	0.207	0.198	0.182	0.188	0.201	0.163	0.158
N° 16 (OFF)	0.338	0.205	0.205	0.203	0.210	0.214	0.184	0.204	0.201	0.179	0.195

Delta [ICCH]

	0krad(Si)	10krad(Si)	19krad(Si)	49krad(Si)	65krad(Si)	101krad(Si)	130krad(Si)	152krad(Si)	203krad(Si)	24h/25°C	168h/100°C
N° 1 (Ref)	---	-1.419E-1	-1.514E-1	-1.743E-1	-1.813E-1	-2.017E-1	-2.022E-1	-2.052E-1	-1.499E-1	-1.494E-1	-1.329E-1
N° 2 (Bias1)	---	-1.345E-1	-1.469E-1	-1.699E-1	-1.743E-1	-1.659E-1	-2.057E-1	-2.177E-1	-1.649E-1	-1.614E-1	-1.883E-1
N° 3 (Bias1)	---	-1.398E-1	-1.488E-1	-1.812E-1	-1.946E-1	-1.832E-1	-1.892E-1	-1.907E-1	-1.852E-1	-1.667E-1	-1.622E-1
N° 4 (Bias1)	---	-1.658E-1	-1.628E-1	-1.768E-1	-1.628E-1	-1.763E-1	-1.962E-1	-1.778E-1	-1.688E-1	-1.882E-1	-1.832E-1
N° 5 (Bias1)	---	-1.654E-1	-1.684E-1	-1.843E-1	-1.784E-1	-1.963E-1	-2.028E-1	-1.918E-1	-1.779E-1	-1.734E-1	-1.778E-1
N° 6 (Bias1)	---	-1.537E-1	-1.726E-1	-1.711E-1	-1.731E-1	-1.940E-1	-1.930E-1	-2.030E-1	-1.970E-1	-1.940E-1	-1.831E-1
N° 7 (Bias2)	---	-1.587E-1	-1.422E-1	-1.866E-1	-1.682E-1	-1.756E-1	-1.941E-1	-1.961E-1	-1.926E-1	-1.901E-1	-1.876E-1
N° 8 (Bias2)	---	-1.403E-1	-1.452E-1	-1.632E-1	-1.667E-1	-1.632E-1	-2.000E-1	-1.632E-1	-1.662E-1	-1.966E-1	-1.856E-1
N° 9 (Bias2)	---	-1.395E-1	-1.464E-1	-1.629E-1	-1.415E-1	-1.689E-1	-1.659E-1	-1.604E-1	-2.062E-1	-1.778E-1	-1.903E-1
N° 10 (Bias2)	---	-1.587E-1	-1.692E-1	-1.737E-1	-1.851E-1	-2.026E-1	-1.866E-1	-1.702E-1	-1.961E-1	-1.986E-1	-1.966E-1
N° 11 (Bias2)	---	-1.818E-1	-1.734E-1	-1.838E-1	-1.798E-1	-2.067E-1	-2.087E-1	-1.923E-1	-1.719E-1	-2.107E-1	-2.346E-1
N° 12 (OFF)	---	-1.660E-1	-1.606E-1	-1.710E-1	-1.825E-1	-1.815E-1	-2.019E-1	-1.740E-1	-1.576E-1	-2.069E-1	-2.193E-1
N° 13 (OFF)	---	-1.575E-1	-1.724E-1	-1.904E-1	-1.824E-1	-1.984E-1	-2.083E-1	-2.063E-1	-1.600E-1	-2.287E-1	-2.098E-1
N° 14 (OFF)	---	-1.346E-1	-1.212E-1	-1.317E-1	-1.391E-1	-1.606E-1	-1.655E-1	-1.476E-1	-1.645E-1	-1.760E-1	-1.835E-1
N° 15 (OFF)	---	-1.714E-1	-1.773E-1	-1.694E-1	-1.743E-1	-1.838E-1	-1.993E-1	-1.933E-1	-1.808E-1	-2.187E-1	-2.242E-1
N° 16 (OFF)	---	-1.328E-1	-1.323E-1	-1.343E-1	-1.278E-1	-1.238E-1	-1.532E-1	-1.338E-1	-1.368E-1	-1.582E-1	-1.427E-1
Average (Bias1)	---	-1.518E-1	-1.599E-1	-1.767E-1	-1.767E-1	-1.831E-1	-1.974E-1	-1.962E-1	-1.787E-1	-1.767E-1	-1.789E-1
σ (Bias1)	---	1.438E-2	1.155E-2	6.254E-3	1.158E-2	1.262E-2	6.826E-3	1.498E-2	1.292E-2	1.395E-2	1.003E-2
Average+3σ (Bias1)	---	-1.087E-1	-1.253E-1	-1.579E-1	-1.419E-1	-1.453E-1	-1.769E-1	-1.512E-1	-1.400E-1	-1.349E-1	-1.488E-1
Average-3σ (Bias1)	---	-1.950E-1	-1.945E-1	-1.954E-1	-2.114E-1	-2.210E-1	-2.179E-1	-2.411E-1	-2.175E-1	-2.186E-1	-2.090E-1
Average (Bias2)	---	-1.558E-1	-1.553E-1	-1.740E-1	-1.683E-1	-1.834E-1	-1.911E-1	-1.764E-1	-1.866E-1	-1.947E-1	-1.989E-1
σ (Bias2)	---	1.734E-2	1.474E-2	1.113E-2	1.688E-2	1.995E-2	1.625E-2	1.665E-2	1.692E-2	1.205E-2	2.038E-2
Average+3σ (Bias2)	---	-1.038E-1	-1.111E-1	-1.406E-1	-1.176E-1	-1.235E-1	-1.423E-1	-1.265E-1	-1.358E-1	-1.586E-1	-1.378E-1
Average-3σ (Bias2)	---	-2.078E-1	-1.995E-1	-2.074E-1	-2.189E-1	-2.433E-1	-2.398E-1	-2.264E-1	-2.373E-1	-2.309E-1	-2.601E-1
Average (OFF)	---	-1.525E-1	-1.528E-1	-1.593E-1	-1.612E-1	-1.696E-1	-1.856E-1	-1.710E-1	-1.599E-1	-1.977E-1	-1.959E-1
σ (OFF)	---	1.782E-2	2.484E-2	2.547E-2	2.587E-2	2.893E-2	2.459E-2	3.035E-2	1.580E-2	2.966E-2	3.362E-2
Average+3σ (OFF)	---	-9.900E-2	-7.825E-2	-8.294E-2	-8.362E-2	-8.283E-2	-1.119E-1	-7.994E-2	-1.125E-1	-1.087E-1	-9.505E-2
Average-3σ (OFF)	---	-2.059E-1	-2.273E-1	-2.357E-1	-2.389E-1	-2.564E-1	-2.594E-1	-2.621E-1	-2.074E-1	-2.867E-1	-2.968E-1

7. VF

Ta=25°C; If = 1.6 mA

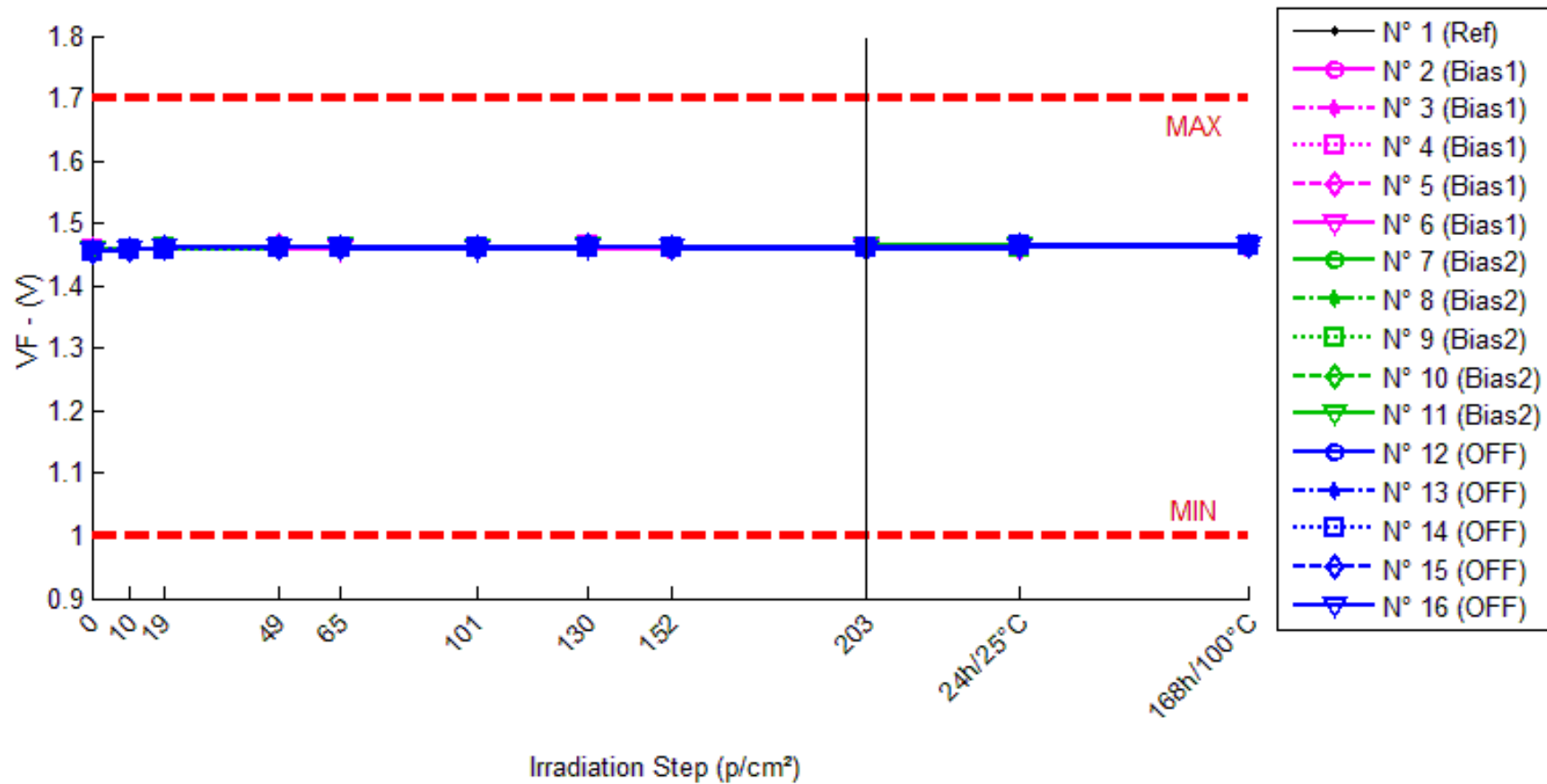

VF . (V) Min = 1.0 Max = 1.7

	Okrad(Si)	10krad(Si)	19krad(Si)	49krad(Si)	65krad(Si)	101krad(Si)	130krad(Si)	152krad(Si)	203krad(Si)	24h/25°C	168h/100°C
N° 1 (Ref)	1.461	1.459	1.463	1.464	1.463	1.463	1.466	1.460	1.464	1.465	1.466
N° 2 (Bias1)	1.456	1.457	1.460	1.462	1.460	1.462	1.462	1.459	1.461	1.462	1.461
N° 3 (Bias1)	1.457	1.459	1.461	1.463	1.461	1.462	1.463	1.461	1.462	1.463	1.463
N° 4 (Bias1)	1.458	1.459	1.461	1.461	1.462	1.462	1.463	1.461	1.462	1.460	1.466
N° 5 (Bias1)	1.458	1.459	1.460	1.463	1.461	1.462	1.463	1.461	1.462	1.461	1.466
N° 6 (Bias1)	1.457	1.458	1.461	1.462	1.459	1.461	1.462	1.461	1.461	1.462	1.465
N° 7 (Bias2)	1.457	1.458	1.459	1.462	1.460	1.460	1.462	1.461	1.461	1.461	1.465
N° 8 (Bias2)	1.458	1.459	1.461	1.463	1.462	1.460	1.464	1.462	1.462	1.463	1.467
N° 9 (Bias2)	1.456	1.458	1.460	1.462	1.460	1.460	1.462	1.461	1.461	1.461	1.466
N° 10 (Bias2)	1.455	1.458	1.460	1.462	1.462	1.461	1.463	1.461	1.460	1.463	1.465
N° 11 (Bias2)	1.458	1.459	1.461	1.461	1.463	1.461	1.463	1.461	1.463	1.464	1.465
N° 12 (OFF)	1.456	1.459	1.461	1.462	1.462	1.461	1.463	1.462	1.462	1.463	1.465
N° 13 (OFF)	1.457	1.459	1.461	1.462	1.462	1.461	1.462	1.462	1.462	1.463	1.466
N° 14 (OFF)	1.456	1.459	1.459	1.461	1.462	1.461	1.462	1.461	1.462	1.463	1.465
N° 15 (OFF)	1.455	1.459	1.461	1.462	1.462	1.461	1.463	1.462	1.461	1.464	1.466
N° 16 (OFF)	1.455	1.457	1.460	1.461	1.460	1.459	1.461	1.460	1.459	1.462	1.464

Delta [VF]

	Okrad(Si)	10krad(Si)	19krad(Si)	49krad(Si)	65krad(Si)	101krad(Si)	130krad(Si)	152krad(Si)	203krad(Si)	24h/25°C	168h/100°C
N° 1 (Ref)	---	-2.507E-3	1.700E-3	3.102E-3	2.166E-3	1.290E-3	4.546E-3	-1.560E-3	2.994E-3	3.893E-3	4.907E-3
N° 2 (Bias1)	---	1.460E-3	4.642E-3	5.817E-3	4.367E-3	6.397E-3	6.350E-3	3.551E-3	5.650E-3	6.184E-3	5.507E-3
N° 3 (Bias1)	---	1.218E-3	4.021E-3	5.139E-3	3.887E-3	5.034E-3	5.895E-3	3.756E-3	4.424E-3	5.653E-3	5.134E-3
N° 4 (Bias1)	---	5.930E-4	2.943E-3	2.449E-3	3.342E-3	3.956E-3	4.751E-3	2.754E-3	3.380E-3	2.014E-3	7.462E-3
N° 5 (Bias1)	---	8.890E-4	2.807E-3	4.903E-3	3.698E-3	4.045E-3	5.167E-3	3.454E-3	4.159E-3	3.757E-3	7.861E-3
N° 6 (Bias1)	---	1.047E-3	3.585E-3	4.882E-3	2.473E-3	3.604E-3	4.985E-3	3.578E-3	4.001E-3	5.258E-3	7.636E-3
N° 7 (Bias2)	---	1.289E-3	2.666E-3	5.283E-3	3.665E-3	3.846E-3	5.462E-3	4.187E-3	4.167E-3	4.307E-3	8.665E-3
N° 8 (Bias2)	---	9.690E-4	2.880E-3	4.714E-3	4.088E-3	1.614E-3	5.274E-3	4.033E-3	4.188E-3	4.866E-3	8.706E-3
N° 9 (Bias2)	---	1.213E-3	3.771E-3	5.524E-3	3.786E-3	4.075E-3	5.887E-3	4.497E-3	4.805E-3	4.819E-3	9.700E-3
N° 10 (Bias2)	---	2.927E-3	4.737E-3	6.760E-3	6.897E-3	5.464E-3	7.347E-3	6.011E-3	5.335E-3	7.391E-3	9.355E-3
N° 11 (Bias2)	---	1.358E-3	3.510E-3	3.443E-3	4.741E-3	3.629E-3	5.390E-3	3.038E-3	5.026E-3	5.650E-3	7.353E-3
N° 12 (OFF)	---	2.627E-3	4.545E-3	5.417E-3	5.399E-3	4.409E-3	6.502E-3	5.344E-3	5.602E-3	6.943E-3	8.924E-3
N° 13 (OFF)	---	2.195E-3	4.108E-3	5.160E-3	5.122E-3	4.131E-3	5.411E-3	4.672E-3	5.012E-3	6.131E-3	8.632E-3
N° 14 (OFF)	---	2.304E-3	3.146E-3	5.091E-3	5.959E-3	4.299E-3	5.958E-3	4.776E-3	5.302E-3	6.429E-3	8.501E-3
N° 15 (OFF)	---	3.969E-3	5.825E-3	7.479E-3	7.016E-3	5.834E-3	8.203E-3	6.787E-3	6.438E-3	8.652E-3	1.102E-2
N° 16 (OFF)	---	2.450E-3	4.939E-3	5.808E-3	5.102E-3	4.052E-3	6.264E-3	4.766E-3	4.431E-3	7.092E-3	9.466E-3
Average (Bias1)	---	1.041E-3	3.600E-3	4.638E-3	3.553E-3	4.607E-3	5.430E-3	3.419E-3	4.323E-3	4.573E-3	6.720E-3
σ (Bias1)	---	3.282E-4	7.622E-4	1.281E-3	7.082E-4	1.133E-3	6.691E-4	3.872E-4	8.353E-4	1.692E-3	1.292E-3
Average+3σ (Bias1)	---	2.026E-3	5.886E-3	8.481E-3	5.678E-3	8.005E-3	7.437E-3	4.580E-3	6.829E-3	9.648E-3	1.060E-2
Average-3σ (Bias1)	---	5.695E-5	1.313E-3	7.954E-4	1.429E-3	1.209E-3	3.422E-3	2.257E-3	1.817E-3	-5.014E-4	2.844E-3
Average (Bias2)	---	1.551E-3	3.513E-3	5.145E-3	4.635E-3	3.726E-3	5.872E-3	4.353E-3	4.704E-3	5.407E-3	8.756E-3
σ (Bias2)	---	7.830E-4	8.190E-4	1.210E-3	1.331E-3	1.381E-3	8.564E-4	1.076E-3	5.164E-4	1.209E-3	8.985E-4
Average+3σ (Bias2)	---	3.900E-3	5.970E-3	8.774E-3	8.629E-3	7.868E-3	8.441E-3	7.580E-3	6.253E-3	9.033E-3	1.145E-2
Average-3σ (Bias2)	---	-7.977E-4	1.056E-3	1.516E-3	6.417E-4	-4.169E-4	3.303E-3	1.126E-3	3.155E-3	1.781E-3	6.060E-3
Average (OFF)	---	2.709E-3	4.513E-3	5.791E-3	5.720E-3	4.545E-3	6.468E-3	5.269E-3	5.357E-3	7.049E-3	9.308E-3
σ (OFF)	---	7.228E-4	9.920E-4	9.846E-4	8.030E-4	7.340E-4	1.052E-3	8.892E-4	7.430E-4	9.759E-4	1.026E-3
Average+3σ (OFF)	---	4.877E-3	7.489E-3	8.745E-3	8.129E-3	6.747E-3	9.625E-3	7.936E-3	7.586E-3	9.977E-3	1.239E-2
Average-3σ (OFF)	---	5.407E-4	1.536E-3	2.837E-3	3.311E-3	2.343E-3	3.310E-3	2.602E-3	3.128E-3	4.122E-3	6.231E-3

8. B_{Vr}

T_a=25°C; I_r = 10 μA

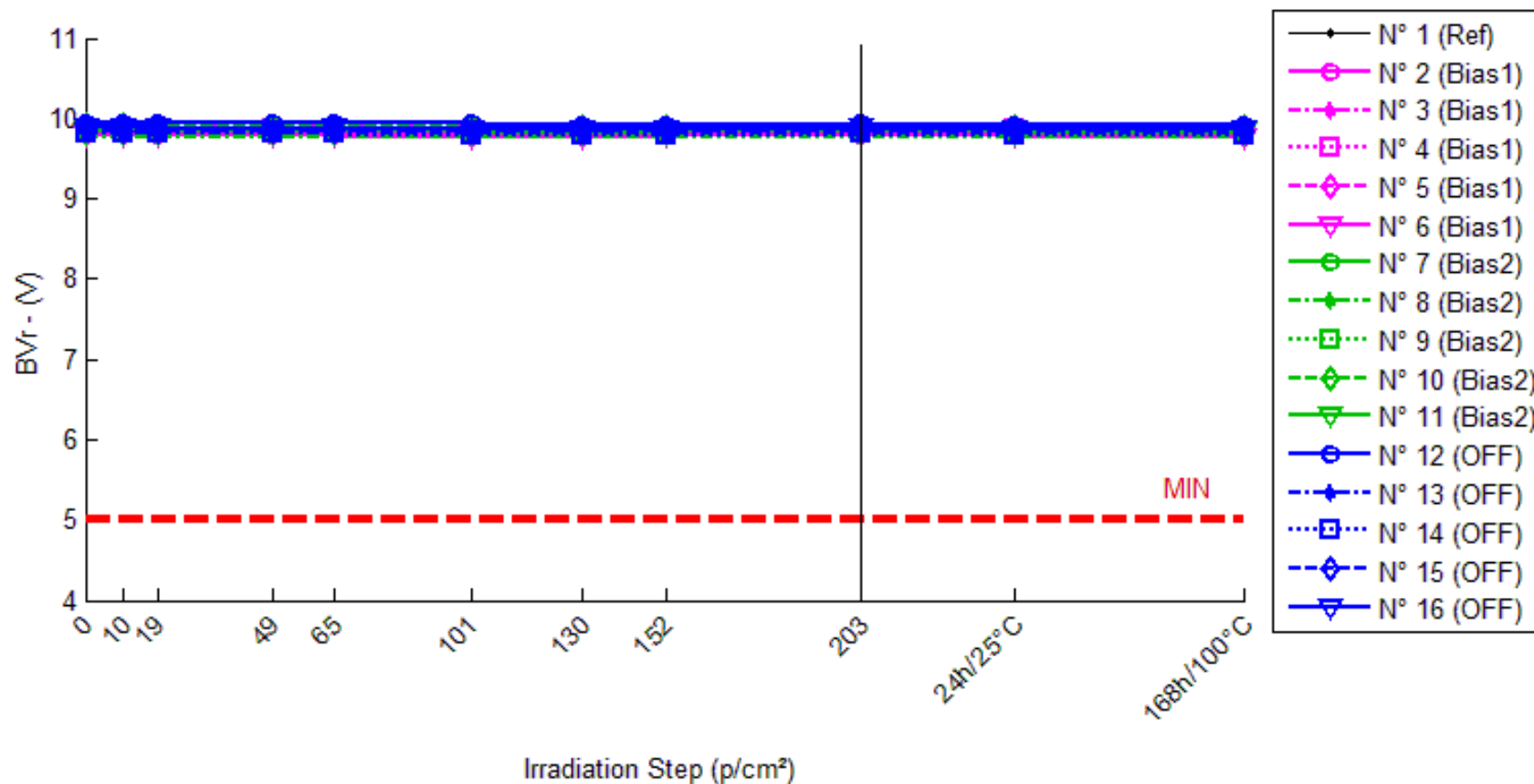

BVr . (V)

Min = 5.0

	0krad(Si)	10krad(Si)	19krad(Si)	49krad(Si)	65krad(Si)	101krad(Si)	130krad(Si)	152krad(Si)	203krad(Si)	24h/25°C	168h/100°C
N° 1 (Ref)	9.863	9.869	9.856	9.855	9.859	9.855	9.848	9.864	9.855	9.853	9.848
N° 2 (Bias1)	9.814	9.813	9.802	9.802	9.805	9.795	9.794	9.803	9.800	9.798	9.797
N° 3 (Bias1)	9.908	9.908	9.898	9.897	9.901	9.897	9.892	9.900	9.900	9.897	9.898
N° 4 (Bias1)	9.862	9.863	9.853	9.856	9.857	9.850	9.847	9.854	9.854	9.856	9.843
N° 5 (Bias1)	9.901	9.902	9.894	9.892	9.892	9.890	9.887	9.894	9.894	9.894	9.887
N° 6 (Bias1)	9.794	9.793	9.783	9.781	9.782	9.778	9.775	9.780	9.782	9.779	9.772
N° 7 (Bias2)	9.844	9.843	9.836	9.833	9.836	9.831	9.827	9.832	9.834	9.833	9.824
N° 8 (Bias2)	9.777	9.776	9.769	9.767	9.768	9.768	9.760	9.765	9.768	9.766	9.756
N° 9 (Bias2)	9.839	9.837	9.829	9.827	9.831	9.826	9.820	9.826	9.828	9.827	9.817
N° 10 (Bias2)	9.915	9.910	9.903	9.900	9.901	9.898	9.893	9.898	9.903	9.898	9.892
N° 11 (Bias2)	9.863	9.862	9.854	9.855	9.853	9.850	9.844	9.852	9.851	9.850	9.844
N° 12 (OFF)	9.945	9.941	9.934	9.933	9.933	9.931	9.925	9.930	9.932	9.929	9.923
N° 13 (OFF)	9.831	9.827	9.821	9.819	9.819	9.817	9.813	9.817	9.818	9.816	9.810
N° 14 (OFF)	9.817	9.813	9.808	9.805	9.805	9.804	9.797	9.803	9.804	9.802	9.795
N° 15 (OFF)	9.856	9.850	9.844	9.841	9.841	9.840	9.833	9.839	9.842	9.838	9.831
N° 16 (OFF)	9.892	9.888	9.881	9.879	9.881	9.879	9.873	9.878	9.882	9.877	9.869

Delta [Bvr]

	0krad(Si)	10krad(Si)	19krad(Si)	49krad(Si)	65krad(Si)	101krad(Si)	130krad(Si)	152krad(Si)	203krad(Si)	24h/25°C	168h/100°C
N° 1 (Ref)	---	6.466E-3	-6.844E-3	-7.315E-3	-3.924E-3	-7.237E-3	-1.500E-2	9.080E-4	-7.173E-3	-9.679E-3	-1.454E-2
N° 2 (Bias1)	---	-6.730E-4	-1.178E-2	-1.230E-2	-9.276E-3	-1.892E-2	-2.045E-2	-1.059E-2	-1.363E-2	-1.554E-2	-1.725E-2
N° 3 (Bias1)	---	-5.700E-5	-1.041E-2	-1.073E-2	-7.304E-3	-1.125E-2	-1.606E-2	-8.396E-3	-8.445E-3	-1.128E-2	-1.066E-2
N° 4 (Bias1)	---	3.190E-4	-9.300E-3	-5.872E-3	-5.343E-3	-1.240E-2	-1.546E-2	-8.121E-3	-8.112E-3	-6.629E-3	-1.914E-2
N° 5 (Bias1)	---	4.690E-4	-7.529E-3	-9.546E-3	-9.680E-3	-1.170E-2	-1.434E-2	-7.492E-3	-7.059E-3	-7.246E-3	-1.415E-2
N° 6 (Bias1)	---	-1.090E-3	-1.064E-2	-1.289E-2	-1.203E-2	-1.610E-2	-1.925E-2	-1.376E-2	-1.212E-2	-1.499E-2	-2.245E-2
N° 7 (Bias2)	---	-1.396E-3	-7.871E-3	-1.168E-2	-8.600E-3	-1.323E-2	-1.752E-2	-1.214E-2	-1.026E-2	-1.100E-2	-2.069E-2
N° 8 (Bias2)	---	-9.790E-4	-8.337E-3	-1.071E-2	-9.080E-3	-9.121E-3	-1.779E-2	-1.230E-2	-9.507E-3	-1.160E-2	-2.180E-2
N° 9 (Bias2)	---	-1.310E-3	-9.307E-3	-1.194E-2	-8.052E-3	-1.319E-2	-1.846E-2	-1.313E-2	-1.052E-2	-1.200E-2	-2.214E-2
N° 10 (Bias2)	---	-4.177E-3	-1.133E-2	-1.483E-2	-1.407E-2	-1.626E-2	-2.201E-2	-1.650E-2	-1.205E-2	-1.677E-2	-2.244E-2
N° 11 (Bias2)	---	-1.408E-3	-9.126E-3	-8.731E-3	-1.082E-2	-1.332E-2	-1.901E-2	-1.167E-2	-1.233E-2	-1.369E-2	-1.927E-2
N° 12 (OFF)	---	-4.023E-3	-1.091E-2	-1.217E-2	-1.195E-2	-1.399E-2	-2.018E-2	-1.516E-2	-1.316E-2	-1.571E-2	-2.168E-2
N° 13 (OFF)	---	-3.481E-3	-9.974E-3	-1.181E-2	-1.134E-2	-1.333E-2	-1.783E-2	-1.418E-2	-1.259E-2	-1.447E-2	-2.089E-2
N° 14 (OFF)	---	-4.111E-3	-8.468E-3	-1.204E-2	-1.302E-2	-1.401E-2	-1.928E-2	-1.410E-2	-1.319E-2	-1.490E-2	-2.162E-2
N° 15 (OFF)	---	-6.223E-3	-1.222E-2	-1.529E-2	-1.440E-2	-1.577E-2	-2.253E-2	-1.707E-2	-1.349E-2	-1.824E-2	-2.517E-2
N° 16 (OFF)	---	-4.103E-3	-1.102E-2	-1.334E-2	-1.124E-2	-1.286E-2	-1.929E-2	-1.385E-2	-9.888E-3	-1.549E-2	-2.309E-2
Average (Bias1)	---	-2.064E-4	-9.931E-3	-1.027E-2	-8.726E-3	-1.407E-2	-1.711E-2	-9.671E-3	-9.874E-3	-1.114E-2	-1.673E-2
σ (Bias1)	---	6.620E-4	1.606E-3	2.787E-3	2.529E-3	3.318E-3	2.608E-3	2.565E-3	2.840E-3	4.174E-3	4.535E-3
Average+3σ (Bias1)	---	1.780E-3	-5.114E-3	-1.907E-3	-1.140E-3	-4.120E-3	-9.288E-3	-1.975E-3	-1.355E-3	1.385E-3	-3.123E-3
Average-3σ (Bias1)	---	-2.192E-3	-1.475E-2	-1.863E-2	-1.631E-2	-2.403E-2	-2.494E-2	-1.737E-2	-1.839E-2	-2.366E-2	-3.034E-2
Average (Bias2)	---	-1.854E-3	-9.194E-3	-1.158E-2	-1.012E-2	-1.302E-2	-1.896E-2	-1.315E-2	-1.093E-2	-1.301E-2	-2.127E-2
σ (Bias2)	---	1.310E-3	1.328E-3	2.211E-3	2.437E-3	2.543E-3	1.800E-3	1.947E-3	1.209E-3	2.327E-3	1.301E-3
Average+3σ (Bias2)	---	2.077E-3	-5.209E-3	-4.945E-3	-2.814E-3	-5.395E-3	-1.356E-2	-7.308E-3	-7.306E-3	-6.032E-3	-1.736E-2
Average-3σ (Bias2)	---	-5.785E-3	-1.318E-2	-1.821E-2	-1.743E-2	-2.065E-2	-2.436E-2	-1.899E-2	-1.456E-2	-2.000E-2	-2.517E-2
Average (OFF)	---	-4.388E-3	-1.052E-2	-1.293E-2	-1.239E-2	-1.399E-2	-1.982E-2	-1.487E-2	-1.246E-2	-1.576E-2	-2.249E-2
σ (OFF)	---	1.058E-3	1.395E-3	1.446E-3	1.326E-3	1.103E-3	1.729E-3	1.324E-3	1.475E-3	1.469E-3	1.698E-3
Average+3σ (OFF)	---	-1.213E-3	-6.332E-3	-8.594E-3	-8.410E-3	-1.068E-2	-1.464E-2	-1.090E-2	-8.036E-3	-1.135E-2	-1.739E-2
Average-3σ (OFF)	---	-7.563E-3	-1.470E-2	-1.727E-2	-1.637E-2	-1.730E-2	-2.501E-2	-1.885E-2	-1.689E-2	-2.017E-2	-2.758E-2

9. TPHL 1

Ta=25°C; If = 0.5 mA; RL = 4.7 kOhms; Vcc = 5 V

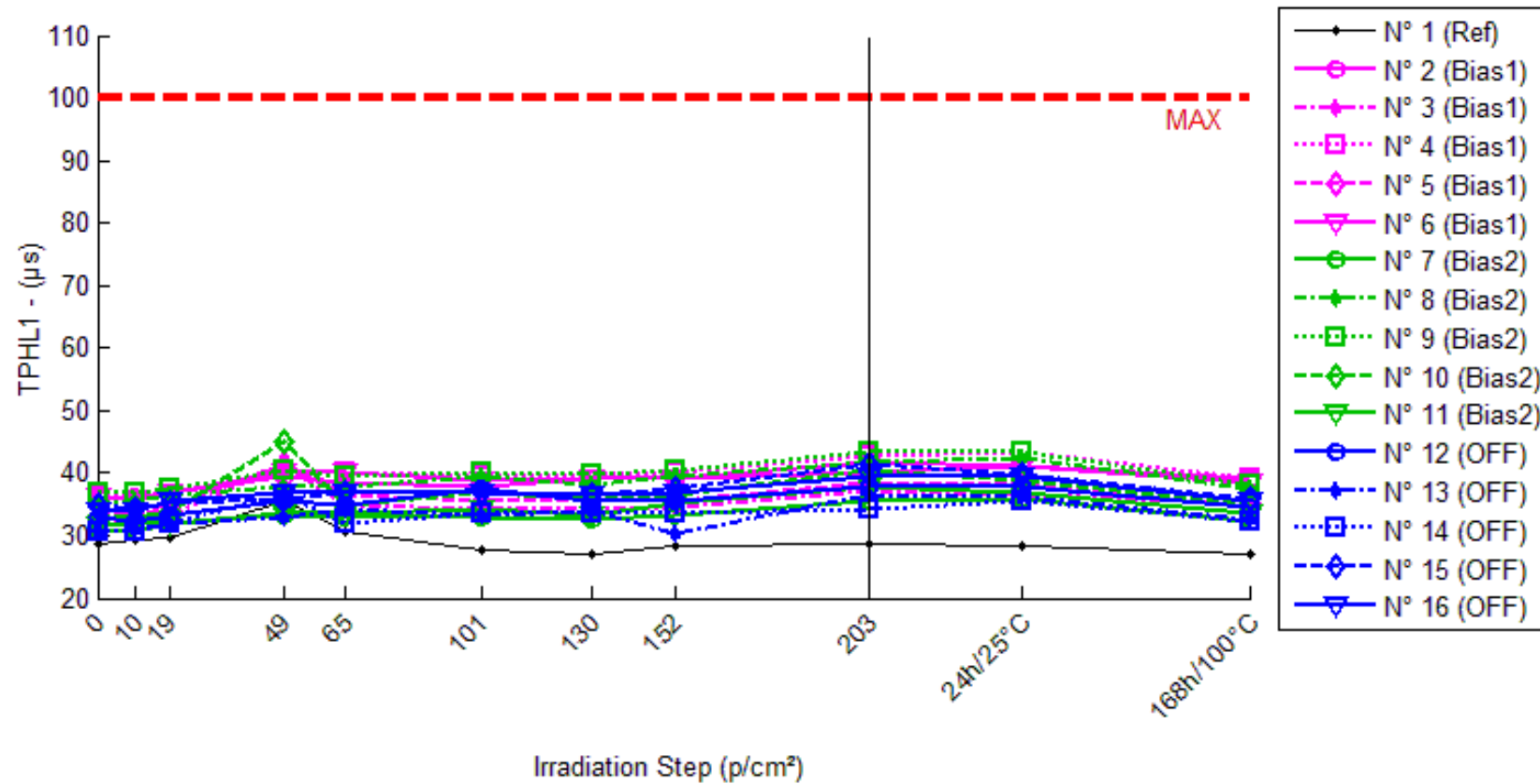

TPHL1 . (µs) Max = 100.0

	0krad(Si)	10krad(Si)	19krad(Si)	49krad(Si)	65krad(Si)	101krad(Si)	130krad(Si)	152krad(Si)	203krad(Si)	24h/25°C	168h/100°C
N° 1 (Ref)	28.8	29.2	29.6	35.4	30.6	27.8	27.0	28.2	28.6	28.3	27.1
N° 2 (Bias1)	36.0	36.2	36.8	39.6	38.6	38.0	39.0	39.1	40.1	41.1	39.0
N° 3 (Bias1)	32.2	32.4	33.2	41.4	35.0	34.2	34.4	34.5	37.1	36.5	35.1
N° 4 (Bias1)	36.4	37.0	37.6	40.4	40.2	39.5	39.8	40.0	42.6	43.3	39.0
N° 5 (Bias1)	33.2	33.4	34.6	41.6	36.4	35.4	35.6	35.6	38.4	38.2	35.3
N° 6 (Bias1)	36.2	36.0	37.0	40.0	40.0	38.8	39.2	39.0	41.7	41.2	38.4
N° 7 (Bias2)	30.8	30.8	31.8	33.4	32.8	33.0	32.7	33.4	35.4	36.0	32.2
N° 8 (Bias2)	35.2	35.4	36.6	38.0	38.0	39.4	38.3	39.4	41.8	42.4	37.6
N° 9 (Bias2)	36.8	36.8	37.4	40.4	39.4	40.0	39.9	40.6	43.4	43.3	38.1
N° 10 (Bias2)	33.4	33.0	33.8	45.0	34.8	37.0	35.8	36.6	40.3	38.8	35.0
N° 11 (Bias2)	31.6	31.8	32.0	33.6	33.6	34.2	33.2	35.3	37.9	36.8	33.6
N° 12 (OFF)	32.8	32.4	33.2	35.4	35.0	37.4	35.4	35.6	38.0	37.9	34.6
N° 13 (OFF)	30.6	31.0	31.8	33.0	34.2	33.4	34.0	30.3	36.6	36.1	32.5
N° 14 (OFF)	30.8	30.8	32.0	36.4	32.0	33.6	33.5	33.6	34.4	35.6	32.4
N° 15 (OFF)	35.0	34.4	35.2	36.0	36.8	37.0	36.6	37.5	41.6	39.8	36.0
N° 16 (OFF)	34.0	34.0	35.4	36.8	37.0	37.0	36.6	36.7	39.4	39.4	35.7

Delta [TPHL1]

	0krad(Si)	10krad(Si)	19krad(Si)	49krad(Si)	65krad(Si)	101krad(Si)	130krad(Si)	152krad(Si)	203krad(Si)	24h/25°C	168h/100°C
N° 1 (Ref)	---	4.000E-1	8.000E-1	6.600E+0	1.800E+0	-1.000E+0	-1.800E+0	-6.000E-1	-2.000E-1	-5.000E-1	-1.700E+0
N° 2 (Bias1)	---	2.000E-1	8.000E-1	3.600E+0	2.600E+0	2.000E+0	3.000E+0	3.150E+0	4.100E+0	5.100E+0	3.000E+0
N° 3 (Bias1)	---	2.000E-1	1.000E+0	9.200E+0	2.800E+0	2.000E+0	2.200E+0	2.300E+0	4.900E+0	4.300E+0	2.900E+0
N° 4 (Bias1)	---	6.000E-1	1.200E+0	4.000E+0	3.800E+0	3.100E+0	3.400E+0	3.600E+0	6.250E+0	6.900E+0	2.600E+0
N° 5 (Bias1)	---	2.000E-1	1.400E+0	8.400E+0	3.200E+0	2.200E+0	2.400E+0	2.400E+0	5.200E+0	5.000E+0	2.100E+0
N° 6 (Bias1)	---	-2.000E-1	8.000E-1	3.800E+0	3.800E+0	2.600E+0	3.000E+0	2.800E+0	5.500E+0	5.000E+0	2.200E+0
N° 7 (Bias2)	---	0.000E+0	1.000E+0	2.600E+0	2.000E+0	2.200E+0	1.900E+0	2.550E+0	4.550E+0	5.200E+0	1.400E+0
N° 8 (Bias2)	---	2.000E-1	1.400E+0	2.800E+0	2.800E+0	4.200E+0	3.100E+0	4.200E+0	6.600E+0	7.200E+0	2.400E+0
N° 9 (Bias2)	---	0.000E+0	6.000E-1	3.600E+0	2.600E+0	3.200E+0	3.100E+0	3.800E+0	6.600E+0	6.500E+0	1.350E+0
N° 10 (Bias2)	---	-4.000E-1	4.000E-1	1.160E+1	1.400E+0	3.600E+0	2.400E+0	3.200E+0	6.900E+0	5.400E+0	1.600E+0
N° 11 (Bias2)	---	2.000E-1	4.000E-1	2.000E+0	2.000E+0	2.600E+0	1.600E+0	3.700E+0	6.250E+0	5.200E+0	2.000E+0
N° 12 (OFF)	---	-4.000E-1	4.000E-1	2.600E+0	2.200E+0	4.600E+0	2.600E+0	2.800E+0	5.200E+0	5.100E+0	1.850E+0
N° 13 (OFF)	---	4.000E-1	1.200E+0	2.400E+0	3.600E+0	2.800E+0	3.400E+0	-3.000E-1	6.000E+0	5.500E+0	1.900E+0
N° 14 (OFF)	---	0.000E+0	1.200E+0	5.600E+0	1.200E+0	2.800E+0	2.700E+0	2.800E+0	3.600E+0	4.800E+0	1.600E+0
N° 15 (OFF)	---	-6.000E-1	2.000E-1	1.000E+0	1.800E+0	2.000E+0	1.650E+0	2.450E+0	6.650E+0	4.750E+0	1.000E+0
N° 16 (OFF)	---	0.000E+0	1.400E+0	2.800E+0	3.000E+0	3.000E+0	2.600E+0	2.700E+0	5.400E+0	5.400E+0	1.700E+0
Average (Bias1)	---	2.000E-1	1.040E+0	5.800E+0	3.240E+0	2.380E+0	2.800E+0	2.850E+0	5.190E+0	5.260E+0	2.560E+0
σ (Bias1)	---	2.828E-1	2.608E-1	2.757E+0	5.550E-1	4.712E-1	4.899E-1	5.385E-1	7.893E-1	9.711E-1	4.037E-1
Average+3σ (Bias1)	---	1.049E+0	1.822E+0	1.407E+1	4.905E+0	3.794E+0	4.270E+0	4.466E+0	7.558E+0	8.173E+0	3.771E+0
Average-3σ (Bias1)	---	-6.485E-1	2.577E-1	-2.470E+0	1.575E+0	9.665E-1	1.330E+0	1.234E+0	2.822E+0	2.347E+0	1.349E+0
Average (Bias2)	---	-7.105E-16	7.600E-1	4.520E+0	2.160E+0	3.160E+0	2.420E+0	3.490E+0	6.180E+0	5.900E+0	1.750E+0
σ (Bias2)	---	2.449E-1	4.336E-1	3.999E+0	5.550E-1	7.925E-1	6.834E-1	6.348E-1	9.398E-1	9.055E-1	4.444E-1
Average+3σ (Bias2)	---	7.348E-1	2.061E+0	1.652E+1	3.825E+0	5.537E+0	4.470E+0	5.394E+0	8.999E+0	8.617E+0	3.083E+0
Average-3σ (Bias2)	---	-7.348E-1	-5.408E-1	-7.477E+0	4.951E-1	7.826E-1	3.699E-1	1.586E+0	3.361E+0	3.183E+0	4.168E-1
Average (OFF)	---	-1.200E-1	8.800E-1	2.880E+0	2.360E+0	3.040E+0	2.590E+0	2.090E+0	5.370E+0	5.110E+0	1.610E+0
σ (OFF)	---	3.899E-1	5.404E-1	1.677E+0	9.529E-1	9.529E-1	6.229E-1	1.344E+0	1.140E+0	3.399E-1	3.612E-1
Average+3σ (OFF)	---	1.050E+0	2.501E+0	7.911E+0	5.219E+0	5.899E+0	4.459E+0	6.121E+0	8.790E+0	6.130E+0	2.694E+0
Average-3σ (OFF)	---	-1.290E+0	-7.411E-1	-2.151E+0	-4.987E-1	1.813E-1	7.213E-1	-1.941E+0	1.950E+0	4.090E+0	5.263E-1

10.TPHL2

Ta=25°C; If = 1.6 mA; RL = 1.5 kOhms; Vcc = 5 V

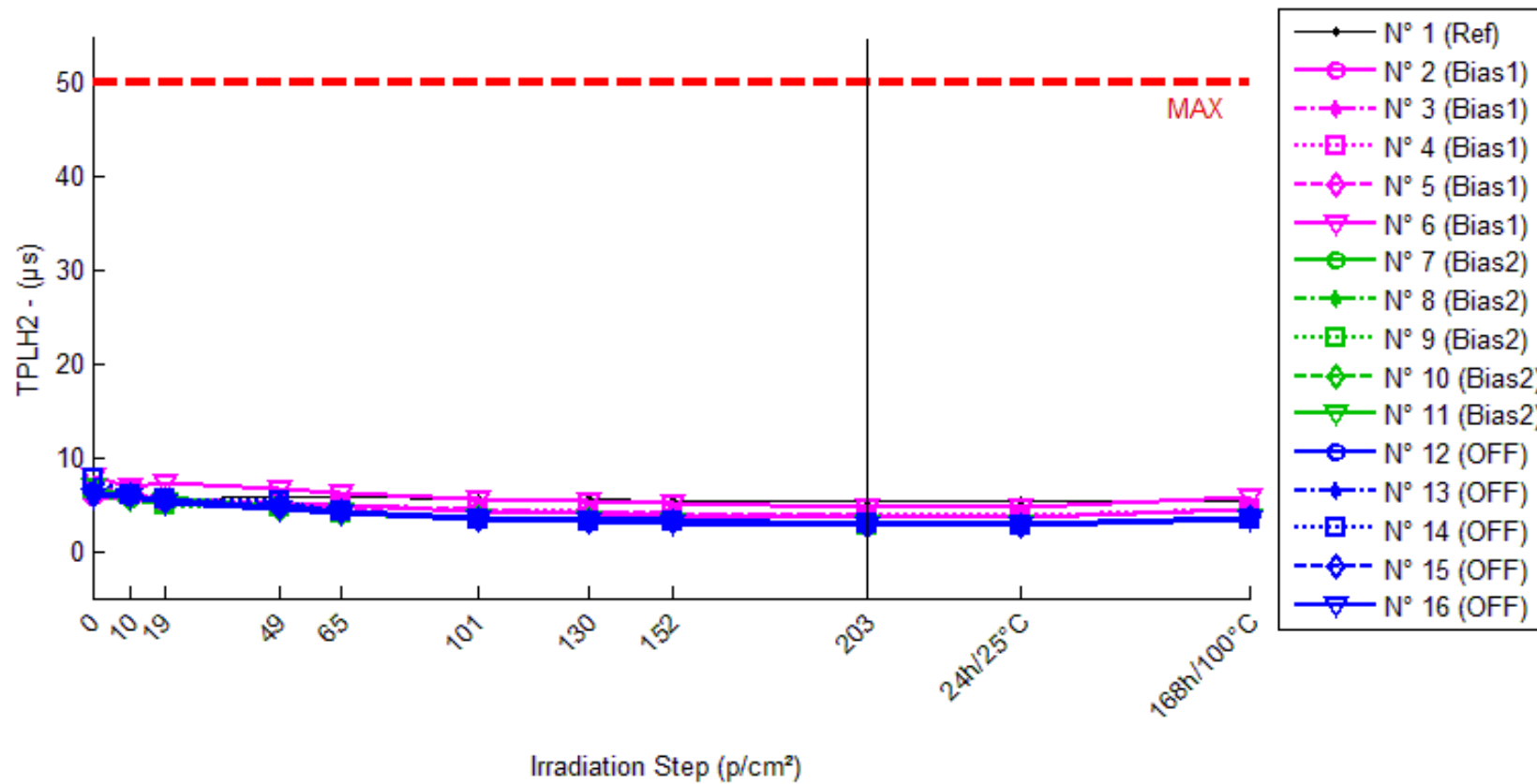

TPHL2 . (µs)

Max = 30.0

	0krad(Si)	10krad(Si)	19krad(Si)	49krad(Si)	65krad(Si)	101krad(Si)	130krad(Si)	152krad(Si)	203krad(Si)	24h/25°C	168h/100°C
N° 1 (Ref)	7.4	7.5	7.4	7.7	7.7	7.3	7.2	7.3	7.4	7.3	7.2
N° 2 (Bias1)	8.7	8.9	8.8	9.0	9.3	9.0	9.1	7.6	9.4	9.3	9.1
N° 3 (Bias1)	8.1	8.3	8.2	8.5	8.5	8.4	8.3	8.4	8.6	8.5	8.3
N° 4 (Bias1)	9.1	9.4	9.1	9.8	9.5	9.4	9.4	9.4	9.7	9.8	9.1
N° 5 (Bias1)	8.5	8.6	8.7	8.8	8.8	8.7	8.8	8.8	9.1	9.0	8.5
N° 6 (Bias1)	9.0	8.9	9.4	9.5	9.5	9.4	9.4	9.4	9.6	9.6	9.2
N° 7 (Bias2)	7.7	7.7	8.1	8.1	8.0	8.0	8.0	8.0	8.4	8.3	7.8
N° 8 (Bias2)	8.9	8.8	9.2	9.4	9.2	9.4	9.2	9.3	9.9	9.6	9.0
N° 9 (Bias2)	9.1	9.4	9.1	9.5	9.3	9.4	9.3	9.3	10.0	9.7	9.0
N° 10 (Bias2)	8.4	8.4	8.2	8.8	8.3	8.7	8.3	8.4	8.9	8.7	8.1
N° 11 (Bias2)	8.0	8.1	8.0	8.2	8.1	8.2	8.2	8.2	8.6	8.5	8.0
N° 12 (OFF)	8.2	8.3	8.5	8.6	8.5	9.0	8.6	8.6	9.0	8.9	8.4
N° 13 (OFF)	7.8	8.1	8.2	8.2	8.2	8.2	8.3	6.8	8.6	8.5	8.0
N° 14 (OFF)	8.3	8.1	8.2	8.8	8.1	8.2	8.2	8.2	8.4	8.4	8.0
N° 15 (OFF)	8.2	8.5	8.5	8.7	8.6	8.6	8.5	8.6	9.1	8.8	8.3
N° 16 (OFF)	8.0	8.4	8.4	8.6	8.4	8.6	8.4	7.0	8.9	8.7	8.2

Delta [TPHL2]

	0krad(Si)	10krad(Si)	19krad(Si)	49krad(Si)	65krad(Si)	101krad(Si)	130krad(Si)	152krad(Si)	203krad(Si)	24h/25°C	168h/100°C
N° 1 (Ref)	---	8.000E-2	0.000E+0	2.800E-1	2.600E-1	-1.400E-1	-2.400E-1	-1.200E-1	-4.000E-2	-1.200E-1	-2.400E-1
N° 2 (Bias1)	---	2.200E-1	1.400E-1	3.800E-1	6.400E-1	3.400E-1	4.400E-1	-1.020E+0	7.800E-1	6.800E-1	4.200E-1
N° 3 (Bias1)	---	2.000E-1	8.000E-2	4.000E-1	3.800E-1	2.800E-1	1.800E-1	2.400E-1	5.200E-1	3.800E-1	1.600E-1
N° 4 (Bias1)	---	3.600E-1	6.000E-2	7.200E-1	4.200E-1	3.200E-1	3.200E-1	3.400E-1	6.400E-1	6.800E-1	4.000E-2
N° 5 (Bias1)	---	1.600E-1	2.000E-1	3.600E-1	3.200E-1	2.200E-1	2.700E-1	3.200E-1	6.200E-1	5.400E-1	6.000E-2
N° 6 (Bias1)	---	-8.000E-2	3.400E-1	5.000E-1	4.800E-1	3.800E-1	3.800E-1	3.800E-1	5.800E-1	5.800E-1	1.800E-1
N° 7 (Bias2)	---	-4.000E-2	4.200E-1	3.400E-1	2.800E-1	2.800E-1	3.200E-1	3.200E-1	6.600E-1	6.000E-1	1.000E-1
N° 8 (Bias2)	---	-8.000E-2	2.400E-1	4.800E-1	2.800E-1	4.800E-1	2.800E-1	4.000E-1	9.600E-1	7.200E-1	8.000E-2
N° 9 (Bias2)	---	2.200E-1	-4.000E-2	3.600E-1	1.600E-1	2.600E-1	1.600E-1	1.800E-1	8.200E-1	5.400E-1	-1.200E-1
N° 10 (Bias2)	---	0.000E+0	-2.000E-1	4.500E-1	-1.000E-1	2.500E-1	-8.000E-2	0.000E+0	5.000E-1	2.600E-1	-2.600E-1
N° 11 (Bias2)	---	6.000E-2	2.000E-2	2.000E-1	1.000E-1	2.500E-1	1.800E-1	2.400E-1	6.000E-1	4.800E-1	2.000E-2
N° 12 (OFF)	---	8.000E-2	2.600E-1	4.000E-1	3.000E-1	8.000E-1	3.800E-1	3.800E-1	7.800E-1	6.600E-1	2.000E-1
N° 13 (OFF)	---	3.800E-1	4.000E-1	4.400E-1	4.400E-1	4.400E-1	5.200E-1	-1.000E+0	8.000E-1	7.200E-1	2.000E-1
N° 14 (OFF)	---	-2.000E-1	-8.000E-2	4.800E-1	-2.200E-1	-1.200E-1	-1.200E-1	-1.200E-1	1.200E-1	1.200E-1	-3.600E-1
N° 15 (OFF)	---	3.000E-1	3.400E-1	5.000E-1	4.000E-1	4.000E-1	3.200E-1	4.000E-1	9.200E-1	6.200E-1	1.200E-1
N° 16 (OFF)	---	4.200E-1	3.600E-1	5.500E-1	4.500E-1	6.000E-1	4.400E-1	-1.000E+0	8.800E-1	6.800E-1	2.200E-1
Average (Bias1)	---	1.720E-1	1.640E-1	4.720E-1	4.480E-1	3.080E-1	3.180E-1	5.200E-2	6.280E-1	5.720E-1	1.720E-1
σ (Bias1)	---	1.597E-1	1.126E-1	1.487E-1	1.221E-1	6.099E-2	1.001E-1	6.014E-1	9.654E-2	1.238E-1	1.514E-1
Average+3σ (Bias1)	---	6.512E-1	5.018E-1	9.182E-1	8.144E-1	4.910E-1	6.183E-1	1.856E+0	9.176E-1	9.433E-1	6.262E-1
Average-3σ (Bias1)	---	-3.072E-1	-1.738E-1	2.582E-2	8.156E-2	1.250E-1	1.770E-2	-1.752E+0	3.384E-1	2.007E-1	-2.822E-1
Average (Bias2)	---	3.200E-2	8.800E-2	3.660E-1	1.440E-1	3.040E-1	1.720E-1	2.280E-1	7.080E-1	5.200E-1	-3.600E-2
σ (Bias2)	---	1.171E-1	2.436E-1	1.099E-1	1.571E-1	9.915E-2	1.559E-1	1.521E-1	1.825E-1	1.703E-1	1.519E-1
Average+3σ (Bias2)	---	3.834E-1	8.187E-1	6.957E-1	6.153E-1	6.014E-1	6.398E-1	6.842E-1	1.256E+0	1.031E+0	4.198E-1
Average-3σ (Bias2)	---	-3.194E-1	-6.427E-1	3.627E-2	-3.273E-1	6.561E-3	-2.958E-1	-2.282E-1	1.604E-1	9.118E-3	-4.918E-1
Average (OFF)	---	1.960E-1	2.560E-1	4.740E-1	2.740E-1	4.240E-1	3.080E-1	-2.680E-1	7.000E-1	5.600E-1	7.600E-2
σ (OFF)	---	2.574E-1	1.946E-1	5.727E-2	2.825E-1	3.425E-1	2.504E-1	6.999E-1	3.292E-1	2.486E-1	2.467E-1
Average+3σ (OFF)	---	9.683E-1	8.399E-1	6.458E-1	1.121E+0	1.451E+0	1.059E+0	1.832E+0	1.688E+0	1.306E+0	8.162E-1
Average-3σ (OFF)	---	-5.763E-1	-3.279E-1	3.022E-1	-5.734E-1	-6.034E-1	-4.433E-1	-2.368E+0	-2.877E-1	-1.858E-1	-6.642E-1

11.TPHL3

Ta=25°C; If = 5 mA; RL = 680 Ohms; Vcc = 5 V

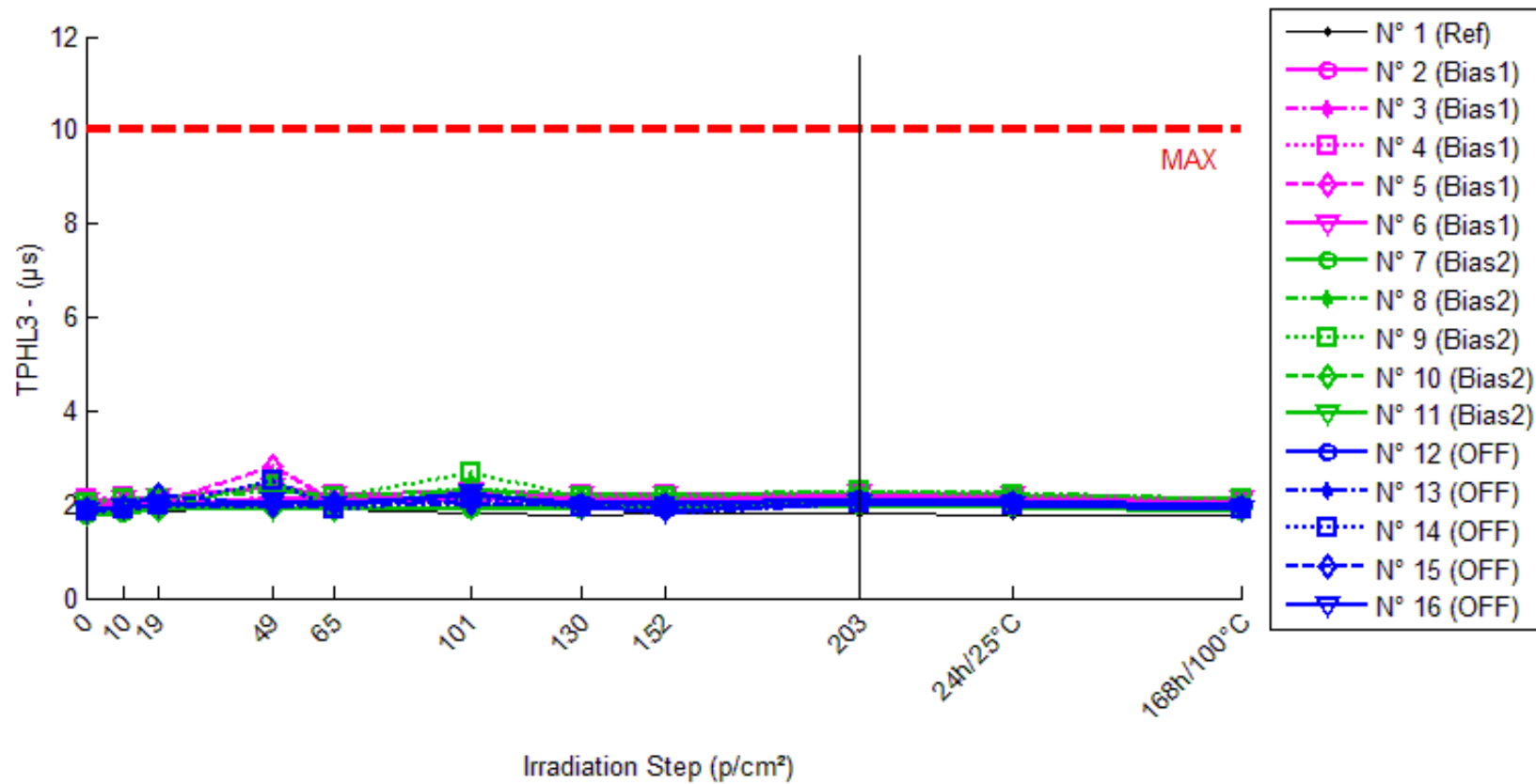

TPHL3 . (µs)

Max = 10.0

	0krad(Si)	10krad(Si)	19krad(Si)	49krad(Si)	65krad(Si)	101krad(Si)	130krad(Si)	152krad(Si)	203krad(Si)	24h/25°C	168h/100°C
N° 1 (Ref)	1.80	1.82	1.84	1.94	1.88	1.80	1.78	1.80	1.80	1.77	1.77
N° 2 (Bias1)	1.99	2.02	2.05	2.11	2.12	2.12	2.12	2.13	2.16	2.13	2.08
N° 3 (Bias1)	1.88	1.94	1.93	2.14	2.08	2.00	1.96	1.98	2.01	1.98	1.93
N° 4 (Bias1)	2.12	2.16	2.11	2.41	2.20	2.30	2.20	2.19	2.23	2.21	2.11
N° 5 (Bias1)	1.98	2.03	2.04	2.82	2.08	2.08	2.08	2.08	2.12	2.09	2.01
N° 6 (Bias1)	2.07	2.11	2.17	2.36	2.20	2.28	2.20	2.20	2.23	2.20	2.13
N° 7 (Bias2)	1.78	1.82	1.88	1.94	1.88	1.92	1.92	1.92	2.00	1.95	1.85
N° 8 (Bias2)	2.09	2.09	2.12	2.30	2.16	2.32	2.20	2.21	2.29	2.24	2.13
N° 9 (Bias2)	2.05	2.12	2.11	2.40	2.16	2.68	2.18	2.18	2.29	2.22	2.10
N° 10 (Bias2)	1.84	1.90	1.90	2.52	1.92	2.40	1.95	1.96	2.01	1.98	1.90
N° 11 (Bias2)	1.83	1.89	1.89	1.92	1.92	1.96	1.93	1.96	2.00	1.98	1.89
N° 12 (OFF)	1.90	1.96	1.99	2.04	2.04	2.20	2.04	2.05	2.10	2.07	1.98
N° 13 (OFF)	1.83	1.92	1.97	1.96	2.00	2.04	1.98	1.81	2.02	2.00	1.91
N° 14 (OFF)	1.87	1.91	1.97	2.52	1.92	2.12	1.96	1.96	2.01	1.99	1.90
N° 15 (OFF)	1.88	1.95	2.19	2.00	2.02	2.04	2.00	1.97	2.07	2.03	1.94
N° 16 (OFF)	1.84	1.93	1.99	2.08	2.00	2.24	1.96	1.84	2.03	1.99	1.90

Delta [TPHL3]

	0krad(Si)	10krad(Si)	19krad(Si)	49krad(Si)	65krad(Si)	101krad(Si)	130krad(Si)	152krad(Si)	203krad(Si)	24h/25°C	168h/100°C
N° 1 (Ref)	---	2.000E-2	4.000E-2	1.400E-1	8.000E-2	0.000E+0	-2.000E-2	0.000E+0	0.000E+0	-3.000E-2	-3.000E-2
N° 2 (Bias1)	---	3.000E-2	6.000E-2	1.200E-1	1.300E-1	1.300E-1	1.300E-1	1.400E-1	1.700E-1	1.400E-1	9.000E-2
N° 3 (Bias1)	---	6.000E-2	5.000E-2	2.600E-1	2.000E-1	1.200E-1	8.000E-2	1.000E-1	1.300E-1	1.000E-1	5.000E-2
N° 4 (Bias1)	---	4.000E-2	-1.000E-2	2.900E-1	8.000E-2	1.800E-1	8.000E-2	7.000E-2	1.100E-1	9.000E-2	-1.000E-2
N° 5 (Bias1)	---	5.000E-2	6.000E-2	8.400E-1	1.000E-1	1.000E-1	1.000E-1	1.000E-1	1.400E-1	1.100E-1	3.000E-2
N° 6 (Bias1)	---	4.000E-2	1.000E-1	2.900E-1	1.300E-1	2.100E-1	1.300E-1	1.300E-1	1.600E-1	1.300E-1	6.000E-2
N° 7 (Bias2)	---	4.000E-2	1.000E-1	1.600E-1	1.000E-1	1.400E-1	1.400E-1	1.400E-1	2.200E-1	1.700E-1	7.000E-2
N° 8 (Bias2)	---	0.000E+0	3.000E-2	2.100E-1	7.000E-2	2.300E-1	1.100E-1	1.200E-1	2.000E-1	1.500E-1	4.000E-2
N° 9 (Bias2)	---	7.000E-2	6.000E-2	3.500E-1	1.100E-1	6.300E-1	1.300E-1	1.300E-1	2.400E-1	1.700E-1	5.000E-2
N° 10 (Bias2)	---	6.000E-2	6.000E-2	6.800E-1	8.000E-2	5.600E-1	1.100E-1	1.200E-1	1.700E-1	1.400E-1	6.000E-2
N° 11 (Bias2)	---	6.000E-2	6.000E-2	9.000E-2	9.000E-2	1.300E-1	1.000E-1	1.300E-1	1.700E-1	1.500E-1	6.000E-2
N° 12 (OFF)	---	6.000E-2	9.000E-2	1.400E-1	1.400E-1	3.000E-1	1.400E-1	1.500E-1	2.000E-1	1.700E-1	8.000E-2
N° 13 (OFF)	---	9.000E-2	1.400E-1	1.300E-1	1.700E-1	2.100E-1	1.500E-1	-2.000E-2	1.900E-1	1.700E-1	8.000E-2
N° 14 (OFF)	---	4.000E-2	1.000E-1	6.500E-1	5.000E-2	2.500E-1	9.000E-2	9.000E-2	1.400E-1	1.200E-1	3.000E-2
N° 15 (OFF)	---	7.000E-2	3.100E-1	1.200E-1	1.400E-1	1.600E-1	1.200E-1	9.000E-2	1.900E-1	1.500E-1	6.000E-2
N° 16 (OFF)	---	9.000E-2	1.500E-1	2.400E-1	1.600E-1	4.000E-1	1.200E-1	0.000E+0	1.900E-1	1.500E-1	6.000E-2
Average (Bias1)	---	4.400E-2	5.200E-2	3.600E-1	1.280E-1	1.480E-1	1.040E-1	1.080E-1	1.420E-1	1.140E-1	4.400E-2
σ (Bias1)	---	1.140E-2	3.962E-2	2.774E-1	4.550E-2	4.550E-2	2.510E-2	2.775E-2	2.387E-2	2.074E-2	3.715E-2
Average+3σ (Bias1)	---	7.821E-2	1.709E-1	1.192E+0	2.645E-1	2.845E-1	1.793E-1	1.912E-1	2.136E-1	1.762E-1	1.554E-1
Average-3σ (Bias1)	---	9.795E-3	-6.687E-2	-4.722E-1	-8.492E-3	1.151E-2	2.870E-2	2.475E-2	7.038E-2	5.179E-2	-6.745E-2
Average (Bias2)	---	4.600E-2	6.200E-2	2.980E-1	9.000E-2	3.380E-1	1.180E-1	1.280E-1	2.000E-1	1.560E-1	5.600E-2
σ (Bias2)	---	2.793E-2	2.490E-2	2.338E-1	1.581E-2	2.391E-1	1.643E-2	8.367E-3	3.082E-2	1.342E-2	1.140E-2
Average+3σ (Bias2)	---	1.298E-1	1.367E-1	9.994E-1	1.374E-1	1.055E+0	1.673E-1	1.531E-1	2.925E-1	1.962E-1	9.021E-2
Average-3σ (Bias2)	---	-3.779E-2	-1.270E-2	-4.034E-1	4.257E-2	-3.793E-1	6.870E-2	1.029E-1	1.075E-1	1.158E-1	2.179E-2
Average (OFF)	---	7.000E-2	1.580E-1	2.560E-1	1.320E-1	2.640E-1	1.240E-1	6.200E-2	1.820E-1	1.520E-1	6.200E-2
σ (OFF)	---	2.121E-2	8.871E-2	2.255E-1	4.764E-2	9.182E-2	2.302E-2	7.050E-2	2.387E-2	2.049E-2	2.049E-2
Average+3σ (OFF)	---	1.336E-1	4.241E-1	9.324E-1	2.749E-1	5.394E-1	1.931E-1	2.735E-1	2.536E-1	2.135E-1	1.235E-1
Average-3σ (OFF)	---	6.360E-3	-1.081E-1	-4.204E-1	-1.093E-2	-1.145E-2	5.493E-2	-1.495E-1	1.104E-1	9.052E-2	5.183E-4

12.TPLH1

Ta=25°C; If = 0.5 mA; RL = 4.7 kOhms; Vcc = 5 V

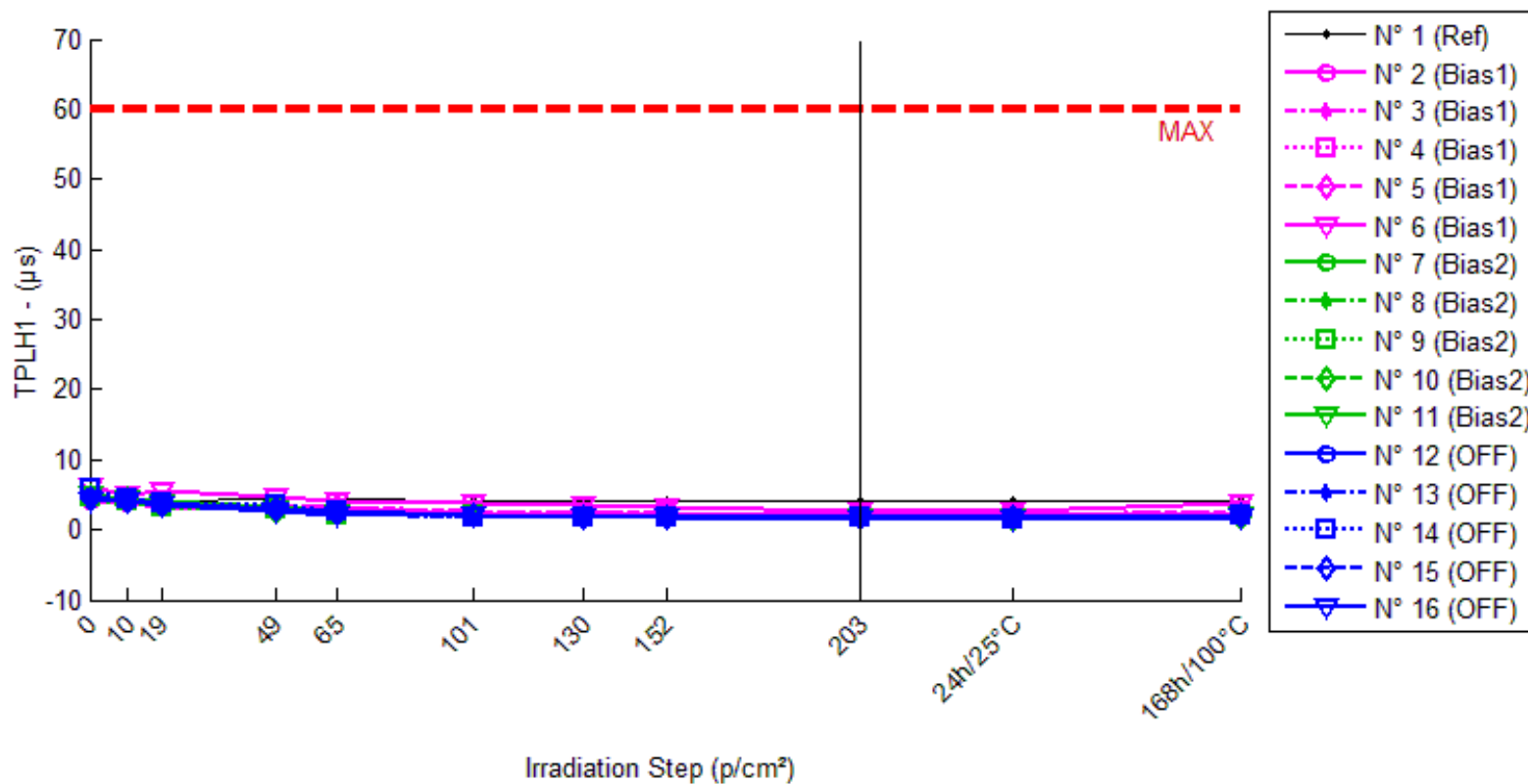

TPLH1 . (µs) Max = 60.0

	0krad(Si)	10krad(Si)	19krad(Si)	49krad(Si)	65krad(Si)	101krad(Si)	130krad(Si)	152krad(Si)	203krad(Si)	24h/25°C	168h/100°C
N° 1 (Ref)	4.5	4.3	4.0	4.3	4.4	4.2	4.2	4.1	4.1	4.0	4.0
N° 2 (Bias1)	4.0	3.8	3.2	3.0	3.0	2.4	2.2	2.2	2.1	2.1	2.5
N° 3 (Bias1)	4.7	4.4	3.7	3.3	3.2	2.6	2.4	2.3	2.1	2.1	2.8
N° 4 (Bias1)	4.6	4.6	3.6	3.3	3.0	2.6	2.4	2.3	2.2	2.2	2.7
N° 5 (Bias1)	4.7	4.4	3.8	3.3	3.2	2.6	2.4	2.3	2.1	2.1	2.8
N° 6 (Bias1)	6.1	5.1	5.5	4.7	4.2	3.7	3.4	3.2	2.8	2.8	3.8
N° 7 (Bias2)	4.9	4.0	4.2	3.1	2.6	2.0	1.9	1.8	1.7	1.7	2.1
N° 8 (Bias2)	4.4	3.4	3.4	2.8	2.2	2.0	1.9	1.8	1.7	1.6	1.9
N° 9 (Bias2)	4.7	4.1	3.2	3.0	2.2	2.0	1.8	1.8	1.8	1.6	2.0
N° 10 (Bias2)	4.7	4.3	3.4	2.6	2.4	2.0	1.8	1.8	1.7	1.6	1.9
N° 11 (Bias2)	5.1	4.3	3.7	3.0	2.4	2.0	1.8	1.8	1.7	1.7	2.0
N° 12 (OFF)	4.7	4.1	3.9	3.0	2.6	2.0	1.9	1.9	1.8	1.7	2.0
N° 13 (OFF)	4.4	4.3	3.7	2.8	2.4	1.8	1.8	1.7	1.6	1.6	1.9
N° 14 (OFF)	6.0	4.5	3.8	3.6	2.8	1.9	1.8	1.8	1.7	1.6	2.0
N° 15 (OFF)	4.3	4.2	3.5	3.0	2.4	2.0	1.9	1.8	1.7	1.7	2.0
N° 16 (OFF)	4.1	4.0	3.4	2.8	2.2	2.0	1.8	1.8	1.6	1.6	1.9

Delta [TPLH1]

	0krad(Si)	10krad(Si)	19krad(Si)	49krad(Si)	65krad(Si)	101krad(Si)	130krad(Si)	152krad(Si)	203krad(Si)	24h/25°C	168h/100°C
N° 1 (Ref)	---	-1.500E-1	-4.500E-1	-1.500E-1	-5.000E-2	-2.500E-1	-2.500E-1	-3.300E-1	-3.900E-1	-4.900E-1	-4.300E-1
N° 2 (Bias1)	---	-2.000E-1	-8.000E-1	-9.500E-1	-1.000E+0	-1.600E+0	-1.800E+0	-1.760E+0	-1.880E+0	-1.940E+0	-1.480E+0
N° 3 (Bias1)	---	-3.000E-1	-1.000E+0	-1.400E+0	-1.500E+0	-2.100E+0	-2.300E+0	-2.380E+0	-2.580E+0	-2.600E+0	-1.900E+0
N° 4 (Bias1)	---	0.000E+0	-1.000E+0	-1.300E+0	-1.600E+0	-2.000E+0	-2.200E+0	-2.320E+0	-2.400E+0	-2.400E+0	-1.860E+0
N° 5 (Bias1)	---	-3.000E-1	-9.000E-1	-1.400E+0	-1.500E+0	-2.100E+0	-2.300E+0	-2.400E+0	-2.580E+0	-2.580E+0	-1.900E+0
N° 6 (Bias1)	---	-1.000E+0	-6.000E-1	-1.400E+0	-1.900E+0	-2.400E+0	-2.700E+0	-2.900E+0	-3.340E+0	-3.340E+0	-2.300E+0
N° 7 (Bias2)	---	-9.000E-1	-7.500E-1	-1.800E+0	-2.300E+0	-2.900E+0	-2.980E+0	-3.100E+0	-3.180E+0	-3.180E+0	-2.760E+0
N° 8 (Bias2)	---	-1.000E+0	-1.000E+0	-1.600E+0	-2.200E+0	-2.400E+0	-2.500E+0	-2.560E+0	-2.680E+0	-2.760E+0	-2.480E+0
N° 9 (Bias2)	---	-6.000E-1	-1.500E+0	-1.700E+0	-2.500E+0	-2.700E+0	-2.860E+0	-2.860E+0	-2.940E+0	-3.060E+0	-2.680E+0
N° 10 (Bias2)	---	-3.500E-1	-1.250E+0	-2.050E+0	-2.250E+0	-2.650E+0	-2.830E+0	-2.850E+0	-2.930E+0	-3.050E+0	-2.710E+0
N° 11 (Bias2)	---	-8.000E-1	-1.400E+0	-2.100E+0	-2.700E+0	-3.100E+0	-3.340E+0	-3.260E+0	-3.420E+0	-3.420E+0	-3.080E+0
N° 12 (OFF)	---	-6.000E-1	-8.000E-1	-1.700E+0	-2.100E+0	-2.700E+0	-2.780E+0	-2.820E+0	-2.940E+0	-2.960E+0	-2.660E+0
N° 13 (OFF)	---	-1.000E-1	-7.000E-1	-1.600E+0	-2.000E+0	-2.600E+0	-2.600E+0	-2.680E+0	-2.840E+0	-2.800E+0	-2.480E+0
N° 14 (OFF)	---	-1.500E+0	-2.200E+0	-2.400E+0	-3.200E+0	-4.100E+0	-4.200E+0	-4.200E+0	-4.280E+0	-4.360E+0	-3.960E+0
N° 15 (OFF)	---	-1.000E-1	-7.500E-1	-1.300E+0	-1.900E+0	-2.300E+0	-2.420E+0	-2.500E+0	-2.560E+0	-2.620E+0	-2.260E+0
N° 16 (OFF)	---	-1.000E-1	-7.500E-1	-1.300E+0	-1.900E+0	-2.100E+0	-2.260E+0	-2.340E+0	-2.460E+0	-2.460E+0	-2.180E+0
Average (Bias1)	---	-3.600E-1	-8.600E-1	-1.290E+0	-1.500E+0	-2.040E+0	-2.260E+0	-2.352E+0	-2.556E+0	-2.572E+0	-1.888E+0
σ (Bias1)	---	3.782E-1	1.673E-1	1.949E-1	3.240E-1	2.881E-1	3.209E-1	4.046E-1	5.237E-1	5.049E-1	2.904E-1
Average+3σ (Bias1)	---	7.745E-1	-3.580E-1	-7.052E-1	-5.279E-1	-1.176E+0	-1.297E+0	-1.138E+0	-9.848E-1	-1.057E+0	-1.017E+0
Average-3σ (Bias1)	---	-1.494E+0	-1.362E+0	-1.875E+0	-2.472E+0	-2.904E+0	-3.223E+0	-3.566E+0	-4.127E+0	-4.087E+0	-2.759E+0
Average (Bias2)	---	-7.300E-1	-1.180E+0	-1.850E+0	-2.390E+0	-2.750E+0	-2.902E+0	-2.926E+0	-3.030E+0	-3.094E+0	-2.742E+0
σ (Bias2)	---	2.588E-1	3.054E-1	2.179E-1	2.074E-1	2.646E-1	3.027E-1	2.674E-1	2.807E-1	2.389E-1	2.168E-1
Average+3σ (Bias2)	---	4.653E-2	-2.639E-1	-1.196E+0	-1.768E+0	-1.956E+0	-1.994E+0	-2.124E+0	-2.188E+0	-2.377E+0	-2.091E+0
Average-3σ (Bias2)	---	-1.507E+0	-2.096E+0	-2.504E+0	-3.012E+0	-3.544E+0	-3.810E+0	-3.728E+0	-3.872E+0	-3.811E+0	-3.393E+0
Average (OFF)	---	-4.800E-1	-1.040E+0	-1.660E+0	-2.220E+0	-2.760E+0	-2.852E+0	-2.908E+0	-3.016E+0	-3.040E+0	-2.708E+0
σ (OFF)	---	6.099E-1	6.494E-1	4.506E-1	5.541E-1	7.861E-1	7.783E-1	7.447E-1	7.334E-1	7.614E-1	7.248E-1
Average+3σ (OFF)	---	1.350E+0	9.083E-1	-3.083E-1	-5.578E-1	-4.016E-1	-5.172E-1	-6.740E-1	-8.158E-1	-7.557E-1	-5.336E-1
Average-3σ (OFF)	---	-2.310E+0	-2.988E+0	-3.012E+0	-3.882E+0	-5.118E+0	-5.187E+0	-5.142E+0	-5.216E+0	-5.324E+0	-4.882E+0

13.TPLH2

Ta=25°C; If = 1.6 mA; RL = 1.5 kOhms; Vcc = 5 V

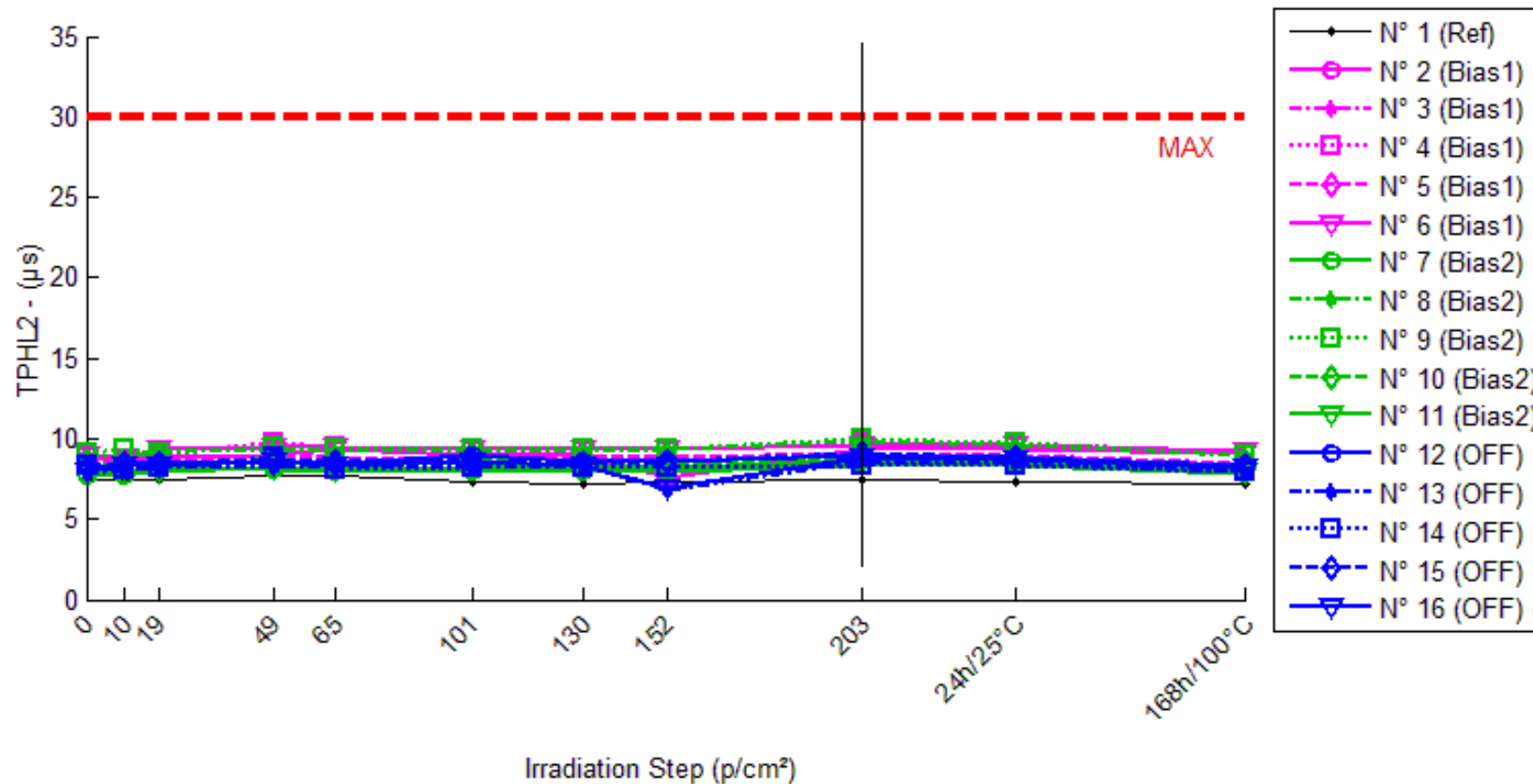

TPLH2 . (µs) Max = 50.0

	0krad(Si)	10krad(Si)	19krad(Si)	49krad(Si)	65krad(Si)	101krad(Si)	130krad(Si)	152krad(Si)	203krad(Si)	24h/25°C	168h/100°C
N° 1 (Ref)	6.0	5.8	5.5	5.8	5.8	5.6	5.6	5.4	5.4	5.3	5.3
N° 2 (Bias1)	5.9	5.5	5.0	4.9	5.0	4.2	4.0	3.9	3.7	3.6	4.4
N° 3 (Bias1)	6.4	6.0	5.3	5.0	5.0	4.4	4.1	4.0	3.8	3.7	4.6
N° 4 (Bias1)	6.5	6.4	5.4	5.2	5.0	4.4	4.2	4.1	3.9	3.8	4.6
N° 5 (Bias1)	6.4	6.0	5.5	5.2	4.8	4.4	4.1	4.0	3.9	3.7	4.5
N° 6 (Bias1)	8.0	7.0	7.3	6.7	6.2	5.6	5.4	5.1	4.8	4.7	5.7
N° 7 (Bias2)	6.5	5.5	5.8	4.7	4.2	3.6	3.4	3.4	3.0	3.0	3.7
N° 8 (Bias2)	6.2	5.2	5.1	4.8	4.0	3.4	3.2	3.0	2.7	2.7	3.5
N° 9 (Bias2)	6.6	6.0	5.0	4.8	4.0	3.4	3.2	3.1	2.7	2.7	3.5
N° 10 (Bias2)	6.4	6.0	5.2	4.4	4.0	3.6	3.3	3.1	2.9	2.8	3.6
N° 11 (Bias2)	6.8	5.9	5.3	4.6	4.2	3.6	3.4	3.2	2.9	2.9	3.6
N° 12 (OFF)	6.5	5.7	5.5	4.8	4.3	3.6	3.4	3.3	3.0	2.9	3.7
N° 13 (OFF)	6.0	5.8	5.2	4.4	4.0	3.4	3.2	3.1	2.7	2.7	3.5
N° 14 (OFF)	7.7	6.0	5.5	5.4	4.3	3.5	3.2	3.1	2.9	2.8	3.5
N° 15 (OFF)	6.2	6.0	5.3	5.0	4.2	3.4	3.2	3.2	2.8	2.8	3.6
N° 16 (OFF)	5.9	5.7	5.1	4.6	4.0	3.4	3.1	3.0	2.8	2.7	3.4

Delta [TPLH2]

	0krad(Si)	10krad(Si)	19krad(Si)	49krad(Si)	65krad(Si)	101krad(Si)	130krad(Si)	152krad(Si)	203krad(Si)	24h/25°C	168h/100°C
N° 1 (Ref)	---	-2.000E-1	-5.500E-1	-1.500E-1	-2.000E-1	-4.000E-1	-4.000E-1	-5.600E-1	-5.600E-1	-7.200E-1	-6.800E-1
N° 2 (Bias1)	---	-4.000E-1	-9.000E-1	-1.000E+0	-9.000E-1	-1.700E+0	-1.900E+0	-1.980E+0	-2.220E+0	-2.300E+0	-1.520E+0
N° 3 (Bias1)	---	-4.000E-1	-1.100E+0	-1.400E+0	-1.400E+0	-2.000E+0	-2.300E+0	-2.440E+0	-2.640E+0	-2.680E+0	-1.760E+0
N° 4 (Bias1)	---	-1.000E-1	-1.100E+0	-1.300E+0	-1.500E+0	-2.100E+0	-2.300E+0	-2.420E+0	-2.620E+0	-2.680E+0	-1.860E+0
N° 5 (Bias1)	---	-4.000E-1	-9.000E-1	-1.200E+0	-1.600E+0	-2.000E+0	-2.300E+0	-2.360E+0	-2.540E+0	-2.680E+0	-1.860E+0
N° 6 (Bias1)	---	-1.000E+0	-7.000E-1	-1.300E+0	-1.800E+0	-2.400E+0	-2.600E+0	-2.880E+0	-3.160E+0	-3.320E+0	-2.260E+0
N° 7 (Bias2)	---	-1.000E+0	-7.500E-1	-1.800E+0	-2.300E+0	-2.900E+0	-3.060E+0	-3.140E+0	-3.460E+0	-3.520E+0	-2.760E+0
N° 8 (Bias2)	---	-1.000E+0	-1.100E+0	-1.400E+0	-2.200E+0	-2.800E+0	-3.020E+0	-3.160E+0	-3.480E+0	-3.520E+0	-2.740E+0
N° 9 (Bias2)	---	-6.500E-1	-1.600E+0	-1.800E+0	-2.600E+0	-3.200E+0	-3.400E+0	-3.520E+0	-3.880E+0	-3.880E+0	-3.140E+0
N° 10 (Bias2)	---	-4.000E-1	-1.200E+0	-2.000E+0	-2.400E+0	-2.800E+0	-3.140E+0	-3.300E+0	-3.520E+0	-3.640E+0	-2.820E+0
N° 11 (Bias2)	---	-9.000E-1	-1.500E+0	-2.200E+0	-2.600E+0	-3.200E+0	-3.440E+0	-3.560E+0	-3.880E+0	-3.900E+0	-3.160E+0
N° 12 (OFF)	---	-8.000E-1	-1.000E+0	-1.700E+0	-2.200E+0	-2.900E+0	-3.140E+0	-3.180E+0	-3.500E+0	-3.580E+0	-2.780E+0
N° 13 (OFF)	---	-1.500E-1	-8.000E-1	-1.600E+0	-2.000E+0	-2.600E+0	-2.840E+0	-2.940E+0	-3.280E+0	-3.280E+0	-2.520E+0
N° 14 (OFF)	---	-1.650E+0	-2.150E+0	-2.250E+0	-3.350E+0	-4.150E+0	-4.410E+0	-4.530E+0	-4.770E+0	-4.890E+0	-4.130E+0
N° 15 (OFF)	---	-2.000E-1	-9.000E-1	-1.200E+0	-2.000E+0	-2.800E+0	-2.960E+0	-3.040E+0	-3.400E+0	-3.440E+0	-2.640E+0
N° 16 (OFF)	---	-2.000E-1	-8.000E-1	-1.300E+0	-1.900E+0	-2.500E+0	-2.760E+0	-2.900E+0	-3.140E+0	-3.220E+0	-2.520E+0
Average (Bias1)	---	-4.600E-1	-9.400E-1	-1.240E+0	-1.440E+0	-2.040E+0	-2.280E+0	-2.416E+0	-2.636E+0	-2.732E+0	-1.852E+0
σ (Bias1)	---	3.286E-1	1.673E-1	1.517E-1	3.362E-1	2.510E-1	2.490E-1	3.198E-1	3.381E-1	3.676E-1	2.671E-1
Average+3σ (Bias1)	---	5.259E-1	-4.380E-1	-7.850E-1	-4.315E-1	-1.287E+0	-1.533E+0	-1.457E+0	-1.622E+0	-1.629E+0	-1.051E+0
Average-3σ (Bias1)	---	-1.446E+0	-1.442E+0	-1.695E+0	-2.448E+0	-2.793E+0	-3.027E+0	-3.375E+0	-3.650E+0	-3.835E+0	-2.653E+0
Average (Bias2)	---	-7.900E-1	-1.230E+0	-1.840E+0	-2.420E+0	-2.980E+0	-3.212E+0	-3.336E+0	-3.644E+0	-3.692E+0	-2.924E+0
σ (Bias2)	---	2.608E-1	3.384E-1	2.966E-1	1.789E-1	2.049E-1	1.952E-1	1.967E-1	2.165E-1	1.874E-1	2.085E-1
Average+3σ (Bias2)	---	-7.696E-3	-2.149E-1	-9.501E-1	-1.883E+0	-2.365E+0	-2.626E+0	-2.746E+0	-2.994E+0	-3.130E+0	-2.298E+0
Average-3σ (Bias2)	---	-1.572E+0	-2.245E+0	-2.730E+0	-2.957E+0	-3.595E+0	-3.798E+0	-3.926E+0	-4.294E+0	-4.254E+0	-3.550E+0
Average (OFF)	---	-6.000E-1	-1.130E+0	-1.610E+0	-2.290E+0	-2.990E+0	-3.222E+0	-3.318E+0	-3.618E+0	-3.682E+0	-2.918E+0
σ (OFF)	---	6.452E-1	5.762E-1	4.129E-1	6.025E-1	6.675E-1	6.794E-1	6.861E-1	6.579E-1	6.898E-1	6.859E-1
Average+3σ (OFF)	---	1.336E+0	5.986E-1	-3.713E-1	-4.825E-1	-9.876E-1	-1.184E+0	-1.260E+0	-1.644E+0	-1.613E+0	-8.602E-1
Average-3σ (OFF)	---	-2.536E+0	-2.859E+0	-2.849E+0	-4.097E+0	-4.992E+0	-5.260E+0	-5.376E+0	-5.592E+0	-5.751E+0	-4.976E+0

14.TPLH3

Ta=25°C; If = 5 mA; RL = 680 Ohms; Vcc = 5 V

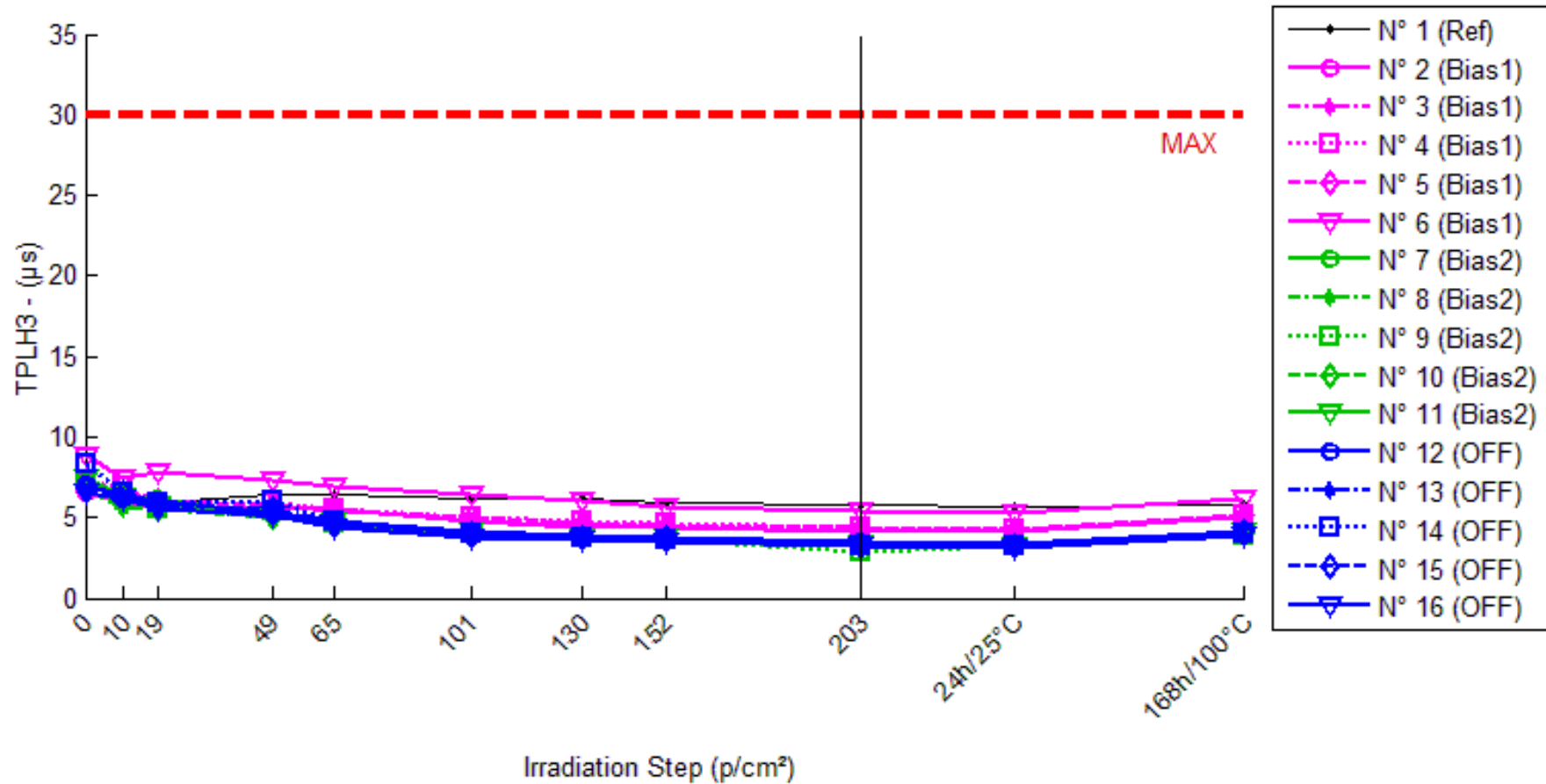

TPH3 . (µs) Max = 30.0

	0krad(Si)	10krad(Si)	19krad(Si)	49krad(Si)	65krad(Si)	101krad(Si)	130krad(Si)	152krad(Si)	203krad(Si)	24h/25°C	168h/100°C
N° 1 (Ref)	6.5	6.2	5.9	6.4	6.4	6.2	6.2	5.9	5.8	5.7	5.8
N° 2 (Bias1)	6.5	6.0	5.5	5.5	5.6	4.8	4.4	4.4	4.2	4.1	5.0
N° 3 (Bias1)	7.0	6.5	5.8	5.6	5.6	4.8	4.6	4.5	4.2	4.2	5.0
N° 4 (Bias1)	7.2	6.9	5.9	5.9	5.6	5.0	4.8	4.6	4.4	4.3	5.2
N° 5 (Bias1)	7.1	6.6	6.0	5.8	5.4	5.0	4.6	4.5	4.4	4.3	5.1
N° 6 (Bias1)	8.8	7.5	7.8	7.3	7.0	6.4	6.0	5.7	5.4	5.3	6.2
N° 7 (Bias2)	7.2	6.0	6.2	5.2	4.8	4.2	3.9	3.8	3.5	3.4	4.2
N° 8 (Bias2)	6.8	5.6	5.6	5.4	4.4	4.0	3.7	3.6	3.2	3.2	4.0
N° 9 (Bias2)	7.3	6.4	5.6	5.4	4.6	4.0	3.7	3.6	2.9	3.2	3.9
N° 10 (Bias2)	7.1	6.5	5.6	5.0	4.6	4.0	3.8	3.6	3.3	3.2	4.0
N° 11 (Bias2)	7.4	6.3	5.8	5.2	4.8	4.1	3.8	3.7	3.4	3.3	4.1
N° 12 (OFF)	7.1	6.2	6.0	5.3	4.8	4.2	3.9	3.8	3.5	3.4	4.2
N° 13 (OFF)	6.5	6.3	5.7	5.0	4.6	3.9	3.6	3.5	3.2	3.1	3.9
N° 14 (OFF)	8.3	6.5	5.9	6.0	4.8	4.0	3.7	3.6	3.3	3.2	4.0
N° 15 (OFF)	6.8	6.5	5.8	5.6	4.6	4.0	3.8	3.7	3.3	3.2	4.1
N° 16 (OFF)	6.5	6.2	5.5	5.2	4.4	3.8	3.6	3.5	3.2	3.1	3.9

Delta [TPH3]

	0krad(Si)	10krad(Si)	19krad(Si)	49krad(Si)	65krad(Si)	101krad(Si)	130krad(Si)	152krad(Si)	203krad(Si)	24h/25°C	168h/100°C
N° 1 (Ref)	---	-3.500E-1	-6.500E-1	-1.500E-1	-1.500E-1	-3.500E-1	-3.500E-1	-6.300E-1	-7.100E-1	-8.300E-1	-7.100E-1
N° 2 (Bias1)	---	-5.000E-1	-1.000E+0	-1.000E+0	-9.000E-1	-1.700E+0	-2.100E+0	-2.060E+0	-2.280E+0	-2.360E+0	-1.520E+0
N° 3 (Bias1)	---	-5.000E-1	-1.200E+0	-1.400E+0	-1.400E+0	-2.200E+0	-2.400E+0	-2.480E+0	-2.760E+0	-2.780E+0	-1.960E+0
N° 4 (Bias1)	---	-2.500E-1	-1.250E+0	-1.250E+0	-1.550E+0	-2.150E+0	-2.350E+0	-2.550E+0	-2.750E+0	-2.850E+0	-1.970E+0
N° 5 (Bias1)	---	-5.000E-1	-1.100E+0	-1.350E+0	-1.700E+0	-2.100E+0	-2.500E+0	-2.560E+0	-2.740E+0	-2.820E+0	-1.980E+0
N° 6 (Bias1)	---	-1.300E+0	-1.000E+0	-1.500E+0	-1.800E+0	-2.400E+0	-2.800E+0	-3.140E+0	-3.440E+0	-3.460E+0	-2.600E+0
N° 7 (Bias2)	---	-1.200E+0	-1.000E+0	-2.000E+0	-2.400E+0	-3.000E+0	-3.280E+0	-3.360E+0	-3.700E+0	-3.800E+0	-2.960E+0
N° 8 (Bias2)	---	-1.250E+0	-1.250E+0	-1.450E+0	-2.450E+0	-2.850E+0	-3.170E+0	-3.290E+0	-3.610E+0	-3.670E+0	-2.850E+0
N° 9 (Bias2)	---	-9.000E-1	-1.700E+0	-1.900E+0	-2.700E+0	-3.300E+0	-3.580E+0	-3.700E+0	-4.420E+0	-4.080E+0	-3.380E+0
N° 10 (Bias2)	---	-6.000E-1	-1.500E+0	-2.100E+0	-2.500E+0	-3.100E+0	-3.340E+0	-3.500E+0	-3.820E+0	-3.900E+0	-3.100E+0
N° 11 (Bias2)	---	-1.100E+0	-1.600E+0	-2.200E+0	-2.600E+0	-3.300E+0	-3.560E+0	-3.680E+0	-4.000E+0	-4.060E+0	-3.320E+0
N° 12 (OFF)	---	-9.000E-1	-1.100E+0	-1.800E+0	-2.300E+0	-2.900E+0	-3.220E+0	-3.340E+0	-3.640E+0	-3.720E+0	-2.940E+0
N° 13 (OFF)	---	-2.500E-1	-8.500E-1	-1.550E+0	-1.950E+0	-2.650E+0	-2.910E+0	-3.030E+0	-3.390E+0	-3.410E+0	-2.630E+0
N° 14 (OFF)	---	-1.800E+0	-2.400E+0	-2.300E+0	-3.500E+0	-4.300E+0	-4.580E+0	-4.700E+0	-5.000E+0	-5.100E+0	-4.320E+0
N° 15 (OFF)	---	-3.000E-1	-1.000E+0	-1.200E+0	-2.200E+0	-2.800E+0	-3.040E+0	-3.120E+0	-3.520E+0	-3.560E+0	-2.720E+0
N° 16 (OFF)	---	-3.000E-1	-1.000E+0	-1.300E+0	-2.100E+0	-2.700E+0	-2.880E+0	-3.020E+0	-3.300E+0	-3.380E+0	-2.580E+0
Average (Bias1)	---	-6.100E-1	-1.110E+0	-1.300E+0	-1.470E+0	-2.110E+0	-2.430E+0	-2.558E+0	-2.794E+0	-2.854E+0	-2.006E+0
σ (Bias1)	---	4.006E-1	1.140E-1	1.904E-1	3.528E-1	2.559E-1	2.540E-1	3.850E-1	4.146E-1	3.930E-1	3.851E-1
Average+3σ (Bias1)	---	5.919E-1	-7.679E-1	-7.288E-1	-4.115E-1	-1.342E+0	-1.668E+0	-1.403E+0	-1.550E+0	-1.675E+0	-8.508E-1
Average-3σ (Bias1)	---	-1.812E+0	-1.452E+0	-1.871E+0	-2.529E+0	-2.878E+0	-3.192E+0	-3.713E+0	-4.038E+0	-4.033E+0	-3.161E+0
Average (Bias2)	---	-1.010E+0	-1.410E+0	-1.930E+0	-2.530E+0	-3.110E+0	-3.386E+0	-3.506E+0	-3.910E+0	-3.902E+0	-3.122E+0
σ (Bias2)	---	2.655E-1	2.837E-1	2.907E-1	1.204E-1	1.949E-1	1.788E-1	1.843E-1	3.203E-1	1.738E-1	2.272E-1
Average+3σ (Bias2)	---	-2.134E-1	-5.588E-1	-1.058E+0	-2.169E+0	-2.525E+0	-2.850E+0	-2.953E+0	-2.949E+0	-3.380E+0	-2.440E+0
Average-3σ (Bias2)	---	-1.807E+0	-2.261E+0	-2.802E+0	-2.891E+0	-3.695E+0	-3.922E+0	-4.059E+0	-4.871E+0	-4.424E+0	-3.804E+0
Average (OFF)	---	-7.100E-1	-1.270E+0	-1.630E+0	-2.410E+0	-3.070E+0	-3.326E+0	-3.442E+0	-3.770E+0	-3.834E+0	-3.038E+0
σ (OFF)	---	6.656E-1	6.380E-1	4.410E-1	6.229E-1	6.943E-1	7.137E-1	7.149E-1	6.996E-1	7.205E-1	7.298E-1
Average+3σ (OFF)	---	1.287E+0	6.439E-1	-3.069E-1	-5.413E-1	-9.872E-1	-1.185E+0	-1.297E+0	-1.671E+0	-1.672E+0	-8.486E-1
Average-3σ (OFF)	---	-2.707E+0	-3.184E+0	-2.953E+0	-4.279E+0	-5.153E+0	-5.467E+0	-5.587E+0	-5.869E+0	-5.996E+0	-5.227E+0

15.CTR1

Ta=25°C; If = 5 mA; Vo = 0.4 V; Vcc = 4.5 V

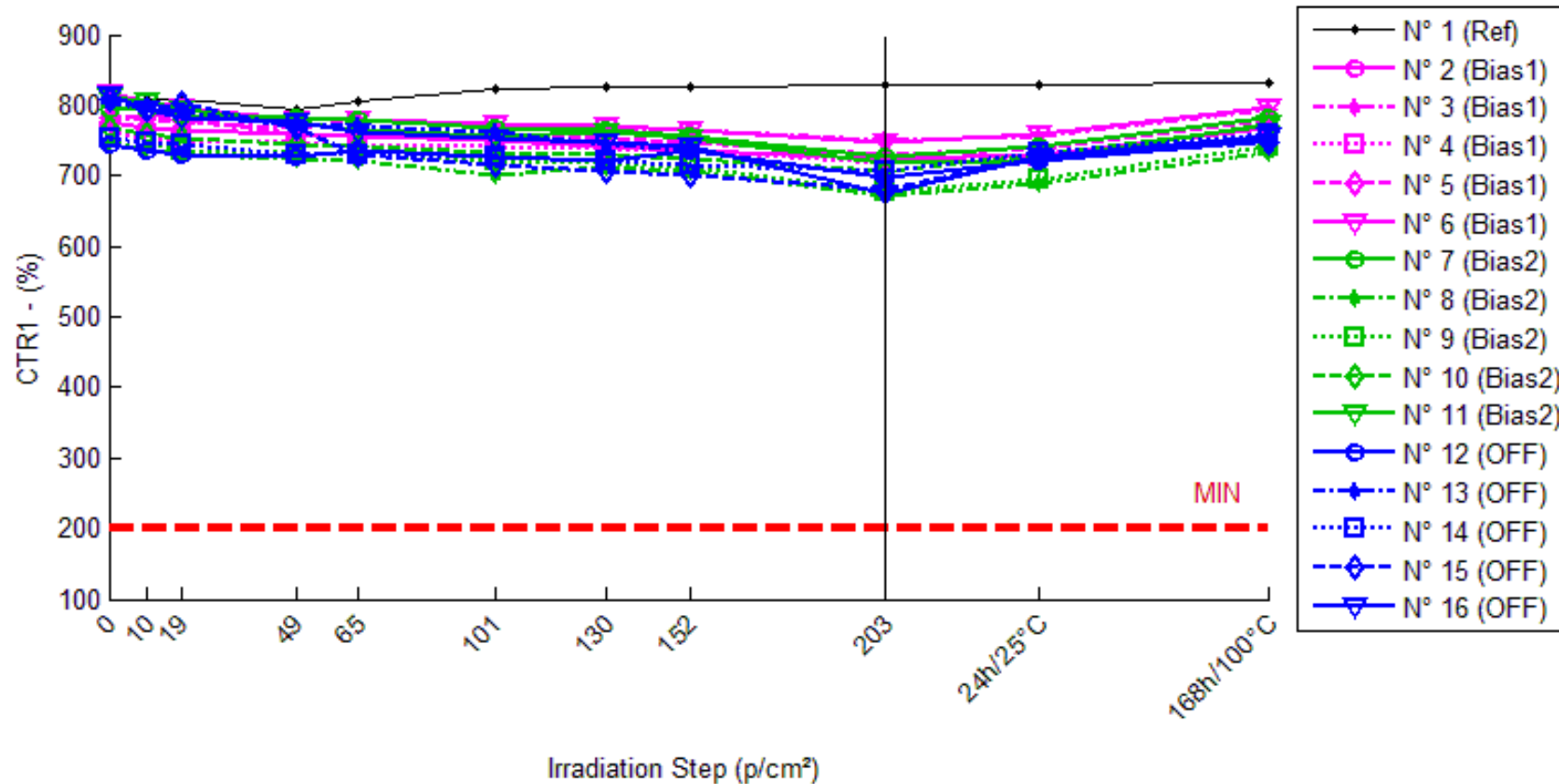

CTR1 . (%)

Min = 200.0

	0krad(Si)	10krad(Si)	19krad(Si)	49krad(Si)	65krad(Si)	101krad(Si)	130krad(Si)	152krad(Si)	203krad(Si)	24h/25°C	168h/100°C
N° 1 (Ref)	802.88	807.07	807.33	795.00	804.54	822.82	824.40	825.35	828.11	828.76	832.97
N° 2 (Bias1)	776.58	766.75	764.73	758.08	755.91	750.31	741.66	736.40	722.57	729.10	768.29
N° 3 (Bias1)	782.77	779.15	777.45	767.81	779.14	772.08	768.22	763.32	750.42	755.82	794.03
N° 4 (Bias1)	762.76	753.46	749.34	747.37	741.24	742.82	739.40	734.76	718.73	725.52	767.43
N° 5 (Bias1)	783.61	785.93	778.78	759.87	754.91	752.51	751.91	747.13	729.19	738.60	780.28
N° 6 (Bias1)	817.16	806.57	796.90	780.08	778.14	773.07	770.87	765.79	746.58	758.49	797.79
N° 7 (Bias2)	794.80	793.02	784.86	782.81	779.23	768.32	763.49	756.25	727.63	742.20	782.32
N° 8 (Bias2)	748.39	738.98	730.81	725.05	720.58	699.99	712.70	705.56	670.53	689.11	733.27
N° 9 (Bias2)	753.05	748.01	735.50	733.68	730.80	721.48	719.22	711.01	676.78	695.03	740.69
N° 10 (Bias2)	768.20	757.74	754.35	744.53	742.81	733.94	730.96	722.63	706.62	728.59	770.43
N° 11 (Bias2)	811.22	804.75	793.24	776.49	766.18	755.06	760.96	752.58	718.00	722.22	774.00
N° 12 (OFF)	744.51	736.03	730.11	727.75	735.60	725.78	722.50	735.91	699.12	721.92	751.25
N° 13 (OFF)	801.75	797.91	789.57	771.59	771.30	762.35	743.92	736.47	698.33	722.47	749.58
N° 14 (OFF)	753.45	748.53	743.56	731.20	729.34	726.21	721.51	714.65	705.24	731.90	759.97
N° 15 (OFF)	809.77	795.06	803.49	768.17	730.87	714.86	705.82	699.86	680.33	725.60	748.17
N° 16 (OFF)	814.08	792.63	782.52	776.04	762.28	752.52	746.71	740.10	675.47	727.26	755.40

1/Delta [CTR1]

	0krad(Si)	10krad(Si)	19krad(Si)	49krad(Si)	65krad(Si)	101krad(Si)	130krad(Si)	152krad(Si)	203krad(Si)	24h/25°C	168h/100°C
N° 1 (Ref)	---	-6.471E-6	-6.855E-6	1.234E-5	-2.568E-6	-3.018E-5	-3.251E-5	-3.391E-5	-3.794E-5	-3.889E-5	-4.499E-5
N° 2 (Bias1)	---	1.651E-5	1.995E-5	3.143E-5	3.521E-5	4.509E-5	6.064E-5	7.026E-5	9.625E-5	8.386E-5	1.389E-5
N° 3 (Bias1)	---	5.933E-6	8.751E-6	2.490E-5	5.955E-6	1.768E-5	2.420E-5	3.256E-5	5.508E-5	4.555E-5	-1.810E-5
N° 4 (Bias1)	---	1.618E-5	2.348E-5	2.699E-5	3.806E-5	3.520E-5	4.143E-5	4.997E-5	8.032E-5	6.730E-5	-7.982E-6
N° 5 (Bias1)	---	-3.769E-6	7.913E-6	3.986E-5	4.851E-5	5.274E-5	5.380E-5	6.231E-5	9.524E-5	7.776E-5	5.440E-6
N° 6 (Bias1)	---	1.606E-5	3.111E-5	5.816E-5	6.137E-5	6.979E-5	7.349E-5	8.209E-5	1.157E-4	9.465E-5	2.971E-5
N° 7 (Bias2)	---	2.834E-6	1.593E-5	1.927E-5	2.514E-5	4.337E-5	5.159E-5	6.413E-5	1.161E-4	8.916E-5	2.008E-5
N° 8 (Bias2)	---	1.701E-5	3.214E-5	4.301E-5	5.157E-5	9.238E-5	6.691E-5	8.112E-5	1.551E-4	1.150E-4	2.755E-5
N° 9 (Bias2)	---	8.942E-6	3.168E-5	3.506E-5	4.042E-5	5.811E-5	6.247E-5	7.852E-5	1.496E-4	1.109E-4	2.215E-5
N° 10 (Bias2)	---	1.797E-5	2.390E-5	4.139E-5	4.449E-5	6.077E-5	6.632E-5	8.209E-5	1.134E-4	7.078E-5	-3.763E-6
N° 11 (Bias2)	---	9.908E-6	2.794E-5	5.514E-5	7.248E-5	9.170E-5	8.141E-5	9.605E-5	1.601E-4	1.519E-4	5.929E-5
N° 12 (OFF)	---	1.547E-5	2.648E-5	3.093E-5	1.627E-5	3.467E-5	4.091E-5	1.569E-5	8.720E-5	4.203E-5	-1.205E-5
N° 13 (OFF)	---	6.001E-6	1.923E-5	4.875E-5	4.923E-5	6.445E-5	9.696E-5	1.106E-4	1.847E-4	1.369E-4	8.681E-5
N° 14 (OFF)	---	8.734E-6	1.765E-5	4.039E-5	4.388E-5	4.980E-5	5.876E-5	7.206E-5	9.074E-5	3.909E-5	-1.137E-5
N° 15 (OFF)	---	2.285E-5	9.660E-6	6.688E-5	1.333E-4	1.640E-4	1.819E-4	1.939E-4	2.349E-4	1.432E-4	1.017E-4
N° 16 (OFF)	---	3.325E-5	4.953E-5	6.022E-5	8.348E-5	1.005E-4	1.108E-4	1.228E-4	2.521E-4	1.466E-4	9.541E-5
Average (Bias1)	---	1.018E-5	1.824E-5	3.627E-5	3.782E-5	4.410E-5	5.071E-5	5.944E-5	8.852E-5	7.383E-5	4.592E-6
σ (Bias1)	---	8.990E-6	9.908E-6	1.352E-5	2.056E-5	1.945E-5	1.881E-5	1.904E-5	2.252E-5	1.865E-5	1.865E-5
Average+3σ (Bias1)	---	3.715E-5	4.797E-5	7.683E-5	9.951E-5	1.024E-4	1.072E-4	1.166E-4	1.561E-4	1.298E-4	6.055E-5
Average-3σ (Bias1)	---	-1.679E-5	-1.148E-5	-4.283E-6	-2.387E-5	-1.424E-5	-5.731E-6	2.316E-6	2.096E-5	1.787E-5	-5.136E-5
Average (Bias2)	---	1.133E-5	2.632E-5	3.877E-5	4.682E-5	6.927E-5	6.574E-5	8.038E-5	1.389E-4	1.075E-4	2.506E-5
σ (Bias2)	---	6.251E-6	6.689E-6	1.310E-5	1.730E-5	2.182E-5	1.070E-5	1.136E-5	2.232E-5	3.051E-5	2.259E-5
Average+3σ (Bias2)	---	3.009E-5	4.639E-5	7.808E-5	9.872E-5	1.347E-4	9.785E-5	1.145E-4	2.059E-4	1.991E-4	9.284E-5
Average-3σ (Bias2)	---	-7.419E-6	6.252E-6	-5.358E-7	-5.078E-6	3.808E-6	3.363E-5	4.630E-5	7.192E-5	1.600E-5	-4.272E-5
Average (OFF)	---	1.726E-5	2.451E-5	4.943E-5	6.523E-5	8.267E-5	9.787E-5	1.030E-4	1.699E-4	1.016E-4	5.210E-5
σ (OFF)	---	1.106E-5	1.521E-5	1.454E-5	4.493E-5	5.158E-5	5.477E-5	6.576E-5	7.796E-5	5.582E-5	5.849E-5
Average+3σ (OFF)	---	5.045E-5	7.014E-5	9.304E-5	2.000E-4	2.374E-4	2.622E-4	3.003E-4	4.038E-4	2.690E-4	2.276E-4
Average-3σ (OFF)	---	-1.593E-5	-2.112E-5	5.826E-6	-6.957E-5	-7.207E-5	-6.645E-5	-9.428E-5	-6.393E-5	-6.589E-5	-1.234E-4

16.CTR2

Ta=25°C; If = 0.5 mA; Vo = 0.4 V; Vcc = 5 V

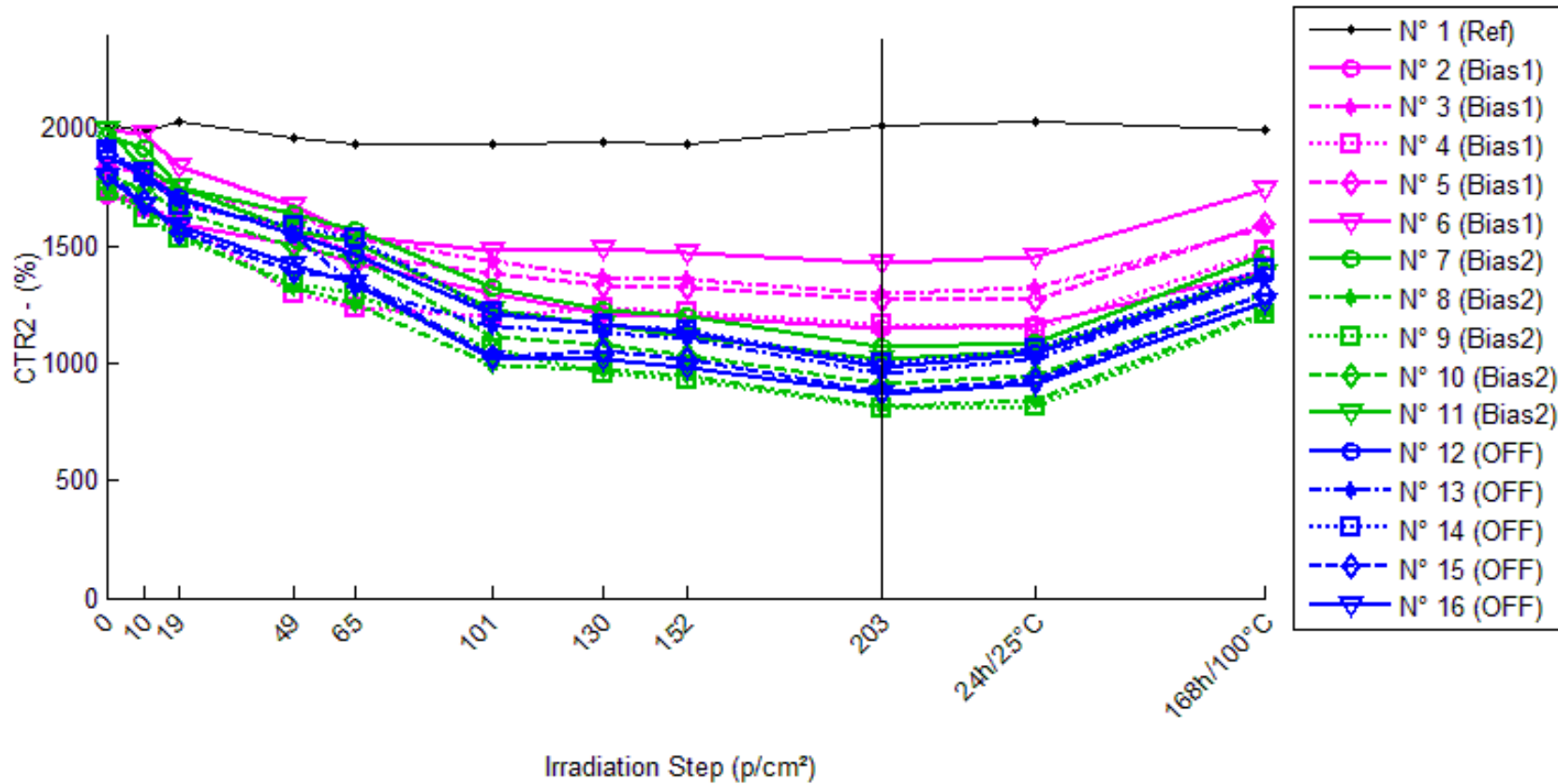

CTR2 . (%)

	0krad(Si)	10krad(Si)	19krad(Si)	49krad(Si)	65krad(Si)	101krad(Si)	130krad(Si)	152krad(Si)	203krad(Si)	24h/25°C	168h/100°C
N° 1 (Ref)	2018.03	1987.05	2025.37	1961.18	1936.05	1932.40	1940.17	1932.43	2014.73	2025.92	1993.32
N° 2 (Bias1)	1715.63	1668.26	1595.62	1501.34	1423.35	1297.97	1207.69	1197.78	1148.40	1163.36	1395.12
N° 3 (Bias1)	1844.59	1799.66	1730.24	1639.70	1532.26	1432.91	1368.52	1355.71	1296.58	1324.92	1571.00
N° 4 (Bias1)	1751.40	1664.76	1610.99	1296.04	1234.58	1195.73	1233.15	1218.58	1166.67	1149.44	1481.40
N° 5 (Bias1)	1839.13	1817.55	1678.56	1572.31	1464.25	1387.34	1330.83	1325.52	1268.44	1267.15	1593.08
N° 6 (Bias1)	1990.39	1978.43	1840.61	1667.49	1540.69	1482.42	1484.73	1472.73	1424.44	1453.39	1740.47
N° 7 (Bias2)	1970.51	1915.77	1750.19	1634.78	1564.54	1318.12	1229.59	1199.93	1067.66	1090.79	1464.46
N° 8 (Bias2)	1737.11	1658.88	1548.47	1320.71	1252.76	988.54	969.51	949.50	816.60	843.83	1216.66
N° 9 (Bias2)	1733.15	1621.85	1531.31	1343.72	1299.42	1060.78	958.66	927.05	806.20	812.35	1212.67
N° 10 (Bias2)	1795.97	1737.60	1648.06	1497.96	1446.64	1110.09	1080.68	1032.11	908.08	950.37	1293.33
N° 11 (Bias2)	1990.82	1827.82	1746.33	1564.12	1510.36	1228.79	1161.17	1110.41	1013.11	1049.49	1382.34
N° 12 (OFF)	1884.29	1798.01	1703.08	1548.95	1460.68	1206.82	1162.59	1127.87	983.53	1040.66	1378.33
N° 13 (OFF)	1924.44	1777.98	1701.53	1547.58	1323.30	1152.55	1133.28	1108.04	956.52	1015.40	1367.39
N° 14 (OFF)	1910.92	1814.44	1668.09	1585.01	1529.79	1219.08	1164.87	1135.68	997.36	1058.69	1398.42
N° 15 (OFF)	1804.90	1691.85	1560.57	1392.29	1354.88	1024.68	1053.49	1013.71	880.17	933.49	1292.80
N° 16 (OFF)	1797.81	1672.08	1584.44	1418.69	1341.76	1019.46	1015.72	985.50	865.99	915.99	1258.58

1/Delta [CTR2]

	0krad(Si)	10krad(Si)	19krad(Si)	49krad(Si)	65krad(Si)	101krad(Si)	130krad(Si)	152krad(Si)	203krad(Si)	24h/25°C	168h/100°C
N° 1 (Ref)	---	7.727E-6	-1.797E-6	1.436E-5	2.098E-5	2.196E-5	1.989E-5	2.195E-5	8.121E-7	-1.930E-6	6.142E-6
N° 2 (Bias1)	---	1.655E-5	4.384E-5	8.319E-5	1.197E-4	1.876E-4	2.452E-4	2.520E-4	2.879E-4	2.767E-4	1.339E-4
N° 3 (Bias1)	---	1.353E-5	3.583E-5	6.774E-5	1.105E-4	1.558E-4	1.886E-4	1.955E-4	2.291E-4	2.126E-4	9.441E-5
N° 4 (Bias1)	---	2.972E-5	4.977E-5	2.006E-4	2.390E-4	2.653E-4	2.400E-4	2.497E-4	2.862E-4	2.990E-4	1.041E-4
N° 5 (Bias1)	---	6.457E-6	5.201E-5	9.227E-5	1.392E-4	1.771E-4	2.077E-4	2.107E-4	2.446E-4	2.454E-4	8.398E-5
N° 6 (Bias1)	---	3.037E-6	4.088E-5	9.729E-5	1.466E-4	1.722E-4	1.711E-4	1.766E-4	1.996E-4	1.856E-4	7.214E-5
N° 7 (Bias2)	---	1.450E-5	6.389E-5	1.042E-4	1.317E-4	2.512E-4	3.058E-4	3.259E-4	4.291E-4	4.093E-4	1.754E-4
N° 8 (Bias2)	---	2.715E-5	7.013E-5	1.815E-4	2.226E-4	4.359E-4	4.558E-4	4.775E-4	6.489E-4	6.094E-4	2.463E-4
N° 9 (Bias2)	---	3.959E-5	7.605E-5	1.672E-4	1.926E-4	3.657E-4	4.661E-4	5.017E-4	6.634E-4	6.540E-4	2.476E-4
N° 10 (Bias2)	---	1.870E-5	4.997E-5	1.108E-4	1.345E-4	3.440E-4	3.685E-4	4.121E-4	5.444E-4	4.954E-4	2.164E-4
N° 11 (Bias2)	---	4.480E-5	7.032E-5	1.370E-4	1.598E-4	3.115E-4	3.589E-4	3.983E-4	4.848E-4	4.505E-4	2.211E-4
N° 12 (OFF)	---	2.547E-5	5.647E-5	1.149E-4	1.539E-4	2.979E-4	3.294E-4	3.559E-4	4.860E-4	4.302E-4	1.948E-4
N° 13 (OFF)	---	4.280E-5	6.808E-5	1.265E-4	2.361E-4	3.480E-4	3.628E-4	3.829E-4	5.258E-4	4.652E-4	2.117E-4
N° 14 (OFF)	---	2.783E-5	7.618E-5	1.076E-4	1.304E-4	2.970E-4	3.352E-4	3.572E-4	4.793E-4	4.213E-4	1.918E-4
N° 15 (OFF)	---	3.702E-5	8.675E-5	1.642E-4	1.840E-4	4.219E-4	3.952E-4	4.324E-4	5.821E-4	5.172E-4	2.195E-4
N° 16 (OFF)	---	4.183E-5	7.490E-5	1.486E-4	1.891E-4	4.247E-4	4.283E-4	4.585E-4	5.985E-4	5.355E-4	2.383E-4
Average (Bias1)	---	1.386E-5	4.447E-5	1.082E-4	1.510E-4	1.916E-4	2.105E-4	2.169E-4	2.495E-4	2.439E-4	9.770E-5
σ (Bias1)	---	1.038E-5	6.574E-6	5.286E-5	5.130E-5	4.280E-5	3.205E-5	3.327E-5	3.790E-5	4.607E-5	2.347E-5
Average+3σ (Bias1)	---	4.499E-5	6.419E-5	2.668E-4	3.049E-4	3.200E-4	3.066E-4	3.167E-4	3.632E-4	3.821E-4	1.681E-4
Average-3σ (Bias1)	---	-1.727E-5	2.474E-5	-5.034E-5	-2.880E-6	6.317E-5	1.143E-4	1.171E-4	1.358E-4	1.057E-4	2.728E-5
Average (Bias2)	---	2.895E-5	6.607E-5	1.401E-4	1.682E-4	3.417E-4	3.910E-4	4.231E-4	5.541E-4	5.237E-4	2.214E-4
σ (Bias2)	---	1.305E-5	9.977E-6	3.393E-5	3.903E-5	6.813E-5	6.826E-5	6.951E-5	1.018E-4	1.044E-4	2.937E-5
Average+3σ (Bias2)	---	6.810E-5	9.600E-5	2.419E-4	2.853E-4	5.461E-4	5.958E-4	6.316E-4	8.595E-4	8.368E-4	3.095E-4
Average-3σ (Bias2)	---	-1.021E-5	3.614E-5	3.835E-5	5.112E-5	1.373E-4	1.863E-4	2.146E-4	2.487E-4	2.106E-4	1.332E-4
Average (OFF)	---	3.499E-5	7.248E-5	1.324E-4	1.787E-4	3.579E-4	3.702E-4	3.974E-4	5.344E-4	4.739E-4	2.112E-4
σ (OFF)	---	7.966E-6	1.117E-5	2.361E-5	3.992E-5	6.316E-5	4.166E-5	4.611E-5	5.438E-5	5.105E-5	1.904E-5
Average+3σ (OFF)	---	5.889E-5	1.060E-4	2.032E-4	2.984E-4	5.474E-4	4.952E-4	5.357E-4	6.975E-4	6.270E-4	2.683E-4
Average-3σ (OFF)	---	1.109E-5	3.897E-5	6.153E-5	5.892E-5	1.684E-4	2.452E-4	2.591E-4	3.712E-4	3.207E-4	1.541E-4

17. CTR3

Ta=25°C; If = 1 mA; Vo = 0.4 V; Vcc = 5 V

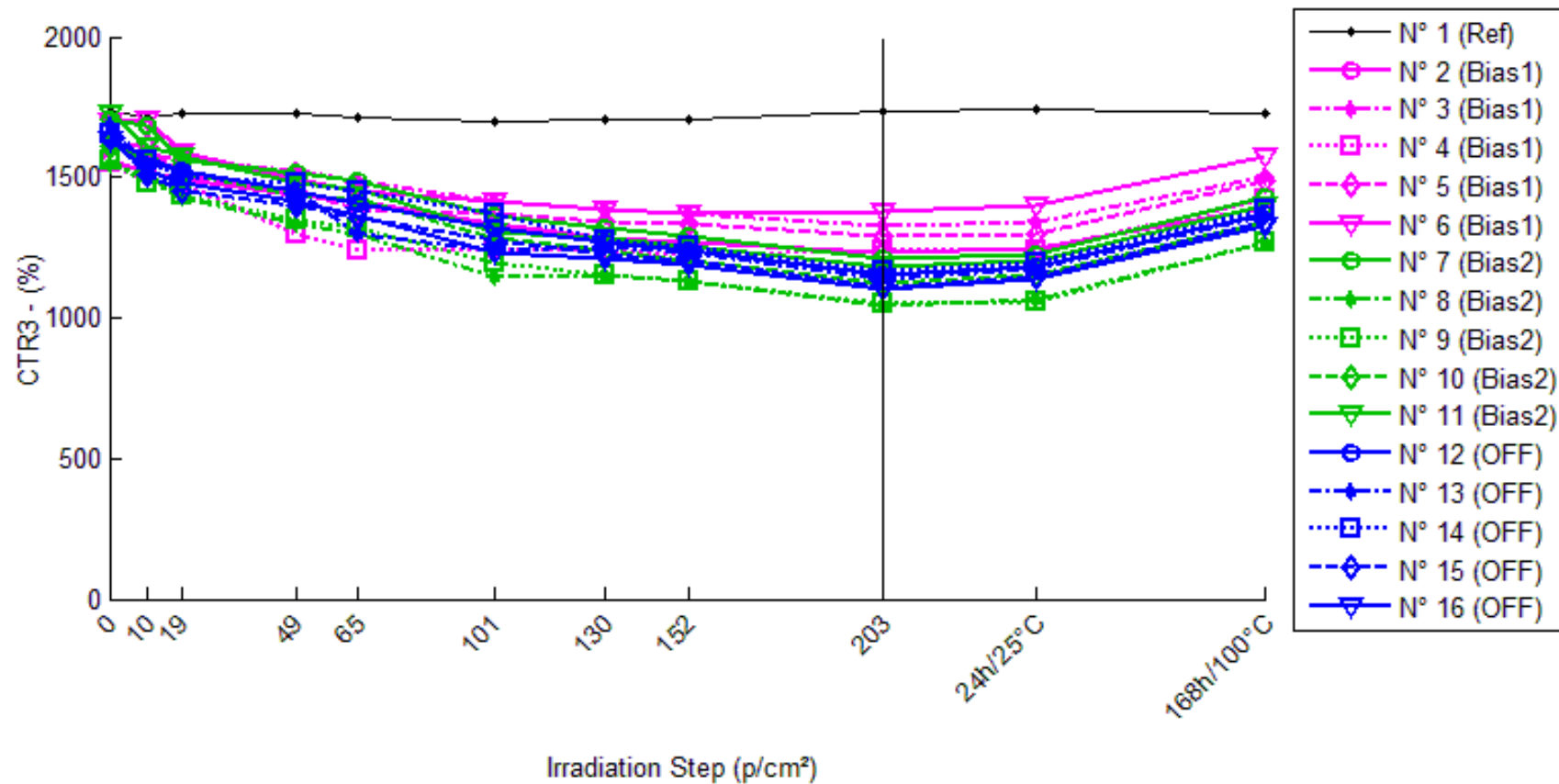

CTR3 . (%)

	0krad(Si)	10krad(Si)	19krad(Si)	49krad(Si)	65krad(Si)	101krad(Si)	130krad(Si)	152krad(Si)	203krad(Si)	24h/25°C	168h/100°C
N° 1 (Ref)	1734.56	1710.85	1728.46	1728.04	1711.73	1696.61	1702.18	1703.29	1737.01	1741.46	1729.73
N° 2 (Bias1)	1562.98	1514.37	1492.70	1435.40	1413.89	1331.96	1285.97	1272.08	1236.27	1246.41	1391.97
N° 3 (Bias1)	1619.41	1580.44	1560.14	1521.92	1487.63	1416.41	1384.04	1369.63	1329.51	1344.27	1500.20
N° 4 (Bias1)	1555.74	1482.46	1479.76	1297.70	1238.27	1246.67	1241.30	1228.77	1239.79	1239.00	1423.49
N° 5 (Bias1)	1613.39	1611.69	1511.35	1449.44	1384.75	1370.93	1345.13	1334.82	1294.25	1298.63	1485.49
N° 6 (Bias1)	1696.98	1703.19	1591.26	1493.74	1452.45	1412.91	1383.10	1371.55	1381.13	1398.81	1572.67
N° 7 (Bias2)	1706.30	1684.86	1559.03	1519.12	1489.14	1362.37	1317.62	1293.91	1211.90	1228.29	1432.29
N° 8 (Bias2)	1545.70	1507.26	1432.25	1331.22	1300.33	1144.73	1150.60	1130.51	1044.76	1066.39	1267.61
N° 9 (Bias2)	1558.92	1479.89	1437.58	1345.84	1321.99	1199.16	1152.58	1128.16	1048.91	1060.66	1272.45
N° 10 (Bias2)	1610.10	1563.76	1516.01	1434.53	1420.16	1280.08	1237.82	1206.21	1126.48	1151.26	1344.66
N° 11 (Bias2)	1726.83	1609.39	1576.69	1482.20	1460.46	1309.03	1286.89	1253.38	1184.62	1201.86	1396.59
N° 12 (OFF)	1641.88	1569.04	1527.09	1450.32	1404.36	1323.33	1265.71	1240.48	1153.58	1184.73	1370.48
N° 13 (OFF)	1680.93	1546.36	1526.26	1453.93	1299.05	1236.79	1252.63	1229.87	1139.26	1171.65	1364.42
N° 14 (OFF)	1651.82	1563.54	1502.20	1479.43	1452.41	1369.04	1274.26	1251.65	1164.61	1197.36	1388.30
N° 15 (OFF)	1638.61	1509.88	1449.70	1398.40	1358.80	1277.95	1227.74	1200.38	1110.88	1145.81	1340.26
N° 16 (OFF)	1634.08	1521.76	1477.28	1411.56	1365.37	1231.46	1208.39	1186.64	1100.70	1135.07	1324.65

1/Delta [CTR3]

	0krad(Si)	10krad(Si)	19krad(Si)	49krad(Si)	65krad(Si)	101krad(Si)	130krad(Si)	152krad(Si)	203krad(Si)	24h/25°C	168h/100°C
N° 1 (Ref)	---	7.988E-6	2.034E-6	2.175E-6	7.687E-6	1.290E-5	1.096E-5	1.058E-5	-8.138E-7	-2.287E-6	1.609E-6
N° 2 (Bias1)	---	2.054E-5	3.012E-5	5.687E-5	6.747E-5	1.110E-4	1.378E-4	1.463E-4	1.691E-4	1.625E-4	7.860E-5
N° 3 (Bias1)	---	1.523E-5	2.346E-5	3.956E-5	5.470E-5	8.850E-5	1.050E-4	1.126E-4	1.346E-4	1.264E-4	4.907E-5
N° 4 (Bias1)	---	3.177E-5	3.300E-5	1.278E-4	1.648E-4	1.594E-4	1.628E-4	1.710E-4	1.638E-4	1.643E-4	5.972E-5
N° 5 (Bias1)	---	6.530E-7	4.185E-5	7.011E-5	1.023E-4	1.096E-4	1.236E-4	1.294E-4	1.528E-4	1.502E-4	5.337E-5
N° 6 (Bias1)	---	-2.146E-6	3.915E-5	8.018E-5	9.921E-5	1.185E-4	1.337E-4	1.398E-4	1.348E-4	1.256E-4	4.658E-5
N° 7 (Bias2)	---	7.456E-6	5.536E-5	7.221E-5	8.546E-5	1.479E-4	1.729E-4	1.868E-4	2.391E-4	2.281E-4	1.121E-4
N° 8 (Bias2)	---	1.650E-5	5.125E-5	1.042E-4	1.221E-4	2.266E-4	2.222E-4	2.376E-4	3.102E-4	2.908E-4	1.419E-4
N° 9 (Bias2)	---	3.426E-5	5.415E-5	1.016E-4	1.150E-4	1.924E-4	2.262E-4	2.449E-4	3.119E-4	3.013E-4	1.444E-4
N° 10 (Bias2)	---	1.840E-5	3.855E-5	7.601E-5	8.307E-5	1.601E-4	1.868E-4	2.080E-4	2.666E-4	2.475E-4	1.226E-4
N° 11 (Bias2)	---	4.226E-5	5.515E-5	9.558E-5	1.056E-4	1.848E-4	1.980E-4	2.187E-4	2.651E-4	2.529E-4	1.369E-4
N° 12 (OFF)	---	2.828E-5	4.578E-5	8.045E-5	1.030E-4	1.466E-4	1.810E-4	1.971E-4	2.578E-4	2.350E-4	1.206E-4
N° 13 (OFF)	---	5.177E-5	6.029E-5	9.288E-5	1.749E-4	2.136E-4	2.034E-4	2.182E-4	2.829E-4	2.586E-4	1.380E-4
N° 14 (OFF)	---	3.418E-5	6.030E-5	7.054E-5	8.311E-5	1.250E-4	1.794E-4	1.936E-4	2.533E-4	2.298E-4	1.149E-4
N° 15 (OFF)	---	5.203E-5	7.952E-5	1.048E-4	1.257E-4	1.722E-4	2.042E-4	2.228E-4	2.899E-4	2.625E-4	1.359E-4
N° 16 (OFF)	---	4.517E-5	6.495E-5	9.647E-5	1.204E-4	2.001E-4	2.156E-4	2.307E-4	2.965E-4	2.690E-4	1.429E-4
Average (Bias1)	---	1.321E-5	3.352E-5	7.491E-5	9.770E-5	1.174E-4	1.326E-4	1.398E-4	1.510E-4	1.458E-4	5.747E-5
σ (Bias1)	---	1.411E-5	7.317E-6	3.326E-5	4.269E-5	2.597E-5	2.112E-5	2.160E-5	1.601E-5	1.888E-5	1.282E-5
Average+3σ (Bias1)	---	5.553E-5	5.547E-5	1.747E-4	2.258E-4	1.953E-4	1.960E-4	2.046E-4	1.991E-4	2.024E-4	9.594E-5
Average-3σ (Bias1)	---	-2.911E-5	1.157E-5	-2.488E-5	-3.036E-5	3.946E-5	6.924E-5	7.502E-5	1.030E-4	8.917E-5	1.900E-5
Average (Bias2)	---	2.377E-5	5.089E-5	8.992E-5	1.022E-4	1.824E-4	2.012E-4	2.192E-4	2.786E-4	2.641E-4	1.316E-4
σ (Bias2)	---	1.414E-5	7.092E-6	1.483E-5	1.744E-5	3.060E-5	2.281E-5	2.333E-5	3.160E-5	3.080E-5	1.378E-5
Average+3σ (Bias2)	---	6.619E-5	7.216E-5	1.344E-4	1.545E-4	2.742E-4	2.696E-4	2.892E-4	3.734E-4	3.565E-4	1.730E-4
Average-3σ (Bias2)	---	-1.864E-5	2.961E-5	4.544E-5	4.993E-5	9.060E-5	1.327E-4	1.492E-4	1.838E-4	1.717E-4	9.025E-5
Average (OFF)	---	4.229E-5	6.217E-5	8.903E-5	1.214E-4	1.715E-4	1.967E-4	2.125E-4	2.761E-4	2.510E-4	1.305E-4
σ (OFF)	---	1.067E-5	1.209E-5	1.356E-5	3.422E-5	3.664E-5	1.585E-5	1.634E-5	1.943E-5	1.747E-5	1.205E-5
Average+3σ (OFF)	---	7.429E-5	9.843E-5	1.297E-4	2.241E-4	2.814E-4	2.443E-4	2.615E-4	3.344E-4	3.034E-4	1.666E-4
Average-3σ (OFF)	---	1.028E-5	2.590E-5	4.836E-5	1.876E-5	6.160E-5	1.492E-4	1.634E-4	2.178E-4	1.986E-4	9.432E-5

18. CTR4

Ta=25°C; If = 5 mA; Vo = 0.4 V; Vcc = 5 V

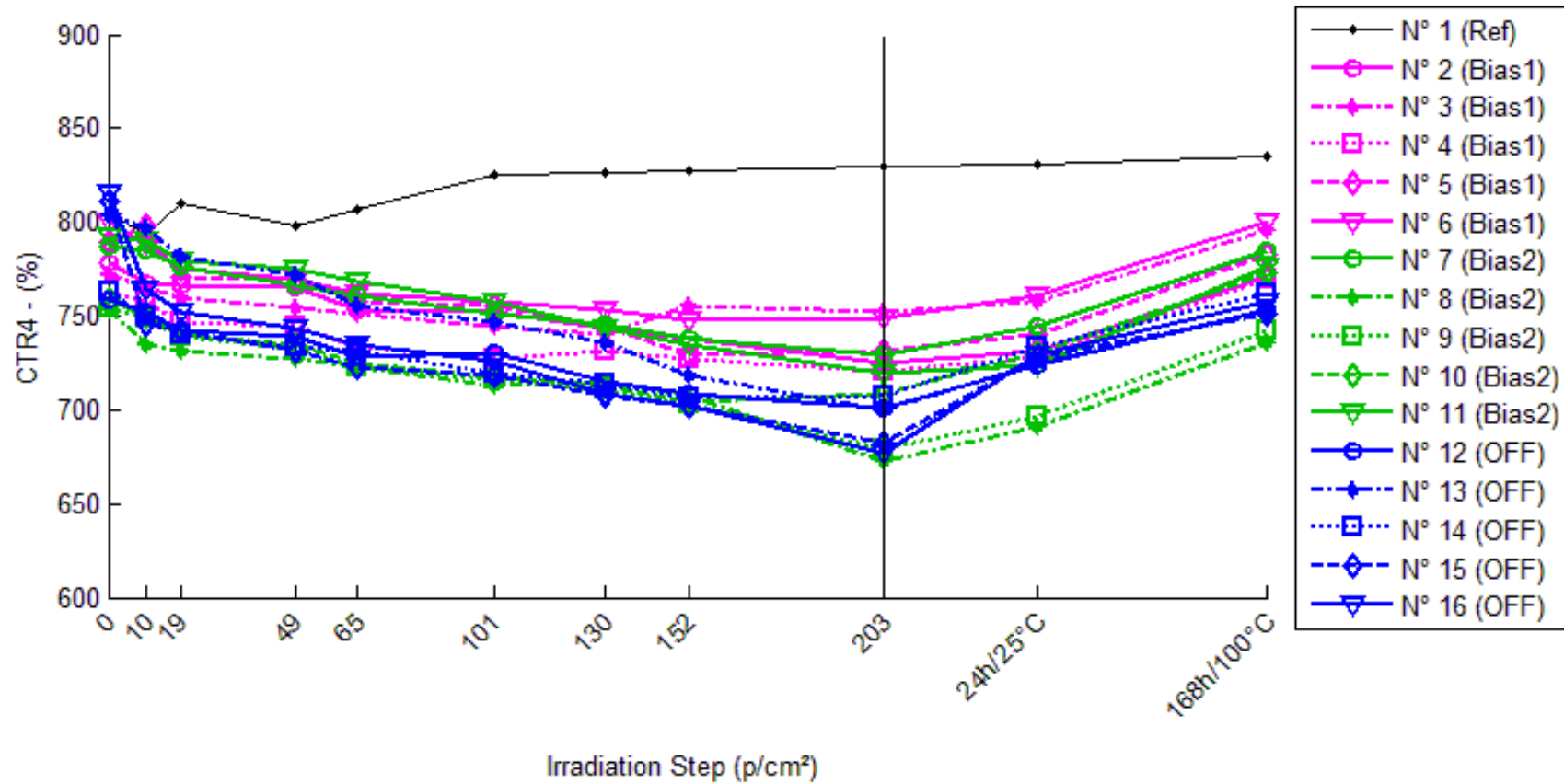

CTR4 . (%)

	0krad(Si)	10krad(Si)	19krad(Si)	49krad(Si)	65krad(Si)	101krad(Si)	130krad(Si)	152krad(Si)	203krad(Si)	24h/25°C	168h/100°C
N° 1 (Ref)	804.529	794.150	809.974	797.490	806.659	824.866	826.463	827.306	830.144	830.806	835.162
N° 2 (Bias1)	778.337	767.753	766.747	765.207	753.302	752.471	743.909	738.495	724.775	731.327	770.467
N° 3 (Bias1)	772.271	765.292	759.304	754.466	751.361	744.111	740.426	755.315	752.511	757.980	796.165
N° 4 (Bias1)	763.040	757.267	746.524	744.735	733.528	726.927	731.551	726.831	720.883	727.676	769.662
N° 5 (Bias1)	789.804	797.809	770.491	769.328	757.334	754.917	744.259	729.198	731.168	740.659	782.435
N° 6 (Bias1)	800.630	788.613	774.953	769.761	762.540	757.213	753.222	747.977	748.766	760.763	800.068
N° 7 (Bias2)	787.473	784.506	776.264	765.863	761.171	750.617	745.702	738.217	729.704	744.317	784.373
N° 8 (Bias2)	753.265	734.920	730.989	727.568	723.234	713.041	715.089	707.702	672.852	691.377	735.704
N° 9 (Bias2)	754.503	748.453	738.724	732.683	722.914	715.864	711.247	702.981	678.755	697.072	742.866
N° 10 (Bias2)	758.866	749.585	740.615	734.960	724.695	716.817	713.139	704.710	708.599	730.571	772.516
N° 11 (Bias2)	793.087	790.056	779.999	775.425	768.151	757.511	743.207	734.821	719.940	724.132	776.199
N° 12 (OFF)	758.644	752.639	742.799	738.717	727.976	730.511	714.749	708.024	701.084	724.051	753.422
N° 13 (OFF)	803.493	797.137	781.378	771.726	755.293	746.402	735.935	718.479	700.306	724.526	751.843
N° 14 (OFF)	763.282	750.234	740.544	733.097	731.027	719.845	713.524	706.496	707.180	733.992	762.210
N° 15 (OFF)	811.627	745.892	742.266	731.312	723.188	718.826	707.952	702.053	682.035	727.776	750.606
N° 16 (OFF)	815.860	764.230	752.358	743.797	734.460	725.992	708.800	702.194	677.133	729.236	757.859

1/Delta [CTR4]

	0krad(Si)	10krad(Si)	19krad(Si)	49krad(Si)	65krad(Si)	101krad(Si)	130krad(Si)	152krad(Si)	203krad(Si)	24h/25°C	168h/100°C
N° 1 (Ref)	---	1.624E-5	-8.357E-6	1.097E-5	-3.282E-6	-3.065E-5	-3.299E-5	-3.422E-5	-3.835E-5	-3.931E-5	-4.559E-5
N° 2 (Bias1)	---	1.771E-5	1.942E-5	2.205E-5	4.270E-5	4.416E-5	5.946E-5	6.931E-5	9.495E-5	8.259E-5	1.312E-5
N° 3 (Bias1)	---	1.181E-5	2.211E-5	3.056E-5	3.604E-5	4.900E-5	5.569E-5	2.907E-5	3.400E-5	2.441E-5	-3.886E-5
N° 4 (Bias1)	---	9.991E-6	2.899E-5	3.221E-5	5.273E-5	6.511E-5	5.641E-5	6.529E-5	7.664E-5	6.369E-5	-1.127E-5
N° 5 (Bias1)	---	-1.270E-5	3.174E-5	3.370E-5	5.428E-5	5.851E-5	7.748E-5	1.052E-4	1.015E-4	8.401E-5	1.192E-5
N° 6 (Bias1)	---	1.903E-5	4.139E-5	5.009E-5	6.239E-5	7.162E-5	7.861E-5	8.792E-5	8.651E-5	6.545E-5	8.783E-7
N° 7 (Bias2)	---	4.803E-6	1.834E-5	3.583E-5	4.388E-5	6.235E-5	7.113E-5	8.473E-5	1.005E-4	7.363E-5	5.018E-6
N° 8 (Bias2)	---	3.314E-5	4.046E-5	4.689E-5	5.512E-5	7.489E-5	7.087E-5	8.547E-5	1.587E-4	1.188E-4	3.169E-5
N° 9 (Bias2)	---	1.071E-5	2.831E-5	3.947E-5	5.792E-5	7.154E-5	8.061E-5	9.714E-5	1.479E-4	1.092E-4	2.076E-5
N° 10 (Bias2)	---	1.632E-5	3.247E-5	4.286E-5	6.214E-5	7.730E-5	8.450E-5	1.013E-4	9.348E-5	5.104E-5	-2.328E-5
N° 11 (Bias2)	---	4.837E-6	2.116E-5	2.872E-5	4.093E-5	5.922E-5	8.463E-5	9.998E-5	1.281E-4	1.201E-4	2.743E-5
N° 12 (OFF)	---	1.052E-5	2.812E-5	3.556E-5	5.553E-5	5.076E-5	8.095E-5	9.424E-5	1.082E-4	6.298E-5	9.137E-6
N° 13 (OFF)	---	9.923E-6	3.522E-5	5.123E-5	7.942E-5	9.520E-5	1.142E-4	1.473E-4	1.834E-4	1.356E-4	8.550E-5
N° 14 (OFF)	---	2.279E-5	4.023E-5	5.394E-5	5.781E-5	7.906E-5	9.136E-5	1.053E-4	1.039E-4	5.228E-5	1.843E-6
N° 15 (OFF)	---	1.086E-4	1.151E-4	1.353E-4	1.507E-4	1.591E-4	1.804E-4	1.923E-4	2.341E-4	1.420E-4	1.002E-4
N° 16 (OFF)	---	8.281E-5	1.035E-4	1.188E-4	1.358E-4	1.517E-4	1.851E-4	1.984E-4	2.511E-4	1.456E-4	9.381E-5
Average (Bias1)	---	9.168E-6	2.873E-5	3.372E-5	4.963E-5	5.768E-5	6.553E-5	7.137E-5	7.873E-5	6.403E-5	-4.842E-6
σ (Bias1)	---	1.281E-5	8.656E-6	1.020E-5	1.033E-5	1.127E-5	1.152E-5	2.851E-5	2.669E-5	2.406E-5	2.142E-5
Average+3σ (Bias1)	---	4.760E-5	5.470E-5	6.433E-5	8.062E-5	9.149E-5	1.001E-4	1.569E-4	1.588E-4	1.362E-4	5.942E-5
Average-3σ (Bias1)	---	-2.926E-5	2.761E-6	3.108E-6	1.863E-5	2.387E-5	3.097E-5	-1.416E-5	-1.331E-6	-8.143E-6	-6.910E-5
Average (Bias2)	---	1.396E-5	2.815E-5	3.875E-5	5.200E-5	6.906E-5	7.835E-5	9.372E-5	1.257E-4	9.455E-5	1.232E-5
σ (Bias2)	---	1.174E-5	8.879E-6	6.942E-6	9.164E-6	7.905E-6	6.896E-6	8.011E-6	2.853E-5	3.077E-5	2.234E-5
Average+3σ (Bias2)	---	4.917E-5	5.478E-5	5.958E-5	7.949E-5	9.277E-5	9.903E-5	1.178E-4	2.113E-4	1.869E-4	7.933E-5
Average-3σ (Bias2)	---	-2.125E-5	1.509E-6	1.793E-5	2.450E-5	4.534E-5	5.766E-5	6.968E-5	4.014E-5	2.250E-6	-5.469E-5
Average (OFF)	---	4.692E-5	6.443E-5	7.896E-5	9.586E-5	1.072E-4	1.304E-4	1.475E-4	1.762E-4	1.077E-4	5.809E-5
σ (OFF)	---	4.573E-5	4.138E-5	4.483E-5	4.458E-5	4.689E-5	4.932E-5	4.800E-5	6.867E-5	4.599E-5	4.837E-5
Average+3σ (OFF)	---	1.841E-4	1.886E-4	2.134E-4	2.296E-4	2.478E-4	2.784E-4	2.915E-4	3.821E-4	2.457E-4	2.032E-4
Average-3σ (OFF)	---	-9.028E-5	-5.972E-5	-5.552E-5	-3.787E-5	-3.350E-5	-1.753E-5	3.504E-6	-2.985E-5	-3.029E-5	-8.701E-5

19. CTR5

Ta=25°C; If = 10 mA; Vo = 0.4 V; Vcc = 5 V

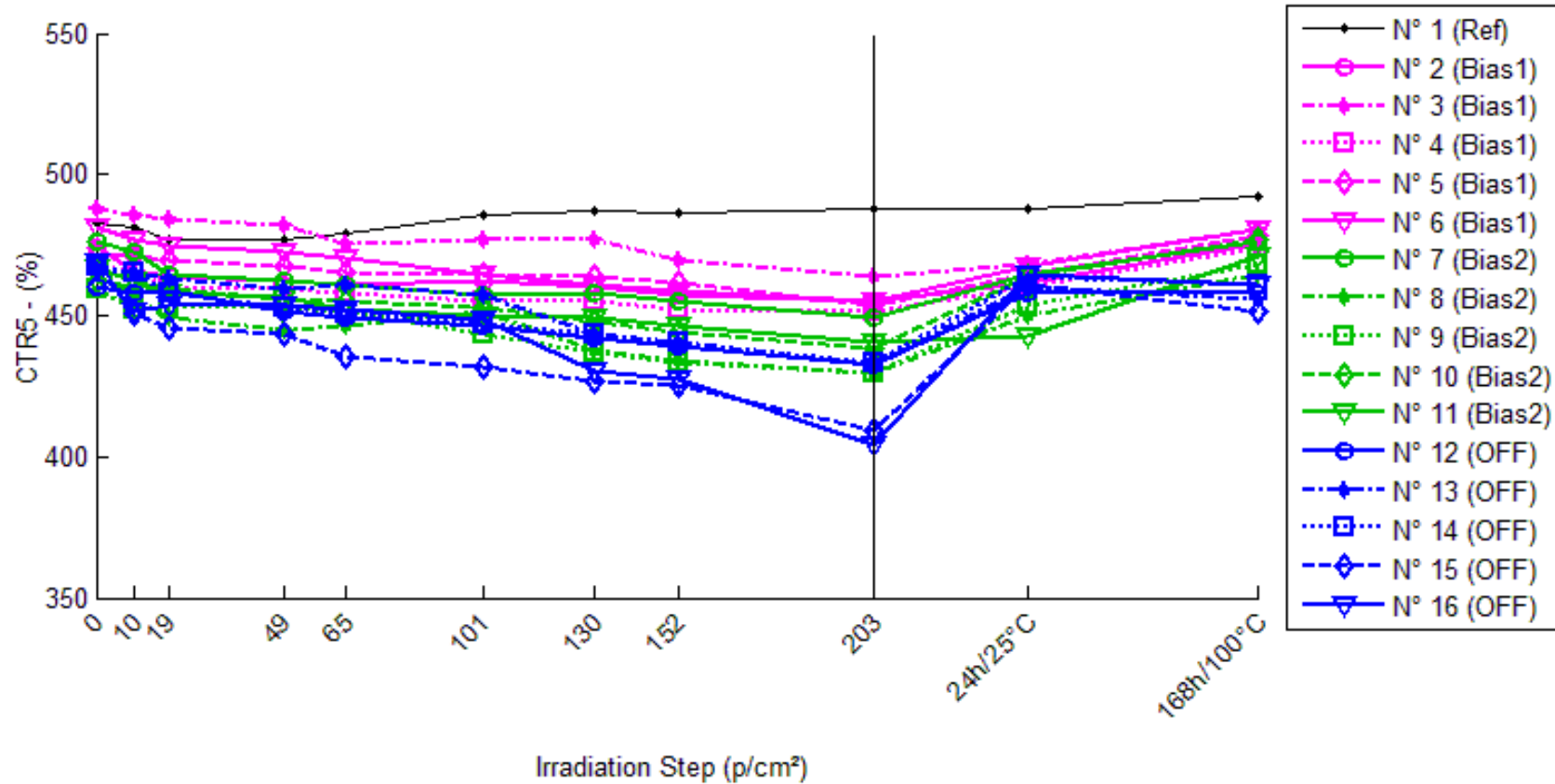

CTR5 . (%)

	0krad(Si)	10krad(Si)	19krad(Si)	49krad(Si)	65krad(Si)	101krad(Si)	130krad(Si)	152krad(Si)	203krad(Si)	24h/25°C	168h/100°C
N° 1 (Ref)	482.382	481.362	476.997	476.861	479.096	485.668	487.138	486.534	487.493	487.461	492.439
N° 2 (Bias1)	474.006	466.191	463.683	462.594	460.581	462.291	460.336	457.545	455.197	461.346	475.423
N° 3 (Bias1)	487.772	485.988	484.171	482.330	475.367	476.732	477.258	469.660	464.108	468.324	480.684
N° 4 (Bias1)	468.307	464.965	460.464	459.539	458.068	455.349	454.965	452.489	451.789	460.034	473.971
N° 5 (Bias1)	471.893	471.189	469.998	467.528	464.939	464.674	463.958	461.560	453.570	464.302	478.006
N° 6 (Bias1)	481.515	476.654	474.510	472.184	470.049	464.615	461.168	458.594	455.116	467.606	480.527
N° 7 (Bias2)	475.858	472.826	464.451	462.384	460.912	457.234	458.012	454.887	449.017	464.286	476.388
N° 8 (Bias2)	467.272	455.848	449.319	445.054	446.590	451.646	437.532	434.292	429.771	450.298	464.733
N° 9 (Bias2)	459.560	452.476	453.019	453.260	451.483	443.187	436.569	433.089	429.993	453.745	468.225
N° 10 (Bias2)	462.688	459.858	459.447	456.131	455.052	452.554	447.490	444.013	438.709	463.761	476.981
N° 11 (Bias2)	466.516	462.489	457.694	456.300	452.434	450.188	449.576	446.092	440.321	443.076	470.837
N° 12 (OFF)	460.095	458.086	459.006	451.366	448.925	446.487	441.717	438.782	432.278	457.937	457.887
N° 13 (OFF)	466.204	465.095	462.772	459.467	460.571	456.976	443.596	440.471	432.766	460.046	455.476
N° 14 (OFF)	467.807	465.242	458.163	452.619	450.729	447.305	443.722	440.668	433.364	463.706	460.895
N° 15 (OFF)	467.655	450.687	445.321	443.213	435.452	431.885	426.951	425.620	409.342	461.013	451.344
N° 16 (OFF)	468.574	451.172	453.320	453.719	452.283	448.904	430.218	427.628	404.426	464.239	460.736

1/Delta [CTR5]

	0krad(Si)	10krad(Si)	19krad(Si)	49krad(Si)	65krad(Si)	101krad(Si)	130krad(Si)	152krad(Si)	203krad(Si)	24h/25°C	168h/100°C
N° 1 (Ref)	---	4.394E-6	2.341E-5	2.400E-5	1.422E-5	-1.402E-5	-2.024E-5	-1.769E-5	-2.173E-5	-2.160E-5	-4.234E-5
N° 2 (Bias1)	---	3.536E-5	4.696E-5	5.204E-5	6.149E-5	5.346E-5	6.265E-5	7.590E-5	8.717E-5	5.789E-5	-6.291E-6
N° 3 (Bias1)	---	7.524E-6	1.525E-5	2.313E-5	5.350E-5	4.748E-5	4.516E-5	7.906E-5	1.045E-4	8.514E-5	3.023E-5
N° 4 (Bias1)	---	1.535E-5	3.637E-5	4.074E-5	4.773E-5	6.077E-5	6.262E-5	7.465E-5	7.807E-5	3.840E-5	-2.552E-5
N° 5 (Bias1)	---	3.168E-6	8.548E-6	1.978E-5	3.170E-5	3.292E-5	3.625E-5	4.744E-5	8.561E-5	3.465E-5	-2.710E-5
N° 6 (Bias1)	---	2.118E-5	3.066E-5	4.104E-5	5.066E-5	7.554E-5	9.163E-5	1.038E-4	1.205E-4	6.177E-5	4.268E-6
N° 7 (Bias2)	---	1.348E-5	5.161E-5	6.124E-5	6.814E-5	8.559E-5	8.188E-5	9.688E-5	1.256E-4	5.238E-5	-2.341E-6
N° 8 (Bias2)	---	5.364E-5	8.551E-5	1.068E-4	9.911E-5	7.404E-5	1.455E-4	1.625E-4	1.867E-4	8.067E-5	1.169E-5
N° 9 (Bias2)	---	3.407E-5	3.142E-5	3.024E-5	3.893E-5	8.039E-5	1.146E-4	1.330E-4	1.496E-4	2.789E-5	-4.027E-5
N° 10 (Bias2)	---	1.330E-5	1.524E-5	3.107E-5	3.627E-5	4.840E-5	7.340E-5	9.090E-5	1.181E-4	-5.001E-6	-6.477E-5
N° 11 (Bias2)	---	1.866E-5	4.131E-5	4.799E-5	6.671E-5	7.774E-5	8.076E-5	9.814E-5	1.275E-4	1.134E-4	-1.967E-5
N° 12 (OFF)	---	9.532E-6	5.158E-6	4.203E-5	5.408E-5	6.624E-5	9.043E-5	1.056E-4	1.399E-4	1.024E-5	1.048E-5
N° 13 (OFF)	---	5.113E-6	1.591E-5	3.145E-5	2.624E-5	4.332E-5	1.093E-4	1.253E-4	1.657E-4	2.871E-5	5.052E-5
N° 14 (OFF)	---	1.178E-5	4.499E-5	7.173E-5	8.099E-5	9.798E-5	1.160E-4	1.316E-4	1.699E-4	1.890E-5	3.206E-5
N° 15 (OFF)	---	8.051E-5	1.072E-4	1.179E-4	1.581E-4	1.771E-4	2.039E-4	2.112E-4	3.046E-4	3.081E-5	7.727E-5
N° 16 (OFF)	---	8.232E-5	7.181E-5	6.987E-5	7.687E-5	9.351E-5	1.903E-4	2.043E-4	3.385E-4	1.992E-5	3.630E-5
Average (Bias1)	---	1.652E-5	2.756E-5	3.535E-5	4.901E-5	5.403E-5	5.966E-5	7.617E-5	9.517E-5	5.557E-5	-4.882E-6
σ (Bias1)	---	1.262E-5	1.563E-5	1.352E-5	1.095E-5	1.579E-5	2.120E-5	2.000E-5	1.714E-5	2.031E-5	2.365E-5
Average+3σ (Bias1)	---	5.438E-5	7.444E-5	7.592E-5	8.188E-5	1.014E-4	1.233E-4	1.362E-4	1.466E-4	1.165E-4	6.608E-5
Average-3σ (Bias1)	---	-2.135E-5	-1.932E-5	-5.225E-6	1.615E-5	6.674E-6	-3.943E-6	1.618E-5	4.375E-5	-5.374E-6	-7.585E-5
Average (Bias2)	---	2.663E-5	4.502E-5	5.547E-5	6.183E-5	7.323E-5	9.922E-5	1.163E-4	1.415E-4	5.387E-5	-2.307E-5
σ (Bias2)	---	1.731E-5	2.631E-5	3.146E-5	2.565E-5	1.451E-5	3.034E-5	3.069E-5	2.787E-5	4.584E-5	3.035E-5
Average+3σ (Bias2)	---	7.856E-5	1.239E-4	1.499E-4	1.388E-4	1.168E-4	1.903E-4	2.083E-4	2.251E-4	1.914E-4	6.797E-5
Average-3σ (Bias2)	---	-2.531E-5	-3.390E-5	-3.892E-5	-1.512E-5	2.971E-5	8.187E-6	2.423E-5	5.792E-5	-8.365E-5	-1.141E-4
Average (OFF)	---	3.785E-5	4.902E-5	6.660E-5	7.926E-5	9.563E-5	1.420E-4	1.556E-4	2.237E-4	2.172E-5	4.133E-5
σ (OFF)	---	3.984E-5	4.167E-5	3.358E-5	4.918E-5	5.062E-5	5.138E-5	4.863E-5	9.084E-5	8.282E-6	2.469E-5
Average+3σ (OFF)	---	1.574E-4	1.740E-4	1.673E-4	2.268E-4	2.475E-4	2.961E-4	3.015E-4	4.963E-4	4.656E-5	1.154E-4
Average-3σ (OFF)	---	-8.168E-5	-7.599E-5	-3.414E-5	-6.828E-5	-5.622E-5	-1.215E-5	9.723E-6	-4.881E-5	-3.126E-6	-3.276E-5

20. CTR6

Ta=25°C; If = 5 mA; Vo = 0.4 V; Vcc = 18 V

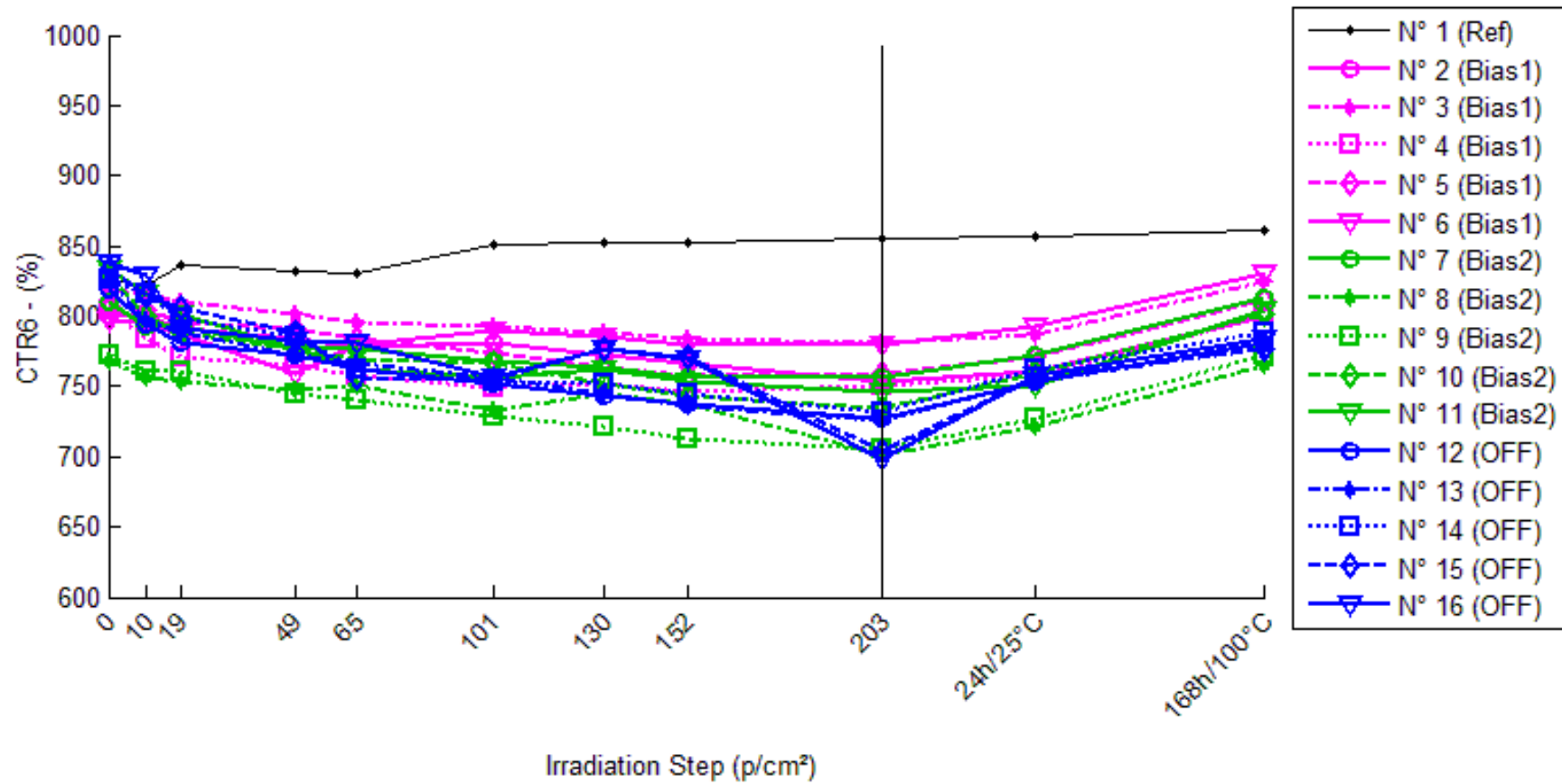

CTR6 . (%)

	0krad(Si)	10krad(Si)	19krad(Si)	49krad(Si)	65krad(Si)	101krad(Si)	130krad(Si)	152krad(Si)	203krad(Si)	24h/25°C	168h/100°C
N° 1 (Ref)	826.198	821.355	835.871	832.037	831.077	850.679	852.544	852.960	855.956	856.421	861.754
N° 2 (Bias1)	799.318	800.276	791.606	783.839	778.561	781.072	772.755	767.189	753.327	760.604	799.475
N° 3 (Bias1)	818.866	816.446	810.893	801.761	795.862	792.097	788.863	783.543	780.702	786.607	824.035
N° 4 (Bias1)	804.771	783.850	770.220	765.210	757.402	749.562	751.448	746.493	749.911	757.789	799.329
N° 5 (Bias1)	807.065	804.164	796.089	790.995	783.859	773.867	763.504	758.180	759.396	770.226	811.344
N° 6 (Bias1)	796.843	795.591	786.940	759.587	779.781	790.324	784.776	779.350	778.939	792.727	831.007
N° 7 (Bias2)	809.730	793.155	792.573	776.777	776.488	768.487	763.943	756.476	756.892	773.020	812.709
N° 8 (Bias2)	768.242	756.969	753.832	746.950	750.584	733.154	744.339	737.249	700.460	720.771	765.313
N° 9 (Bias2)	772.501	761.184	760.752	744.179	740.611	729.143	720.784	712.418	705.937	726.676	772.722
N° 10 (Bias2)	829.358	799.421	788.109	776.122	769.694	766.122	751.533	743.066	734.618	759.475	801.350
N° 11 (Bias2)	833.531	816.091	801.231	776.516	762.105	755.704	761.691	753.176	745.465	749.829	803.668
N° 12 (OFF)	819.275	794.635	781.461	772.888	762.272	751.588	743.825	736.906	727.421	753.446	780.848
N° 13 (OFF)	824.181	796.667	788.429	772.584	765.905	755.911	744.248	736.716	726.006	753.235	778.047
N° 14 (OFF)	826.193	816.492	798.858	784.783	761.929	753.563	751.648	744.570	732.250	762.669	788.496
N° 15 (OFF)	833.444	814.401	806.101	788.410	756.321	755.498	776.159	770.443	704.082	756.540	776.180
N° 16 (OFF)	837.673	828.689	791.629	781.975	780.958	755.962	776.857	770.111	697.789	757.750	784.054

1/Delta [CTR6]

	0krad(Si)	10krad(Si)	19krad(Si)	49krad(Si)	65krad(Si)	101krad(Si)	130krad(Si)	152krad(Si)	203krad(Si)	24h/25°C	168h/100°C
N° 1 (Ref)	---	7.136E-6	-1.401E-5	-8.493E-6	-7.105E-6	-3.483E-5	-3.740E-5	-3.798E-5	-4.208E-5	-4.271E-5	-4.994E-5
N° 2 (Bias1)	---	-1.499E-6	1.219E-5	2.470E-5	3.335E-5	2.923E-5	4.300E-5	5.239E-5	7.638E-5	6.368E-5	-2.469E-7
N° 3 (Bias1)	---	3.621E-6	1.201E-5	2.605E-5	3.530E-5	4.127E-5	4.645E-5	5.505E-5	5.970E-5	5.008E-5	-7.661E-6
N° 4 (Bias1)	---	3.317E-5	5.574E-5	6.424E-5	7.771E-5	9.152E-5	8.817E-5	9.701E-5	9.090E-5	7.704E-5	8.459E-6
N° 5 (Bias1)	---	4.470E-6	1.708E-5	2.517E-5	3.668E-5	5.315E-5	7.069E-5	7.989E-5	7.778E-5	5.926E-5	-6.536E-6
N° 6 (Bias1)	---	1.975E-6	1.579E-5	6.155E-5	2.746E-5	1.035E-5	1.930E-5	2.817E-5	2.885E-5	6.515E-6	-5.159E-5
N° 7 (Bias2)	---	2.581E-5	2.673E-5	5.239E-5	5.287E-5	6.628E-5	7.402E-5	8.694E-5	8.621E-5	5.865E-5	-4.527E-6
N° 8 (Bias2)	---	1.938E-5	2.488E-5	3.710E-5	3.062E-5	6.230E-5	4.180E-5	5.472E-5	1.260E-4	8.573E-5	4.982E-6
N° 9 (Bias2)	---	1.925E-5	1.999E-5	4.927E-5	5.574E-5	7.698E-5	9.288E-5	1.092E-4	1.221E-4	8.163E-5	-3.689E-7
N° 10 (Bias2)	---	4.515E-5	6.311E-5	8.270E-5	9.347E-5	9.952E-5	1.249E-4	1.400E-4	1.555E-4	1.109E-4	4.214E-5
N° 11 (Bias2)	---	2.564E-5	4.836E-5	8.809E-5	1.124E-4	1.236E-4	1.132E-4	1.280E-4	1.417E-4	1.339E-4	4.458E-5
N° 12 (OFF)	---	3.785E-5	5.906E-5	7.326E-5	9.128E-5	1.099E-4	1.238E-4	1.364E-4	1.541E-4	1.066E-4	6.007E-5
N° 13 (OFF)	---	4.190E-5	5.502E-5	8.103E-5	9.232E-5	1.096E-4	1.303E-4	1.440E-4	1.641E-4	1.143E-4	7.194E-5
N° 14 (OFF)	---	1.438E-5	4.142E-5	6.387E-5	1.021E-4	1.167E-4	1.200E-4	1.327E-4	1.553E-4	1.008E-4	5.787E-5
N° 15 (OFF)	---	2.806E-5	4.070E-5	6.853E-5	1.224E-4	1.238E-4	8.856E-5	9.811E-5	2.204E-4	1.220E-4	8.852E-5
N° 16 (OFF)	---	1.294E-5	6.944E-5	8.503E-5	8.670E-5	1.290E-4	9.346E-5	1.047E-4	2.393E-4	1.259E-4	8.164E-5
Average (Bias1)	---	8.346E-6	2.256E-5	4.034E-5	4.210E-5	4.510E-5	5.352E-5	6.250E-5	6.672E-5	5.132E-5	-1.152E-5
σ (Bias1)	---	1.406E-5	1.868E-5	2.062E-5	2.022E-5	3.039E-5	2.659E-5	2.660E-5	2.390E-5	2.686E-5	2.330E-5
Average+3σ (Bias1)	---	5.053E-5	7.860E-5	1.022E-4	1.028E-4	1.363E-4	1.333E-4	1.423E-4	1.384E-4	1.319E-4	5.839E-5
Average-3σ (Bias1)	---	-3.384E-5	-3.348E-5	-2.150E-5	-1.855E-5	-4.607E-5	-2.624E-5	-1.729E-5	-4.969E-6	-2.927E-5	-8.142E-5
Average (Bias2)	---	2.705E-5	3.662E-5	6.191E-5	6.903E-5	8.573E-5	8.934E-5	1.038E-4	1.263E-4	9.418E-5	1.736E-5
σ (Bias2)	---	1.062E-5	1.838E-5	2.227E-5	3.315E-5	2.562E-5	3.292E-5	3.398E-5	2.606E-5	2.895E-5	2.399E-5
Average+3σ (Bias2)	---	5.890E-5	9.176E-5	1.287E-4	1.685E-4	1.626E-4	1.881E-4	2.057E-4	2.045E-4	1.810E-4	8.932E-5
Average-3σ (Bias2)	---	-4.805E-6	-1.853E-5	-4.893E-6	-3.041E-5	8.873E-6	-9.431E-6	1.822E-6	4.812E-5	7.332E-6	-5.460E-5
Average (OFF)	---	2.703E-5	5.313E-5	7.434E-5	9.895E-5	1.178E-4	1.112E-4	1.232E-4	1.866E-4	1.139E-4	7.201E-5
σ (OFF)	---	1.321E-5	1.221E-5	8.712E-6	1.423E-5	8.559E-6	1.891E-5	2.043E-5	4.021E-5	1.041E-5	1.330E-5
Average+3σ (OFF)	---	6.665E-5	8.976E-5	1.005E-4	1.416E-4	1.435E-4	1.680E-4	1.845E-4	3.073E-4	1.452E-4	1.119E-4
Average-3σ (OFF)	---	-1.260E-5	1.650E-5	4.821E-5	5.624E-5	9.212E-5	5.451E-5	6.190E-5	6.602E-5	8.269E-5	3.209E-5