

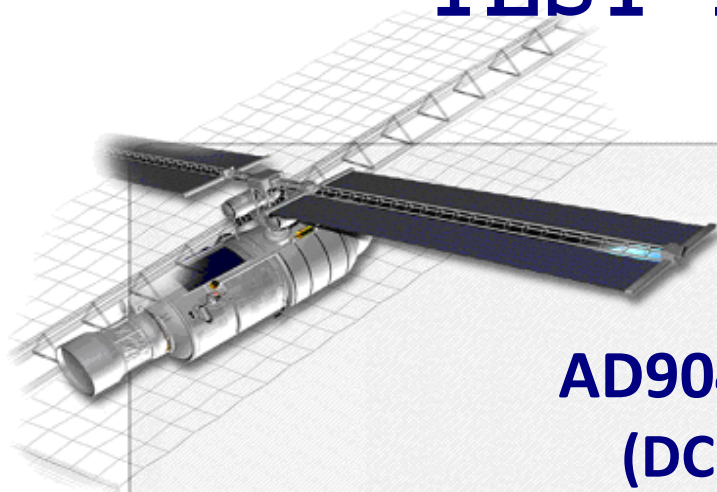

TOTAL IONIZING DOSE TEST REPORT

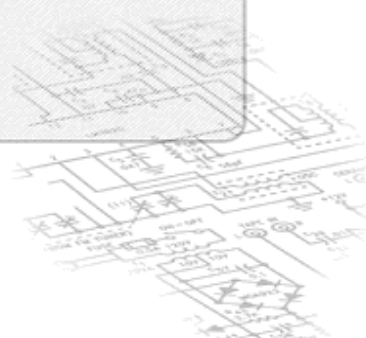

AD9042ASTZ (DC1314) 12-Bit, 41 MSPS Monolithic A/D Converter From Analog Devices



TRAD/TE/AD9042ASTZ/1314/ESA/LG/1409		Labège, 24 June 2015
 		TRAD, Bât Gallium 907, Voie l'Occitane - 31670 LABEGE France ☎ : 05 61 00 95 60 Fax: 05 61 00 95 61 Email: trad@trad.fr Web Site: www.trad.fr SIRET 397 862 038 00056 - TVA FR59397862038
Written by	Verified by / Quality control	Approved by
L. SALVY 15/07/2015	L. GOUYET 15/07/2015	A. ROUSSET 15/07/2015
Revision: 0		
To: ESA Marc POIZAT	Project/Program: Ref:	

CONTENTS

1. Introduction.....	3
2. Documents	3
2.1. Applicable documents	3
2.2. Reference documents.....	3
3. Part information	3
3.1. Identification.....	3
3.2. Procurement information	3
3.3. Sample pictures.....	4
3.3.1. External view	4
3.3.2. Internal view	4
4. Dosimetry and irradiation facility.....	5
4.1. Irradiation facility.....	5
4.2. Irradiation time log	5
5. Bias setup	6
5.1. Parts distribution	6
5.2. Bias condition.....	6
5.3. Bias equipment identification	6
6. Test setup	7
6.1. Test parameters.....	7
6.2. Test equipment identification.....	7
7. Non conformance.....	7
8. Results	8
8.1. Presentation of the results	8
8.1.1. Technical comments.....	8
9. Conclusion	9
10. Appendix 1 measured parameters.....	10

FIGURES

Figure 1: Package marking.....	4
Figure 2: Internal overall view	4
Figure 3: Die marking	4
Figure 4: Bias Condition.....	6

1. INTRODUCTION

This report describes the testing and characterization of the **AD9042ASTZ** manufactured by **Analog Devices**. Irradiations began on 23 January 2015 and ended on 21 April 2015.

2. DOCUMENTS

2.1. Applicable documents

- Financial and technical proposal: TRAD/P/ESA/AO7751/AV/130214 Rev.0
- Irradiation test plan: ITP/TRA/TE/AD9042/XXX/AD/300714

2.2. Reference documents

- Basic specification: ESCC N°22900 Issue 4 of October 2010
- Data-sheet: AD9042 Datasheet from Analog Devices rev B 10/2009.

3. PART INFORMATION

3.1. Identification

Part designation	AD9042ASTZ
Manufacturer	Analog Devices
Part function	12-Bit, 41 MSPS Monolithic A/D Converter

3.2. Procurement information

Package	QFP-44
Date code	1314
Number of tested parts	10 irradiated samples + 1 reference sample

3.3. Sample pictures

3.3.1. External view



Figure 1: Package marking

3.3.2. Internal view

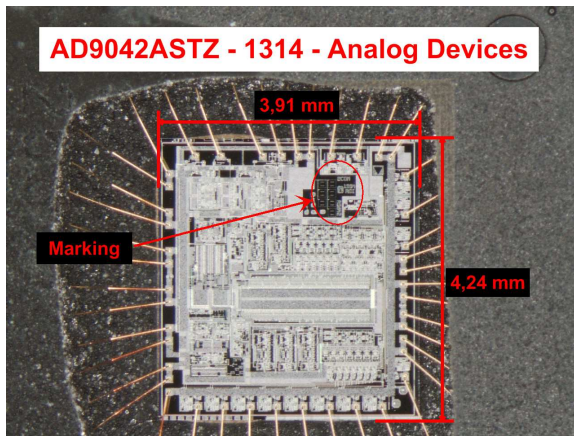

Figure 2: Internal overall view

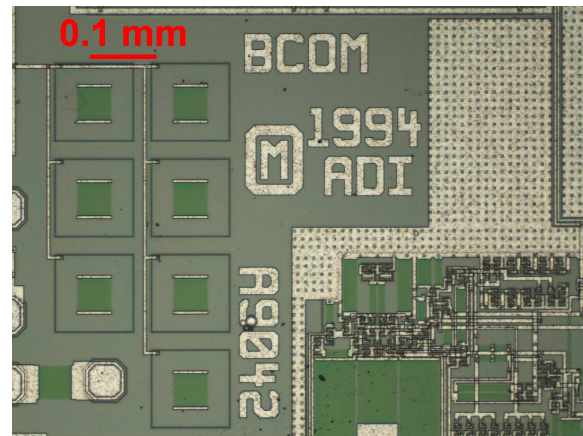

Figure 3: Die marking

4. DOSIMETRY AND IRRADIATION FACILITY

4.1. Irradiation facility

Irradiation source	⁶⁰ Co
Source location	U.C.L (Louvain-la-Neuve)
Irradiation equipment	GIF
Dosimetry equipment	PTW Ionization chamber

4.2. Irradiation time log

Total dose limit (krad(Si))	150				
Levels for measurements (krad(Si))	0	42	78	114	150
Dose rate (rad(Si)/h)	74				

5. BIAS SETUP

All irradiated components are biased under the following conditions. One component is not irradiated to act as a *REFERENCE*. All the parameters specified in the applicable ITP are measured on the *REFERENCE* and irradiated components.

5.1. Parts distribution

Serial number	Reference	Samples irradiated										
		2	3	4	5	6	7	8	9	10	11	
TRAD mark	1											
Bias mode	REF	ON	ON	ON	ON	ON	OFF	OFF	OFF	OFF	OFF	OFF

5.2. Bias condition

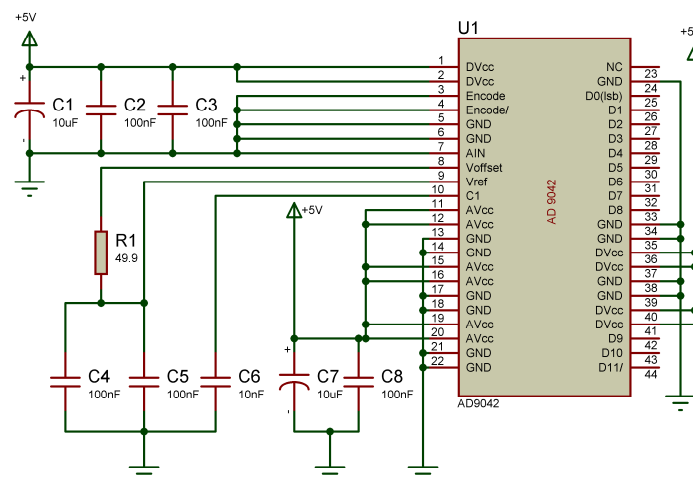

Figure 4: Bias Condition

5.3. Bias equipment identification

Bias board	TRAD/CP1/R/AD9042/ZIP28/LS/1407
Equipment	AR-69

6. TEST SETUP

6.1. Test parameters

Parameters	Symbols	Test conditions
Ta = +25°C, AVcc = DVcc = +5V, Vref tied to Voffset through 50Ω, unless otherwise specified		
Offset Error	Offset_Error	
Gain Error	Gain_Error	
Input Resistance	Rin	
Reference Out	Vref	
Logic 1 Input Voltage	Vih	
Logic 0 Input Voltage	Vil	
Logic 1 Input Current	Iih	Vinh = 5V
Logic 0 Input Current	Iil	Vinl = 0V
Logic 1 Output Voltage	Voh	Ioh = 10μA
Logic 0 Output Voltage	Vol	Iol = 10μA
DVcc Supply Current	ICCD	
AVcc Supply Current	ICCA	
Total Supply Current	ICC_TOTAL	
Output Delay	Tod	ENCODE = 41 MSPS
Signal to Noise Ratio	SNR	ENCODE = 41 MSPS, Analog input at -1dBFS, F = 9.6MHz
Signal to Noise And Distortion Ratio	SINAD	
Worst Spur Ratio	WS	
Differential Non Linearity	DNL	ENCODE = 20MSPS
Integral Non Linearity	INL	

6.2. Test equipment identification

Test board	TRAD/CT1/E/AD9042/DIL28/YP/1101 TRAD/CT3/E/AD9042/DIL28/BV/1102
Equipment	MI-56, MI-54, MI-51, MI-50, MI-15, MI-08, ME-04, GR-28, SM-52, SM-21
Test program	AD9042_TE_XXX1_B2_V10 to V30

7. NON CONFORMANCE

Test and measurement conditions were nominal.

8. RESULTS

8.1. Presentation of the results

For each parameter:

- The measurements performed at each irradiation step are registered in a table.
- Drifts between each measurement step and the "0" krad(Si) step are computed.

NB : * For the **CTR** and the **Hfe** parameters, the formula used is :

$$Drift = \frac{1}{measurement(Xkrad(Si))} - \frac{1}{measurement(0krad(Si))}$$

* For the **other measurements**, the formula used is:

$$Drift = measurement(Xkrad(Si)) - measurement(0krad(Si))$$

Where X stands for each measurement step.

8.1.1. Technical comments

No atypical behaviour during the test to report.

9. CONCLUSION

The total dose steady-state irradiation test using gamma rays from Cobalt 60 source has been carried out on **10 AD9042ASTZ**, a **12-Bit, 41 MSPS Monolithic A/D Converter** from **Analog Devices** up to **150 krad(Si)** at low dose rate (74 rad(Si)/h).

Hereunder our comments:

No failure observed on the DUTs at total dose level.

10. APPENDIX 1 MEASURED PARAMETERS

Contents :

1	Offset_error	A-3
2	Gain_error	A-4
3	Rin	A-5
4	Vref	A-6
5	Vih	A-7
6	Vil	A-8
7	Iih	A-9
8	Iil	A-10
9	Voh_D0	A-11
10	Voh_D1	A-12
11	Voh_D2	A-13
12	Voh_D3	A-14
13	Voh_D4	A-15
14	Voh_D5	A-16
15	Voh_D6	A-17
16	Voh_D7	A-18
17	Voh_D8	A-19
18	Voh_D9	A-20
19	Voh_D10	A-21
20	Voh_D11	A-22
21	Vol_D0	A-23
22	Vol_D1	A-24
23	Vol_D2	A-25
24	Vol_D3	A-26
25	Vol_D4	A-27
26	Vol_D5	A-28
27	Vol_D6	A-29
28	Vol_D7	A-30
29	Vol_D8	A-31
30	Vol_D9	A-32
31	Vol_D10	A-33
32	Vol_D11	A-34
33	ICCD	A-35
34	ICCA	A-36
35	ICC_TOTAL	A-37

Contents :

36 tod	A-38
37 SNR	A-39
38 SINAD	A-40
39 WS	A-41
40 DNL_MIN	A-42
41 DNL_MAX	A-43
42 INL_MIN	A-44
43 INL_MAX	A-45

1. Offset_error

Ta = 25°C; AVcc = DVcc = +5V; Vref tied to Voffset through 50 ohms

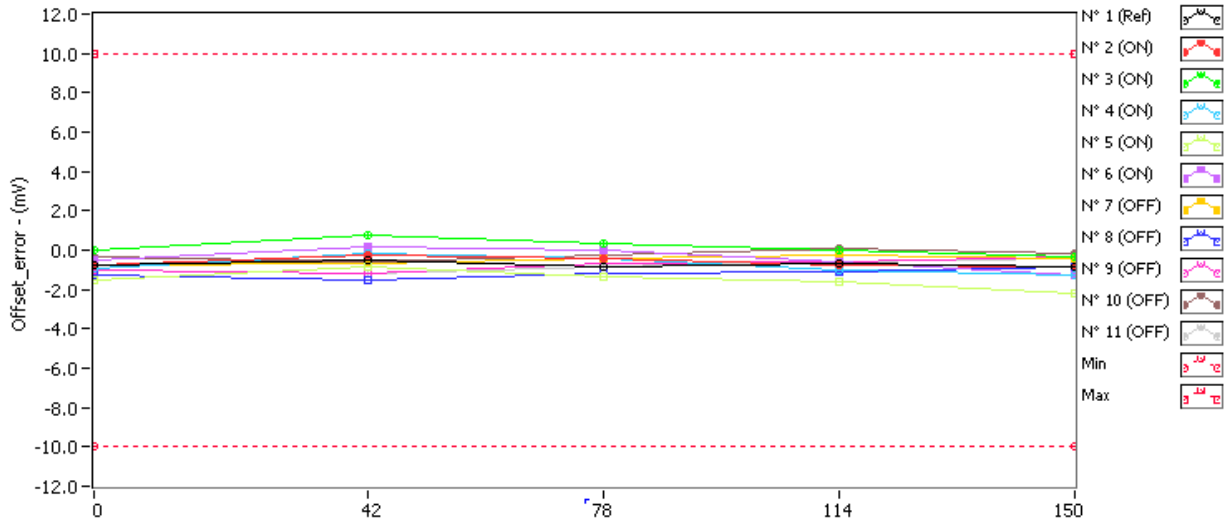

Offset_error . (mV) Min = -10.0 Max = 10.0

	0krad(Si)	42krad(Si)	78krad(Si)	114krad(Si)	150krad(Si)
N° 1 (Ref)	-0.776	-0.486	-0.878	-0.665	-0.822
N° 2 (ON)	-0.789	-0.242	-0.462	-0.735	-0.808
N° 3 (ON)	-0.002	0.720	0.358	-0.036	-0.328
N° 4 (ON)	-0.957	-0.161	-0.464	-1.054	-1.240
N° 5 (ON)	-1.542	-0.870	-1.317	-1.589	-2.183
N° 6 (ON)	-0.474	0.129	-0.031	-0.610	-1.241
N° 7 (OFF)	-0.722	-0.648	-0.398	-0.246	-0.398
N° 8 (OFF)	-1.271	-1.547	-1.163	-1.112	-0.832
N° 9 (OFF)	-0.981	-1.179	-0.668	-0.616	-0.353
N° 10 (OFF)	-0.347	-0.601	-0.258	0.121	-0.207
N° 11 (OFF)	-1.054	-1.172	-0.843	-0.572	-0.432

Delta [Offset_error]

	0krad(Si)	42krad(Si)	78krad(Si)	114krad(Si)	150krad(Si)
N° 1 (Ref)	---	2.904E-1	-1.020E-1	1.114E-1	-4.545E-2
N° 2 (ON)	---	5.471E-1	3.267E-1	5.357E-2	-1.896E-2
N° 3 (ON)	---	7.218E-1	3.598E-1	-3.367E-2	-3.254E-1
N° 4 (ON)	---	7.964E-1	4.934E-1	-9.684E-2	-2.832E-1
N° 5 (ON)	---	6.717E-1	2.252E-1	-4.682E-2	-6.416E-1
N° 6 (ON)	---	6.029E-1	4.424E-1	-1.364E-1	-7.671E-1
N° 7 (OFF)	---	7.390E-2	3.237E-1	4.755E-1	3.234E-1
N° 8 (OFF)	---	-2.751E-1	1.085E-1	1.591E-1	4.394E-1
N° 9 (OFF)	---	-1.986E-1	3.124E-1	3.651E-1	6.273E-1
N° 10 (OFF)	---	-2.545E-1	8.909E-2	4.684E-1	1.395E-1
N° 11 (OFF)	---	-1.177E-1	2.115E-1	4.820E-1	6.226E-1
Average (ON)	---	6.680E-1	3.695E-1	-5.203E-2	-4.072E-1
s (ON)	---	9.780E-2	1.042E-1	7.183E-2	2.988E-1
Average+3s (ON)	---	9.614E-1	6.820E-1	1.635E-1	4.893E-1
Average-3s (ON)	---	3.746E-1	5.689E-2	-2.675E-1	-1.304E+0
Average (OFF)	---	-1.544E-1	2.091E-1	3.900E-1	4.305E-1
s (OFF)	---	1.414E-1	1.099E-1	1.377E-1	2.073E-1
Average+3s (OFF)	---	2.699E-1	5.389E-1	8.032E-1	1.052E+0
Average-3s (OFF)	---	-5.787E-1	-1.207E-1	-2.316E-2	-1.914E-1

2. Gain_error

Ta = 25°C; AVcc = DVcc = +5V; Vref tied to Voffset through 50 ohms

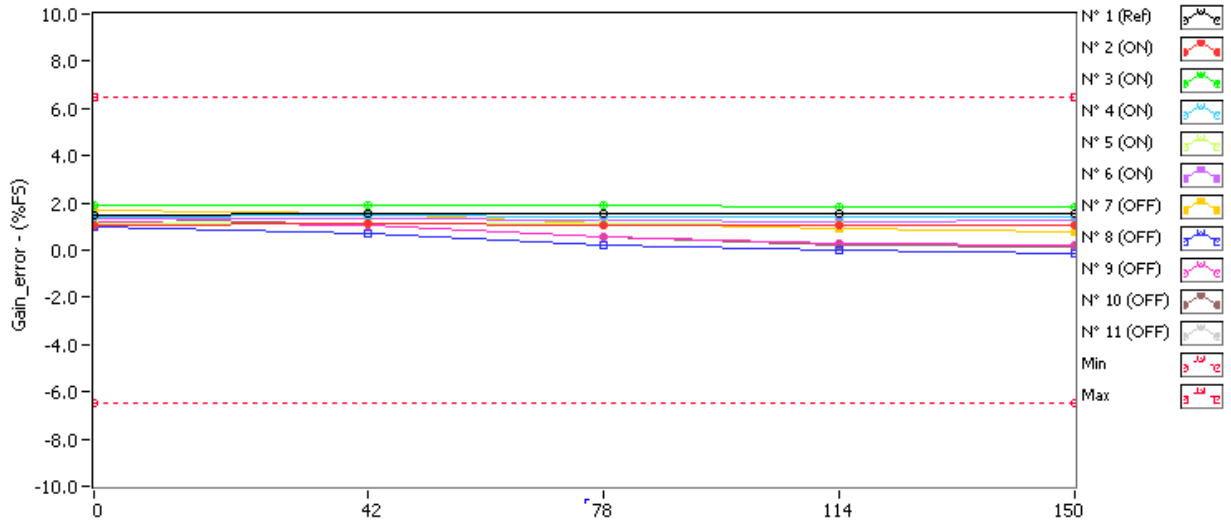

Gain_error . (%FS) Min = -6.5 Max = 6.5

	0krad(Si)	42krad(Si)	78krad(Si)	114krad(Si)	150krad(Si)
N° 1 (Ref)	1.469	1.529	1.567	1.532	1.557
N° 2 (ON)	1.066	1.095	1.050	1.063	1.051
N° 3 (ON)	1.874	1.893	1.883	1.858	1.849
N° 4 (ON)	1.416	1.453	1.376	1.417	1.382
N° 5 (ON)	1.097	1.124	1.115	1.073	1.044
N° 6 (ON)	1.340	1.361	1.267	1.210	1.289
N° 7 (OFF)	1.724	1.524	1.119	0.885	0.800
N° 8 (OFF)	0.987	0.728	0.226	-0.016	-0.115
N° 9 (OFF)	1.202	1.027	0.538	0.296	0.216
N° 10 (OFF)	1.435	1.023	0.537	0.228	0.136
N° 11 (OFF)	1.428	1.037	0.587	0.256	0.202

Delta [Gain_error]

	0krad(Si)	42krad(Si)	78krad(Si)	114krad(Si)	150krad(Si)
N° 1 (Ref)	---	5.964E-2	9.789E-2	6.313E-2	8.847E-2
N° 2 (ON)	---	2.872E-2	-1.593E-2	-2.790E-3	-1.535E-2
N° 3 (ON)	---	1.837E-2	8.487E-3	-1.651E-2	-2.558E-2
N° 4 (ON)	---	3.743E-2	-3.988E-2	1.046E-3	-3.371E-2
N° 5 (ON)	---	2.662E-2	1.814E-2	-2.383E-2	-5.301E-2
N° 6 (ON)	---	2.139E-2	-7.278E-2	-1.297E-1	-5.092E-2
N° 7 (OFF)	---	-1.996E-1	-6.047E-1	-8.384E-1	-9.232E-1
N° 8 (OFF)	---	-2.590E-1	-7.607E-1	-1.003E+0	-1.102E+0
N° 9 (OFF)	---	-1.743E-1	-6.636E-1	-9.061E-1	-9.857E-1
N° 10 (OFF)	---	-4.121E-1	-8.981E-1	-1.207E+0	-1.298E+0
N° 11 (OFF)	---	-3.909E-1	-8.415E-1	-1.172E+0	-1.226E+0
Average (ON)	---	2.651E-2	-2.039E-2	-3.437E-2	-3.571E-2
s (ON)	---	7.361E-3	3.695E-2	5.426E-2	1.622E-2
Average+3s (ON)	---	4.859E-2	9.047E-2	1.284E-1	1.294E-2
Average-3s (ON)	---	4.425E-3	-1.313E-1	-1.972E-1	-8.437E-2
Average (OFF)	---	-2.872E-1	-7.537E-1	-1.025E+0	-1.107E+0
s (OFF)	---	1.091E-1	1.214E-1	1.613E-1	1.576E-1
Average+3s (OFF)	---	3.998E-2	-3.896E-1	-5.414E-1	-6.344E-1
Average-3s (OFF)	---	-6.143E-1	-1.118E+0	-1.509E+0	-1.580E+0

3. Rin

Ta = 25°C; AVcc = DVcc = +5V; Vref tied to Voffset through 50 ohms

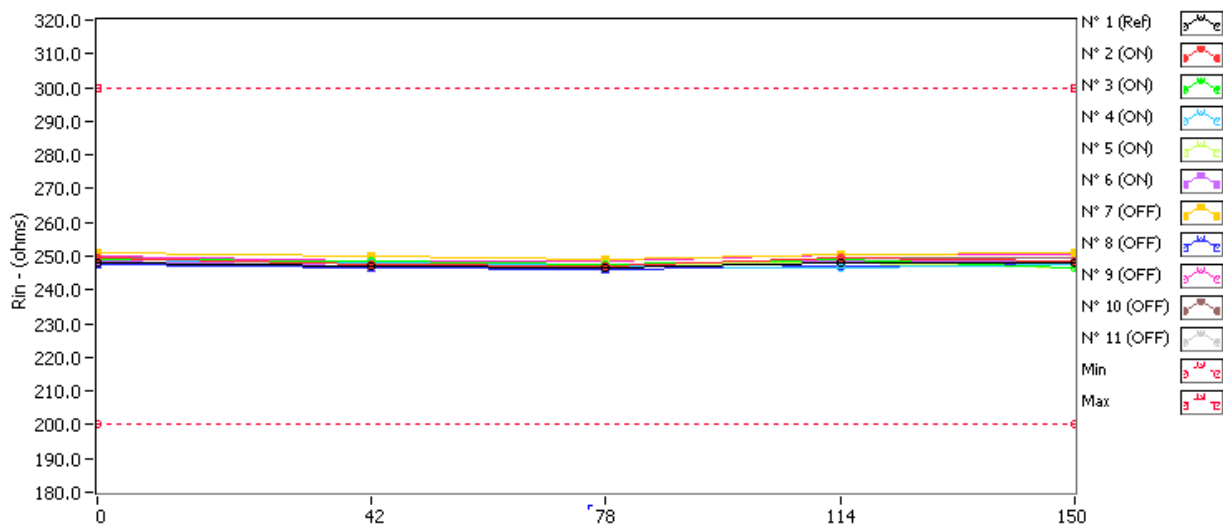

Rin . (ohms) Min = 200.0 Max = 300.0

	0krad(Si)	42krad(Si)	78krad(Si)	114krad(Si)	150krad(Si)
N° 1 (Ref)	248.21	247.26	246.62	248.15	247.79
N° 2 (ON)	249.49	247.40	246.96	249.29	248.60
N° 3 (ON)	249.11	248.32	247.53	249.08	246.75
N° 4 (ON)	249.13	248.27	247.19	246.48	247.41
N° 5 (ON)	248.93	247.90	247.60	248.24	246.39
N° 6 (ON)	248.64	247.06	246.81	248.68	248.49
N° 7 (OFF)	250.90	250.20	248.82	250.50	250.82
N° 8 (OFF)	247.56	246.60	246.15	247.12	247.61
N° 9 (OFF)	250.00	248.66	248.54	250.42	250.37
N° 10 (OFF)	249.44	248.66	246.98	249.39	249.44
N° 11 (OFF)	248.23	248.04	247.02	248.94	248.19

Delta [Rin]

	0krad(Si)	42krad(Si)	78krad(Si)	114krad(Si)	150krad(Si)
N° 1 (Ref)	---	-9.506E-1	-1.588E+0	-5.290E-2	-4.176E-1
N° 2 (ON)	---	-2.095E+0	-2.532E+0	-2.077E-1	-8.962E-1
N° 3 (ON)	---	-7.931E-1	-1.583E+0	-3.350E-2	-2.365E+0
N° 4 (ON)	---	-8.567E-1	-1.944E+0	-2.647E+0	-1.721E+0
N° 5 (ON)	---	-1.033E+0	-1.326E+0	-6.933E-1	-2.542E+0
N° 6 (ON)	---	-1.579E+0	-1.826E+0	4.330E-2	-1.538E-1
N° 7 (OFF)	---	-6.987E-1	-2.077E+0	-3.979E-1	-8.430E-2
N° 8 (OFF)	---	-9.560E-1	-1.410E+0	-4.374E-1	5.390E-2
N° 9 (OFF)	---	-1.334E+0	-1.454E+0	4.232E-1	3.706E-1
N° 10 (OFF)	---	-7.778E-1	-2.460E+0	-5.220E-2	6.900E-3
N° 11 (OFF)	---	-1.860E-1	-1.208E+0	7.119E-1	-3.450E-2
Average (ON)	---	-1.271E+0	-1.842E+0	-7.076E-1	-1.536E+0
s (ON)	---	5.546E-1	4.527E-1	1.121E+0	1.007E+0
Average+3s (ON)	---	3.924E-1	-4.842E-1	2.656E+0	1.484E+0
Average-3s (ON)	---	-2.935E+0	-3.201E+0	-4.071E+0	-4.556E+0
Average (OFF)	---	-7.905E-1	-1.722E+0	4.952E-2	6.252E-2
s (OFF)	---	4.174E-1	5.254E-1	5.065E-1	1.796E-1
Average+3s (OFF)	---	4.616E-1	-1.457E-1	1.569E+0	6.014E-1
Average-3s (OFF)	---	-2.043E+0	-3.298E+0	-1.470E+0	-4.763E-1

4. Vref

Ta = 25°C; AVcc = DVcc = +5V; Vref tied to Voffset through 50 ohms

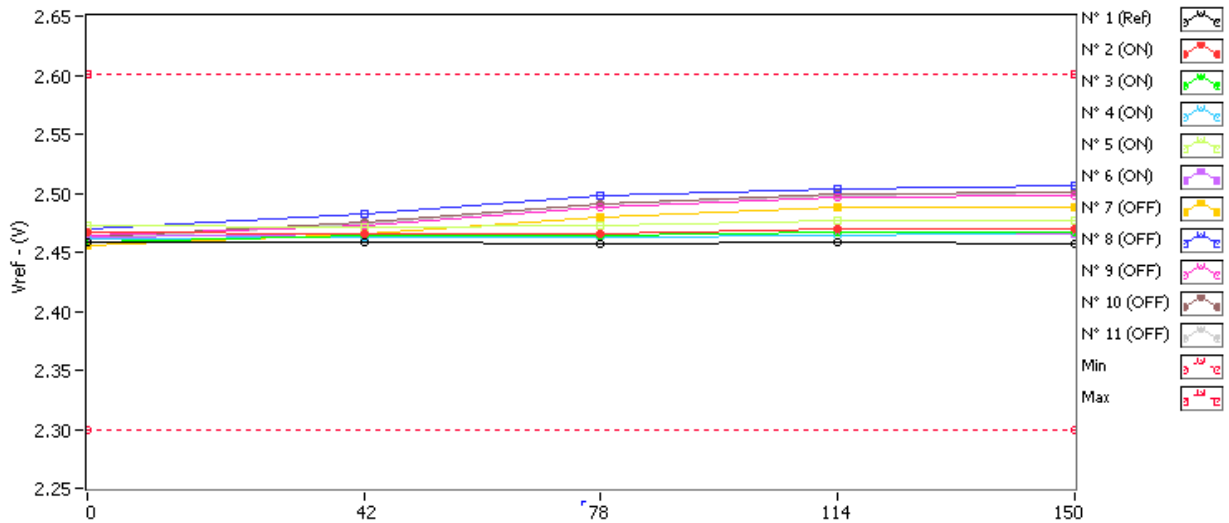

Vref . (V) Min = 2.3 Max = 2.6

	0krad(Si)	42krad(Si)	78krad(Si)	114krad(Si)	150krad(Si)
N° 1 (Ref)	2.459	2.458	2.457	2.458	2.457
N° 2 (ON)	2.467	2.466	2.466	2.470	2.470
N° 3 (ON)	2.458	2.464	2.464	2.466	2.466
N° 4 (ON)	2.461	2.463	2.462	2.464	2.467
N° 5 (ON)	2.472	2.471	2.472	2.476	2.476
N° 6 (ON)	2.462	2.466	2.464	2.467	2.466
N° 7 (OFF)	2.456	2.465	2.480	2.488	2.488
N° 8 (OFF)	2.470	2.483	2.498	2.503	2.507
N° 9 (OFF)	2.464	2.473	2.489	2.497	2.498
N° 10 (OFF)	2.462	2.475	2.490	2.499	2.501
N° 11 (OFF)	2.461	2.475	2.492	2.499	2.500

Delta [Vref]

	0krad(Si)	42krad(Si)	78krad(Si)	114krad(Si)	150krad(Si)
N° 1 (Ref)	---	-7.800E-4	-1.110E-3	-3.600E-4	-2.050E-3
N° 2 (ON)	---	-1.080E-3	-8.500E-4	3.530E-3	3.600E-3
N° 3 (ON)	---	5.690E-3	5.870E-3	7.900E-3	7.820E-3
N° 4 (ON)	---	1.540E-3	6.100E-4	2.890E-3	5.360E-3
N° 5 (ON)	---	-7.900E-4	3.300E-4	4.150E-3	4.470E-3
N° 6 (ON)	---	3.320E-3	1.330E-3	5.130E-3	3.590E-3
N° 7 (OFF)	---	8.680E-3	2.411E-2	3.184E-2	3.234E-2
N° 8 (OFF)	---	1.275E-2	2.749E-2	3.286E-2	3.645E-2
N° 9 (OFF)	---	9.210E-3	2.490E-2	3.308E-2	3.413E-2
N° 10 (OFF)	---	1.312E-2	2.782E-2	3.632E-2	3.823E-2
N° 11 (OFF)	---	1.361E-2	3.054E-2	3.759E-2	3.936E-2
Average (ON)	---	1.736E-3	1.458E-3	4.720E-3	4.968E-3
s (ON)	---	2.850E-3	2.588E-3	1.960E-3	1.754E-3
Average+3s (ON)	---	1.029E-2	9.223E-3	1.060E-2	1.023E-2
Average-3s (ON)	---	-6.814E-3	-6.307E-3	-1.161E-3	-2.940E-4
Average (OFF)	---	1.147E-2	2.697E-2	3.434E-2	3.610E-2
s (OFF)	---	2.336E-3	2.559E-3	2.475E-3	2.886E-3
Average+3s (OFF)	---	1.848E-2	3.465E-2	4.176E-2	4.476E-2
Average-3s (OFF)	---	4.465E-3	1.929E-2	2.691E-2	2.745E-2

5. Vih

Ta = 25°C; AVcc = DVcc = +5V; Vref tied to Voffset through 50 ohms

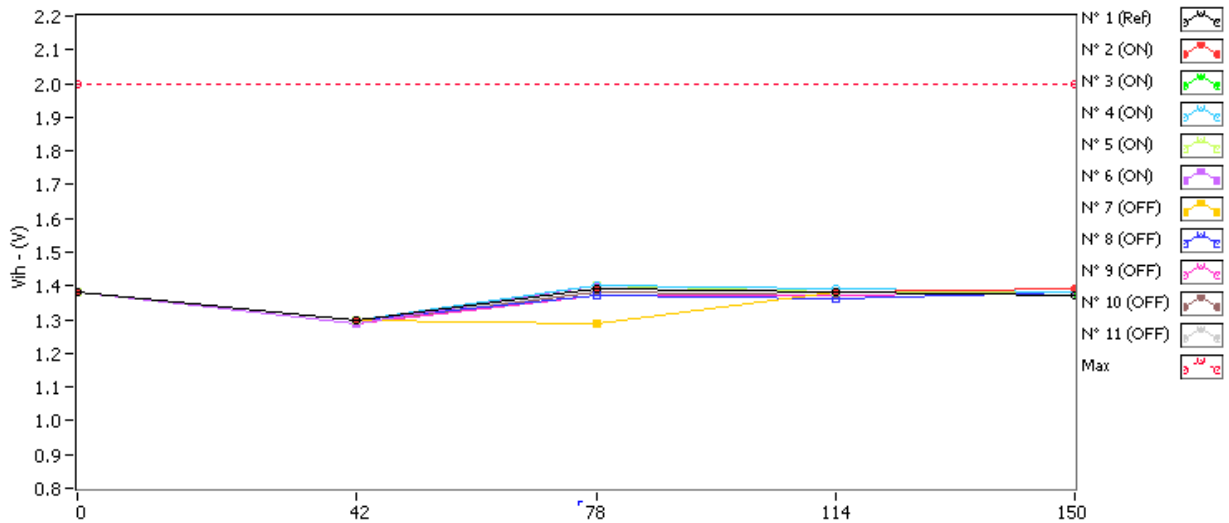

Vih . (V) Max = 2.0

	0krad(Si)	42krad(Si)	78krad(Si)	114krad(Si)	150krad(Si)
N° 1 (Ref)	1.38	1.30	1.39	1.38	1.37
N° 2 (ON)	1.38	1.30	1.39	1.38	1.39
N° 3 (ON)	1.38	1.30	1.39	1.38	1.37
N° 4 (ON)	1.38	1.30	1.40	1.39	1.38
N° 5 (ON)	1.38	1.30	1.40	1.38	1.38
N° 6 (ON)	1.38	1.29	1.40	1.38	1.38
N° 7 (OFF)	1.38	1.30	1.29	1.38	1.38
N° 8 (OFF)	1.38	1.30	1.37	1.36	1.38
N° 9 (OFF)	1.38	1.29	1.37	1.37	1.38
N° 10 (OFF)	1.38	1.29	1.38	1.37	1.38
N° 11 (OFF)	1.38	1.30	1.38	1.37	1.38

Delta [Vih]

	0krad(Si)	42krad(Si)	78krad(Si)	114krad(Si)	150krad(Si)
N° 1 (Ref)	---	-8.000E-2	1.000E-2	0.000E+0	-1.000E-2
N° 2 (ON)	---	-8.000E-2	1.000E-2	0.000E+0	1.000E-2
N° 3 (ON)	---	-8.000E-2	1.000E-2	0.000E+0	-1.000E-2
N° 4 (ON)	---	-8.000E-2	2.000E-2	1.000E-2	0.000E+0
N° 5 (ON)	---	-8.000E-2	2.000E-2	0.000E+0	0.000E+0
N° 6 (ON)	---	-9.000E-2	2.000E-2	0.000E+0	0.000E+0
N° 7 (OFF)	---	-8.000E-2	-9.000E-2	0.000E+0	0.000E+0
N° 8 (OFF)	---	-8.000E-2	-1.000E-2	-2.000E-2	0.000E+0
N° 9 (OFF)	---	-9.000E-2	-1.000E-2	-1.000E-2	0.000E+0
N° 10 (OFF)	---	-9.000E-2	0.000E+0	-1.000E-2	0.000E+0
N° 11 (OFF)	---	-8.000E-2	0.000E+0	-1.000E-2	0.000E+0
Average (ON)	---	-8.200E-2	1.600E-2	2.000E-2	4.441E-17
s (ON)	---	4.472E-3	5.477E-3	4.472E-3	7.071E-3
Average+3s (ON)	---	-6.858E-2	3.243E-2	1.542E-2	2.121E-2
Average-3s (ON)	---	-9.542E-2	-4.317E-4	-1.142E-2	-2.121E-2
Average (OFF)	---	-8.400E-2	-2.200E-2	-1.000E-2	0.000E+0
s (OFF)	---	5.477E-3	3.834E-2	7.071E-3	0.000E+0
Average+3s (OFF)	---	-6.757E-2	9.302E-2	1.121E-2	0.000E+0
Average-3s (OFF)	---	-1.004E-1	-1.370E-1	-3.121E-2	0.000E+0

6. Vil

Ta = 25°C; AVcc = DVcc = +5V; Vref tied to Voffset through 50 ohms

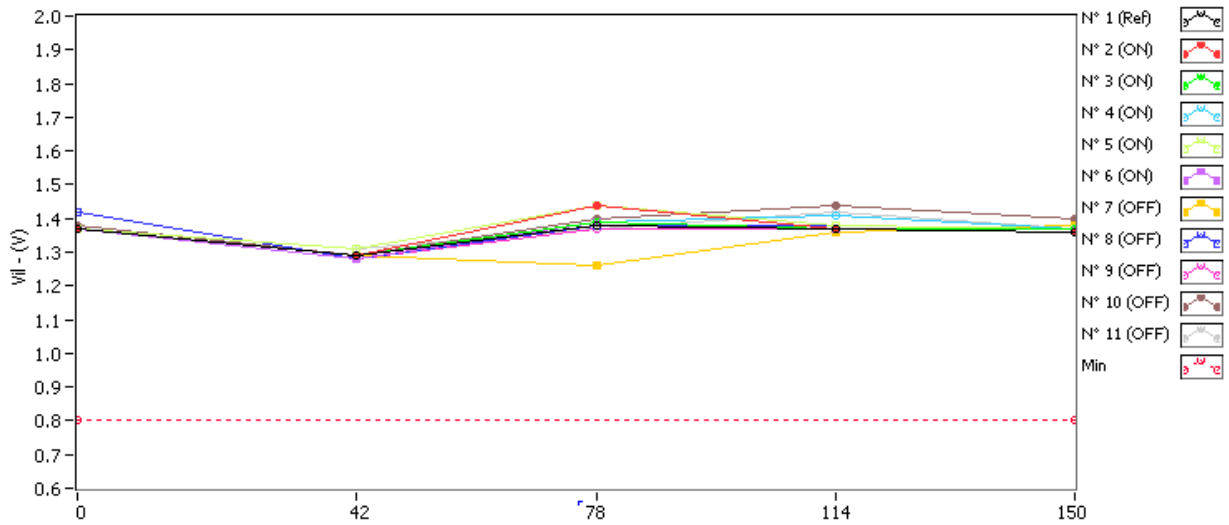

Vil . (V) Min = 0.8

	0krad(Si)	42krad(Si)	78krad(Si)	114krad(Si)	150krad(Si)
N° 1 (Ref)	1.37	1.29	1.38	1.37	1.36
N° 2 (ON)	1.37	1.29	1.44	1.37	1.36
N° 3 (ON)	1.37	1.29	1.39	1.37	1.37
N° 4 (ON)	1.37	1.29	1.39	1.41	1.37
N° 5 (ON)	1.37	1.31	1.44	1.38	1.37
N° 6 (ON)	1.37	1.28	1.39	1.37	1.37
N° 7 (OFF)	1.37	1.29	1.26	1.36	1.38
N° 8 (OFF)	1.42	1.28	1.38	1.38	1.37
N° 9 (OFF)	1.37	1.28	1.37	1.37	1.37
N° 10 (OFF)	1.38	1.29	1.40	1.44	1.40
N° 11 (OFF)	1.37	1.31	1.37	1.42	1.37

Delta [Vil]

	0krad(Si)	42krad(Si)	78krad(Si)	114krad(Si)	150krad(Si)
N° 1 (Ref)	---	-8.000E-2	1.000E-2	0.000E+0	-1.000E-2
N° 2 (ON)	---	-8.000E-2	7.000E-2	0.000E+0	-1.000E-2
N° 3 (ON)	---	-8.000E-2	2.000E-2	0.000E+0	0.000E+0
N° 4 (ON)	---	-8.000E-2	2.000E-2	4.000E-2	0.000E+0
N° 5 (ON)	---	-6.000E-2	7.000E-2	1.000E-2	0.000E+0
N° 6 (ON)	---	-9.000E-2	2.000E-2	0.000E+0	0.000E+0
N° 7 (OFF)	---	-8.000E-2	-1.100E-1	-1.000E-2	1.000E-2
N° 8 (OFF)	---	-1.400E-1	-4.000E-2	-4.000E-2	-5.000E-2
N° 9 (OFF)	---	-9.000E-2	0.000E+0	0.000E+0	0.000E+0
N° 10 (OFF)	---	-9.000E-2	2.000E-2	6.000E-2	2.000E-2
N° 11 (OFF)	---	-6.000E-2	0.000E+0	5.000E-2	0.000E+0
Average (ON)	---	-7.800E-2	4.000E-2	1.000E-2	-2.000E-3
s (ON)	---	1.095E-2	2.739E-2	1.732E-2	4.472E-3
Average+3s (ON)	---	-4.514E-2	1.222E-1	6.196E-2	1.142E-2
Average-3s (ON)	---	-1.109E-1	-4.216E-2	-4.196E-2	-1.542E-2
Average (OFF)	---	-9.200E-2	-2.600E-2	1.200E-2	-4.000E-3
s (OFF)	---	2.950E-2	5.177E-2	4.207E-2	2.702E-2
Average+3s (OFF)	---	-3.513E-3	1.293E-1	1.382E-1	7.706E-2
Average-3s (OFF)	---	-1.805E-1	-1.813E-1	-1.142E-1	-8.506E-2

7. Iih

Ta = 25°C; AVcc = DVcc = +5V; Vref tied to Voffset through 50 ohms, Vinl = 5V

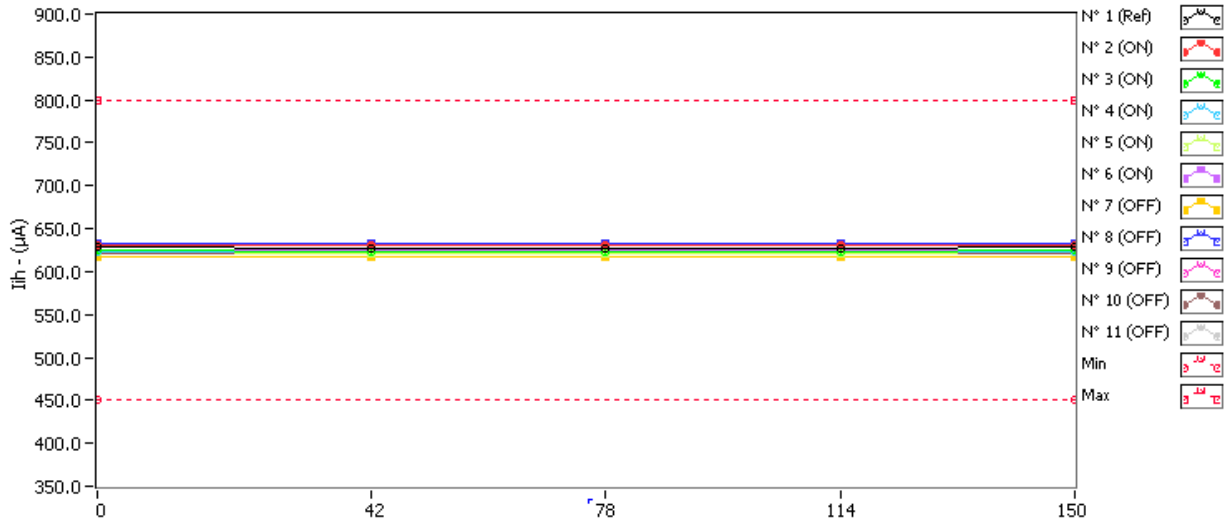

Iih . (µA) Min = 450.0 Max = 800.0

	0krad(Si)	42krad(Si)	78krad(Si)	114krad(Si)	150krad(Si)
N° 1 (Ref)	628.03	627.79	627.73	627.79	627.97
N° 2 (ON)	630.35	630.07	630.15	630.08	630.24
N° 3 (ON)	624.20	623.96	623.98	623.97	624.16
N° 4 (ON)	623.24	622.87	622.86	622.82	623.03
N° 5 (ON)	622.29	622.00	621.98	621.97	622.18
N° 6 (ON)	625.30	625.04	625.02	625.00	625.21
N° 7 (OFF)	618.08	617.71	617.70	617.75	617.90
N° 8 (OFF)	633.44	633.12	633.16	633.18	633.28
N° 9 (OFF)	625.71	625.37	625.39	625.48	625.55
N° 10 (OFF)	622.10	621.80	621.82	621.99	622.00
N° 11 (OFF)	622.14	621.86	621.85	621.92	622.03

Delta [Iih]

	0krad(Si)	42krad(Si)	78krad(Si)	114krad(Si)	150krad(Si)
N° 1 (Ref)	---	-2.340E-1	-3.030E-1	-2.390E-1	-5.500E-2
N° 2 (ON)	---	-2.820E-1	-2.040E-1	-2.760E-1	-1.130E-1
N° 3 (ON)	---	-2.380E-1	-2.160E-1	-2.290E-1	-4.000E-2
N° 4 (ON)	---	-3.630E-1	-3.800E-1	-4.210E-1	-2.040E-1
N° 5 (ON)	---	-2.950E-1	-3.140E-1	-3.200E-1	-1.080E-1
N° 6 (ON)	---	-2.600E-1	-2.780E-1	-3.000E-1	-9.600E-2
N° 7 (OFF)	---	-3.610E-1	-3.740E-1	-3.270E-1	-1.730E-1
N° 8 (OFF)	---	-3.230E-1	-2.820E-1	-2.540E-1	-1.620E-1
N° 9 (OFF)	---	-3.340E-1	-3.150E-1	-2.270E-1	-1.540E-1
N° 10 (OFF)	---	-2.920E-1	-2.780E-1	-1.050E-1	-9.500E-2
N° 11 (OFF)	---	-2.790E-1	-2.860E-1	-2.190E-1	-1.050E-1
Average (ON)	---	-2.876E-1	-2.784E-1	-3.092E-1	-1.122E-1
s (ON)	---	4.742E-2	7.249E-2	7.112E-2	5.899E-2
Average+3s (ON)	---	-1.454E-1	-6.093E-2	-9.583E-2	6.478E-2
Average-3s (ON)	---	-4.298E-1	-4.959E-1	-5.226E-1	-2.892E-1
Average (OFF)	---	-3.178E-1	-3.070E-1	-2.264E-1	-1.378E-1
s (OFF)	---	3.289E-2	4.019E-2	8.012E-2	3.534E-2
Average+3s (OFF)	---	-2.191E-1	-1.864E-1	1.395E-2	-3.179E-2
Average-3s (OFF)	---	-4.165E-1	-4.276E-1	-4.668E-1	-2.438E-1

8. I_{II}

T_a = 25°C; AV_{cc} = DV_{cc} = +5V; V_{ref} tied to V_{offset} through 50 ohms, V_{in1} = 0V

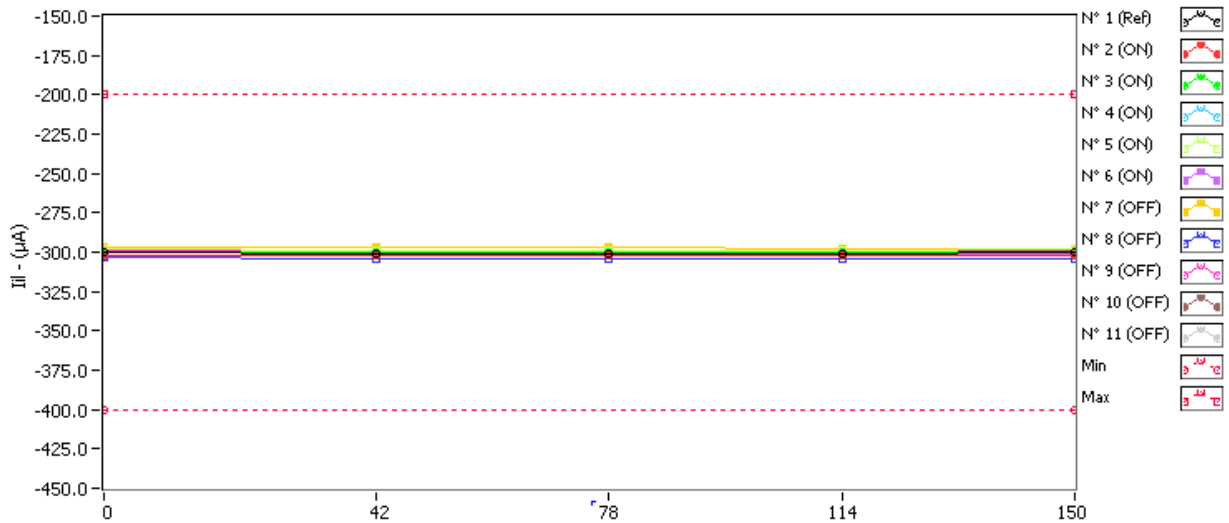

I_{II} (µA) Min = -400.0 Max = -200.0

	0krad(Si)	42krad(Si)	78krad(Si)	114krad(Si)	150krad(Si)
N° 1 (Ref)	-300.32	-300.56	-300.55	-300.56	-300.41
N° 2 (ON)	-301.99	-302.52	-302.39	-302.55	-302.31
N° 3 (ON)	-299.83	-300.24	-300.26	-300.30	-300.10
N° 4 (ON)	-299.50	-300.02	-300.05	-300.15	-299.89
N° 5 (ON)	-298.00	-298.44	-298.50	-298.51	-298.29
N° 6 (ON)	-300.34	-300.72	-300.72	-300.76	-300.57
N° 7 (OFF)	-296.30	-297.04	-297.36	-297.59	-297.72
N° 8 (OFF)	-303.59	-304.12	-304.30	-304.41	-304.49
N° 9 (OFF)	-299.18	-299.84	-300.09	-300.27	-300.42
N° 10 (OFF)	-298.61	-299.15	-299.27	-299.27	-299.45
N° 11 (OFF)	-298.95	-299.45	-299.61	-299.71	-299.70

Delta [I_{II}]

	0krad(Si)	42krad(Si)	78krad(Si)	114krad(Si)	150krad(Si)
N° 1 (Ref)	---	-2.390E-1	-2.260E-1	-2.370E-1	-8.600E-2
N° 2 (ON)	---	-5.250E-1	-3.920E-1	-5.590E-1	-3.150E-1
N° 3 (ON)	---	-4.100E-1	-4.290E-1	-4.650E-1	-2.690E-1
N° 4 (ON)	---	-5.220E-1	-5.470E-1	-6.430E-1	-3.830E-1
N° 5 (ON)	---	-4.400E-1	-5.010E-1	-5.080E-1	-2.890E-1
N° 6 (ON)	---	-3.810E-1	-3.840E-1	-4.210E-1	-2.360E-1
N° 7 (OFF)	---	-7.370E-1	-1.054E+0	-1.282E+0	-1.413E+0
N° 8 (OFF)	---	-5.310E-1	-7.040E-1	-8.130E-1	-8.930E-1
N° 9 (OFF)	---	-6.610E-1	-9.110E-1	-1.095E+0	-1.237E+0
N° 10 (OFF)	---	-5.410E-1	-6.600E-1	-6.600E-1	-8.400E-1
N° 11 (OFF)	---	-5.020E-1	-6.620E-1	-7.550E-1	-7.450E-1
Average (ON)	---	-4.556E-1	-4.506E-1	-5.192E-1	-2.984E-1
s (ON)	---	6.541E-2	7.101E-2	8.605E-2	5.541E-2
Average+3s (ON)	---	-2.594E-1	-2.376E-1	-2.611E-1	-1.322E-1
Average-3s (ON)	---	-6.518E-1	-6.636E-1	-7.773E-1	-4.646E-1
Average (OFF)	---	-5.944E-1	-7.982E-1	-9.210E-1	-1.026E+0
s (OFF)	---	1.002E-1	1.766E-1	2.588E-1	2.853E-1
Average+3s (OFF)	---	-2.937E-1	-2.685E-1	-1.446E-1	-1.698E-1
Average-3s (OFF)	---	-8.951E-1	-1.328E+0	-1.697E+0	-1.881E+0

9. Voh_D0

Ta = 25°C; AVcc = DVcc = +5V; Vref tied to Voffset through 50 ohms; loh= 10µA

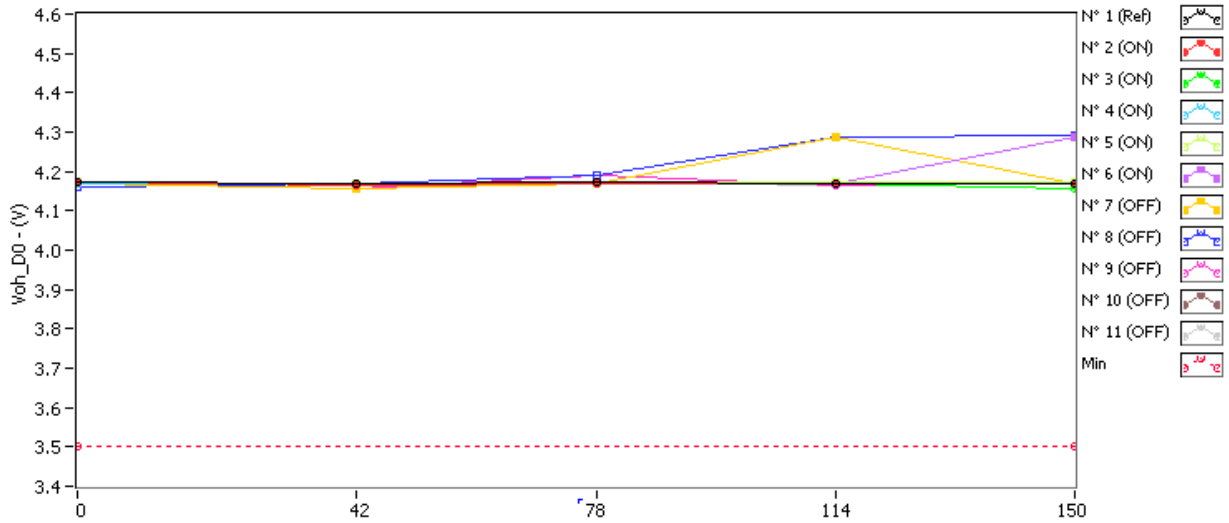

Voh_D0 . (V) Min = 3.5

	0krad(Si)	42krad(Si)	78krad(Si)	114krad(Si)	150krad(Si)
N° 1 (Ref)	4.172	4.169	4.173	4.169	4.168
N° 2 (ON)	4.172	4.167	4.167	4.169	4.170
N° 3 (ON)	4.173	4.170	4.172	4.171	4.157
N° 4 (ON)	4.170	4.170	4.173	4.169	4.170
N° 5 (ON)	4.173	4.171	4.170	4.172	4.172
N° 6 (ON)	4.170	4.168	4.170	4.169	4.287
N° 7 (OFF)	4.170	4.158	4.171	4.287	4.168
N° 8 (OFF)	4.160	4.169	4.191	4.288	4.290
N° 9 (OFF)	4.171	4.155	4.190	4.166	4.168
N° 10 (OFF)	4.173	4.171	4.171	4.168	4.168
N° 11 (OFF)	4.173	4.169	4.172	4.165	4.169

Delta [Voh_D0]

	0krad(Si)	42krad(Si)	78krad(Si)	114krad(Si)	150krad(Si)
N° 1 (Ref)	---	-3.160E-3	3.700E-4	-3.600E-3	-3.750E-3
N° 2 (ON)	---	-4.940E-3	-4.530E-3	-2.640E-3	-1.810E-3
N° 3 (ON)	---	-2.950E-3	-1.020E-3	-2.330E-3	-1.593E-2
N° 4 (ON)	---	-2.700E-4	2.940E-3	-7.900E-4	1.100E-4
N° 5 (ON)	---	-2.380E-3	-3.060E-3	-1.320E-3	-1.380E-3
N° 6 (ON)	---	-2.450E-3	-6.300E-4	-1.380E-3	1.169E-1
N° 7 (OFF)	---	-1.163E-2	9.000E-4	1.172E-1	-1.630E-3
N° 8 (OFF)	---	9.150E-3	3.076E-2	1.274E-1	1.295E-1
N° 9 (OFF)	---	-1.550E-2	1.900E-2	-4.470E-3	-2.470E-3
N° 10 (OFF)	---	-1.900E-3	-1.260E-3	-4.830E-3	-4.570E-3
N° 11 (OFF)	---	-3.410E-3	-6.600E-4	-7.940E-3	-4.030E-3
Average (ON)	---	-2.598E-3	-1.260E-3	-1.692E-3	1.957E-2
s (ON)	---	1.666E-3	2.830E-3	7.673E-4	5.478E-2
Average+3s (ON)	---	2.399E-3	7.229E-3	6.099E-4	1.839E-1
Average-3s (ON)	---	-7.595E-3	-9.749E-3	-3.994E-3	-1.448E-1
Average (OFF)	---	-4.658E-3	9.748E-3	4.547E-2	2.336E-2
s (OFF)	---	9.565E-3	1.445E-2	7.024E-2	5.934E-2
Average+3s (OFF)	---	2.404E-2	5.309E-2	2.562E-1	2.014E-1
Average-3s (OFF)	---	-3.335E-2	-3.359E-2	-1.652E-1	-1.547E-1

10. Voh_D1

Ta = 25°C; AVcc = DVcc = +5V; Vref tied to Voffset through 50 ohms; loh= 10µA

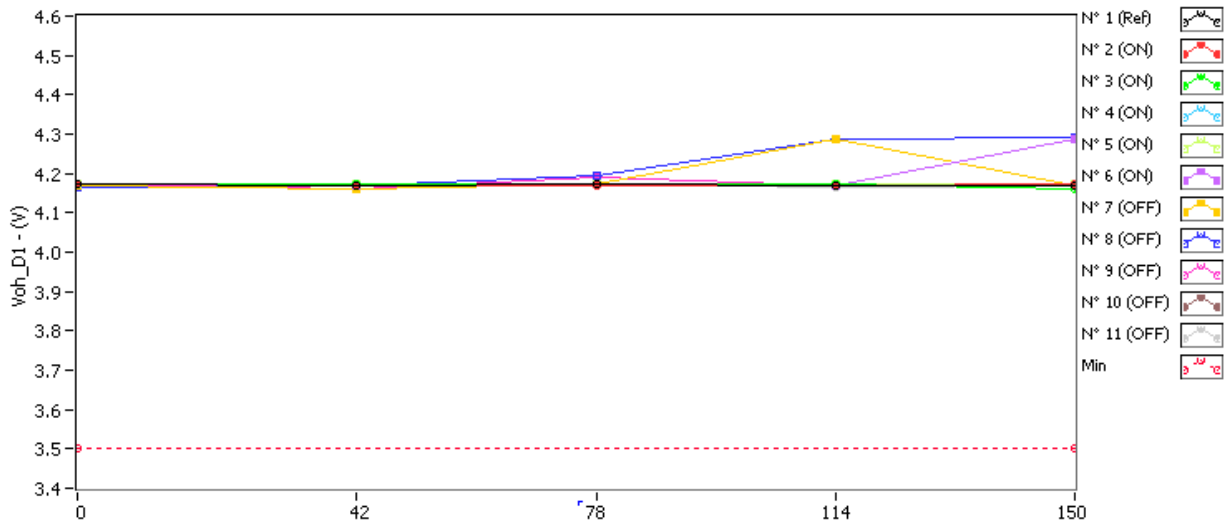

Voh_D1 . (V) Min = 3.5

	0krad(Si)	42krad(Si)	78krad(Si)	114krad(Si)	150krad(Si)
N° 1 (Ref)	4.174	4.171	4.174	4.170	4.170
N° 2 (ON)	4.173	4.168	4.169	4.171	4.171
N° 3 (ON)	4.175	4.172	4.174	4.172	4.162
N° 4 (ON)	4.172	4.171	4.175	4.171	4.172
N° 5 (ON)	4.174	4.172	4.171	4.173	4.173
N° 6 (ON)	4.172	4.170	4.172	4.170	4.289
N° 7 (OFF)	4.171	4.162	4.172	4.288	4.169
N° 8 (OFF)	4.164	4.171	4.192	4.289	4.291
N° 9 (OFF)	4.172	4.159	4.191	4.168	4.170
N° 10 (OFF)	4.174	4.172	4.173	4.169	4.170
N° 11 (OFF)	4.174	4.171	4.174	4.167	4.170

Delta [Voh_D1]

	0krad(Si)	42krad(Si)	78krad(Si)	114krad(Si)	150krad(Si)
N° 1 (Ref)	---	-3.090E-3	3.400E-4	-3.700E-3	-3.680E-3
N° 2 (ON)	---	-4.920E-3	-4.450E-3	-2.600E-3	-1.920E-3
N° 3 (ON)	---	-2.980E-3	-9.200E-4	-2.240E-3	-1.283E-2
N° 4 (ON)	---	-2.200E-4	2.930E-3	-6.800E-4	1.300E-4
N° 5 (ON)	---	-2.360E-3	-2.890E-3	-1.300E-3	-1.380E-3
N° 6 (ON)	---	-2.400E-3	-5.500E-4	-2.140E-3	1.170E-1
N° 7 (OFF)	---	-8.760E-3	8.800E-4	1.172E-1	-1.590E-3
N° 8 (OFF)	---	6.300E-3	2.796E-2	1.245E-1	1.266E-1
N° 9 (OFF)	---	-1.332E-2	1.910E-2	-4.440E-3	-2.530E-3
N° 10 (OFF)	---	-1.850E-3	-1.210E-3	-4.780E-3	-4.490E-3
N° 11 (OFF)	---	-3.430E-3	-6.800E-4	-7.790E-3	-4.000E-3
Average (ON)	---	-2.576E-3	-1.176E-3	-1.792E-3	2.020E-2
s (ON)	---	1.680E-3	2.783E-3	7.831E-4	5.435E-2
Average+3s (ON)	---	2.463E-3	7.172E-3	5.574E-4	1.833E-1
Average-3s (ON)	---	-7.615E-3	-9.524E-3	-4.141E-3	-1.429E-1
Average (OFF)	---	-4.212E-3	9.210E-3	4.495E-2	2.281E-2
s (OFF)	---	7.422E-3	1.346E-2	6.937E-2	5.806E-2
Average+3s (OFF)	---	1.805E-2	4.960E-2	2.531E-1	1.970E-1
Average-3s (OFF)	---	-2.648E-2	-3.118E-2	-1.632E-1	-1.514E-1

11. Voh_D2

Ta = 25°C; AVcc = DVcc = +5V; Vref tied to Voffset through 50 ohms; loh= 10µA

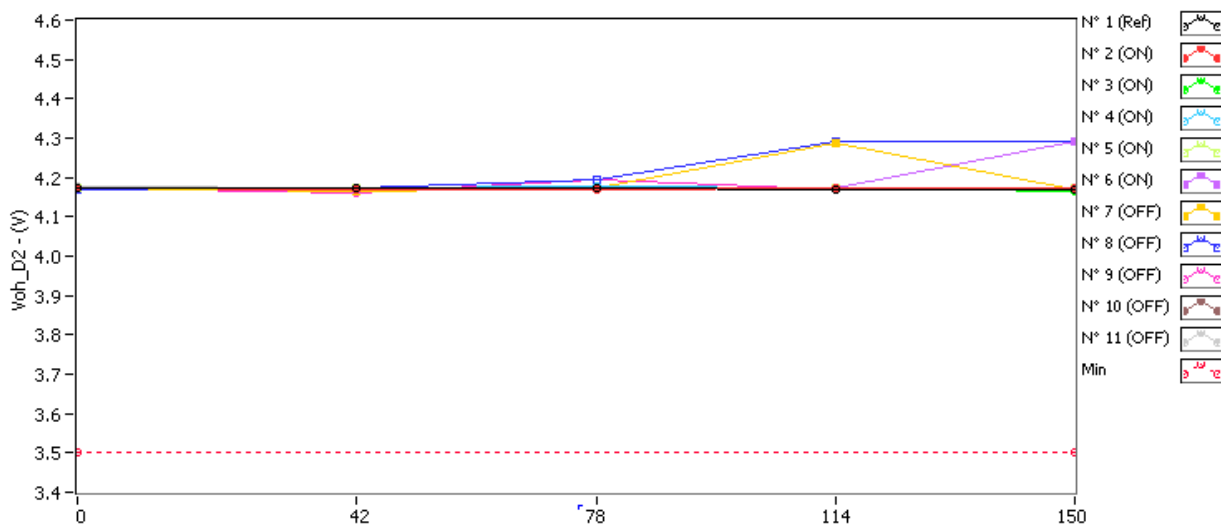

Voh_D2 . (V) **Min = 3.5**

	0krad(Si)	42krad(Si)	78krad(Si)	114krad(Si)	150krad(Si)
N° 1 (Ref)	4.175	4.172	4.175	4.171	4.171
N° 2 (ON)	4.174	4.169	4.169	4.171	4.172
N° 3 (ON)	4.175	4.172	4.174	4.173	4.165
N° 4 (ON)	4.173	4.172	4.176	4.172	4.173
N° 5 (ON)	4.175	4.173	4.172	4.174	4.174
N° 6 (ON)	4.173	4.171	4.172	4.171	4.290
N° 7 (OFF)	4.172	4.165	4.173	4.289	4.170
N° 8 (OFF)	4.167	4.172	4.194	4.290	4.292
N° 9 (OFF)	4.173	4.161	4.192	4.169	4.171
N° 10 (OFF)	4.175	4.173	4.174	4.170	4.171
N° 11 (OFF)	4.176	4.172	4.175	4.168	4.172

Delta [Voh_D2]

	0krad(Si)	42krad(Si)	78krad(Si)	114krad(Si)	150krad(Si)
N° 1 (Ref)	---	-3.130E-3	2.700E-4	-3.900E-3	-3.680E-3
N° 2 (ON)	---	-4.960E-3	-4.430E-3	-2.650E-3	-2.060E-3
N° 3 (ON)	---	-3.020E-3	-9.000E-4	-2.190E-3	-1.071E-2
N° 4 (ON)	---	-2.300E-4	2.910E-3	-6.900E-4	1.100E-4
N° 5 (ON)	---	-2.320E-3	-2.830E-3	-1.310E-3	-1.370E-3
N° 6 (ON)	---	-2.360E-3	-5.100E-4	-1.610E-3	1.170E-1
N° 7 (OFF)	---	-6.850E-3	8.900E-4	1.173E-1	-1.580E-3
N° 8 (OFF)	---	4.470E-3	2.616E-2	1.227E-1	1.248E-1
N° 9 (OFF)	---	-1.244E-2	1.914E-2	-4.410E-3	-2.580E-3
N° 10 (OFF)	---	-1.860E-3	-1.220E-3	-4.780E-3	-4.450E-3
N° 11 (OFF)	---	-3.430E-3	-6.900E-4	-7.660E-3	-3.950E-3
Average (ON)	---	-2.578E-3	-1.152E-3	-1.690E-3	2.060E-2
s (ON)	---	1.695E-3	2.763E-3	7.620E-4	5.407E-2
Average+3s (ON)	---	2.508E-3	7.137E-3	5.959E-4	1.828E-1
Average-3s (ON)	---	-7.664E-3	-9.441E-3	-3.976E-3	-1.416E-1
Average (OFF)	---	-4.022E-3	8.856E-3	4.462E-2	2.244E-2
s (OFF)	---	6.245E-3	1.286E-2	6.883E-2	5.721E-2
Average+3s (OFF)	---	1.471E-2	4.743E-2	2.511E-1	1.941E-1
Average-3s (OFF)	---	-2.276E-2	-2.972E-2	-1.619E-1	-1.492E-1

12. Voh_D3

Ta = 25°C; AVcc = DVcc = +5V; Vref tied to Voffset through 50 ohms; loh= 10µA

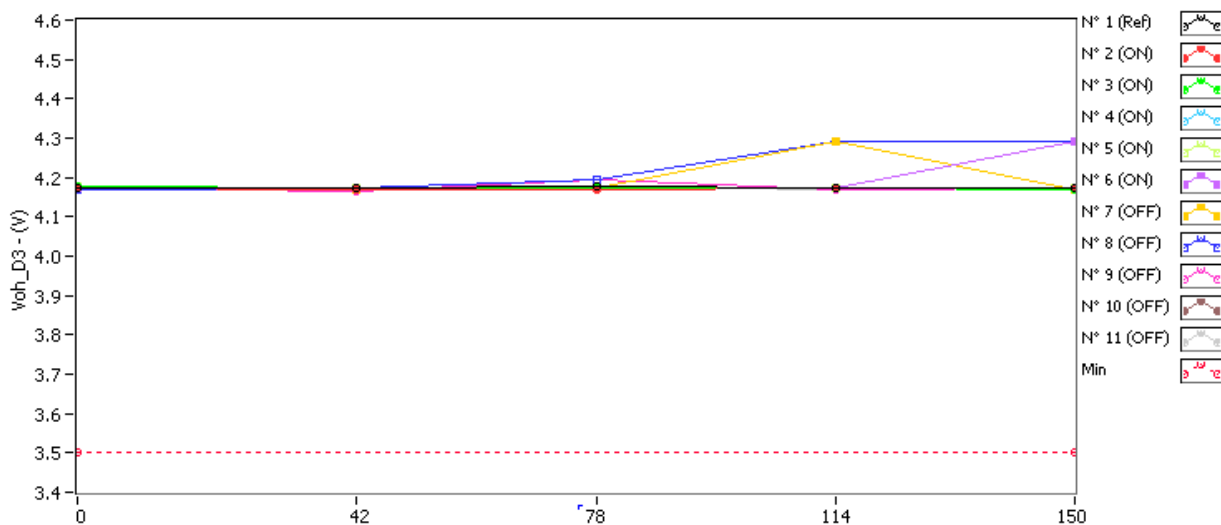

Voh_D3 . (V) Min = 3.5

	0krad(Si)	42krad(Si)	78krad(Si)	114krad(Si)	150krad(Si)
N° 1 (Ref)	4.175	4.172	4.175	4.171	4.172
N° 2 (ON)	4.175	4.170	4.171	4.173	4.173
N° 3 (ON)	4.176	4.173	4.175	4.174	4.167
N° 4 (ON)	4.174	4.174	4.177	4.173	4.174
N° 5 (ON)	4.177	4.174	4.174	4.175	4.175
N° 6 (ON)	4.174	4.172	4.173	4.172	4.291
N° 7 (OFF)	4.173	4.167	4.174	4.290	4.171
N° 8 (OFF)	4.169	4.173	4.194	4.291	4.293
N° 9 (OFF)	4.174	4.163	4.193	4.170	4.172
N° 10 (OFF)	4.176	4.174	4.175	4.171	4.171
N° 11 (OFF)	4.177	4.173	4.176	4.169	4.173

Delta [Voh_D3]

	0krad(Si)	42krad(Si)	78krad(Si)	114krad(Si)	150krad(Si)
N° 1 (Ref)	---	-3.230E-3	1.000E-4	-3.850E-3	-3.720E-3
N° 2 (ON)	---	-4.970E-3	-4.370E-3	-2.580E-3	-2.110E-3
N° 3 (ON)	---	-3.080E-3	-8.500E-4	-2.160E-3	-9.250E-3
N° 4 (ON)	---	-1.700E-4	2.970E-3	-5.800E-4	1.800E-4
N° 5 (ON)	---	-2.300E-3	-2.740E-3	-1.300E-3	-1.350E-3
N° 6 (ON)	---	-2.340E-3	-1.110E-3	-1.610E-3	1.171E-1
N° 7 (OFF)	---	-5.600E-3	8.800E-4	1.172E-1	-1.590E-3
N° 8 (OFF)	---	3.220E-3	2.497E-2	1.215E-1	1.235E-1
N° 9 (OFF)	---	-1.113E-2	1.910E-2	-4.410E-3	-2.580E-3
N° 10 (OFF)	---	-1.620E-3	-9.900E-4	-4.480E-3	-4.220E-3
N° 11 (OFF)	---	-3.370E-3	-6.800E-4	-7.550E-3	-3.930E-3
Average (ON)	---	-2.572E-3	-1.220E-3	-1.646E-3	2.091E-2
s (ON)	---	1.725E-3	2.736E-3	7.736E-4	5.387E-2
Average+3s (ON)	---	2.604E-3	6.987E-3	6.748E-4	1.825E-1
Average-3s (ON)	---	-7.748E-3	-9.427E-3	-3.967E-3	-1.407E-1
Average (OFF)	---	-3.700E-3	8.656E-3	4.445E-2	2.224E-2
s (OFF)	---	5.271E-3	1.241E-2	6.840E-2	5.663E-2
Average+3s (OFF)	---	1.211E-2	4.588E-2	2.496E-1	1.921E-1
Average-3s (OFF)	---	-1.951E-2	-2.857E-2	-1.607E-1	-1.477E-1

13. Voh_D4

Ta = 25°C; AVcc = DVcc = +5V; Vref tied to Voffset through 50 ohms; loh= 10µA

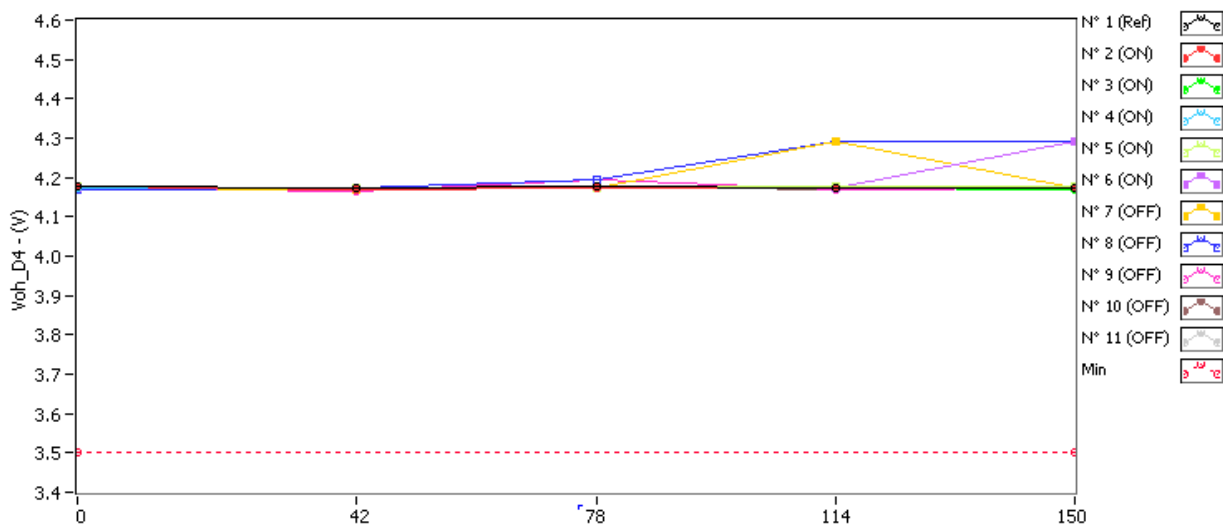

Voh_D4 . (V) Min = 3.5

	0krad(Si)	42krad(Si)	78krad(Si)	114krad(Si)	150krad(Si)
N° 1 (Ref)	4.176	4.173	4.176	4.172	4.172
N° 2 (ON)	4.176	4.171	4.171	4.173	4.173
N° 3 (ON)	4.176	4.173	4.176	4.174	4.168
N° 4 (ON)	4.175	4.174	4.177	4.174	4.175
N° 5 (ON)	4.177	4.175	4.175	4.176	4.176
N° 6 (ON)	4.174	4.172	4.173	4.173	4.291
N° 7 (OFF)	4.173	4.169	4.174	4.290	4.172
N° 8 (OFF)	4.171	4.173	4.195	4.291	4.293
N° 9 (OFF)	4.175	4.163	4.194	4.170	4.172
N° 10 (OFF)	4.177	4.175	4.176	4.171	4.172
N° 11 (OFF)	4.177	4.174	4.176	4.170	4.173

Delta [Voh_D4]

	0krad(Si)	42krad(Si)	78krad(Si)	114krad(Si)	150krad(Si)
N° 1 (Ref)	---	-3.140E-3	4.000E-5	-3.750E-3	-3.700E-3
N° 2 (ON)	---	-4.970E-3	-4.300E-3	-2.510E-3	-2.220E-3
N° 3 (ON)	---	-3.000E-3	-7.900E-4	-2.150E-3	-8.180E-3
N° 4 (ON)	---	-2.100E-4	2.950E-3	-5.600E-4	1.300E-4
N° 5 (ON)	---	-2.260E-3	-2.660E-3	-1.290E-3	-1.340E-3
N° 6 (ON)	---	-2.360E-3	-8.500E-4	-1.500E-3	1.171E-1
N° 7 (OFF)	---	-4.760E-3	8.700E-4	1.171E-1	-1.600E-3
N° 8 (OFF)	---	2.380E-3	2.414E-2	1.206E-1	1.227E-1
N° 9 (OFF)	---	-1.178E-2	1.906E-2	-4.430E-3	-2.650E-3
N° 10 (OFF)	---	-1.630E-3	-9.700E-4	-5.650E-3	-4.240E-3
N° 11 (OFF)	---	-3.350E-3	-6.300E-4	-7.440E-3	-3.860E-3
Average (ON)	---	-2.560E-3	-1.130E-3	-1.602E-3	2.110E-2
s (ON)	---	1.707E-3	2.703E-3	7.613E-4	5.376E-2
Average+3s (ON)	---	2.561E-3	6.980E-3	6.819E-4	1.824E-1
Average-3s (ON)	---	-7.681E-3	-9.240E-3	-3.886E-3	-1.402E-1
Average (OFF)	---	-3.828E-3	8.494E-3	4.405E-2	2.206E-2
s (OFF)	---	5.189E-3	1.212E-2	6.833E-2	5.625E-2
Average+3s (OFF)	---	1.174E-2	4.485E-2	2.490E-1	1.908E-1
Average-3s (OFF)	---	-1.939E-2	-2.786E-2	-1.609E-1	-1.467E-1

14. Voh_D5

Ta = 25°C; AVcc = DVcc = +5V; Vref tied to Voffset through 50 ohms; loh= 10µA

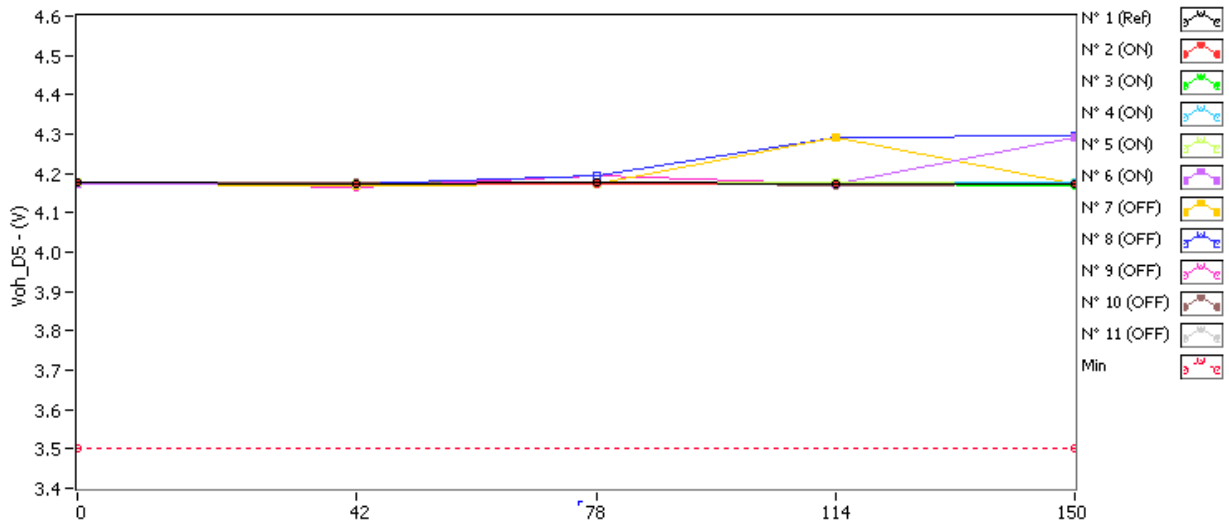

Voh_D5 . (V) Min = 3.5

	0krad(Si)	42krad(Si)	78krad(Si)	114krad(Si)	150krad(Si)
N° 1 (Ref)	4.177	4.174	4.177	4.173	4.173
N° 2 (ON)	4.176	4.171	4.172	4.174	4.174
N° 3 (ON)	4.177	4.174	4.176	4.175	4.170
N° 4 (ON)	4.176	4.175	4.178	4.175	4.176
N° 5 (ON)	4.177	4.175	4.175	4.176	4.176
N° 6 (ON)	4.175	4.173	4.174	4.174	4.292
N° 7 (OFF)	4.174	4.170	4.175	4.291	4.172
N° 8 (OFF)	4.172	4.174	4.196	4.292	4.294
N° 9 (OFF)	4.176	4.164	4.195	4.171	4.173
N° 10 (OFF)	4.177	4.176	4.176	4.168	4.173
N° 11 (OFF)	4.178	4.174	4.177	4.170	4.174

Delta [Voh_D5]

	0krad(Si)	42krad(Si)	78krad(Si)	114krad(Si)	150krad(Si)
N° 1 (Ref)	---	-3.120E-3	1.000E-5	-3.710E-3	-3.670E-3
N° 2 (ON)	---	-4.880E-3	-4.150E-3	-2.410E-3	-2.300E-3
N° 3 (ON)	---	-2.910E-3	-7.500E-4	-2.070E-3	-7.210E-3
N° 4 (ON)	---	-2.500E-4	2.920E-3	-5.500E-4	1.400E-4
N° 5 (ON)	---	-2.170E-3	-2.550E-3	-1.240E-3	-1.260E-3
N° 6 (ON)	---	-2.390E-3	-7.100E-4	-1.530E-3	1.171E-1
N° 7 (OFF)	---	-4.120E-3	9.000E-4	1.171E-1	-1.600E-3
N° 8 (OFF)	---	1.720E-3	2.349E-2	1.199E-1	1.220E-1
N° 9 (OFF)	---	-1.134E-2	1.912E-2	-4.390E-3	-2.620E-3
N° 10 (OFF)	---	-1.620E-3	-9.500E-4	-9.280E-3	-4.190E-3
N° 11 (OFF)	---	-3.330E-3	-5.900E-4	-7.350E-3	-3.830E-3
Average (ON)	---	-2.520E-3	-1.048E-3	-1.560E-3	2.130E-2
s (ON)	---	1.659E-3	2.638E-3	7.256E-4	5.363E-2
Average+3s (ON)	---	2.458E-3	6.865E-3	6.168E-4	1.822E-1
Average-3s (ON)	---	-7.498E-3	-8.961E-3	-3.737E-3	-1.396E-1
Average (OFF)	---	-3.738E-3	8.394E-3	4.320E-2	2.195E-2
s (OFF)	---	4.806E-3	1.191E-2	6.878E-2	5.592E-2
Average+3s (OFF)	---	1.068E-2	4.412E-2	2.495E-1	1.897E-1
Average-3s (OFF)	---	-1.816E-2	-2.733E-2	-1.631E-1	-1.458E-1

15. Voh_D6

Ta = 25°C; AVcc = DVcc = +5V; Vref tied to Voffset through 50 ohms; loh= 10µA

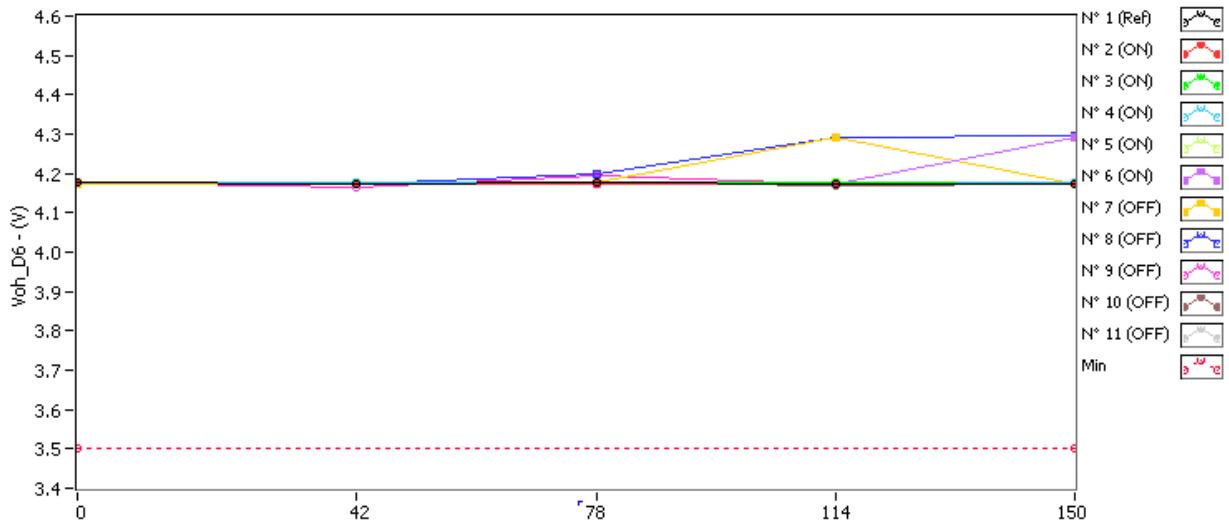

Voh_D6 . (V) **Min = 3.5**

	0krad(Si)	42krad(Si)	78krad(Si)	114krad(Si)	150krad(Si)
N° 1 (Ref)	4.177	4.174	4.178	4.174	4.174
N° 2 (ON)	4.177	4.172	4.173	4.175	4.175
N° 3 (ON)	4.178	4.175	4.177	4.176	4.171
N° 4 (ON)	4.176	4.176	4.179	4.176	4.177
N° 5 (ON)	4.178	4.176	4.176	4.177	4.177
N° 6 (ON)	4.176	4.173	4.175	4.174	4.293
N° 7 (OFF)	4.175	4.171	4.176	4.292	4.173
N° 8 (OFF)	4.174	4.175	4.197	4.293	4.295
N° 9 (OFF)	4.176	4.165	4.195	4.172	4.174
N° 10 (OFF)	4.178	4.176	4.177	4.169	4.174
N° 11 (OFF)	4.179	4.175	4.178	4.171	4.175

Delta [Voh_D6]

	0krad(Si)	42krad(Si)	78krad(Si)	114krad(Si)	150krad(Si)
N° 1 (Ref)	---	-3.000E-3	9.000E-5	-3.630E-3	-3.580E-3
N° 2 (ON)	---	-4.840E-3	-4.040E-3	-2.420E-3	-2.400E-3
N° 3 (ON)	---	-2.850E-3	-7.300E-4	-2.020E-3	-6.570E-3
N° 4 (ON)	---	-2.800E-4	2.830E-3	-5.400E-4	1.200E-4
N° 5 (ON)	---	-2.130E-3	-2.400E-3	-1.160E-3	-1.190E-3
N° 6 (ON)	---	-2.410E-3	-5.600E-4	-1.530E-3	1.170E-1
N° 7 (OFF)	---	-3.710E-3	9.100E-4	1.171E-1	-1.600E-3
N° 8 (OFF)	---	1.320E-3	2.310E-2	1.195E-1	1.215E-1
N° 9 (OFF)	---	-1.083E-2	1.922E-2	-4.360E-3	-2.520E-3
N° 10 (OFF)	---	-1.630E-3	-1.000E-3	-9.260E-3	-4.140E-3
N° 11 (OFF)	---	-3.250E-3	-5.500E-4	-7.230E-3	-3.780E-3
Average (ON)	---	-2.502E-3	-9.800E-4	-1.534E-3	2.140E-2
s (ON)	---	1.633E-3	2.556E-3	7.330E-4	5.353E-2
Average+3s (ON)	---	2.398E-3	6.688E-3	6.650E-4	1.820E-1
Average-3s (ON)	---	-7.402E-3	-8.648E-3	-3.733E-3	-1.392E-1
Average (OFF)	---	-3.620E-3	8.336E-3	4.315E-2	2.190E-2
s (OFF)	---	4.486E-3	1.181E-2	6.864E-2	5.570E-2
Average+3s (OFF)	---	9.838E-3	4.376E-2	2.491E-1	1.890E-1
Average-3s (OFF)	---	-1.708E-2	-2.709E-2	-1.628E-1	-1.452E-1

16. Voh_D7

Ta = 25°C; AVcc = DVcc = +5V; Vref tied to Voffset through 50 ohms; loh= 10µA

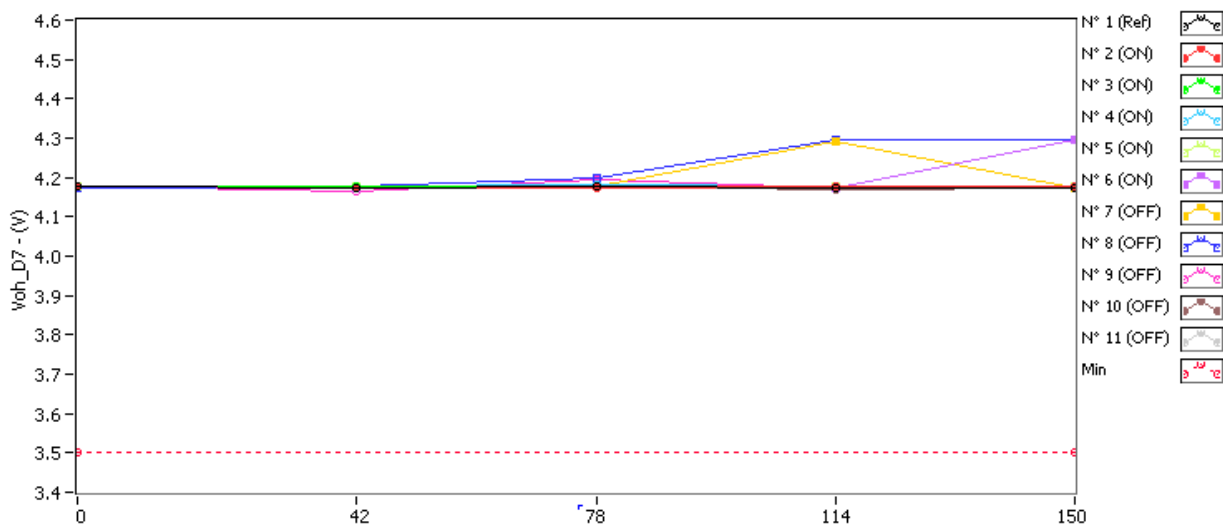

Voh_D7 . (V) Min = 3.5

	0krad(Si)	42krad(Si)	78krad(Si)	114krad(Si)	150krad(Si)
N° 1 (Ref)	4.178	4.175	4.178	4.174	4.175
N° 2 (ON)	4.178	4.173	4.174	4.175	4.175
N° 3 (ON)	4.179	4.176	4.178	4.177	4.173
N° 4 (ON)	4.177	4.176	4.180	4.176	4.177
N° 5 (ON)	4.179	4.177	4.177	4.178	4.178
N° 6 (ON)	4.177	4.174	4.176	4.175	4.294
N° 7 (OFF)	4.175	4.172	4.176	4.293	4.174
N° 8 (OFF)	4.175	4.176	4.197	4.294	4.296
N° 9 (OFF)	4.177	4.167	4.196	4.173	4.175
N° 10 (OFF)	4.179	4.177	4.178	4.170	4.174
N° 11 (OFF)	4.179	4.176	4.179	4.172	4.176

Delta [Voh_D7]

	0krad(Si)	42krad(Si)	78krad(Si)	114krad(Si)	150krad(Si)
N° 1 (Ref)	---	-2.990E-3	1.200E-4	-3.610E-3	-3.570E-3
N° 2 (ON)	---	-4.800E-3	-3.970E-3	-2.350E-3	-2.350E-3
N° 3 (ON)	---	-2.790E-3	-7.400E-4	-2.010E-3	-6.010E-3
N° 4 (ON)	---	-3.500E-4	2.780E-3	-5.700E-4	3.000E-5
N° 5 (ON)	---	-2.060E-3	-2.270E-3	-1.090E-3	-1.160E-3
N° 6 (ON)	---	-2.400E-3	-3.100E-4	-1.480E-3	1.172E-1
N° 7 (OFF)	---	-3.250E-3	9.900E-4	1.172E-1	-1.550E-3
N° 8 (OFF)	---	9.400E-4	2.272E-2	1.192E-1	1.211E-1
N° 9 (OFF)	---	-1.039E-2	1.923E-2	-4.360E-3	-2.500E-3
N° 10 (OFF)	---	-1.670E-3	-1.030E-3	-8.340E-3	-4.160E-3
N° 11 (OFF)	---	-3.200E-3	-5.100E-4	-7.120E-3	-3.710E-3
Average (ON)	---	-2.480E-3	-9.020E-4	-1.500E-3	2.153E-2
s (ON)	---	1.597E-3	2.511E-3	7.099E-4	5.350E-2
Average+3s (ON)	---	2.310E-3	6.631E-3	6.298E-4	1.820E-1
Average-3s (ON)	---	-7.270E-3	-8.435E-3	-3.630E-3	-1.390E-1
Average (OFF)	---	-3.514E-3	8.280E-3	4.330E-2	2.184E-2
s (OFF)	---	4.204E-3	1.168E-2	6.836E-2	5.552E-2
Average+3s (OFF)	---	9.097E-3	4.331E-2	2.484E-1	1.884E-1
Average-3s (OFF)	---	-1.613E-2	-2.675E-2	-1.618E-1	-1.447E-1

17. Voh_D8

Ta = 25°C; AVcc = DVcc = +5V; Vref tied to Voffset through 50 ohms; loh= 10µA

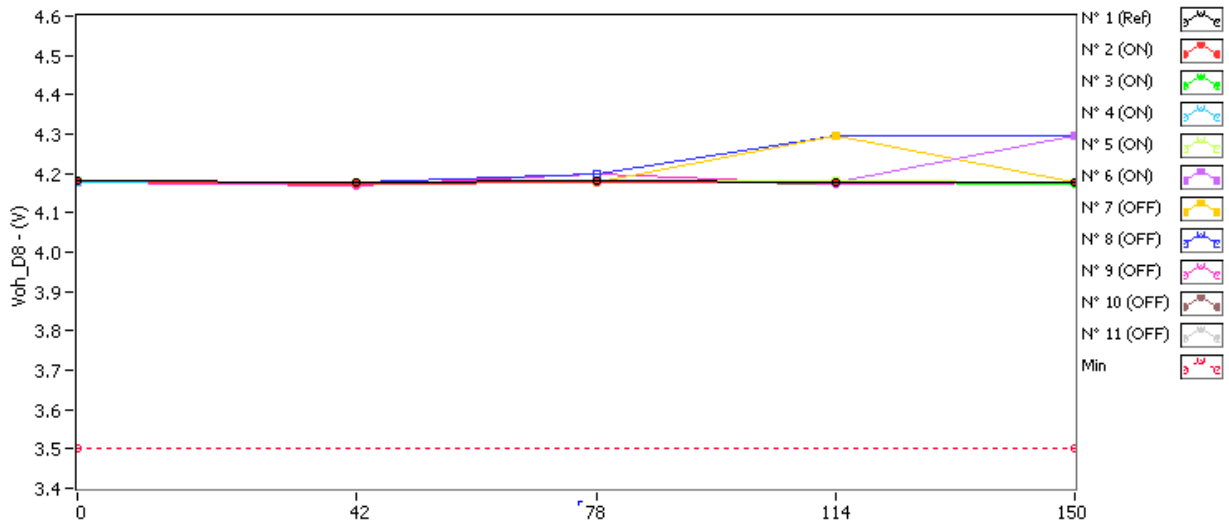

Voh_D8 . (V) Min = 3.5

	0krad(Si)	42krad(Si)	78krad(Si)	114krad(Si)	150krad(Si)
N° 1 (Ref)	4.181	4.178	4.181	4.177	4.177
N° 2 (ON)	4.180	4.175	4.176	4.178	4.177
N° 3 (ON)	4.181	4.178	4.180	4.178	4.175
N° 4 (ON)	4.178	4.178	4.181	4.177	4.178
N° 5 (ON)	4.181	4.179	4.179	4.180	4.180
N° 6 (ON)	4.179	4.176	4.179	4.177	4.296
N° 7 (OFF)	4.178	4.175	4.179	4.296	4.177
N° 8 (OFF)	4.177	4.177	4.199	4.295	4.297
N° 9 (OFF)	4.179	4.169	4.198	4.174	4.176
N° 10 (OFF)	4.181	4.179	4.180	4.173	4.176
N° 11 (OFF)	4.181	4.178	4.181	4.174	4.178

Delta [Voh_D8]

	0krad(Si)	42krad(Si)	78krad(Si)	114krad(Si)	150krad(Si)
N° 1 (Ref)	---	-3.040E-3	8.000E-5	-3.600E-3	-3.620E-3
N° 2 (ON)	---	-4.820E-3	-3.930E-3	-2.270E-3	-2.390E-3
N° 3 (ON)	---	-2.890E-3	-7.600E-4	-2.080E-3	-5.610E-3
N° 4 (ON)	---	-3.900E-4	2.720E-3	-5.800E-4	6.000E-5
N° 5 (ON)	---	-2.130E-3	-2.160E-3	-1.130E-3	-1.210E-3
N° 6 (ON)	---	-2.380E-3	-2.500E-4	-1.520E-3	1.171E-1
N° 7 (OFF)	---	-2.940E-3	1.000E-3	1.172E-1	-1.550E-3
N° 8 (OFF)	---	6.000E-4	2.245E-2	1.188E-1	1.208E-1
N° 9 (OFF)	---	-1.005E-2	1.927E-2	-4.320E-3	-2.500E-3
N° 10 (OFF)	---	-1.690E-3	-9.900E-4	-7.780E-3	-4.140E-3
N° 11 (OFF)	---	-3.120E-3	-4.600E-4	-6.990E-3	-3.680E-3
Average (ON)	---	-2.522E-3	-8.760E-4	-1.516E-3	2.160E-2
s (ON)	---	1.592E-3	2.465E-3	6.913E-4	5.345E-2
Average+3s (ON)	---	2.253E-3	6.520E-3	5.580E-4	1.819E-1
Average-3s (ON)	---	-7.297E-3	-8.272E-3	-3.590E-3	-1.387E-1
Average (OFF)	---	-3.440E-3	8.254E-3	4.338E-2	2.180E-2
s (OFF)	---	3.982E-3	1.159E-2	6.813E-2	5.538E-2
Average+3s (OFF)	---	8.506E-3	4.301E-2	2.478E-1	1.879E-1
Average-3s (OFF)	---	-1.539E-2	-2.650E-2	-1.610E-1	-1.444E-1

18. Voh_D9

Ta = 25°C; AVcc = DVcc = +5V; Vref tied to Voffset through 50 ohms; loh= 10µA

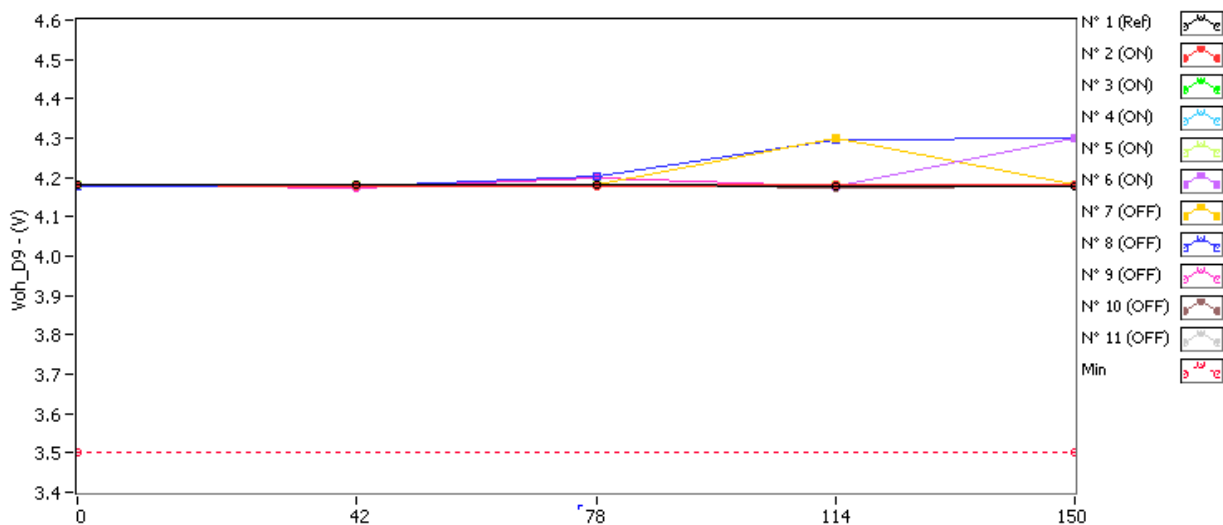

Voh_D9 . (V) Min = 3.5

	0krad(Si)	42krad(Si)	78krad(Si)	114krad(Si)	150krad(Si)
N° 1 (Ref)	4.183	4.180	4.183	4.179	4.179
N° 2 (ON)	4.182	4.178	4.178	4.180	4.180
N° 3 (ON)	4.183	4.180	4.182	4.181	4.178
N° 4 (ON)	4.180	4.180	4.183	4.179	4.180
N° 5 (ON)	4.183	4.181	4.181	4.182	4.181
N° 6 (ON)	4.181	4.179	4.181	4.180	4.298
N° 7 (OFF)	4.181	4.179	4.182	4.298	4.180
N° 8 (OFF)	4.179	4.179	4.201	4.297	4.299
N° 9 (OFF)	4.181	4.173	4.201	4.177	4.179
N° 10 (OFF)	4.183	4.181	4.182	4.175	4.179
N° 11 (OFF)	4.183	4.180	4.183	4.176	4.179

Delta [Voh_D9]

	0krad(Si)	42krad(Si)	78krad(Si)	114krad(Si)	150krad(Si)
N° 1 (Ref)	---	-3.050E-3	1.000E-4	-3.570E-3	-3.580E-3
N° 2 (ON)	---	-4.810E-3	-3.940E-3	-2.250E-3	-2.340E-3
N° 3 (ON)	---	-2.980E-3	-8.400E-4	-2.120E-3	-5.360E-3
N° 4 (ON)	---	-4.700E-4	2.750E-3	-5.500E-4	-3.000E-5
N° 5 (ON)	---	-2.170E-3	-2.110E-3	-1.160E-3	-1.270E-3
N° 6 (ON)	---	-2.350E-3	-2.300E-4	-1.500E-3	1.172E-1
N° 7 (OFF)	---	-2.590E-3	9.700E-4	1.172E-1	-1.560E-3
N° 8 (OFF)	---	2.300E-4	2.213E-2	1.185E-1	1.205E-1
N° 9 (OFF)	---	-8.550E-3	1.924E-2	-4.310E-3	-2.550E-3
N° 10 (OFF)	---	-1.710E-3	-9.700E-4	-7.570E-3	-4.120E-3
N° 11 (OFF)	---	-3.120E-3	-4.200E-4	-6.960E-3	-3.670E-3
Average (ON)	---	-2.556E-3	-8.740E-4	-1.516E-3	2.163E-2
s (ON)	---	1.565E-3	2.474E-3	7.007E-4	5.344E-2
Average+3s (ON)	---	2.140E-3	6.547E-3	5.860E-4	1.820E-1
Average-3s (ON)	---	-7.252E-3	-8.295E-3	-3.618E-3	-1.387E-1
Average (OFF)	---	-3.148E-3	8.190E-3	4.337E-2	2.172E-2
s (OFF)	---	3.278E-3	1.147E-2	6.800E-2	5.523E-2
Average+3s (OFF)	---	6.685E-3	4.261E-2	2.474E-1	1.874E-1
Average-3s (OFF)	---	-1.298E-2	-2.623E-2	-1.606E-1	-1.440E-1

19. Voh_D10

Ta = 25°C; AVcc = DVcc = +5V; Vref tied to Voffset through 50 ohms; loh= 10µA

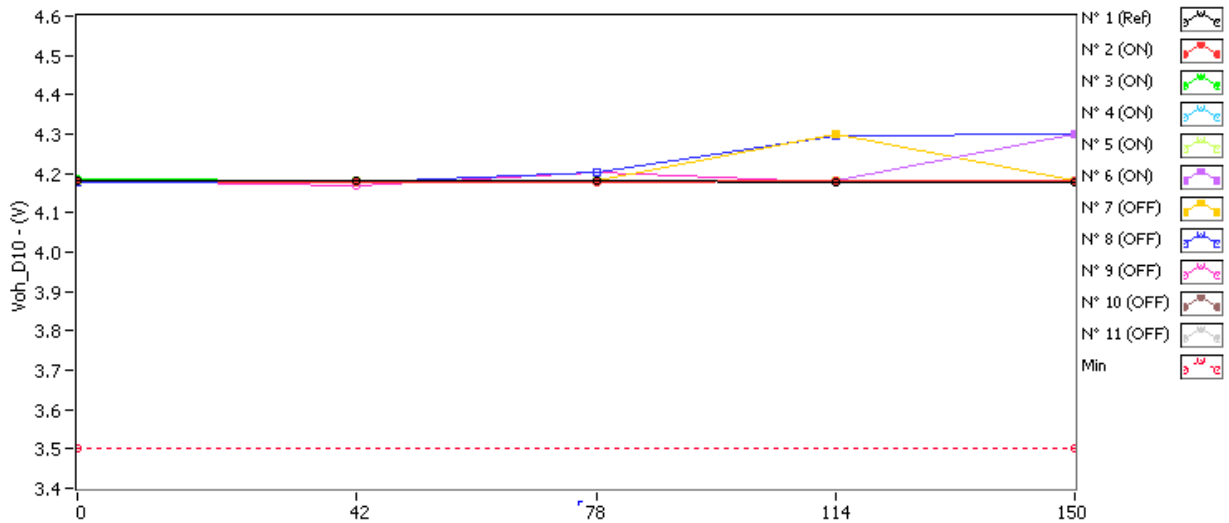

Voh_D10 . (V)

Min = 3.5

	0krad(Si)	42krad(Si)	78krad(Si)	114krad(Si)	150krad(Si)
N° 1 (Ref)	4.183	4.180	4.183	4.179	4.179
N° 2 (ON)	4.183	4.178	4.179	4.181	4.180
N° 3 (ON)	4.184	4.181	4.183	4.182	4.179
N° 4 (ON)	4.181	4.180	4.183	4.180	4.181
N° 5 (ON)	4.183	4.181	4.181	4.182	4.182
N° 6 (ON)	4.181	4.179	4.181	4.180	4.298
N° 7 (OFF)	4.181	4.179	4.182	4.298	4.180
N° 8 (OFF)	4.179	4.179	4.201	4.298	4.300
N° 9 (OFF)	4.182	4.171	4.201	4.177	4.179
N° 10 (OFF)	4.183	4.182	4.182	4.176	4.179
N° 11 (OFF)	4.184	4.181	4.183	4.177	4.180

Delta [Voh_D10]

	0krad(Si)	42krad(Si)	78krad(Si)	114krad(Si)	150krad(Si)
N° 1 (Ref)	---	-3.110E-3	1.100E-4	-3.580E-3	-3.610E-3
N° 2 (ON)	---	-4.740E-3	-3.770E-3	-2.220E-3	-2.320E-3
N° 3 (ON)	---	-3.020E-3	-7.500E-4	-2.120E-3	-5.070E-3
N° 4 (ON)	---	-4.900E-4	2.750E-3	-5.500E-4	-3.000E-5
N° 5 (ON)	---	-2.110E-3	-1.990E-3	-1.080E-3	-1.190E-3
N° 6 (ON)	---	-2.360E-3	-2.300E-4	-1.510E-3	1.171E-1
N° 7 (OFF)	---	-2.320E-3	9.500E-4	1.172E-1	-1.560E-3
N° 8 (OFF)	---	0.000E+0	2.191E-2	1.183E-1	1.202E-1
N° 9 (OFF)	---	-1.082E-2	1.920E-2	-4.330E-3	-2.560E-3
N° 10 (OFF)	---	-1.760E-3	-9.600E-4	-7.600E-3	-4.100E-3
N° 11 (OFF)	---	-3.080E-3	-4.000E-4	-6.870E-3	-3.640E-3
Average (ON)	---	-2.544E-3	-7.980E-4	-1.496E-3	2.170E-2
s (ON)	---	1.540E-3	2.407E-3	7.039E-4	5.338E-2
Average+3s (ON)	---	2.077E-3	6.422E-3	6.156E-4	1.818E-1
Average-3s (ON)	---	-7.165E-3	-8.018E-3	-3.608E-3	-1.384E-1
Average (OFF)	---	-3.596E-3	8.140E-3	4.333E-2	2.167E-2
s (OFF)	---	4.195E-3	1.139E-2	6.793E-2	5.509E-2
Average+3s (OFF)	---	8.988E-3	4.232E-2	2.471E-1	1.870E-1
Average-3s (OFF)	---	-1.618E-2	-2.604E-2	-1.605E-1	-1.436E-1

20. Voh_D11

Ta = 25°C; AVcc = DVcc = +5V; Vref tied to Voffset through 50 ohms; loh= 10µA

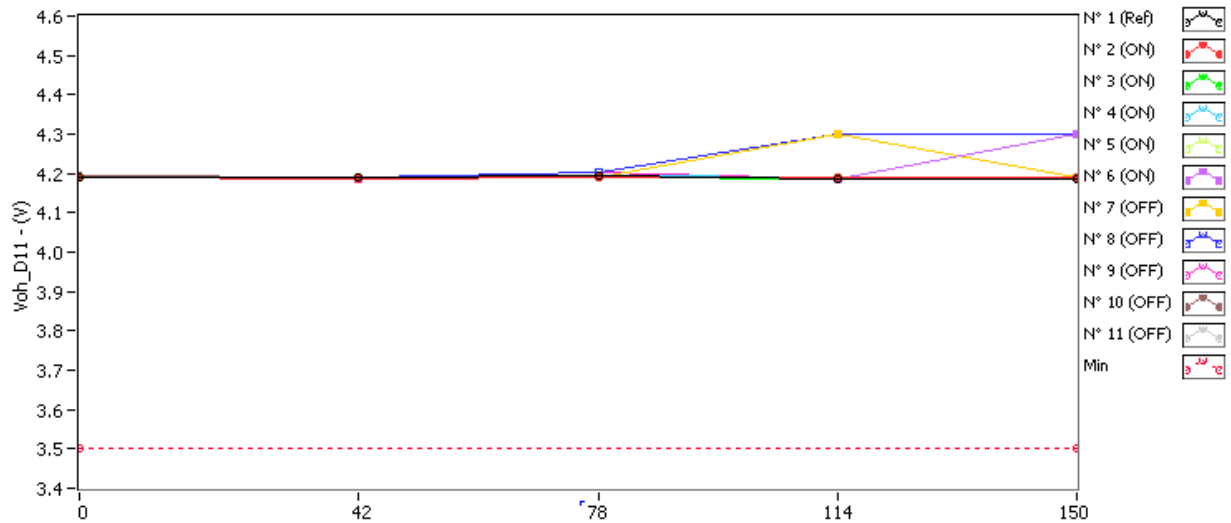

Voh_D11 . (V)

Min = 3.5

	0krad(Si)	42krad(Si)	78krad(Si)	114krad(Si)	150krad(Si)
N° 1 (Ref)	4.192	4.190	4.193	4.188	4.188
N° 2 (ON)	4.192	4.187	4.189	4.190	4.189
N° 3 (ON)	4.192	4.190	4.192	4.188	4.189
N° 4 (ON)	4.190	4.190	4.193	4.189	4.190
N° 5 (ON)	4.192	4.190	4.191	4.191	4.191
N° 6 (ON)	4.189	4.187	4.189	4.188	4.299
N° 7 (OFF)	4.191	4.190	4.192	4.299	4.190
N° 8 (OFF)	4.191	4.190	4.204	4.300	4.302
N° 9 (OFF)	4.191	4.189	4.203	4.187	4.189
N° 10 (OFF)	4.193	4.188	4.193	4.186	4.190
N° 11 (OFF)	4.192	4.186	4.193	4.188	4.190

Delta [Voh_D11]

	0krad(Si)	42krad(Si)	78krad(Si)	114krad(Si)	150krad(Si)
N° 1 (Ref)	---	-1.940E-3	1.400E-3	-3.810E-3	-4.080E-3
N° 2 (ON)	---	-4.530E-3	-3.310E-3	-2.290E-3	-2.530E-3
N° 3 (ON)	---	-1.750E-3	-1.200E-4	-3.810E-3	-2.770E-3
N° 4 (ON)	---	-5.700E-4	2.700E-3	-6.000E-4	2.300E-4
N° 5 (ON)	---	-1.600E-3	-1.040E-3	-8.200E-4	-1.090E-3
N° 6 (ON)	---	-1.850E-3	8.000E-5	-1.210E-3	1.098E-1
N° 7 (OFF)	---	-7.000E-4	1.420E-3	1.082E-1	-9.500E-4
N° 8 (OFF)	---	-1.030E-3	1.317E-2	1.091E-1	1.111E-1
N° 9 (OFF)	---	-1.890E-3	1.188E-2	-3.530E-3	-1.590E-3
N° 10 (OFF)	---	-4.660E-3	-3.200E-4	-6.470E-3	-2.680E-3
N° 11 (OFF)	---	-6.540E-3	5.400E-4	-4.240E-3	-2.440E-3
Average (ON)	---	-2.060E-3	-3.380E-4	-1.746E-3	2.074E-2
s (ON)	---	1.472E-3	2.167E-3	1.324E-3	4.983E-2
Average+3s (ON)	---	2.357E-3	6.162E-3	2.227E-3	1.702E-1
Average-3s (ON)	---	-6.477E-3	-6.838E-3	-5.719E-3	-1.287E-1
Average (OFF)	---	-2.964E-3	5.338E-3	4.060E-2	2.068E-2
s (OFF)	---	2.534E-3	6.605E-3	6.210E-2	5.053E-2
Average+3s (OFF)	---	4.638E-3	2.515E-2	2.269E-1	1.723E-1
Average-3s (OFF)	---	-1.057E-2	-1.448E-2	-1.457E-1	-1.309E-1

21. Vol_D0

Ta = 25°C; AVcc = DVcc = +5V; Vref tied to Voffset through 50 ohms; Iol= 10µA

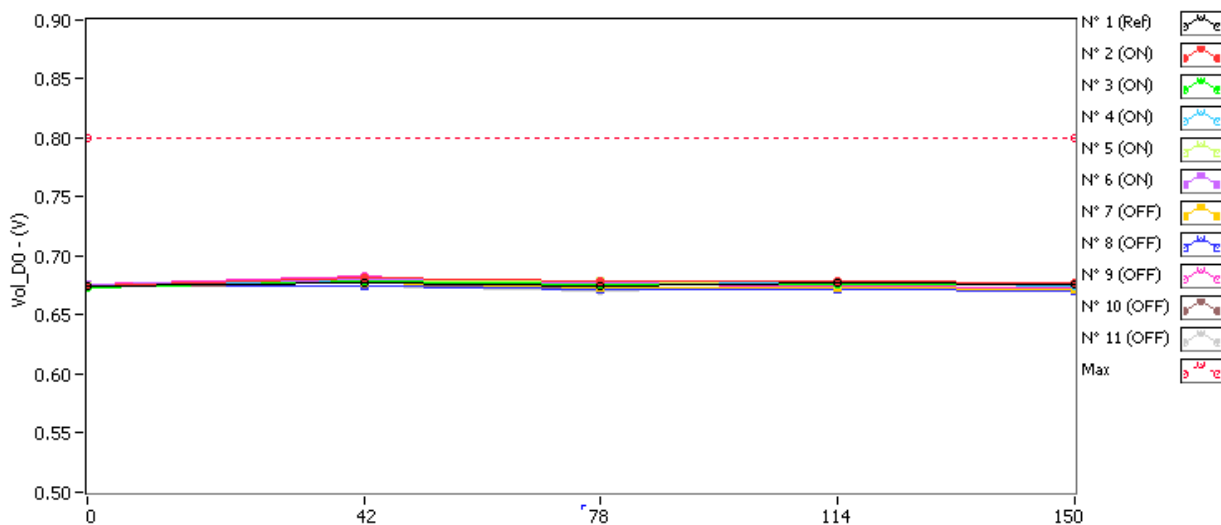

Vol_D0 . (V) Max = 0.8

	0krad(Si)	42krad(Si)	78krad(Si)	114krad(Si)	150krad(Si)
N° 1 (Ref)	0.674	0.678	0.675	0.677	0.676
N° 2 (ON)	0.674	0.682	0.679	0.679	0.678
N° 3 (ON)	0.674	0.679	0.676	0.677	0.676
N° 4 (ON)	0.675	0.679	0.675	0.678	0.675
N° 5 (ON)	0.674	0.679	0.678	0.677	0.676
N° 6 (ON)	0.676	0.681	0.678	0.678	0.676
N° 7 (OFF)	0.675	0.677	0.673	0.673	0.672
N° 8 (OFF)	0.675	0.675	0.671	0.672	0.670
N° 9 (OFF)	0.676	0.683	0.674	0.674	0.673
N° 10 (OFF)	0.675	0.675	0.673	0.672	0.672
N° 11 (OFF)	0.674	0.675	0.671	0.674	0.671

Delta [Vol_D0]

	0krad(Si)	42krad(Si)	78krad(Si)	114krad(Si)	150krad(Si)
N° 1 (Ref)	---	3.721E-3	1.115E-3	3.518E-3	2.323E-3
N° 2 (ON)	---	7.600E-3	4.748E-3	4.487E-3	3.277E-3
N° 3 (ON)	---	5.167E-3	2.267E-3	2.898E-3	2.560E-3
N° 4 (ON)	---	4.625E-3	9.070E-4	3.431E-3	5.560E-4
N° 5 (ON)	---	4.886E-3	3.904E-3	2.382E-3	1.735E-3
N° 6 (ON)	---	4.707E-3	2.208E-3	2.117E-3	2.750E-4
N° 7 (OFF)	---	2.421E-3	-2.076E-3	-2.272E-3	-3.029E-3
N° 8 (OFF)	---	-5.950E-4	-4.149E-3	-3.963E-3	-5.604E-3
N° 9 (OFF)	---	7.471E-3	-2.079E-3	-1.472E-3	-2.901E-3
N° 10 (OFF)	---	4.910E-4	-2.068E-3	-2.916E-3	-2.777E-3
N° 11 (OFF)	---	1.322E-3	-3.018E-3	2.030E-4	-3.426E-3
Average (ON)	---	5.397E-3	2.807E-3	3.063E-3	1.681E-3
s (ON)	---	1.249E-3	1.519E-3	9.420E-4	1.281E-3
Average+3s (ON)	---	9.144E-3	7.364E-3	5.889E-3	5.524E-3
Average-3s (ON)	---	1.650E-3	-1.751E-3	2.371E-4	-2.163E-3
Average (OFF)	---	2.222E-3	-2.678E-3	-2.084E-3	-3.547E-3
s (OFF)	---	3.136E-3	9.183E-4	1.570E-3	1.175E-3
Average+3s (OFF)	---	1.163E-2	7.676E-5	2.627E-3	-2.178E-5
Average-3s (OFF)	---	-7.185E-3	-5.433E-3	-6.795E-3	-7.073E-3

22. Vol_D1

Ta = 25°C; AVcc = DVcc = +5V; Vref tied to Voffset through 50 ohms; Iol= 10µA

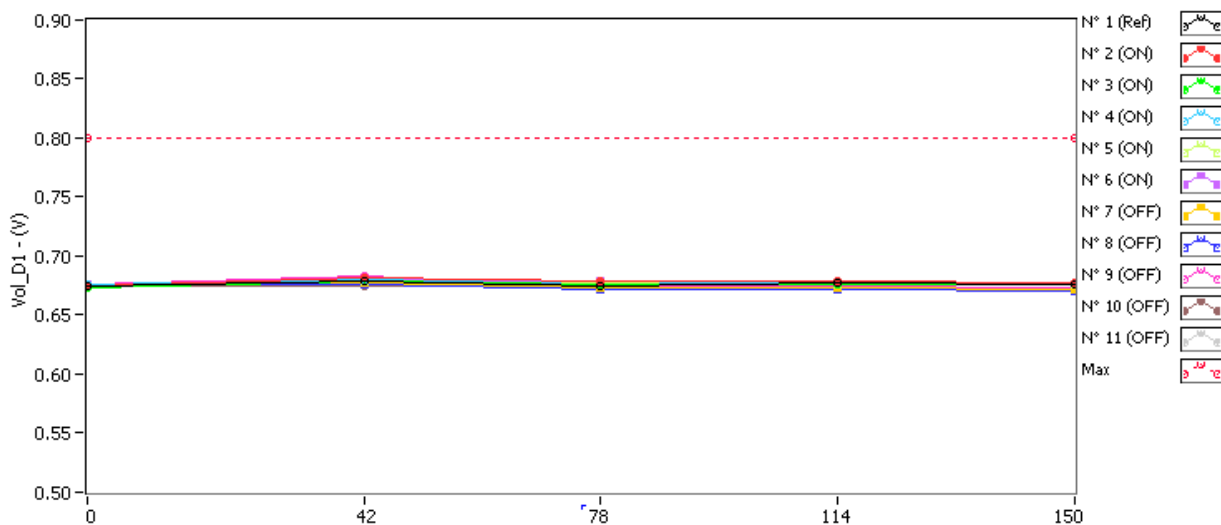

Vol_D1 . (V) Max = 0.8

	0krad(Si)	42krad(Si)	78krad(Si)	114krad(Si)	150krad(Si)
N° 1 (Ref)	0.674	0.678	0.675	0.678	0.677
N° 2 (ON)	0.674	0.682	0.679	0.679	0.678
N° 3 (ON)	0.674	0.679	0.676	0.676	0.676
N° 4 (ON)	0.675	0.680	0.676	0.679	0.677
N° 5 (ON)	0.674	0.679	0.678	0.677	0.676
N° 6 (ON)	0.676	0.681	0.678	0.678	0.676
N° 7 (OFF)	0.676	0.678	0.673	0.673	0.672
N° 8 (OFF)	0.676	0.676	0.672	0.672	0.671
N° 9 (OFF)	0.676	0.682	0.674	0.675	0.673
N° 10 (OFF)	0.675	0.675	0.673	0.672	0.672
N° 11 (OFF)	0.675	0.676	0.672	0.675	0.671

Delta [Vol_D1]

	0krad(Si)	42krad(Si)	78krad(Si)	114krad(Si)	150krad(Si)
N° 1 (Ref)	---	3.703E-3	7.080E-4	3.528E-3	2.232E-3
N° 2 (ON)	---	7.539E-3	4.580E-3	4.389E-3	3.252E-3
N° 3 (ON)	---	5.246E-3	2.381E-3	2.765E-3	2.315E-3
N° 4 (ON)	---	4.676E-3	7.880E-4	3.369E-3	1.725E-3
N° 5 (ON)	---	4.846E-3	3.761E-3	2.297E-3	1.684E-3
N° 6 (ON)	---	4.634E-3	2.222E-3	2.076E-3	3.060E-4
N° 7 (OFF)	---	2.333E-3	-2.152E-3	-2.416E-3	-3.140E-3
N° 8 (OFF)	---	-4.720E-4	-3.811E-3	-3.807E-3	-5.480E-3
N° 9 (OFF)	---	6.120E-3	-2.085E-3	-1.466E-3	-3.064E-3
N° 10 (OFF)	---	8.160E-4	-1.768E-3	-2.630E-3	-2.641E-3
N° 11 (OFF)	---	1.202E-3	-2.689E-3	6.200E-5	-3.530E-3
Average (ON)	---	5.388E-3	2.746E-3	2.979E-3	1.856E-3
s (ON)	---	1.226E-3	1.469E-3	9.309E-4	1.073E-3
Average+3s (ON)	---	9.067E-3	7.154E-3	5.772E-3	5.077E-3
Average-3s (ON)	---	1.709E-3	-1.661E-3	1.864E-4	-1.364E-3
Average (OFF)	---	2.000E-3	-2.501E-3	-2.051E-3	-3.571E-3
s (OFF)	---	2.512E-3	8.037E-4	1.446E-3	1.113E-3
Average+3s (OFF)	---	9.535E-3	-8.997E-5	2.285E-3	-2.325E-4
Average-3s (OFF)	---	-5.535E-3	-4.912E-3	-6.388E-3	-6.910E-3

23. Vol_D2

Ta = 25°C; AVcc = DVcc = +5V; Vref tied to Voffset through 50 ohms; Iol= 10µA

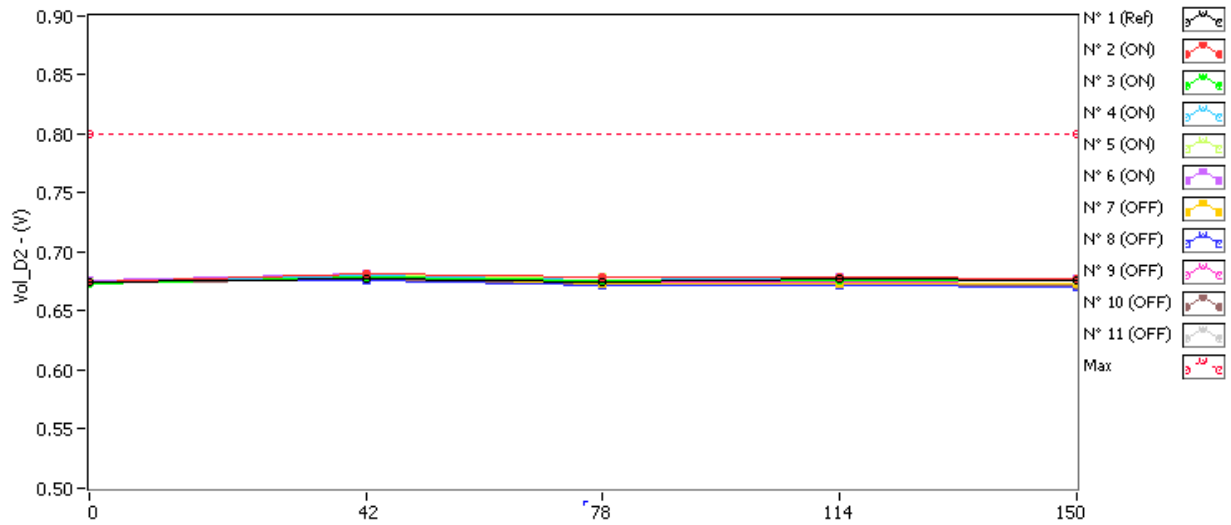

Vol_D2 . (V) Max = 0.8

	0krad(Si)	42krad(Si)	78krad(Si)	114krad(Si)	150krad(Si)
N° 1 (Ref)	0.675	0.678	0.675	0.678	0.677
N° 2 (ON)	0.675	0.682	0.679	0.679	0.678
N° 3 (ON)	0.674	0.679	0.676	0.677	0.676
N° 4 (ON)	0.675	0.680	0.676	0.678	0.677
N° 5 (ON)	0.675	0.680	0.679	0.677	0.677
N° 6 (ON)	0.676	0.681	0.679	0.678	0.677
N° 7 (OFF)	0.676	0.678	0.674	0.674	0.673
N° 8 (OFF)	0.676	0.676	0.673	0.672	0.671
N° 9 (OFF)	0.676	0.681	0.675	0.675	0.674
N° 10 (OFF)	0.675	0.675	0.673	0.672	0.672
N° 11 (OFF)	0.675	0.676	0.672	0.675	0.671

Delta [Vol_D2]

	0krad(Si)	42krad(Si)	78krad(Si)	114krad(Si)	150krad(Si)
N° 1 (Ref)	---	3.632E-3	5.580E-4	3.488E-3	2.108E-3
N° 2 (ON)	---	7.599E-3	4.443E-3	4.292E-3	2.989E-3
N° 3 (ON)	---	5.200E-3	2.332E-3	2.733E-3	2.191E-3
N° 4 (ON)	---	4.622E-3	8.700E-4	3.332E-3	1.666E-3
N° 5 (ON)	---	4.821E-3	3.642E-3	2.229E-3	1.555E-3
N° 6 (ON)	---	4.652E-3	2.269E-3	2.080E-3	4.000E-4
N° 7 (OFF)	---	2.264E-3	-2.102E-3	-2.392E-3	-3.273E-3
N° 8 (OFF)	---	-2.830E-4	-3.665E-3	-3.722E-3	-5.308E-3
N° 9 (OFF)	---	4.677E-3	-1.734E-3	-1.239E-3	-2.786E-3
N° 10 (OFF)	---	8.020E-4	-1.857E-3	-2.501E-3	-2.641E-3
N° 11 (OFF)	---	1.184E-3	-3.040E-3	-1.670E-4	-3.726E-3
Average (ON)	---	5.379E-3	2.711E-3	2.933E-3	1.760E-3
s (ON)	---	1.262E-3	1.378E-3	9.041E-4	9.482E-4
Average+3s (ON)	---	9.166E-3	6.845E-3	5.645E-3	4.605E-3
Average-3s (ON)	---	1.592E-3	-1.423E-3	2.210E-4	-1.085E-3
Average (OFF)	---	1.729E-3	-2.480E-3	-2.004E-3	-3.547E-3
s (OFF)	---	1.883E-3	8.375E-4	1.352E-3	1.073E-3
Average+3s (OFF)	---	7.378E-3	3.278E-5	2.051E-3	-3.268E-4
Average-3s (OFF)	---	-3.920E-3	-4.992E-3	-6.059E-3	-6.767E-3

24. Vol_D3

Ta = 25°C; AVcc = DVcc = +5V; Vref tied to Voffset through 50 ohms; Iol= 10µA

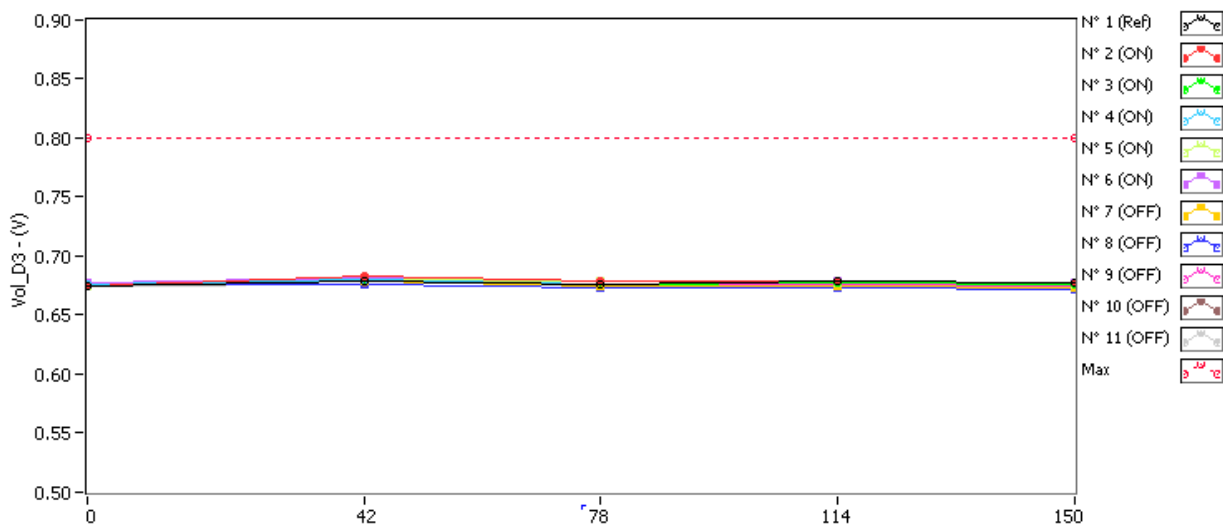

Vol_D3 . (V) Max = 0.8

	0krad(Si)	42krad(Si)	78krad(Si)	114krad(Si)	150krad(Si)
N° 1 (Ref)	0.675	0.679	0.676	0.679	0.677
N° 2 (ON)	0.675	0.683	0.679	0.679	0.678
N° 3 (ON)	0.674	0.679	0.676	0.677	0.676
N° 4 (ON)	0.675	0.680	0.676	0.679	0.676
N° 5 (ON)	0.675	0.680	0.679	0.677	0.677
N° 6 (ON)	0.677	0.682	0.679	0.679	0.677
N° 7 (OFF)	0.676	0.678	0.674	0.674	0.673
N° 8 (OFF)	0.676	0.676	0.673	0.673	0.672
N° 9 (OFF)	0.677	0.680	0.675	0.675	0.674
N° 10 (OFF)	0.675	0.676	0.673	0.673	0.672
N° 11 (OFF)	0.675	0.677	0.673	0.675	0.672

Delta [Vol_D3]

	0krad(Si)	42krad(Si)	78krad(Si)	114krad(Si)	150krad(Si)
N° 1 (Ref)	---	3.702E-3	5.310E-4	3.529E-3	2.146E-3
N° 2 (ON)	---	7.578E-3	4.400E-3	4.013E-3	3.109E-3
N° 3 (ON)	---	5.195E-3	2.277E-3	2.720E-3	2.089E-3
N° 4 (ON)	---	4.640E-3	8.590E-4	3.343E-3	5.410E-4
N° 5 (ON)	---	4.766E-3	3.532E-3	2.134E-3	1.572E-3
N° 6 (ON)	---	4.646E-3	2.217E-3	1.965E-3	2.190E-4
N° 7 (OFF)	---	2.138E-3	-1.936E-3	-2.326E-3	-2.977E-3
N° 8 (OFF)	---	-3.510E-4	-3.677E-3	-3.311E-3	-4.967E-3
N° 9 (OFF)	---	3.287E-3	-1.628E-3	-1.169E-3	-2.596E-3
N° 10 (OFF)	---	7.580E-4	-2.194E-3	-2.824E-3	-3.005E-3
N° 11 (OFF)	---	1.298E-3	-2.682E-3	4.800E-5	-3.347E-3
Average (ON)	---	5.365E-3	2.657E-3	2.835E-3	1.506E-3
s (ON)	---	1.258E-3	1.358E-3	8.525E-4	1.173E-3
Average+3s (ON)	---	9.138E-3	6.730E-3	5.393E-3	5.024E-3
Average-3s (ON)	---	1.592E-3	-1.416E-3	2.774E-4	-2.012E-3
Average (OFF)	---	1.426E-3	-2.423E-3	-1.916E-3	-3.378E-3
s (OFF)	---	1.378E-3	8.002E-4	1.356E-3	9.270E-4
Average+3s (OFF)	---	5.559E-3	-2.282E-5	2.151E-3	-5.974E-4
Average-3s (OFF)	---	-2.707E-3	-4.824E-3	-5.984E-3	-6.159E-3

25. Vol_D4

Ta = 25°C; AVcc = DVcc = +5V; Vref tied to Voffset through 50 ohms; Iol= 10µA

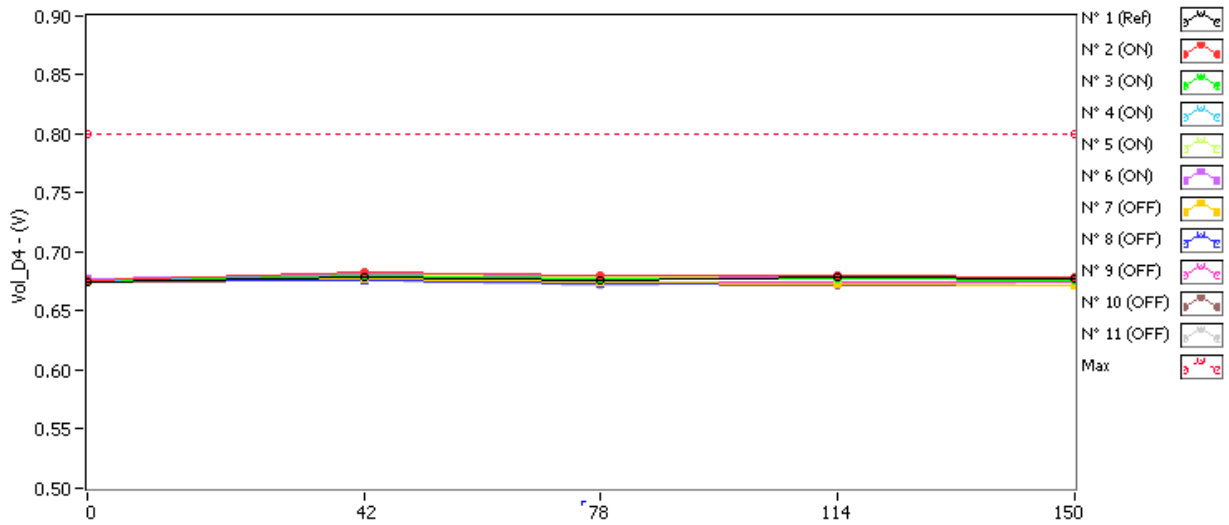

Vol_D4 . (V) Max = 0.8

	0krad(Si)	42krad(Si)	78krad(Si)	114krad(Si)	150krad(Si)
N° 1 (Ref)	0.675	0.679	0.676	0.679	0.677
N° 2 (ON)	0.676	0.683	0.680	0.680	0.679
N° 3 (ON)	0.675	0.680	0.677	0.677	0.676
N° 4 (ON)	0.676	0.680	0.676	0.679	0.677
N° 5 (ON)	0.675	0.680	0.679	0.677	0.677
N° 6 (ON)	0.677	0.682	0.679	0.679	0.677
N° 7 (OFF)	0.676	0.678	0.674	0.674	0.673
N° 8 (OFF)	0.677	0.676	0.673	0.673	0.671
N° 9 (OFF)	0.677	0.679	0.675	0.675	0.674
N° 10 (OFF)	0.675	0.676	0.673	0.672	0.672
N° 11 (OFF)	0.675	0.677	0.672	0.675	0.672

Delta [Vol_D4]

	0krad(Si)	42krad(Si)	78krad(Si)	114krad(Si)	150krad(Si)
N° 1 (Ref)	---	3.727E-3	4.300E-4	3.512E-3	2.145E-3
N° 2 (ON)	---	7.579E-3	4.281E-3	3.876E-3	3.152E-3
N° 3 (ON)	---	5.135E-3	2.162E-3	2.561E-3	1.655E-3
N° 4 (ON)	---	4.612E-3	7.980E-4	3.230E-3	1.690E-3
N° 5 (ON)	---	4.741E-3	3.455E-3	2.102E-3	1.594E-3
N° 6 (ON)	---	4.651E-3	2.261E-3	1.930E-3	2.190E-4
N° 7 (OFF)	---	1.719E-3	-2.134E-3	-2.556E-3	-3.744E-3
N° 8 (OFF)	---	-3.800E-4	-3.726E-3	-3.565E-3	-5.287E-3
N° 9 (OFF)	---	2.925E-3	-1.464E-3	-1.302E-3	-2.555E-3
N° 10 (OFF)	---	7.170E-4	-2.177E-3	-3.141E-3	-3.033E-3
N° 11 (OFF)	---	1.160E-3	-2.988E-3	-3.170E-4	-3.698E-3
Average (ON)	---	5.344E-3	2.591E-3	2.740E-3	1.662E-3
s (ON)	---	1.267E-3	1.333E-3	8.102E-4	1.038E-3
Average+3s (ON)	---	9.144E-3	6.591E-3	5.170E-3	4.775E-3
Average-3s (ON)	---	1.543E-3	-1.408E-3	3.092E-4	-1.451E-3
Average (OFF)	---	1.228E-3	-2.498E-3	-2.176E-3	-3.663E-3
s (OFF)	---	1.222E-3	8.736E-4	1.344E-3	1.033E-3
Average+3s (OFF)	---	4.894E-3	1.230E-4	1.856E-3	-5.639E-4
Average-3s (OFF)	---	-2.438E-3	-5.119E-3	-6.208E-3	-6.763E-3

26. Vol_D5

Ta = 25°C; AVcc = DVcc = +5V; Vref tied to Voffset through 50 ohms; Iol= 10µA

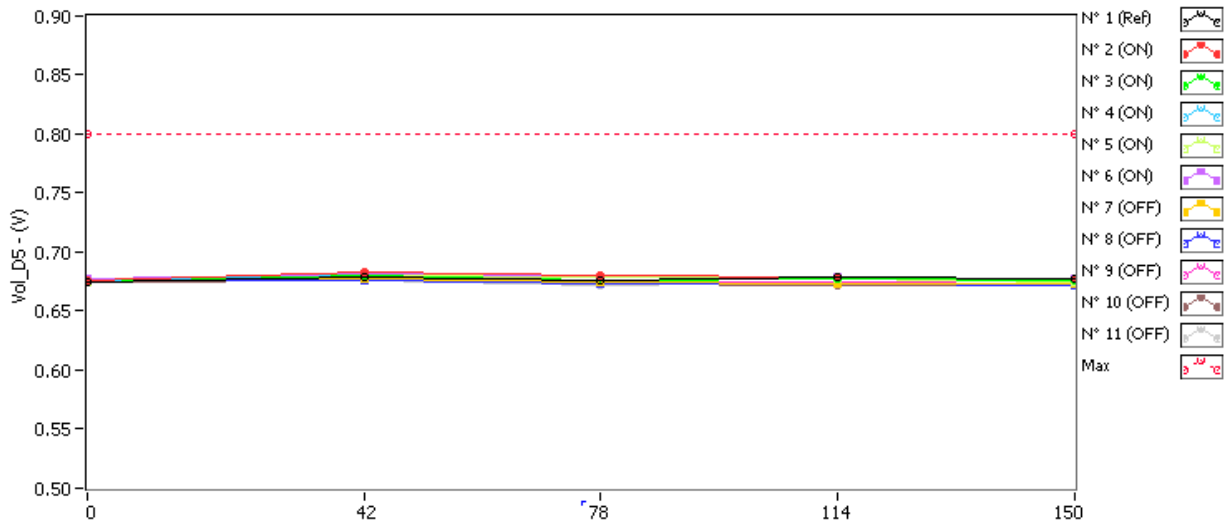

Vol_D5 . (V) Max = 0.8

	0krad(Si)	42krad(Si)	78krad(Si)	114krad(Si)	150krad(Si)
N° 1 (Ref)	0.675	0.679	0.676	0.679	0.677
N° 2 (ON)	0.675	0.683	0.680	0.679	0.677
N° 3 (ON)	0.675	0.680	0.677	0.677	0.677
N° 4 (ON)	0.676	0.680	0.676	0.679	0.676
N° 5 (ON)	0.675	0.680	0.678	0.677	0.675
N° 6 (ON)	0.677	0.682	0.679	0.679	0.677
N° 7 (OFF)	0.676	0.678	0.674	0.674	0.673
N° 8 (OFF)	0.677	0.676	0.673	0.673	0.671
N° 9 (OFF)	0.676	0.679	0.675	0.675	0.674
N° 10 (OFF)	0.675	0.676	0.673	0.672	0.672
N° 11 (OFF)	0.675	0.676	0.672	0.675	0.672

Delta [Vol_D5]

	0krad(Si)	42krad(Si)	78krad(Si)	114krad(Si)	150krad(Si)
N° 1 (Ref)	---	3.670E-3	4.330E-4	3.448E-3	2.165E-3
N° 2 (ON)	---	7.532E-3	4.212E-3	3.903E-3	1.960E-3
N° 3 (ON)	---	5.111E-3	2.079E-3	2.817E-3	1.998E-3
N° 4 (ON)	---	4.630E-3	8.250E-4	3.255E-3	5.280E-4
N° 5 (ON)	---	5.035E-3	3.680E-3	2.385E-3	4.320E-4
N° 6 (ON)	---	4.676E-3	2.194E-3	1.918E-3	1.620E-4
N° 7 (OFF)	---	1.635E-3	-2.088E-3	-2.503E-3	-3.468E-3
N° 8 (OFF)	---	-2.600E-4	-3.610E-3	-3.431E-3	-5.192E-3
N° 9 (OFF)	---	2.723E-3	-1.478E-3	-1.334E-3	-2.655E-3
N° 10 (OFF)	---	6.920E-4	-2.178E-3	-3.083E-3	-3.023E-3
N° 11 (OFF)	---	1.152E-3	-2.948E-3	-3.050E-4	-3.568E-3
Average (ON)	---	5.397E-3	2.598E-3	2.856E-3	1.016E-3
s (ON)	---	1.212E-3	1.356E-3	7.679E-4	8.894E-4
Average+3s (ON)	---	9.034E-3	6.665E-3	5.159E-3	3.684E-3
Average-3s (ON)	---	1.760E-3	-1.469E-3	5.519E-4	-1.652E-3
Average (OFF)	---	1.188E-3	-2.460E-3	-2.131E-3	-3.581E-3
s (OFF)	---	1.107E-3	8.281E-4	1.295E-3	9.717E-4
Average+3s (OFF)	---	4.509E-3	2.384E-5	1.753E-3	-6.660E-4
Average-3s (OFF)	---	-2.132E-3	-4.945E-3	-6.015E-3	-6.496E-3

27. Vol_D6

Ta = 25°C; AVcc = DVcc = +5V; Vref tied to Voffset through 50 ohms; Iol= 10µA

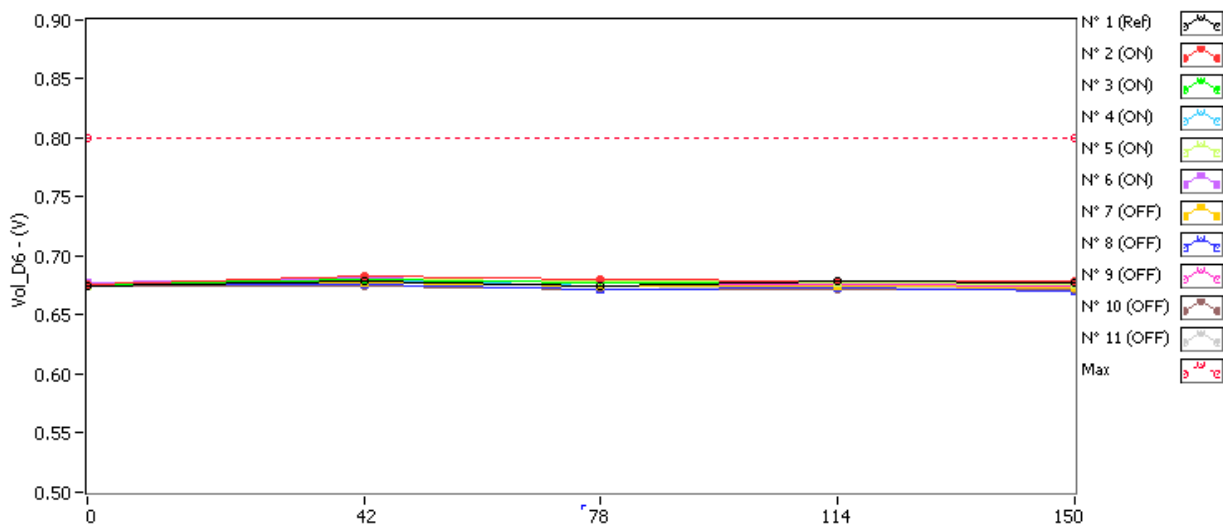

Vol_D6 . (V) Max = 0.8

	0krad(Si)	42krad(Si)	78krad(Si)	114krad(Si)	150krad(Si)
N° 1 (Ref)	0.675	0.679	0.675	0.679	0.677
N° 2 (ON)	0.676	0.683	0.680	0.679	0.679
N° 3 (ON)	0.676	0.681	0.677	0.679	0.678
N° 4 (ON)	0.676	0.680	0.675	0.679	0.677
N° 5 (ON)	0.675	0.680	0.678	0.677	0.676
N° 6 (ON)	0.677	0.682	0.678	0.678	0.676
N° 7 (OFF)	0.676	0.678	0.674	0.674	0.673
N° 8 (OFF)	0.676	0.676	0.672	0.673	0.671
N° 9 (OFF)	0.677	0.679	0.675	0.676	0.674
N° 10 (OFF)	0.675	0.675	0.672	0.672	0.672
N° 11 (OFF)	0.675	0.676	0.672	0.674	0.672

Delta [Vol_D6]

	0krad(Si)	42krad(Si)	78krad(Si)	114krad(Si)	150krad(Si)
N° 1 (Ref)	---	3.645E-3	-2.200E-5	3.650E-3	2.325E-3
N° 2 (ON)	---	7.453E-3	4.254E-3	3.445E-3	2.760E-3
N° 3 (ON)	---	4.707E-3	8.850E-4	3.176E-3	2.315E-3
N° 4 (ON)	---	4.624E-3	-6.950E-4	3.455E-3	1.241E-3
N° 5 (ON)	---	5.079E-3	3.632E-3	2.450E-3	1.906E-3
N° 6 (ON)	---	4.594E-3	8.880E-4	8.820E-4	-6.380E-4
N° 7 (OFF)	---	2.163E-3	-1.561E-3	-1.839E-3	-2.684E-3
N° 8 (OFF)	---	-1.050E-4	-3.385E-3	-3.098E-3	-4.825E-3
N° 9 (OFF)	---	2.608E-3	-1.815E-3	-9.690E-4	-2.607E-3
N° 10 (OFF)	---	7.060E-4	-2.302E-3	-2.924E-3	-3.070E-3
N° 11 (OFF)	---	1.227E-3	-2.980E-3	-9.180E-4	-3.499E-3
Average (ON)	---	5.291E-3	1.793E-3	2.682E-3	1.517E-3
s (ON)	---	1.224E-3	2.078E-3	1.086E-3	1.328E-3
Average+3s (ON)	---	8.963E-3	8.027E-3	5.940E-3	5.501E-3
Average-3s (ON)	---	1.620E-3	-4.441E-3	-5.764E-4	-2.467E-3
Average (OFF)	---	1.320E-3	-2.409E-3	-1.950E-3	-3.337E-3
s (OFF)	---	1.094E-3	7.684E-4	1.038E-3	9.043E-4
Average+3s (OFF)	---	4.601E-3	-1.033E-4	1.163E-3	-6.241E-4
Average-3s (OFF)	---	-1.962E-3	-4.714E-3	-5.062E-3	-6.050E-3

28. Vol_D7

Ta = 25°C; AVcc = DVcc = +5V; Vref tied to Voffset through 50 ohms; Iol= 10µA

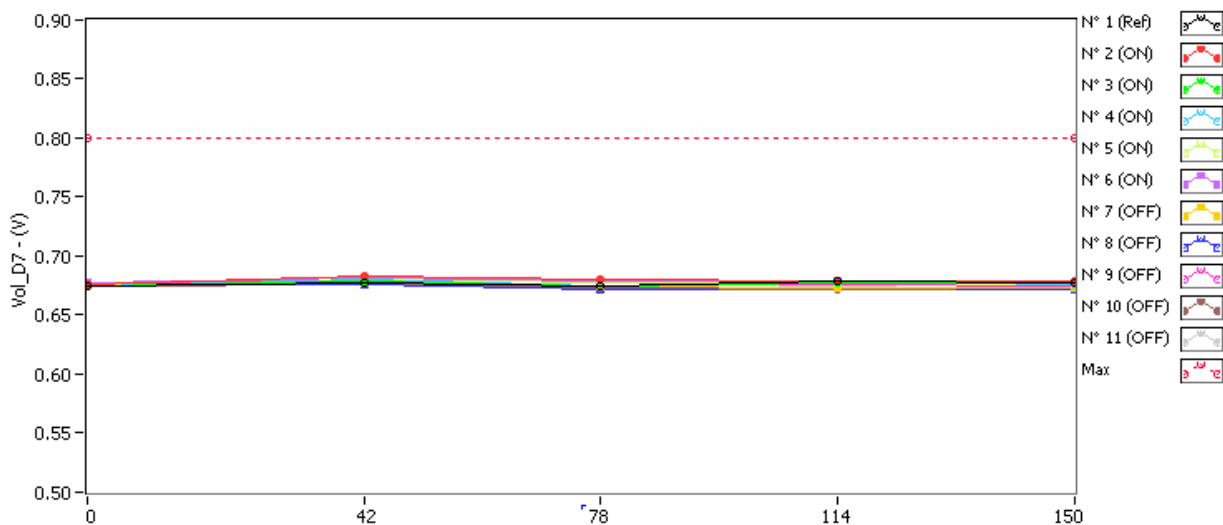

Vol_D7 . (V) Max = 0.8

	0krad(Si)	42krad(Si)	78krad(Si)	114krad(Si)	150krad(Si)
N° 1 (Ref)	0.675	0.678	0.675	0.678	0.677
N° 2 (ON)	0.675	0.683	0.680	0.679	0.678
N° 3 (ON)	0.675	0.679	0.675	0.678	0.677
N° 4 (ON)	0.675	0.680	0.674	0.679	0.675
N° 5 (ON)	0.675	0.680	0.677	0.678	0.676
N° 6 (ON)	0.677	0.682	0.679	0.679	0.678
N° 7 (OFF)	0.676	0.678	0.674	0.674	0.673
N° 8 (OFF)	0.676	0.676	0.672	0.673	0.671
N° 9 (OFF)	0.677	0.679	0.675	0.676	0.674
N° 10 (OFF)	0.675	0.676	0.673	0.672	0.672
N° 11 (OFF)	0.675	0.676	0.672	0.674	0.671

Delta [Vol_D7]

	0krad(Si)	42krad(Si)	78krad(Si)	114krad(Si)	150krad(Si)
N° 1 (Ref)	---	3.041E-3	-6.300E-5	3.615E-3	2.486E-3
N° 2 (ON)	---	7.707E-3	4.466E-3	3.728E-3	3.023E-3
N° 3 (ON)	---	4.272E-3	7.910E-4	3.247E-3	2.477E-3
N° 4 (ON)	---	4.604E-3	-7.190E-4	3.549E-3	3.070E-4
N° 5 (ON)	---	4.803E-3	2.447E-3	2.981E-3	8.080E-4
N° 6 (ON)	---	4.353E-3	1.942E-3	1.891E-3	5.640E-4
N° 7 (OFF)	---	1.997E-3	-1.508E-3	-1.854E-3	-2.748E-3
N° 8 (OFF)	---	4.930E-4	-3.211E-3	-2.549E-3	-4.225E-3
N° 9 (OFF)	---	2.483E-3	-1.804E-3	-1.048E-3	-2.606E-3
N° 10 (OFF)	---	6.760E-4	-2.498E-3	-3.003E-3	-3.185E-3
N° 11 (OFF)	---	1.012E-3	-2.845E-3	-9.130E-4	-3.595E-3
Average (ON)	---	5.148E-3	1.785E-3	3.079E-3	1.436E-3
s (ON)	---	1.446E-3	1.931E-3	7.231E-4	1.228E-3
Average+3s (ON)	---	9.486E-3	7.577E-3	5.248E-3	5.120E-3
Average-3s (ON)	---	8.100E-4	-4.006E-3	9.100E-4	-2.248E-3
Average (OFF)	---	1.332E-3	-2.373E-3	-1.873E-3	-3.272E-3
s (OFF)	---	8.666E-4	7.093E-4	9.133E-4	6.592E-4
Average+3s (OFF)	---	3.932E-3	-2.452E-4	8.665E-4	-1.294E-3
Average-3s (OFF)	---	-1.267E-3	-4.501E-3	-4.613E-3	-5.249E-3

29. Vol_D8

Ta = 25°C; AVcc = DVcc = +5V; Vref tied to Voffset through 50 ohms; Iol= 10µA

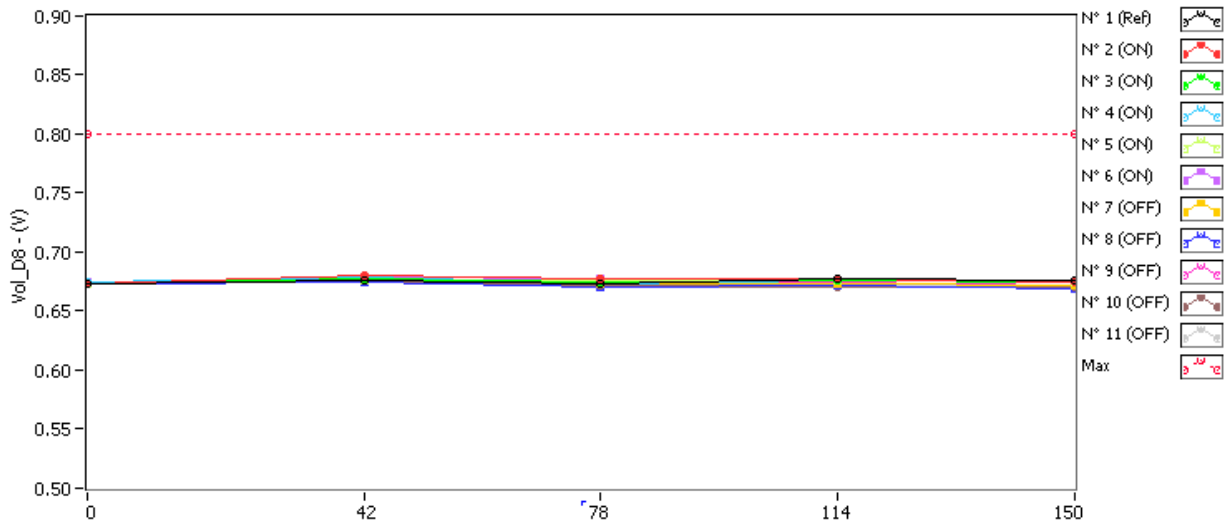

Vol_D8 . (V) Max = 0.8

	0krad(Si)	42krad(Si)	78krad(Si)	114krad(Si)	150krad(Si)
N° 1 (Ref)	0.673	0.676	0.673	0.677	0.676
N° 2 (ON)	0.673	0.681	0.678	0.677	0.675
N° 3 (ON)	0.673	0.678	0.675	0.676	0.675
N° 4 (ON)	0.674	0.679	0.674	0.677	0.675
N° 5 (ON)	0.673	0.676	0.676	0.676	0.675
N° 6 (ON)	0.675	0.679	0.677	0.677	0.675
N° 7 (OFF)	0.675	0.677	0.673	0.673	0.672
N° 8 (OFF)	0.674	0.674	0.671	0.671	0.670
N° 9 (OFF)	0.675	0.677	0.673	0.674	0.672
N° 10 (OFF)	0.673	0.674	0.671	0.671	0.671
N° 11 (OFF)	0.673	0.674	0.670	0.672	0.670

Delta [Vol_D8]

	0krad(Si)	42krad(Si)	78krad(Si)	114krad(Si)	150krad(Si)
N° 1 (Ref)	---	2.997E-3	1.150E-4	3.840E-3	2.855E-3
N° 2 (ON)	---	7.888E-3	4.708E-3	4.319E-3	2.395E-3
N° 3 (ON)	---	4.118E-3	1.858E-3	2.604E-3	1.857E-3
N° 4 (ON)	---	4.677E-3	-5.760E-4	2.088E-3	3.940E-4
N° 5 (ON)	---	2.909E-3	3.374E-3	2.746E-3	1.630E-3
N° 6 (ON)	---	4.422E-3	2.142E-3	1.744E-3	-2.120E-4
N° 7 (OFF)	---	1.731E-3	-1.594E-3	-1.860E-3	-2.836E-3
N° 8 (OFF)	---	6.110E-4	-3.044E-3	-2.486E-3	-4.172E-3
N° 9 (OFF)	---	2.378E-3	-1.649E-3	-9.400E-4	-2.568E-3
N° 10 (OFF)	---	8.080E-4	-2.077E-3	-2.666E-3	-2.744E-3
N° 11 (OFF)	---	9.480E-4	-2.694E-3	-8.650E-4	-3.355E-3
Average (ON)	---	4.803E-3	2.301E-3	2.700E-3	1.213E-3
s (ON)	---	1.853E-3	1.965E-3	9.901E-4	1.082E-3
Average+3s (ON)	---	1.036E-2	8.196E-3	5.670E-3	4.460E-3
Average-3s (ON)	---	-7.563E-4	-3.594E-3	-2.700E-4	-2.035E-3
Average (OFF)	---	1.295E-3	-2.212E-3	-1.763E-3	-3.135E-3
s (OFF)	---	7.397E-4	6.406E-4	8.413E-4	6.495E-4
Average+3s (OFF)	---	3.514E-3	-2.897E-4	7.606E-4	-1.186E-3
Average-3s (OFF)	---	-9.238E-4	-4.134E-3	-4.287E-3	-5.084E-3

30. Vol_D9

Ta = 25°C; AVcc = DVcc = +5V; Vref tied to Voffset through 50 ohms; Iol= 10µA

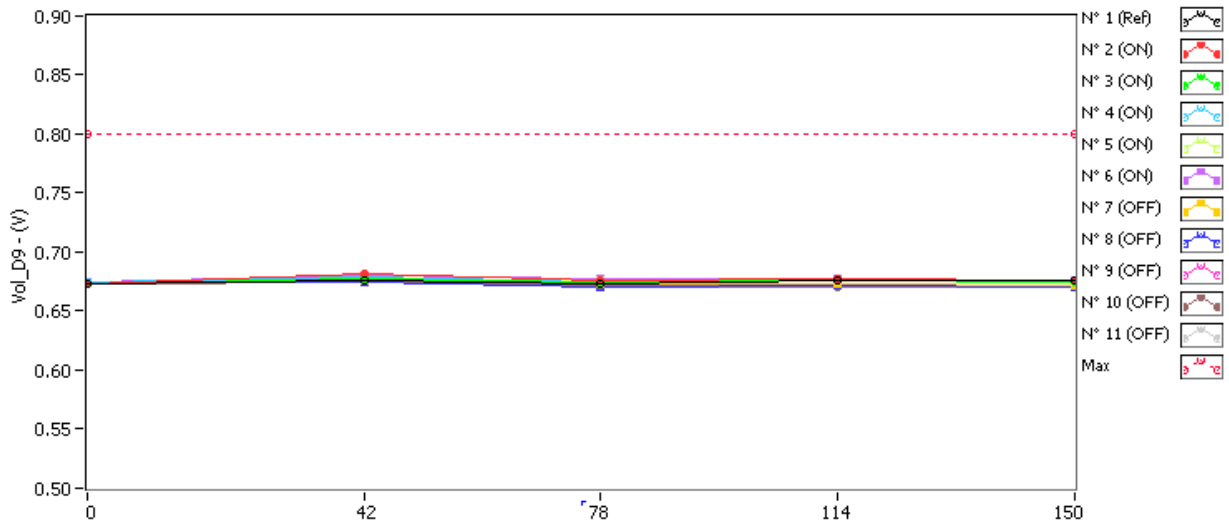

Vol_D9 . (V) Max = 0.8

	0krad(Si)	42krad(Si)	78krad(Si)	114krad(Si)	150krad(Si)
N° 1 (Ref)	0.673	0.676	0.673	0.677	0.676
N° 2 (ON)	0.673	0.681	0.676	0.678	0.676
N° 3 (ON)	0.674	0.678	0.674	0.676	0.675
N° 4 (ON)	0.674	0.679	0.675	0.678	0.675
N° 5 (ON)	0.673	0.678	0.677	0.676	0.674
N° 6 (ON)	0.675	0.680	0.677	0.678	0.676
N° 7 (OFF)	0.675	0.676	0.673	0.673	0.672
N° 8 (OFF)	0.674	0.675	0.671	0.672	0.670
N° 9 (OFF)	0.675	0.677	0.673	0.674	0.672
N° 10 (OFF)	0.674	0.674	0.672	0.671	0.671
N° 11 (OFF)	0.674	0.675	0.671	0.673	0.671

Delta [Vol_D9]

	0krad(Si)	42krad(Si)	78krad(Si)	114krad(Si)	150krad(Si)
N° 1 (Ref)	---	2.894E-3	-1.300E-5	3.768E-3	2.893E-3
N° 2 (ON)	---	7.757E-3	3.041E-3	4.524E-3	2.880E-3
N° 3 (ON)	---	4.023E-3	3.820E-4	2.876E-3	1.615E-3
N° 4 (ON)	---	4.662E-3	8.480E-4	3.440E-3	8.120E-4
N° 5 (ON)	---	4.915E-3	3.623E-3	2.717E-3	1.143E-3
N° 6 (ON)	---	4.418E-3	2.112E-3	2.182E-3	4.710E-4
N° 7 (OFF)	---	1.670E-3	-1.607E-3	-1.889E-3	-2.831E-3
N° 8 (OFF)	---	6.890E-4	-3.145E-3	-2.409E-3	-4.100E-3
N° 9 (OFF)	---	2.225E-3	-1.853E-3	-1.036E-3	-2.676E-3
N° 10 (OFF)	---	5.990E-4	-2.043E-3	-2.875E-3	-2.895E-3
N° 11 (OFF)	---	7.740E-4	-2.790E-3	-9.440E-4	-3.247E-3
Average (ON)	---	5.155E-3	2.001E-3	3.148E-3	1.384E-3
s (ON)	---	1.491E-3	1.385E-3	8.904E-4	9.368E-4
Average+3s (ON)	---	9.629E-3	6.157E-3	5.819E-3	4.195E-3
Average-3s (ON)	---	6.812E-4	-2.154E-3	4.765E-4	-1.426E-3
Average (OFF)	---	1.191E-3	-2.288E-3	-1.831E-3	-3.150E-3
s (OFF)	---	7.202E-4	6.518E-4	8.435E-4	5.708E-4
Average+3s (OFF)	---	3.352E-3	-3.321E-4	7.000E-4	-1.437E-3
Average-3s (OFF)	---	-9.693E-4	-4.243E-3	-4.361E-3	-4.862E-3

31. Vol_D10

Ta = 25°C; AVcc = DVcc = +5V; Vref tied to Voffset through 50 ohms; Iol= 10µA

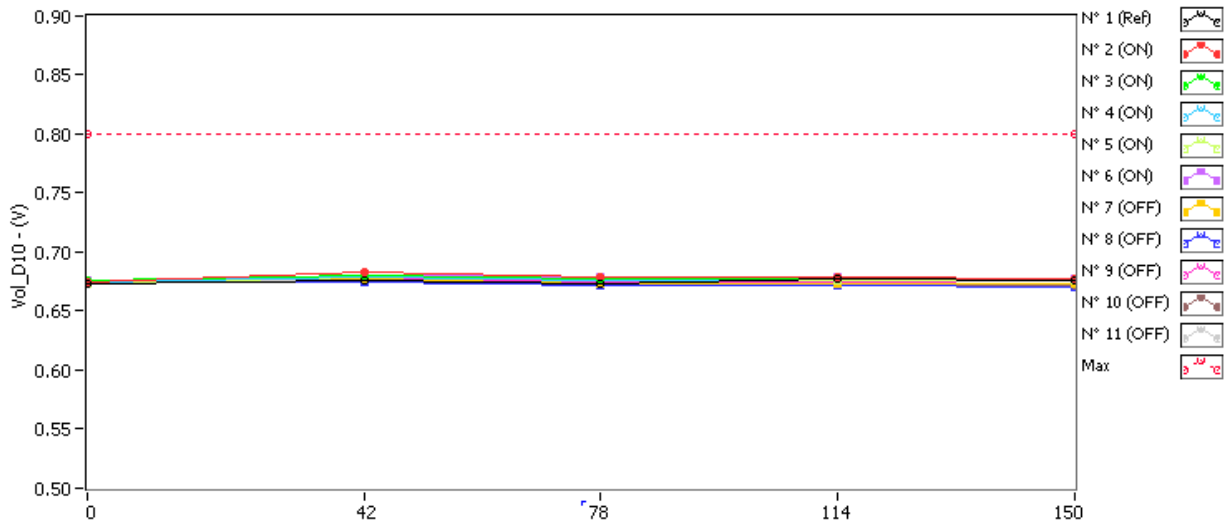

Vol_D10 . (V) Max = 0.8

	0krad(Si)	42krad(Si)	78krad(Si)	114krad(Si)	150krad(Si)
N° 1 (Ref)	0.674	0.677	0.674	0.678	0.677
N° 2 (ON)	0.675	0.682	0.679	0.679	0.678
N° 3 (ON)	0.676	0.680	0.677	0.678	0.677
N° 4 (ON)	0.675	0.679	0.676	0.678	0.676
N° 5 (ON)	0.674	0.679	0.677	0.676	0.676
N° 6 (ON)	0.676	0.681	0.679	0.679	0.677
N° 7 (OFF)	0.676	0.677	0.674	0.674	0.673
N° 8 (OFF)	0.674	0.675	0.672	0.672	0.671
N° 9 (OFF)	0.676	0.678	0.674	0.675	0.673
N° 10 (OFF)	0.674	0.675	0.672	0.672	0.671
N° 11 (OFF)	0.675	0.676	0.672	0.674	0.672

Delta [Vol_D10]

	0krad(Si)	42krad(Si)	78krad(Si)	114krad(Si)	150krad(Si)
N° 1 (Ref)	---	2.833E-3	-5.400E-5	3.756E-3	2.866E-3
N° 2 (ON)	---	7.698E-3	4.446E-3	4.193E-3	3.410E-3
N° 3 (ON)	---	4.013E-3	1.665E-3	2.046E-3	1.050E-3
N° 4 (ON)	---	4.619E-3	8.370E-4	3.375E-3	1.557E-3
N° 5 (ON)	---	4.888E-3	3.492E-3	2.575E-3	1.837E-3
N° 6 (ON)	---	4.401E-3	2.092E-3	2.168E-3	4.450E-4
N° 7 (OFF)	---	1.631E-3	-1.718E-3	-1.697E-3	-2.768E-3
N° 8 (OFF)	---	7.210E-4	-2.711E-3	-2.132E-3	-3.892E-3
N° 9 (OFF)	---	2.098E-3	-1.739E-3	-1.039E-3	-2.754E-3
N° 10 (OFF)	---	5.740E-4	-2.169E-3	-2.540E-3	-2.826E-3
N° 11 (OFF)	---	7.960E-4	-2.621E-3	-9.740E-4	-3.331E-3
Average (ON)	---	5.124E-3	2.506E-3	2.871E-3	1.660E-3
s (ON)	---	1.474E-3	1.449E-3	9.033E-4	1.113E-3
Average+3s (ON)	---	9.546E-3	6.854E-3	5.581E-3	4.998E-3
Average-3s (ON)	---	7.012E-4	-1.841E-3	1.614E-4	-1.678E-3
Average (OFF)	---	1.164E-3	-2.192E-3	-1.676E-3	-3.114E-3
s (OFF)	---	6.652E-4	4.701E-4	6.807E-4	4.961E-4
Average+3s (OFF)	---	3.160E-3	-7.814E-4	3.657E-4	-1.626E-3
Average-3s (OFF)	---	-8.317E-4	-3.602E-3	-3.719E-3	-4.603E-3

32. Vol_D11

Ta = 25°C; AVcc = DVcc = +5V; Vref tied to Voffset through 50 ohms; Iol= 10µA

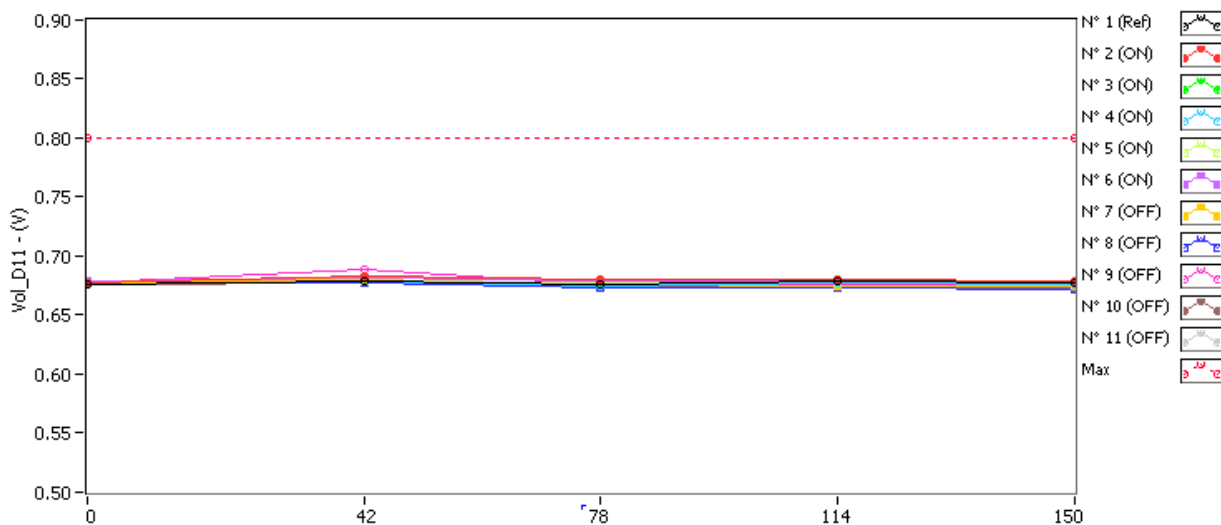

Vol_D11 . (V)

Max = 0.8

	0krad(Si)	42krad(Si)	78krad(Si)	114krad(Si)	150krad(Si)
N° 1 (Ref)	0.675	0.679	0.677	0.679	0.678
N° 2 (ON)	0.677	0.683	0.680	0.680	0.679
N° 3 (ON)	0.675	0.679	0.676	0.678	0.679
N° 4 (ON)	0.676	0.679	0.675	0.678	0.676
N° 5 (ON)	0.676	0.679	0.678	0.677	0.676
N° 6 (ON)	0.678	0.681	0.679	0.679	0.677
N° 7 (OFF)	0.677	0.680	0.676	0.675	0.674
N° 8 (OFF)	0.678	0.677	0.673	0.674	0.672
N° 9 (OFF)	0.678	0.689	0.676	0.677	0.675
N° 10 (OFF)	0.677	0.677	0.674	0.674	0.674
N° 11 (OFF)	0.676	0.678	0.674	0.677	0.673

Delta [Vol_D11]

	0krad(Si)	42krad(Si)	78krad(Si)	114krad(Si)	150krad(Si)
N° 1 (Ref)	---	4.013E-3	1.262E-3	3.522E-3	2.431E-3
N° 2 (ON)	---	5.559E-3	2.643E-3	2.439E-3	1.452E-3
N° 3 (ON)	---	3.292E-3	3.700E-4	2.819E-3	3.685E-3
N° 4 (ON)	---	2.676E-3	-1.067E-3	1.935E-3	2.210E-4
N° 5 (ON)	---	3.132E-3	2.486E-3	1.290E-3	2.180E-4
N° 6 (ON)	---	2.815E-3	3.120E-4	7.660E-4	-8.770E-4
N° 7 (OFF)	---	2.768E-3	-1.790E-3	-2.109E-3	-2.986E-3
N° 8 (OFF)	---	-6.440E-4	-4.044E-3	-3.892E-3	-5.453E-3
N° 9 (OFF)	---	1.111E-2	-2.074E-3	-1.450E-3	-2.874E-3
N° 10 (OFF)	---	4.030E-4	-2.285E-3	-3.103E-3	-2.785E-3
N° 11 (OFF)	---	1.606E-3	-2.580E-3	6.200E-4	-3.099E-3
Average (ON)	---	3.495E-3	9.488E-4	1.850E-3	9.398E-4
s (ON)	---	1.180E-3	1.584E-3	8.339E-4	1.742E-3
Average+3s (ON)	---	7.034E-3	5.701E-3	4.352E-3	6.166E-3
Average-3s (ON)	---	-4.413E-5	-3.803E-3	-6.520E-4	-4.286E-3
Average (OFF)	---	3.049E-3	-2.555E-3	-1.987E-3	-3.439E-3
s (OFF)	---	4.685E-3	8.814E-4	1.730E-3	1.132E-3
Average+3s (OFF)	---	1.710E-2	8.950E-5	3.204E-3	-4.398E-5
Average-3s (OFF)	---	-1.101E-2	-5.199E-3	-7.177E-3	-6.835E-3

33. ICCD

Ta = 25°C; AVcc = DVcc = +5V; Vref tied to Voffset through 50 ohms

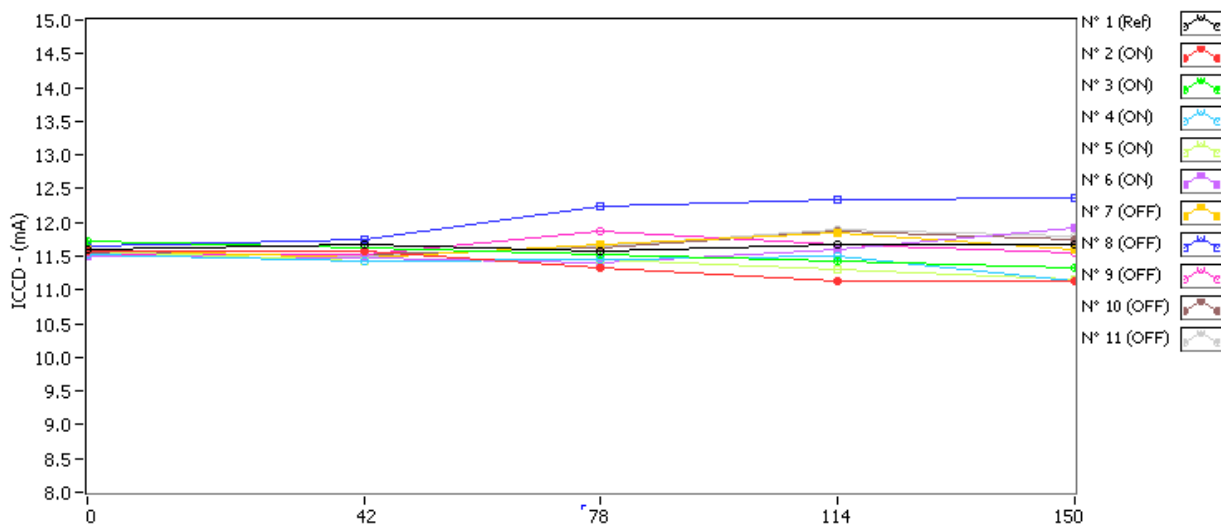

ICCD . (mA)

	0krad(Si)	42krad(Si)	78krad(Si)	114krad(Si)	150krad(Si)
N° 1 (Ref)	11.59	11.67	11.58	11.66	11.67
N° 2 (ON)	11.58	11.58	11.32	11.12	11.14
N° 3 (ON)	11.71	11.61	11.52	11.44	11.33
N° 4 (ON)	11.52	11.43	11.44	11.49	11.14
N° 5 (ON)	11.56	11.43	11.44	11.30	11.15
N° 6 (ON)	11.49	11.48	11.41	11.61	11.92
N° 7 (OFF)	11.60	11.47	11.68	11.84	11.59
N° 8 (OFF)	11.66	11.75	12.24	12.33	12.36
N° 9 (OFF)	11.53	11.53	11.86	11.67	11.55
N° 10 (OFF)	11.55	11.53	11.62	11.86	11.74
N° 11 (OFF)	11.58	11.49	11.65	11.89	11.79

Delta [ICCD]

	0krad(Si)	42krad(Si)	78krad(Si)	114krad(Si)	150krad(Si)
N° 1 (Ref)	---	7.108E-2	-1.549E-2	6.590E-2	7.319E-2
N° 2 (ON)	---	1.380E-3	-2.551E-1	-4.520E-1	-4.414E-1
N° 3 (ON)	---	-1.018E-1	-1.974E-1	-2.754E-1	-3.875E-1
N° 4 (ON)	---	-8.335E-2	-7.368E-2	-2.681E-2	-3.744E-1
N° 5 (ON)	---	-1.353E-1	-1.221E-1	-2.622E-1	-4.100E-1
N° 6 (ON)	---	-1.707E-2	-8.360E-2	1.153E-1	4.217E-1
N° 7 (OFF)	---	-1.243E-1	8.560E-2	2.446E-1	-7.060E-3
N° 8 (OFF)	---	8.989E-2	5.823E-1	6.693E-1	7.011E-1
N° 9 (OFF)	---	3.490E-3	3.330E-1	1.374E-1	2.195E-2
N° 10 (OFF)	---	-2.376E-2	6.706E-2	3.107E-1	1.828E-1
N° 11 (OFF)	---	-8.874E-2	6.395E-2	3.077E-1	2.117E-1
Average (ON)	---	-6.722E-2	-1.464E-1	-1.802E-1	-2.383E-1
s (ON)	---	5.768E-2	7.785E-2	2.239E-1	3.698E-1
Average+3s (ON)	---	1.058E-1	8.715E-2	4.915E-1	8.712E-1
Average-3s (ON)	---	-2.402E-1	-3.799E-1	-8.520E-1	-1.348E+0
Average (OFF)	---	-2.869E-2	2.264E-1	3.339E-1	2.221E-1
s (OFF)	---	8.348E-2	2.289E-1	2.002E-1	2.844E-1
Average+3s (OFF)	---	2.217E-1	9.132E-1	9.345E-1	1.075E+0
Average-3s (OFF)	---	-2.791E-1	-4.604E-1	-2.666E-1	-6.312E-1

34. ICCA

Ta = 25°C; AVcc = DVcc = +5V; Vref tied to Voffset through 50 ohms

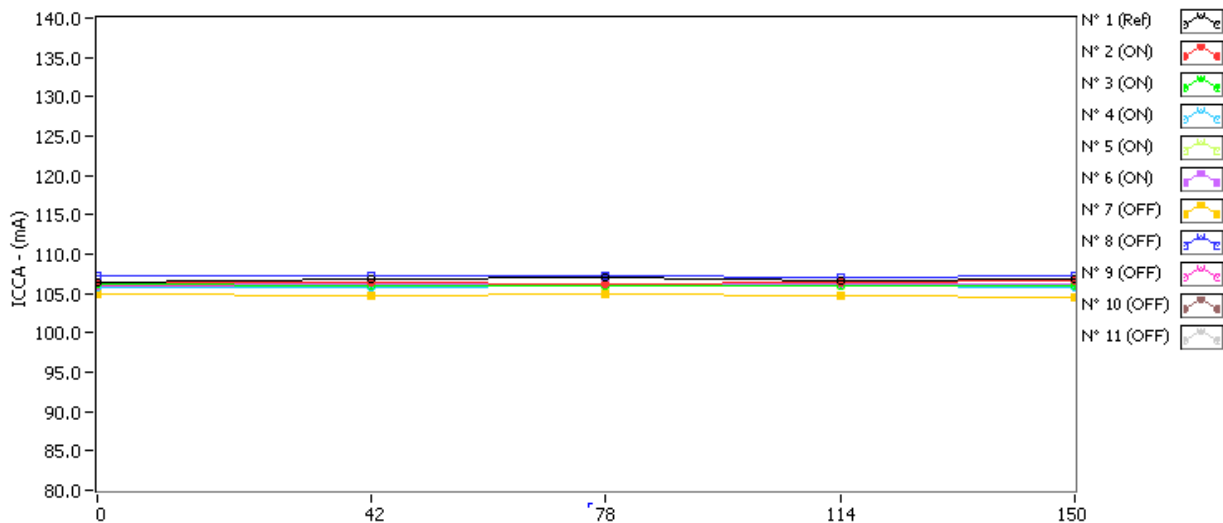

ICCA . (mA)

	0krad(Si)	42krad(Si)	78krad(Si)	114krad(Si)	150krad(Si)
N° 1 (Ref)	106.42	106.82	107.02	106.70	106.83
N° 2 (ON)	106.37	106.35	106.28	106.34	106.55
N° 3 (ON)	106.23	105.93	105.92	105.88	105.90
N° 4 (ON)	105.70	105.77	105.91	105.89	105.79
N° 5 (ON)	106.10	105.95	106.02	105.98	105.99
N° 6 (ON)	106.21	106.11	106.17	106.15	106.19
N° 7 (OFF)	104.88	104.70	104.93	104.68	104.54
N° 8 (OFF)	107.15	107.26	107.35	107.11	107.18
N° 9 (OFF)	105.95	105.91	106.01	105.90	105.78
N° 10 (OFF)	105.95	105.82	106.02	105.92	105.86
N° 11 (OFF)	106.00	106.03	106.20	106.08	106.02

Delta [ICCA]

	0krad(Si)	42krad(Si)	78krad(Si)	114krad(Si)	150krad(Si)
N° 1 (Ref)	---	4.030E-1	5.982E-1	2.756E-1	4.058E-1
N° 2 (ON)	---	-2.760E-2	-9.170E-2	-2.870E-2	1.764E-1
N° 3 (ON)	---	-2.970E-1	-3.094E-1	-3.426E-1	-3.281E-1
N° 4 (ON)	---	6.690E-2	2.037E-1	1.844E-1	9.200E-2
N° 5 (ON)	---	-1.473E-1	-8.280E-2	-1.178E-1	-1.077E-1
N° 6 (ON)	---	-1.020E-1	-4.010E-2	-6.120E-2	-2.890E-2
N° 7 (OFF)	---	-1.780E-1	5.270E-2	-1.987E-1	-3.425E-1
N° 8 (OFF)	---	1.165E-1	2.060E-1	-4.310E-2	3.280E-2
N° 9 (OFF)	---	-4.440E-2	5.250E-2	-5.320E-2	-1.739E-1
N° 10 (OFF)	---	-1.260E-1	7.380E-2	-2.760E-2	-8.820E-2
N° 11 (OFF)	---	2.430E-2	1.947E-1	7.690E-2	1.850E-2
Average (ON)	---	-1.014E-1	-6.406E-2	-7.318E-2	-3.926E-2
s (ON)	---	1.361E-1	1.827E-1	1.891E-1	1.949E-1
Average+3s (ON)	---	3.070E-1	4.842E-1	4.941E-1	5.455E-1
Average-3s (ON)	---	-5.098E-1	-6.123E-1	-6.405E-1	-6.240E-1
Average (OFF)	---	-4.152E-2	1.159E-1	-4.914E-2	-1.107E-1
s (OFF)	---	1.173E-1	7.764E-2	9.845E-2	1.545E-1
Average+3s (OFF)	---	3.105E-1	3.489E-1	2.462E-1	3.529E-1
Average-3s (OFF)	---	-3.935E-1	-1.170E-1	-3.445E-1	-5.742E-1

35. ICC_TOTAL

Ta = 25°C; AVcc = DVcc = +5V; Vref tied to Voffset through 50 ohms

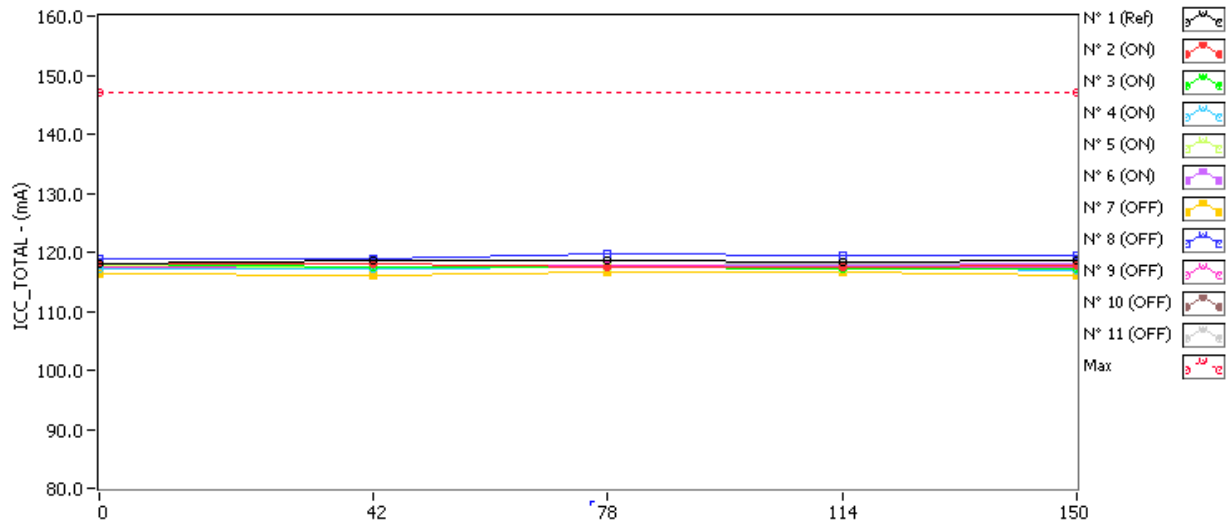

ICC_TOTAL . (mA)

Max = 147.0

	0krad(Si)	42krad(Si)	78krad(Si)	114krad(Si)	150krad(Si)
N° 1 (Ref)	118.02	118.49	118.60	118.36	118.49
N° 2 (ON)	117.95	117.92	117.60	117.47	117.69
N° 3 (ON)	117.94	117.54	117.43	117.32	117.22
N° 4 (ON)	117.22	117.20	117.35	117.37	116.93
N° 5 (ON)	117.66	117.38	117.46	117.28	117.15
N° 6 (ON)	117.71	117.59	117.58	117.76	118.10
N° 7 (OFF)	116.48	116.17	116.61	116.52	116.13
N° 8 (OFF)	118.81	119.01	119.59	119.43	119.54
N° 9 (OFF)	117.48	117.44	117.87	117.56	117.33
N° 10 (OFF)	117.50	117.35	117.64	117.79	117.60
N° 11 (OFF)	117.59	117.52	117.84	117.97	117.82

Delta [ICC_TOTAL]

	0krad(Si)	42krad(Si)	78krad(Si)	114krad(Si)	150krad(Si)
N° 1 (Ref)	---	4.740E-1	5.827E-1	3.414E-1	4.789E-1
N° 2 (ON)	---	-2.620E-2	-3.468E-1	-4.808E-1	-2.651E-1
N° 3 (ON)	---	-3.988E-1	-5.070E-1	-6.181E-1	-7.157E-1
N° 4 (ON)	---	-1.650E-2	1.301E-1	1.576E-1	-2.823E-1
N° 5 (ON)	---	-2.825E-1	-2.049E-1	-3.800E-1	-5.177E-1
N° 6 (ON)	---	-1.191E-1	-1.237E-1	5.410E-2	3.928E-1
N° 7 (OFF)	---	-3.024E-1	1.382E-1	4.580E-2	-3.496E-1
N° 8 (OFF)	---	2.064E-1	7.883E-1	6.261E-1	7.339E-1
N° 9 (OFF)	---	-4.090E-2	3.855E-1	8.420E-2	-1.519E-1
N° 10 (OFF)	---	-1.497E-1	1.409E-1	2.831E-1	9.470E-2
N° 11 (OFF)	---	-6.450E-2	2.587E-1	3.846E-1	2.303E-1
Average (ON)	---	-1.686E-1	-2.105E-1	-2.534E-1	-2.776E-1
s (ON)	---	1.672E-1	2.398E-1	3.407E-1	4.181E-1
Average+3s (ON)	---	3.330E-1	5.090E-1	7.686E-1	9.767E-1
Average-3s (ON)	---	-6.702E-1	-9.299E-1	-1.275E+0	-1.532E+0
Average (OFF)	---	-7.022E-2	3.423E-1	2.848E-1	1.115E-1
s (OFF)	---	1.855E-1	2.693E-1	2.365E-1	4.135E-1
Average+3s (OFF)	---	4.863E-1	1.150E+0	9.944E-1	1.352E+0
Average-3s (OFF)	---	-6.267E-1	-4.654E-1	-4.249E-1	-1.129E+0

36. tod

Ta = 25°C; AVcc = DVcc = +5V; Vref tied to Voffset through 50 ohms

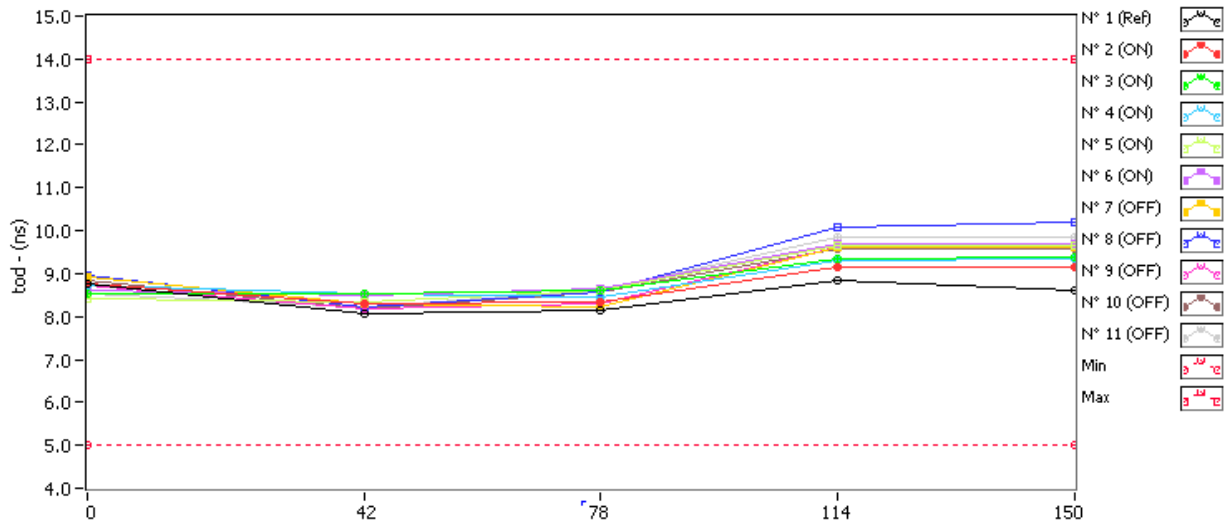

tod . (ns) Min = 5.0 Max = 14.0

	0krad(Si)	42krad(Si)	78krad(Si)	114krad(Si)	150krad(Si)
N° 1 (Ref)	8.760	8.080	8.160	8.848	8.600
N° 2 (ON)	8.760	8.300	8.333	9.167	9.151
N° 3 (ON)	8.550	8.516	8.600	9.362	9.390
N° 4 (ON)	8.717	8.516	8.467	9.300	9.362
N° 5 (ON)	8.409	8.347	8.600	9.667	9.667
N° 6 (ON)	8.617	8.480	8.640	9.689	9.700
N° 7 (OFF)	8.909	8.280	8.240	9.600	9.630
N° 8 (OFF)	8.950	8.211	8.560	10.071	10.203
N° 9 (OFF)	8.726	8.187	8.281	9.610	9.645
N° 10 (OFF)	8.857	8.200	8.573	9.571	9.560
N° 11 (OFF)	8.520	8.240	8.622	9.846	9.830

Delta [tod]

	0krad(Si)	42krad(Si)	78krad(Si)	114krad(Si)	150krad(Si)
N° 1 (Ref)	---	-6.800E-1	-6.000E-1	8.760E-2	-1.600E-1
N° 2 (ON)	---	-4.600E-1	-4.267E-1	4.067E-1	3.911E-1
N° 3 (ON)	---	-3.360E-2	5.000E-2	8.119E-1	8.405E-1
N° 4 (ON)	---	-2.003E-1	-2.500E-1	5.833E-1	6.452E-1
N° 5 (ON)	---	-6.280E-2	1.905E-1	1.257E+0	1.257E+0
N° 6 (ON)	---	-1.367E-1	2.330E-2	1.072E+0	1.083E+0
N° 7 (OFF)	---	-6.286E-1	-6.686E-1	6.914E-1	7.214E-1
N° 8 (OFF)	---	-7.391E-1	-3.900E-1	1.121E+0	1.253E+0
N° 9 (OFF)	---	-5.390E-1	-4.447E-1	8.838E-1	9.197E-1
N° 10 (OFF)	---	-6.571E-1	-2.838E-1	7.143E-1	7.029E-1
N° 11 (OFF)	---	-2.800E-1	1.022E-1	1.326E+0	1.310E+0
Average (ON)	---	-1.787E-1	-8.258E-2	8.263E-1	8.435E-1
s (ON)	---	1.702E-1	2.499E-1	3.469E-1	3.438E-1
Average+3s (ON)	---	3.319E-1	6.671E-1	1.867E+0	1.875E+0
Average-3s (ON)	---	-6.892E-1	-8.323E-1	-2.146E-1	-1.878E-1
Average (OFF)	---	-5.688E-1	-3.370E-1	9.473E-1	9.814E-1
s (OFF)	---	1.765E-1	2.829E-1	2.726E-1	2.875E-1
Average+3s (OFF)	---	-3.913E-2	5.117E-1	1.765E+0	1.844E+0
Average-3s (OFF)	---	-1.098E+0	-1.186E+0	1.294E-1	1.189E-1

37. SNR

Ta = 25°C; AVcc = DVcc = +5V; ENCODE = 41MSPS; Vref tied to Voffset through 50 ohms; Analog Input = 9.6MHz at -1dBFS

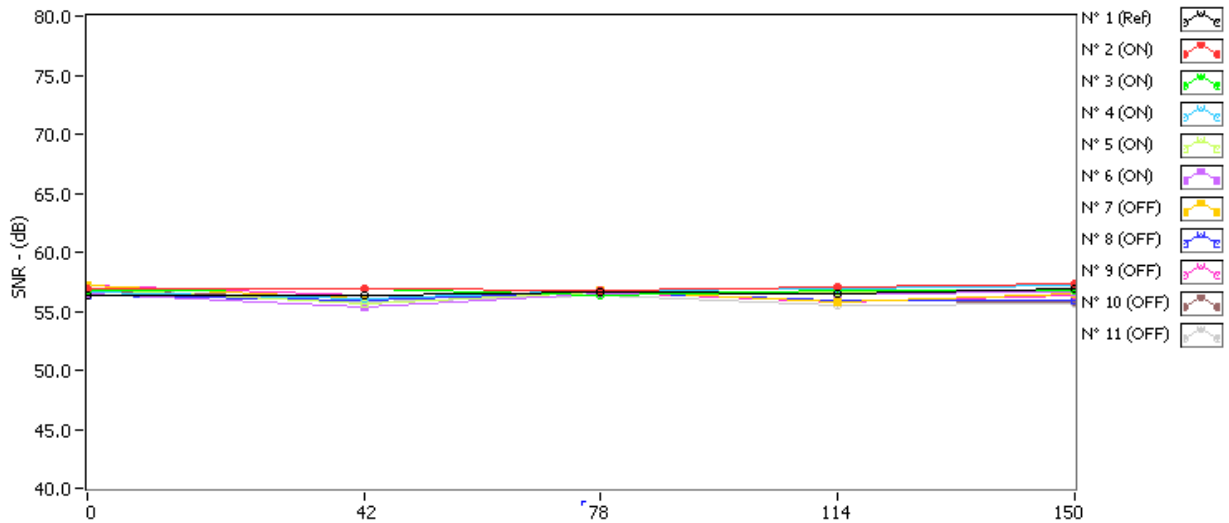

SNR . (dB)

	0krad(Si)	42krad(Si)	78krad(Si)	114krad(Si)	150krad(Si)
N° 1 (Ref)	56.31	56.36	56.64	56.54	56.85
N° 2 (ON)	56.96	56.85	56.75	57.02	57.36
N° 3 (ON)	56.76	56.92	56.38	56.76	56.74
N° 4 (ON)	56.67	56.04	56.74	56.86	57.12
N° 5 (ON)	56.86	55.58	56.60	56.65	56.72
N° 6 (ON)	56.50	55.29	56.45	56.42	56.64
N° 7 (OFF)	57.22	55.99	56.75	55.71	56.45
N° 8 (OFF)	56.41	55.89	56.62	55.90	55.90
N° 9 (OFF)	57.25	56.37	56.62	55.82	56.32
N° 10 (OFF)	56.73	56.06	56.59	55.87	55.78
N° 11 (OFF)	56.86	55.72	56.30	55.54	55.60

Delta [SNR]

	0krad(Si)	42krad(Si)	78krad(Si)	114krad(Si)	150krad(Si)
N° 1 (Ref)	---	5.296E-2	3.268E-1	2.272E-1	5.412E-1
N° 2 (ON)	---	-1.081E-1	-2.116E-1	5.907E-2	4.056E-1
N° 3 (ON)	---	1.613E-1	-3.748E-1	-1.850E-3	-2.396E-2
N° 4 (ON)	---	-6.282E-1	6.879E-2	1.968E-1	4.567E-1
N° 5 (ON)	---	-1.278E+0	-2.533E-1	-2.080E-1	-1.390E-1
N° 6 (ON)	---	-1.215E+0	-5.553E-2	-8.660E-2	1.357E-1
N° 7 (OFF)	---	-1.231E+0	-4.731E-1	-1.512E+0	-7.683E-1
N° 8 (OFF)	---	-5.208E-1	2.102E-1	-5.053E-1	-5.103E-1
N° 9 (OFF)	---	-8.791E-1	-6.312E-1	-1.434E+0	-9.356E-1
N° 10 (OFF)	---	-6.685E-1	-1.376E-1	-8.570E-1	-9.523E-1
N° 11 (OFF)	---	-1.132E+0	-5.542E-1	-1.313E+0	-1.254E+0
Average (ON)	---	-6.137E-1	-1.653E-1	-8.102E-3	1.670E-1
s (ON)	---	6.441E-1	1.737E-1	1.522E-1	2.608E-1
Average+3s (ON)	---	1.319E+0	3.557E-1	4.485E-1	9.493E-1
Average-3s (ON)	---	-2.546E+0	-6.863E-1	-4.647E-1	-6.153E-1
Average (OFF)	---	-8.862E-1	-3.172E-1	-1.124E+0	-8.841E-1
s (OFF)	---	3.000E-1	3.498E-1	4.292E-1	2.727E-1
Average+3s (OFF)	---	1.392E-2	7.323E-1	1.632E-1	-6.599E-2
Average-3s (OFF)	---	-1.786E+0	-1.367E+0	-2.412E+0	-1.702E+0

38. SINAD

Ta = 25°C; AVcc = DVcc = +5V; ENCODE = 41MSPS; Vref tied to Voffset through 50 ohms; Analog Input = 9.6MHz at -1dBFS

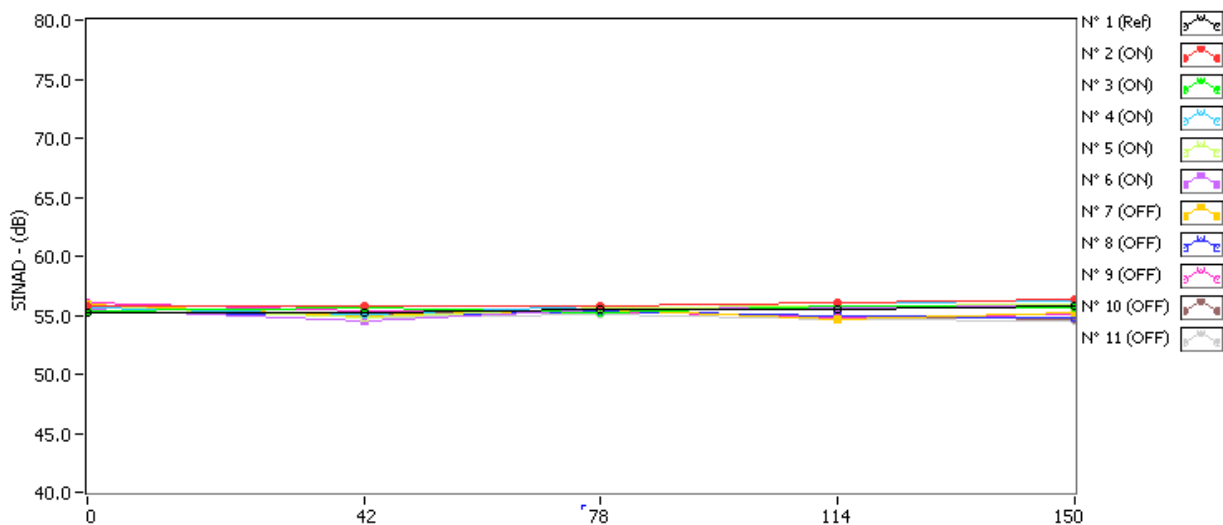

SINAD . (dB)

	0krad(Si)	42krad(Si)	78krad(Si)	114krad(Si)	150krad(Si)
N° 1 (Ref)	55.28	55.27	55.50	55.55	55.72
N° 2 (ON)	55.81	55.73	55.71	56.12	56.39
N° 3 (ON)	55.40	55.62	55.27	55.71	55.62
N° 4 (ON)	55.61	55.14	55.84	56.01	56.20
N° 5 (ON)	55.80	54.75	55.65	55.80	55.85
N° 6 (ON)	55.46	54.55	55.54	55.66	55.78
N° 7 (OFF)	55.92	54.93	55.47	54.69	55.20
N° 8 (OFF)	55.36	54.96	55.36	54.91	54.79
N° 9 (OFF)	56.10	55.36	55.38	54.81	55.05
N° 10 (OFF)	55.66	55.07	55.37	54.88	54.66
N° 11 (OFF)	55.73	54.77	55.06	54.60	54.44

Delta [SINAD]

	0krad(Si)	42krad(Si)	78krad(Si)	114krad(Si)	150krad(Si)
N° 1 (Ref)	---	-5.720E-3	2.245E-1	2.720E-1	4.395E-1
N° 2 (ON)	---	-7.895E-2	-1.055E-1	3.117E-1	5.781E-1
N° 3 (ON)	---	2.179E-1	-1.349E-1	3.051E-1	2.214E-1
N° 4 (ON)	---	-4.694E-1	2.356E-1	4.006E-1	5.973E-1
N° 5 (ON)	---	-1.043E+0	-1.488E-1	9.000E-4	5.093E-2
N° 6 (ON)	---	-9.089E-1	8.599E-2	2.005E-1	3.202E-1
N° 7 (OFF)	---	-9.896E-1	-4.450E-1	-1.231E+0	-7.199E-1
N° 8 (OFF)	---	-4.014E-1	-4.400E-3	-4.490E-1	-5.740E-1
N° 9 (OFF)	---	-7.402E-1	-7.234E-1	-1.287E+0	-1.051E+0
N° 10 (OFF)	---	-5.835E-1	-2.840E-1	-7.802E-1	-9.974E-1
N° 11 (OFF)	---	-9.677E-1	-6.715E-1	-1.131E+0	-1.292E+0
Average (ON)	---	-4.565E-1	-1.355E-2	2.437E-1	3.536E-1
s (ON)	---	5.353E-1	1.684E-1	1.532E-1	2.345E-1
Average+3s (ON)	---	1.149E+0	4.918E-1	7.032E-1	1.057E+0
Average-3s (ON)	---	-2.062E+0	-5.188E-1	-2.157E-1	-3.500E-1
Average (OFF)	---	-7.365E-1	-4.257E-1	-9.756E-1	-9.269E-1
s (OFF)	---	2.516E-1	2.945E-1	3.542E-1	2.834E-1
Average+3s (OFF)	---	1.826E-2	4.579E-1	8.690E-2	-7.677E-2
Average-3s (OFF)	---	-1.491E+0	-1.309E+0	-2.038E+0	-1.777E+0

39. WS

Ta = 25°C; AVcc = DVcc = +5V; ENCODE = 41MSPS; Vref tied to Voffset through 50 ohms; Analog Input = 9.6MHz at -1dBFS

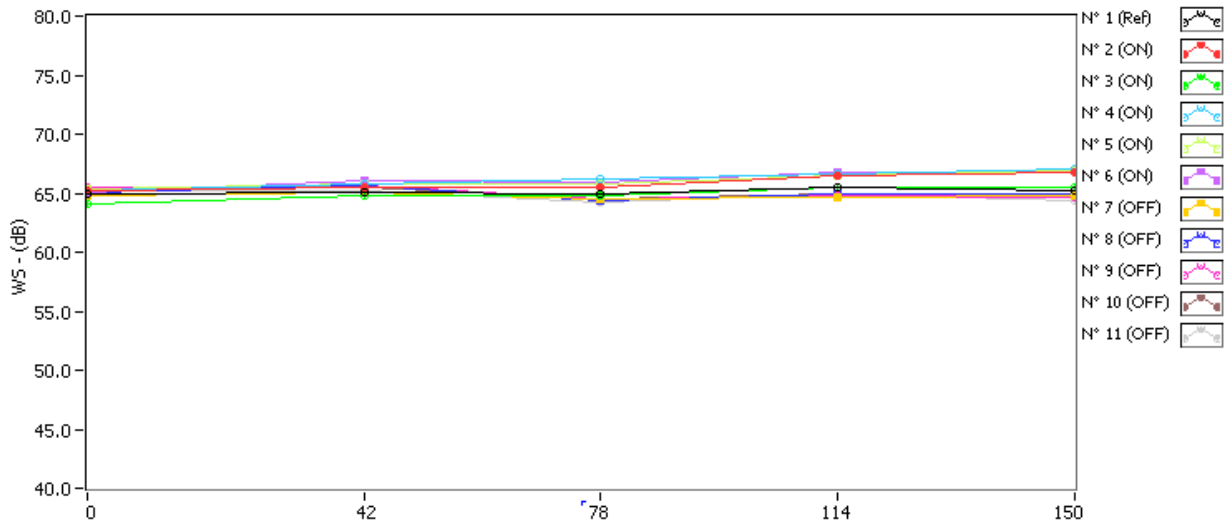

WS . (dB)

	0krad(Si)	42krad(Si)	78krad(Si)	114krad(Si)	150krad(Si)
N° 1 (Ref)	64.96	65.06	64.98	65.51	65.15
N° 2 (ON)	65.16	65.46	65.56	66.50	66.70
N° 3 (ON)	64.05	64.81	64.80	65.49	65.50
N° 4 (ON)	65.23	65.73	66.25	66.60	67.05
N° 5 (ON)	65.42	65.78	65.81	66.46	66.88
N° 6 (ON)	65.13	66.01	65.89	66.73	66.88
N° 7 (OFF)	64.78	65.00	64.51	64.61	64.82
N° 8 (OFF)	65.08	65.57	64.41	64.96	64.90
N° 9 (OFF)	65.45	65.65	64.47	64.82	64.62
N° 10 (OFF)	65.27	65.48	64.57	64.91	64.74
N° 11 (OFF)	65.18	65.27	64.21	64.90	64.37

Delta [WS]

	0krad(Si)	42krad(Si)	78krad(Si)	114krad(Si)	150krad(Si)
N° 1 (Ref)	---	1.021E-1	2.068E-2	5.511E-1	1.864E-1
N° 2 (ON)	---	2.934E-1	3.999E-1	1.332E+0	1.542E+0
N° 3 (ON)	---	7.589E-1	7.462E-1	1.441E+0	1.446E+0
N° 4 (ON)	---	5.004E-1	1.018E+0	1.363E+0	1.819E+0
N° 5 (ON)	---	3.648E-1	3.933E-1	1.039E+0	1.468E+0
N° 6 (ON)	---	8.836E-1	7.661E-1	1.607E+0	1.751E+0
N° 7 (OFF)	---	2.213E-1	-2.673E-1	-1.702E-1	3.585E-2
N° 8 (OFF)	---	4.924E-1	-6.638E-1	-1.115E-1	-1.722E-1
N° 9 (OFF)	---	1.952E-1	-9.812E-1	-6.328E-1	-8.307E-1
N° 10 (OFF)	---	2.159E-1	-6.948E-1	-3.541E-1	-5.301E-1
N° 11 (OFF)	---	9.357E-2	-9.711E-1	-2.812E-1	-8.068E-1
Average (ON)	---	5.602E-1	6.647E-1	1.356E+0	1.605E+0
s (ON)	---	2.535E-1	2.672E-1	2.070E-1	1.697E-1
Average+3s (ON)	---	1.321E+0	1.466E+0	1.978E+0	2.115E+0
Average-3s (ON)	---	-2.002E-1	-1.368E-1	7.354E-1	1.096E+0
Average (OFF)	---	2.437E-1	-7.156E-1	-3.100E-1	-4.608E-1
s (OFF)	---	1.483E-1	2.915E-1	2.037E-1	3.845E-1
Average+3s (OFF)	---	6.886E-1	1.589E-1	3.010E-1	6.926E-1
Average-3s (OFF)	---	-2.013E-1	-1.590E+0	-9.209E-1	-1.614E+0

40. DNL_MIN

Ta = 25°C; AVcc = DVcc = +5V; Vref tied to Voffset through 50 ohms; Encode = 20MSPS

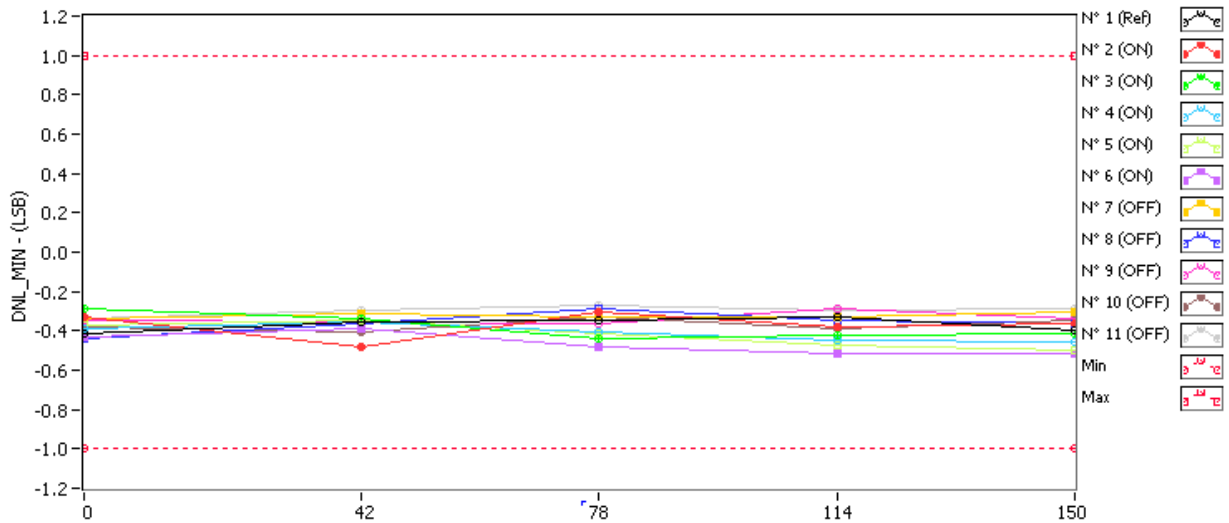

DNL_MIN . (LSB)

Min = -1.0 Max = 1.0

	0krad(Si)	42krad(Si)	78krad(Si)	114krad(Si)	150krad(Si)
N° 1 (Ref)	-0.416	-0.359	-0.345	-0.328	-0.398
N° 2 (ON)	-0.327	-0.483	-0.305	-0.383	-0.362
N° 3 (ON)	-0.286	-0.334	-0.439	-0.422	-0.413
N° 4 (ON)	-0.385	-0.359	-0.407	-0.451	-0.460
N° 5 (ON)	-0.370	-0.348	-0.418	-0.470	-0.501
N° 6 (ON)	-0.429	-0.386	-0.478	-0.517	-0.512
N° 7 (OFF)	-0.335	-0.311	-0.331	-0.328	-0.307
N° 8 (OFF)	-0.440	-0.359	-0.289	-0.347	-0.361
N° 9 (OFF)	-0.348	-0.353	-0.365	-0.289	-0.341
N° 10 (OFF)	-0.377	-0.405	-0.330	-0.388	-0.346
N° 11 (OFF)	-0.337	-0.297	-0.270	-0.298	-0.285

Delta [DNL_MIN]

	0krad(Si)	42krad(Si)	78krad(Si)	114krad(Si)	150krad(Si)
N° 1 (Ref)	---	5.708E-2	7.043E-2	8.765E-2	1.798E-2
N° 2 (ON)	---	-1.562E-1	2.160E-2	-5.648E-2	-3.484E-2
N° 3 (ON)	---	-4.804E-2	-1.532E-1	-1.358E-1	-1.271E-1
N° 4 (ON)	---	2.639E-2	-2.203E-2	-6.537E-2	-7.428E-2
N° 5 (ON)	---	2.190E-2	-4.768E-2	-1.001E-1	-1.306E-1
N° 6 (ON)	---	4.369E-2	-4.829E-2	-8.774E-2	-8.300E-2
N° 7 (OFF)	---	2.483E-2	4.627E-3	7.384E-3	2.847E-2
N° 8 (OFF)	---	8.078E-2	1.508E-1	9.320E-2	7.968E-2
N° 9 (OFF)	---	-5.490E-3	-1.731E-2	5.872E-2	6.474E-3
N° 10 (OFF)	---	-2.864E-2	4.621E-2	-1.185E-2	3.062E-2
N° 11 (OFF)	---	4.080E-2	6.787E-2	3.960E-2	5.214E-2
Average (ON)	---	-2.245E-2	-4.992E-2	-8.910E-2	-8.997E-2
s (ON)	---	8.257E-2	6.436E-2	3.136E-2	3.990E-2
Average+3s (ON)	---	2.253E-1	1.432E-1	4.985E-3	2.971E-2
Average-3s (ON)	---	-2.702E-1	-2.430E-1	-1.832E-1	-2.097E-1
Average (OFF)	---	2.246E-2	5.043E-2	3.741E-2	3.947E-2
s (OFF)	---	4.224E-2	6.534E-2	4.153E-2	2.768E-2
Average+3s (OFF)	---	1.492E-1	2.465E-1	1.620E-1	1.225E-1
Average-3s (OFF)	---	-1.043E-1	-1.456E-1	-8.718E-2	-4.357E-2

41. DNL_MAX

Ta = 25°C; AVcc = DVcc = +5V; Vref tied to Voffset through 50 ohms; Encode = 20MSPS

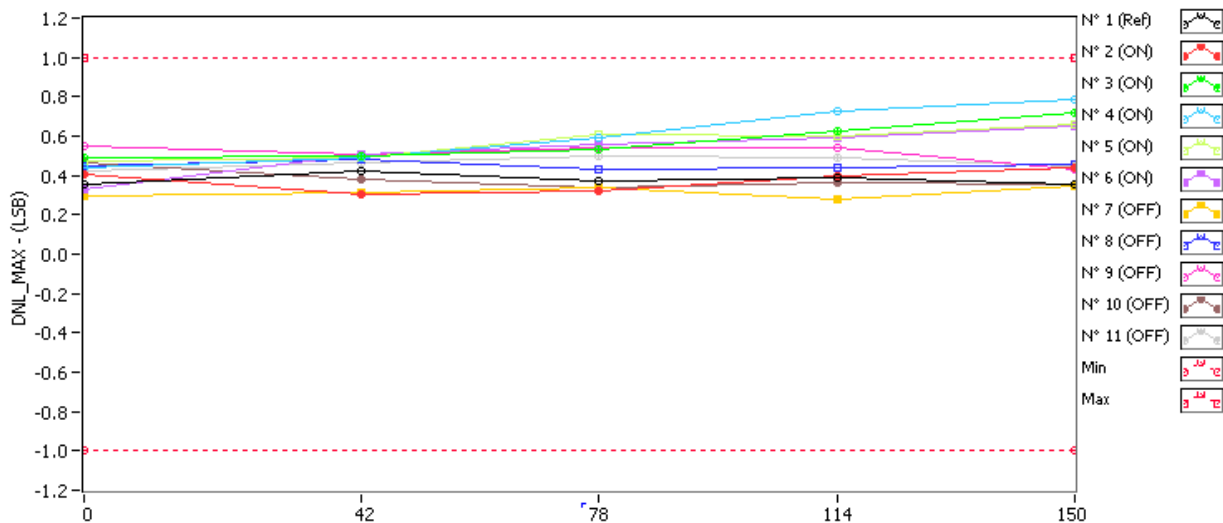

DNL_MAX . (LSB) Min = -1.0 Max = 1.0

	0krad(Si)	42krad(Si)	78krad(Si)	114krad(Si)	150krad(Si)
N° 1 (Ref)	0.356	0.423	0.371	0.388	0.353
N° 2 (ON)	0.407	0.308	0.320	0.398	0.437
N° 3 (ON)	0.493	0.498	0.528	0.629	0.720
N° 4 (ON)	0.438	0.491	0.595	0.726	0.782
N° 5 (ON)	0.473	0.491	0.612	0.603	0.659
N° 6 (ON)	0.333	0.503	0.558	0.588	0.654
N° 7 (OFF)	0.299	0.313	0.334	0.279	0.343
N° 8 (OFF)	0.449	0.485	0.434	0.444	0.455
N° 9 (OFF)	0.548	0.511	0.542	0.539	0.434
N° 10 (OFF)	0.465	0.376	0.339	0.361	0.355
N° 11 (OFF)	0.421	0.468	0.495	0.491	0.447

Delta [DNL_MAX]

	0krad(Si)	42krad(Si)	78krad(Si)	114krad(Si)	150krad(Si)
N° 1 (Ref)	---	6.627E-2	1.444E-2	3.142E-2	-3.146E-3
N° 2 (ON)	---	-9.951E-2	-8.708E-2	-8.726E-3	3.018E-2
N° 3 (ON)	---	4.659E-3	3.516E-2	1.355E-1	2.273E-1
N° 4 (ON)	---	5.287E-2	1.563E-1	2.877E-1	3.437E-1
N° 5 (ON)	---	1.778E-2	1.393E-1	1.300E-1	1.859E-1
N° 6 (ON)	---	1.702E-1	2.253E-1	2.549E-1	3.214E-1
N° 7 (OFF)	---	1.482E-2	3.551E-2	-1.966E-2	4.423E-2
N° 8 (OFF)	---	3.517E-2	-1.536E-2	-5.949E-3	5.501E-3
N° 9 (OFF)	---	-3.746E-2	-6.010E-3	-9.761E-3	-1.143E-1
N° 10 (OFF)	---	-8.858E-2	-1.255E-1	-1.039E-1	-1.094E-1
N° 11 (OFF)	---	4.649E-2	7.442E-2	6.947E-2	2.560E-2
Average (ON)	---	2.919E-2	9.380E-2	1.599E-1	2.217E-1
s (ON)	---	9.713E-2	1.219E-1	1.176E-1	1.253E-1
Average+3s (ON)	---	3.206E-1	4.595E-1	5.125E-1	5.977E-1
Average-3s (ON)	---	-2.622E-1	-2.719E-1	-1.928E-1	-1.543E-1
Average (OFF)	---	-5.911E-3	-7.397E-3	-1.395E-2	-2.968E-2
s (OFF)	---	5.633E-2	7.510E-2	6.155E-2	7.629E-2
Average+3s (OFF)	---	1.631E-1	2.179E-1	1.707E-1	1.992E-1
Average-3s (OFF)	---	-1.749E-1	-2.327E-1	-1.986E-1	-2.585E-1

42. INL_MIN

Ta = 25°C; AVcc = DVcc = +5V; Vref tied to Voffset through 50 ohms; Encode = 20MSPS

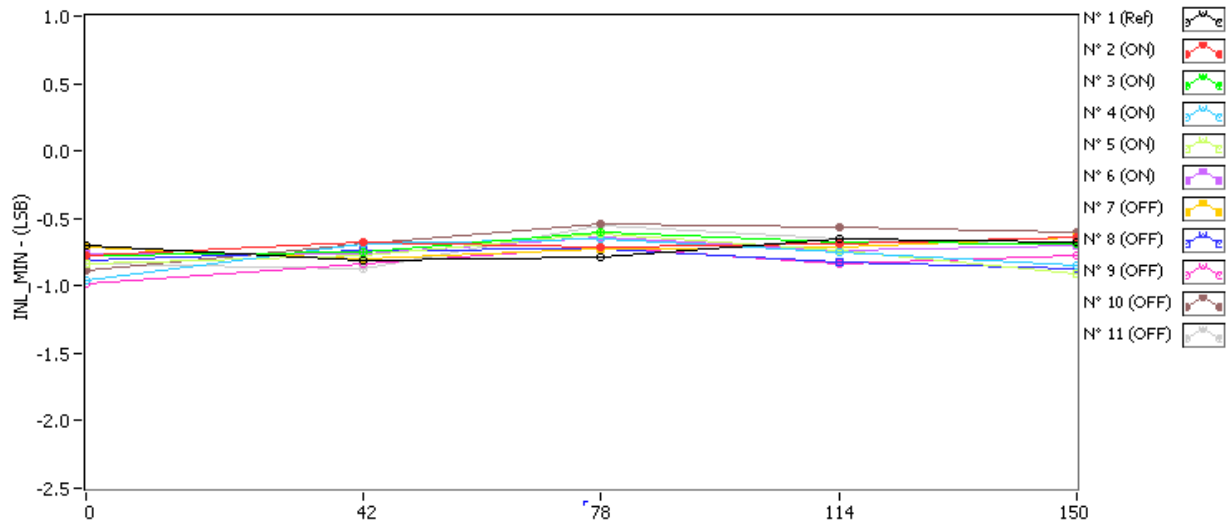

INL_MIN . (LSB)

	0krad(Si)	42krad(Si)	78krad(Si)	114krad(Si)	150krad(Si)
N° 1 (Ref)	-0.699	-0.817	-0.781	-0.649	-0.682
N° 2 (ON)	-0.778	-0.676	-0.717	-0.690	-0.641
N° 3 (ON)	-0.771	-0.750	-0.600	-0.671	-0.690
N° 4 (ON)	-0.961	-0.684	-0.655	-0.747	-0.846
N° 5 (ON)	-0.837	-0.779	-0.616	-0.743	-0.906
N° 6 (ON)	-0.763	-0.764	-0.636	-0.732	-0.698
N° 7 (OFF)	-0.719	-0.796	-0.725	-0.711	-0.639
N° 8 (OFF)	-0.811	-0.736	-0.730	-0.829	-0.870
N° 9 (OFF)	-0.980	-0.833	-0.709	-0.839	-0.770
N° 10 (OFF)	-0.891	-0.686	-0.542	-0.565	-0.605
N° 11 (OFF)	-0.831	-0.870	-0.550	-0.655	-0.702

Delta [INL_MIN]

	0krad(Si)	42krad(Si)	78krad(Si)	114krad(Si)	150krad(Si)
N° 1 (Ref)	---	-1.179E-1	-8.234E-2	4.935E-2	1.675E-2
N° 2 (ON)	---	1.011E-1	6.095E-2	8.706E-2	1.368E-1
N° 3 (ON)	---	2.108E-2	1.705E-1	9.945E-2	8.063E-2
N° 4 (ON)	---	2.765E-1	3.059E-1	2.135E-1	1.150E-1
N° 5 (ON)	---	5.795E-2	2.214E-1	9.448E-2	-6.842E-2
N° 6 (ON)	---	-8.797E-4	1.275E-1	3.069E-2	6.548E-2
N° 7 (OFF)	---	-7.752E-2	-6.057E-3	8.090E-3	7.969E-2
N° 8 (OFF)	---	7.496E-2	8.079E-2	-1.756E-2	-5.876E-2
N° 9 (OFF)	---	1.477E-1	2.713E-1	1.412E-1	2.102E-1
N° 10 (OFF)	---	2.052E-1	3.485E-1	3.261E-1	2.857E-1
N° 11 (OFF)	---	-3.908E-2	2.811E-1	1.758E-1	1.287E-1
Average (ON)	---	9.115E-2	1.773E-1	1.050E-1	6.590E-2
s (ON)	---	1.106E-1	9.293E-2	6.665E-2	8.016E-2
Average+3s (ON)	---	4.229E-1	4.561E-1	3.050E-1	3.064E-1
Average-3s (ON)	---	-2.406E-1	-1.015E-1	-9.490E-2	-1.746E-1
Average (OFF)	---	6.224E-2	1.951E-1	1.267E-1	1.291E-1
s (OFF)	---	1.201E-1	1.502E-1	1.390E-1	1.312E-1
Average+3s (OFF)	---	4.225E-1	6.458E-1	5.437E-1	5.226E-1
Average-3s (OFF)	---	-2.980E-1	-2.555E-1	-2.902E-1	-2.644E-1

43. INL_MAX

Ta = 25°C; AVcc = DVcc = +5V; Vref tied to Voffset through 50 ohms; Encode = 20MSPS

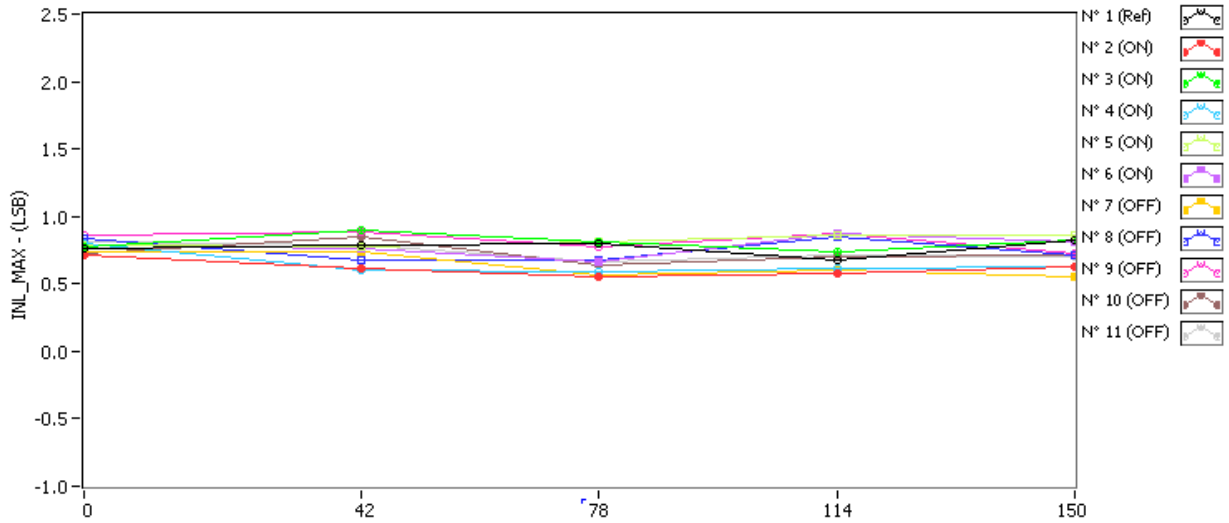

INL_MAX . (LSB)

	0krad(Si)	42krad(Si)	78krad(Si)	114krad(Si)	150krad(Si)
N° 1 (Ref)	0.768	0.787	0.802	0.670	0.825
N° 2 (ON)	0.709	0.613	0.558	0.581	0.623
N° 3 (ON)	0.778	0.897	0.807	0.737	0.829
N° 4 (ON)	0.799	0.596	0.593	0.620	0.632
N° 5 (ON)	0.788	0.770	0.816	0.864	0.863
N° 6 (ON)	0.788	0.761	0.658	0.872	0.813
N° 7 (OFF)	0.732	0.742	0.562	0.604	0.556
N° 8 (OFF)	0.837	0.677	0.681	0.846	0.710
N° 9 (OFF)	0.867	0.881	0.769	0.869	0.728
N° 10 (OFF)	0.727	0.853	0.639	0.701	0.713
N° 11 (OFF)	0.810	0.782	0.659	0.709	0.695

Delta [INL_MAX]

	0krad(Si)	42krad(Si)	78krad(Si)	114krad(Si)	150krad(Si)
N° 1 (Ref)	---	1.876E-2	3.373E-2	-9.830E-2	5.639E-2
N° 2 (ON)	---	-9.561E-2	-1.513E-1	-1.283E-1	-8.592E-2
N° 3 (ON)	---	1.186E-1	2.904E-2	-4.137E-2	5.074E-2
N° 4 (ON)	---	-2.032E-1	-2.061E-1	-1.797E-1	-1.677E-1
N° 5 (ON)	---	-1.774E-2	2.812E-2	7.558E-2	7.511E-2
N° 6 (ON)	---	-2.658E-2	-1.300E-1	8.396E-2	2.546E-2
N° 7 (OFF)	---	9.478E-3	-1.702E-1	-1.279E-1	-1.759E-1
N° 8 (OFF)	---	-1.597E-1	-1.558E-1	9.827E-3	-1.265E-1
N° 9 (OFF)	---	1.393E-2	-9.793E-2	2.030E-3	-1.387E-1
N° 10 (OFF)	---	1.265E-1	-8.789E-2	-2.560E-2	-1.363E-2
N° 11 (OFF)	---	-2.865E-2	-1.511E-1	-1.015E-1	-1.154E-1
Average (ON)	---	-4.492E-2	-8.606E-2	-3.797E-2	-2.046E-2
s (ON)	---	1.177E-1	1.083E-1	1.183E-1	1.028E-1
Average+3s (ON)	---	3.082E-1	2.387E-1	3.171E-1	2.880E-1
Average-3s (ON)	---	-3.981E-1	-4.109E-1	-3.930E-1	-3.289E-1
Average (OFF)	---	-7.689E-3	-1.326E-1	-4.863E-2	-1.140E-1
s (OFF)	---	1.029E-1	3.705E-2	6.243E-2	6.058E-2
Average+3s (OFF)	---	3.009E-1	-2.142E-2	1.387E-1	6.770E-2
Average-3s (OFF)	---	-3.163E-1	-2.437E-1	-2.359E-1	-2.958E-1