

TOTAL IONIZING DOSE TEST REPORT

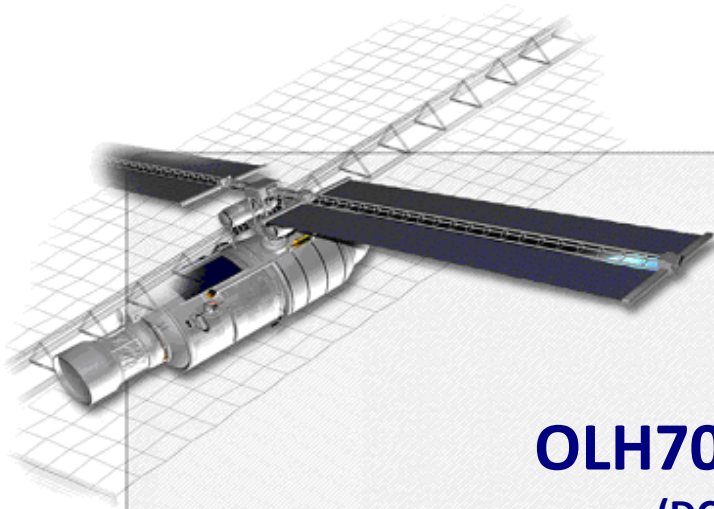

OLH7000-0010 (DC0721) Linear Optocoupler From ISOLINK



TRAD/TE/OLH7000/XXX1/ESA/YP/1104		Labège, April 30 th, 2012
 		TRAD, Bât Gallium 907, Voie l'Occitane - 31670 LABEGE France ☎ : 05 61 00 95 60 Fax : 05 61 00 95 61 Email : trad@trad.fr Web Site: www.trad.fr SIRET 397 862 038 00056 - TVA FR59397862038
Written by	Verified by / Quality control	Approved by
A. SAMARAS 30/04/2012	M.SAUVAGNAC/Y.PADIE 30/05/2012	C.CHATRY 30/05/2012
Issue : 0		
To: Marc POIZAT	Project/Program:	ESA Contract N°4000102571/10/NL/AF-Radiation Characterization of Laplace RH optocouplers, sensors and detectors

TABLE OF CONTENT

1	INTRODUCTION	3
2	DOCUMENTS	3
2.1	Applicable Documents	3
2.2	Reference Documents.....	3
3	DEVICE INFORMATION.....	3
3.1	Device description.....	3
3.2	Procurement information.....	4
3.3	External view.....	4
3.4	Internal view	4
3.5	Serialization.....	5
4	IRRADIATION MEANS AND CONDITIONS	6
4.1	UCL irradiation facility (Belgium)	6
4.2	Dose measurement.....	6
4.3	Experimental conditions	6
5	ELECTRICAL TESTS.....	7
5.1	Test set-up	7
5.2	Test configuration.....	7
5.3	Electrical parameters	8
6	TEST HISTORY	9
6.1	Steps.....	9
6.2	Datasheet.....	9
7	SUMMARY RESULTS.....	11
7.1	K1 and K2_1 case: Considering the applicable datasheet	12
7.2	K1 and K2_1 case: Considering re-evaluated specification	13
8	CONCLUSION	14
9	DETAILED TESTS RESULTS.....	15

LIST OF FIGURES

Figure 1: package marking.....	4
Figure 2: package view	4
Figure 3: Internal overall view	4
Figure 4: view of photodiode detector	5
Figure 5: view of LED	5
Figure 6: test principle	7
Figure 7: ON bias1	7
Figure 8: ON bias2.....	7
Figure 9: IP1 and IP2 parameters function of Total Ionizing Dose.....	9
Figure 10: K1 and K2_1 parameters function of Total Ionizing Dose	10
Figure 11: ON Bias 1	11
Figure 12: ON Bias 2	11
Figure 13 : OFF Bias.....	11
Figure 14: ON Bias 1	12
Figure 15: ON Bias 2	12
Figure 16: OFF Bias.....	12
Figure 17: ON Bias 1	13
Figure 18: ON Bias 2	13
Figure 19: OFF Bias.....	13

1 INTRODUCTION

This report includes the test results of OLH7000-0010, an hermetic linear Optocoupler from ISOLINK to evaluate Total Ionizing Dose (TID) effects under ^{60}Co irradiation. Between November 2011 and February 2012, TRAD characterized this device for TID sensitivity at the UCL Facility, Belgium using their Gamma irradiation Facility.

The objectives of the test are:

- to detect and measure the degradation of device parameters as a function of TID,
- to determine if device parameters are within specified limits after exposure to final TID level.

2 DOCUMENTS

2.1 Applicable Documents

AD	1.	ESA contract	N°4000102571/10/NL/AF-Radiation Characterization of Laplace RH optocouplers, sensors and detectors
AD	2.	Irradiation Test Plan	ITP-TE-OLH7000-ISO-ESA-1115 Iss.2, dated 21/06/2011

2.2 Reference Documents

RD	1.	Datasheet OLH7000	Hermetic Linear Optocoupler
----	----	-------------------	-----------------------------

3 DEVICE INFORMATION

3.1 Device description

The OLH7000 is a hermetic linear Optocoupler which consists of two LED in series coupled to two PIN photodiode detectors. The photodiode on the input side acts as a feedback device permitting an external feedback loop to ensure constant LED light output. A similar matching photodiode on the output side is used to drive an output circuit that is electrically isolated from the input. A fixed relationship is thus maintained between input and output. This technique compensates for the LED's nonlinear time and temperature characteristics. Each OLH7000 is mounted and coupled in a hermetic 8-pin ceramic DIP providing 1000 Vdc electrical isolation between input and output.

Type	OLH7000-0010
Manufacturer	ISOLINK
Function	Optocoupler
Package	DIP8
Date Code	0721
Sample size	16 parts (15 test parts + 1 control sample)

3.2 Procurement information

75 parts OLH7000-001 were delivered by ISOLINK through the French representative EUROMIP.

3.3 External view



Figure 1: package marking

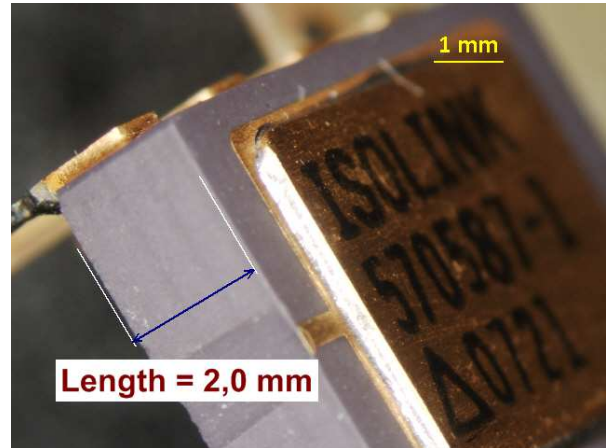

Figure 2: package view

3.4 Internal view

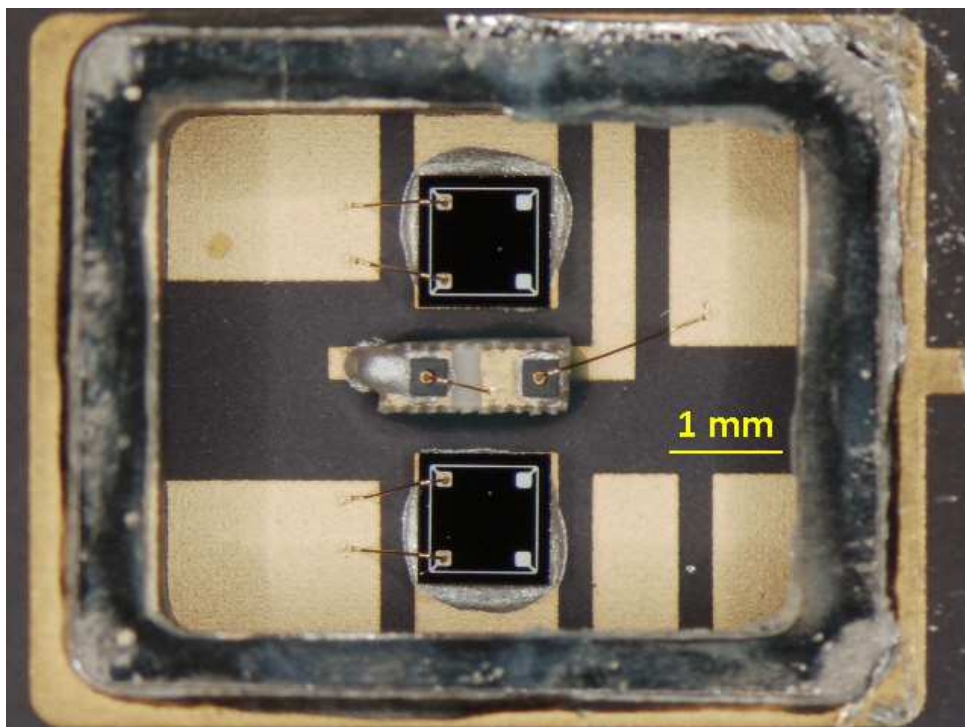

Figure 3: Internal overall view

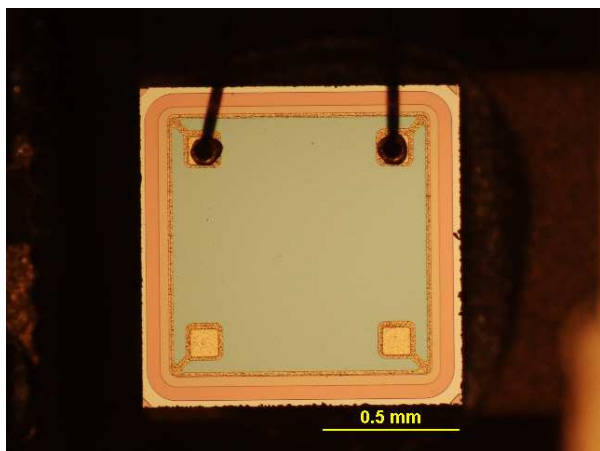

Figure 4: view of photodiode detector

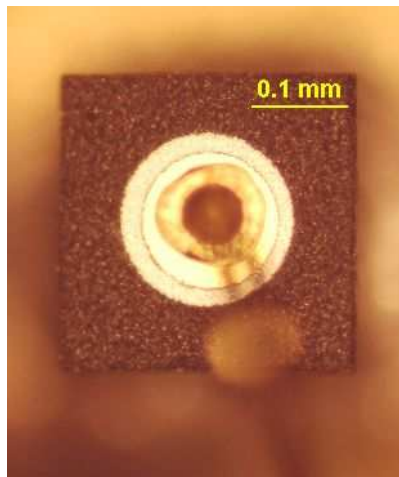

Figure 5: view of LED

3.5 Serialization

Each part is serialized to enable pre and post test identification and comparison.

Serial Number	Control sample	Test samples														
Serialization	1	2	3	4	5	6	7	8	9	10	11	12	13	14	15	16
	Ref	Bias1	Bias1	Bias1	Bias1	Bias1	Bias2	Bias2	Bias2	Bias2	Bias2	OFF	OFF	OFF	OFF	OFF

4 IRRADIATION MEANS AND CONDITIONS

4.1 UCL irradiation facility (Belgium)

Gamma irradiations are performed with Cobalt 60 source.
Gamma emitted radiation energies are 1.17 and 1.33 MeV.
Dose rates is equal 15 kRad(Si) / h at the source centre .
Moreover the irradiation chamber is a cylindrical room with a radius of 2m.
Then dose rate usable vary from 1.8 kRad(Si) / h to 80 Rad(Si) / h for normal irradiation positions and direct field.

4.2 Dose measurement

Alanine dosimeters are used for each test set up to control Total Ionizing Dose.

4.3 Experimental conditions

An Accumulated dose of 200 krad(Si) of ⁶⁰Co is required [AD2] for this TID (Total Ionizing Dose) evaluation test.

The test devices were exposed to the following dose rates:

	Step1	Step2	Step3	Step4	Step5	Step6	Step7	Step8
Accumulated dose krad(Si)	10	19	49	65	101	130	152	203
Dose rate (Si)/h	36	36	36	36	310	310	310	310

Two annealing steps are performed after ⁶⁰Co irradiation:

Duration (h)	24	168
Temperature (°C)	25	100



5 ELECTRICAL TESTS

Electrical parameters to be measured in pre and post exposure tests are described in the following table. Electrical tests are performed on each part using the test set-up hereunder. All required data are recorded for each device. Test conditions and limits are given in the applicable irradiation test plan [AD2] and shown hereafter.

5.1 Test set-up

TEST BOARD	TRAD/CT1/E/OLH7000/DIL8/MV/1108
TEST PROGRAM	OLH7000_TE_XXX1_B1_V10.IIb

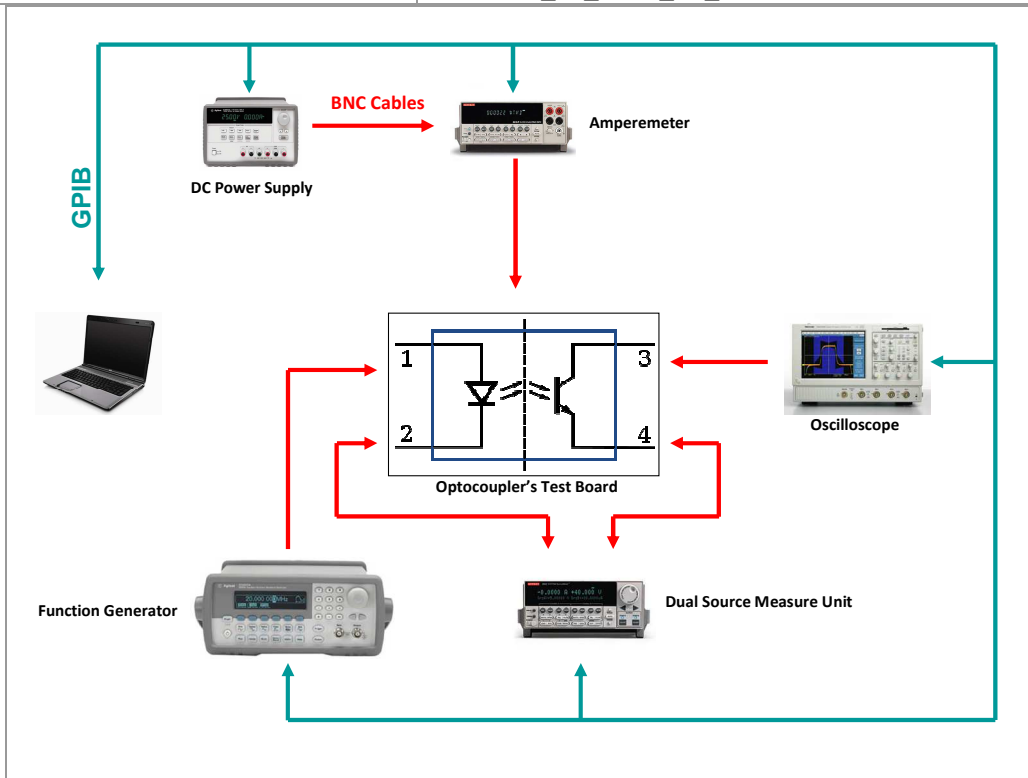

Figure 6: test principle

5.2 Test configuration

Samples were exposed to irradiation in three different modes - two on-modes (Figure 7 and Figure 8) and one off-mode (all terminal leads short-circuited) –

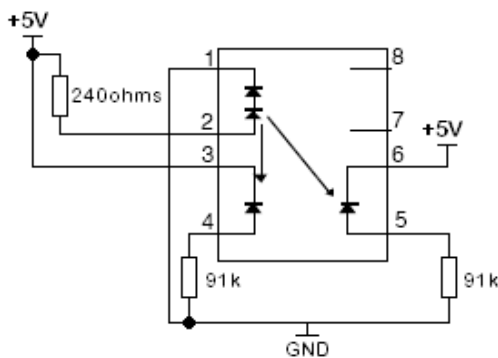

Figure 7: ON bias1

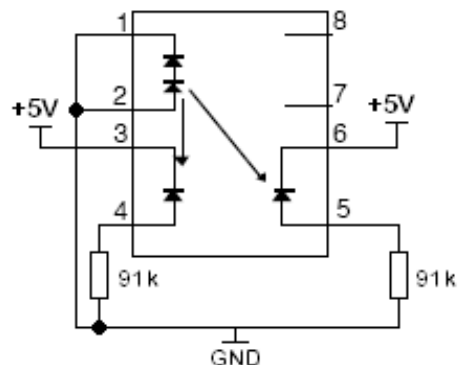

Figure 8: ON bias2

5.3 Electrical parameters

PARAMETER	SYMBOL	TEST CONDITION	MIN	MAX	UNIT	Typical value
Forward Voltage	V_F	$I_F = 10 \text{ mA}$		3,3	V	
Reverse Voltage	V_R	$I_R = 100\mu\text{A}$	5		V	
Dark Current	I_D	$V_R = 15 \text{ V}, I_F = 0 \text{ mA}$		25	nA	
Open Circuit Voltage	V_{OC}	$I_F = 10 \text{ mA}$			mV	500
Servo Current Gain	K1	$I_F = 10 \text{ mA}, V_{det} = -15 \text{ V}$	0,0035	0,0065		
Servo Current	I_{p1}	$I_F = 10 \text{ mA}, V_{det} = -15 \text{ V}$			μA	50
Forward Current Gain	K2-1	$I_F = 10 \text{ mA}, V_{det} = -15 \text{ V}$	0,0035	0,0065		
	K2-2	$I_F = 1 \text{ mA}, V_{det} = -15 \text{ V}$				
	K2-3	$I_F = 2 \text{ mA}, V_{det} = -15 \text{ V}$				
	K2-4	$I_F = 60 \text{ mA}, V_{det} = -15 \text{ V}$				
	K2-5	$I_F = 10 \text{ mA}, V_{det} = -30 \text{ V}$				
Forward Current	I_{p2}	$I_F = 10 \text{ mA}, V_{det} = -15 \text{ V}$			μA	50
Transfer Gain	K3	$I_F = 10 \text{ mA}, V_{det} = -15 \text{ V}$	0,75	1,25		K1/K2
Frequency Response (-3db)	BW	$I_F = 10 \text{ mA} \pm 4 \text{ mA},$ $R_L = 50\Omega$			KHz	200
Rise Time	tr	$I_F = 10 \text{ mA} \pm 4 \text{ mA},$ $R_L = 50\Omega$			μs	2
Fall Time	tf	$I_F = 10 \text{ mA} \pm 4 \text{ mA},$ $R_L = 50\Omega$			μs	2

Min/ Max values are those specified in the reference data-sheet [RD1] applicable to OLH7000 type.
Test measurements are performed at $25^\circ\text{C} \pm 10^\circ\text{C}$.

See extracts from mails from ISOLINK here after concerning the OLH7000.0010 type:

“The OLH7000.0010 is different from the standard OLH7000. The standard OLH7000's LED cannot withstand displacement damage radiation.

The OLH7000.0010 (570587-1) uses a different LED that is more displacement damage tolerant and this LED had higher light output and thus higher I_{p1} and I_{p2} .

We have been supplying the OLH7000.00XX for several years to many space customers”

“The marking 570587-1 is for the ITT OLH7000.0010. The '570587-1' is the ITT Drawing# for the SCD. The parts are tested to ensure that they meet the minimum I_{p1} of 35uA and I_{p2} of 35uA. The typical is around 50uA and it could be higher.

Regardless of the initial value of K1 (I_{p1}) and K2 (I_{p2}), the most important parameter is K3 (Transfer Gain).”

6 TEST HISTORY

6.1 Steps

Seven steps were defined to determine the component degradation under ⁶⁰Co irradiation.

	Step1	Step2	Step3	Step4	Step5	Step6	Step7
Accumulated dose krad(Si)	10	20	50	100	120	150	200
Dose rate (Si)/h	36	36	36	36	310	310	310

Due to irradiation facility maintenance, between Step 3 and Step 4 (50 krad(Si) and 100 krad(Si)), tests were stopped for 48 hours. Total Ionizing Dose was estimated at 65 krad(Si). During this time period, parts were stored in a cold chamber at -30°C.

6.2 Datasheet

PARAMETERS	SYMBOL	TEST CONDITIONS	APPLICABLE DATA-SHEET			
	S					
Ta = 25°C, unless otherwise specified						
			Min	Typ. Value	Max	Unit
Servo Current	I _{p1}	I _F = 10 mA, V _{det} = -15 V		50		μA
Forward Current	I _{p2}	I _F = 10 mA, V _{det} = -15 V		50		μA
Servo Current Gain	K1	I _F = 10 mA, V _{det} = -15 V	0.0035	0.005	0.0065	
Forward Current Gain	K2-1	I _F = 10 mA, V _{det} = -15 V	0.0035	0.005	0.0065	

Previous table summarizes applicable limits for IP1, IP2, K1 and K2-1 parameters.

The typical value of IP1 and IP2 should be 50 μA.

But during test, as shown in the next figure, IP1 and IP2 current on the un-irradiated device is around 100 μA.

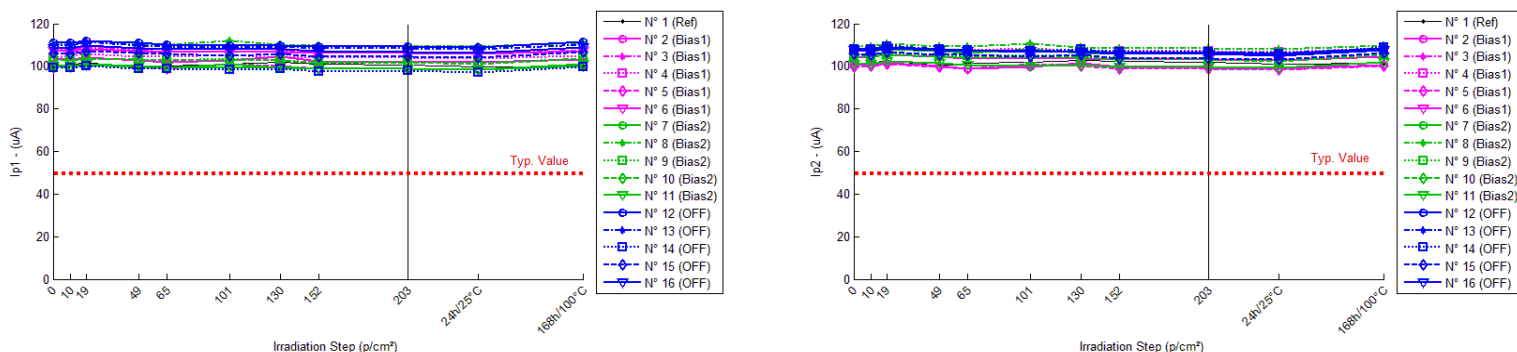

Figure 9: IP1 and IP2 parameters function of Total Ionizing Dose

Moreover,

Servo Current Gain:
$$K1 = \frac{IP1}{IF}$$

Forward Current Gain: $K2_1 = \frac{IP2}{IF}$

With $IF=10mA$

Then K1 and K2_1 (for the device OLH7000-0010) have a typical value of 0.01 instead of 0.005 as specified in the applicable datasheet [RD1].

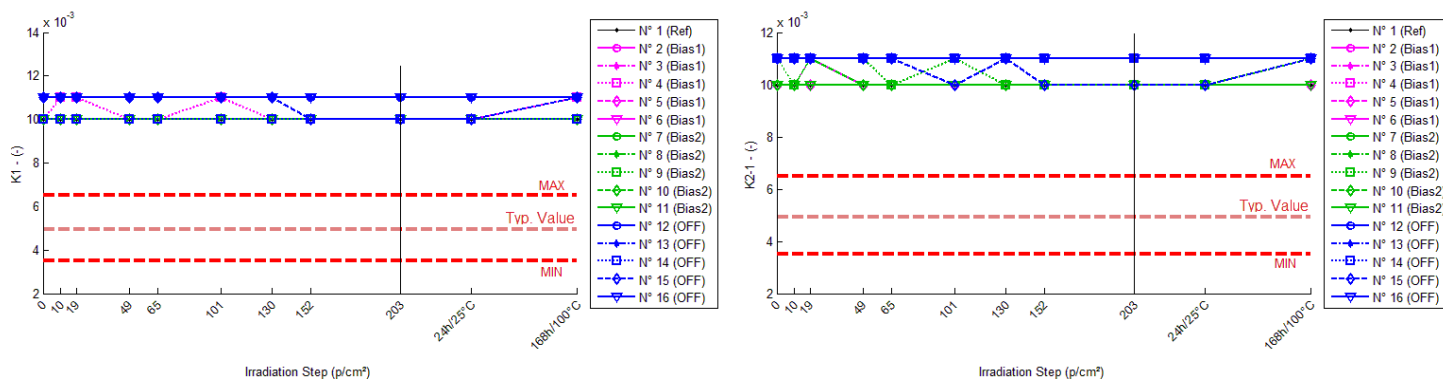

Figure 10: K1 and K2_1 parameters function of Total Ionizing Dose

As shown in Figure 8, non irradiated devices are out of specification due to the difference between IP1 and IP2 requirement and measurement. According to information provided by ISOLINK, this is explained by the difference between OLH7000.0010 that was delivered instead of OLH7000 initially requested by TRAD.

The OLH7000.0010 (570587-1) uses a different LED that is more displacement damage tolerant. This LED had higher light output and thus higher Ip1 and Ip2. However no dedicated datasheet was available.

If 100 µA is considered as the typical value for IP1 and IP2, then the typical value for K1 and K2_1 is 0.01.

If the minimum and maximum value for K1 and K2_1 is evaluated as a difference of 0.0015 from the typical value, then specified values are described in the table below:

PARAMETERS	SYMBOLS	TEST CONDITIONS	APPLICABLE DATA-SHEET			
Ta = 25°C, unless otherwise specified						
			Min	Typ. Value	Max	Unit
Servo Current	I_{p1}	$I_F = 10 \text{ mA}, V_{det} = -15 \text{ V}$		100		µA
Forward Current	I_{p2}	$I_F = 10 \text{ mA}, V_{det} = -15 \text{ V}$		100		µA
Servo Current Gain	K1	$I_F = 10 \text{ mA}, V_{det} = -15 \text{ V}$	0.0085	0.01	0.0115	
Forward Current Gain	K2-1	$I_F = 10 \text{ mA}, V_{det} = -15 \text{ V}$	0.0085	0.01	0.0115	

Results are calculated considering the applicable datasheet [RD1] and the re-evaluated values for the concerned part type.

7 SUMMARY RESULTS

Only parameters with applicable test limits are shown hereunder.

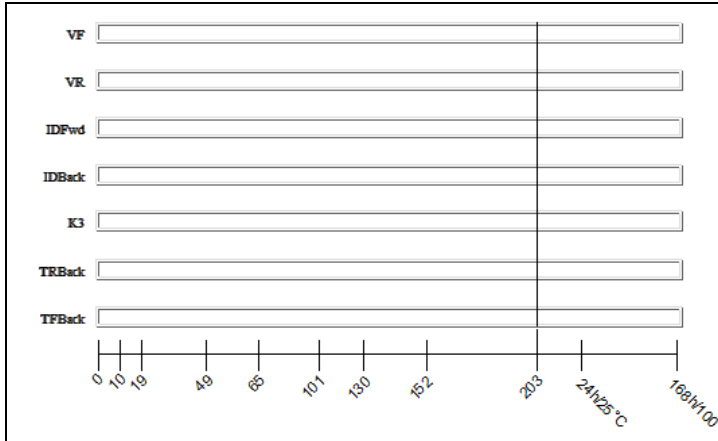

Figure 11: ON Bias 1

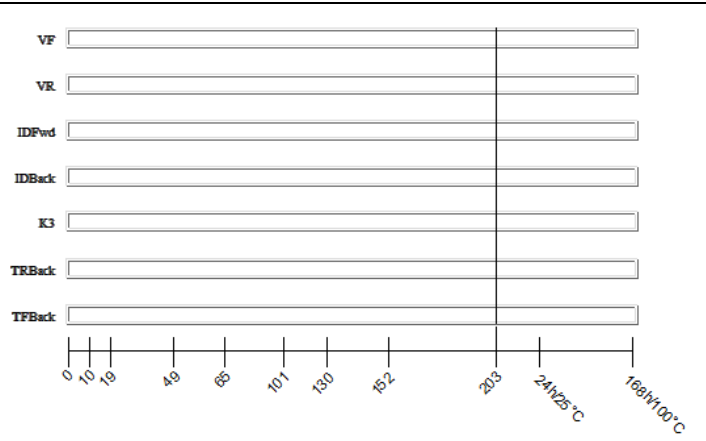

Figure 12: ON Bias 2

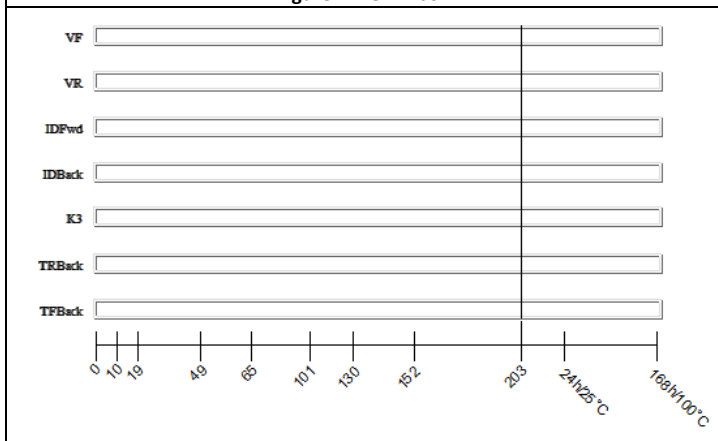

Figure 13 : OFF Bias

- Within specification
- Transition
- Out of specification or parameter not measurable

All defined parameters [RD1] are within the specified values up to 203 kRad(Si).

7.1 K1 and K2_1 case: Considering the applicable datasheet

The table below describes the applicable value mentioned the applicable datasheet [RD1]

PARAMETERS	SYMBOLS	TEST CONDITIONS	APPLICABLE DETAIL DATA-SHEET			
Ta = 25°C, unless otherwise specified						
			Min	Typ. Value	Max	Unit
Servo Current Gain	K1	I _F = 10 mA, V _{det} = -15 V	0.0035	0.005	0.0065	
Forward Current Gain	K2-1	I _F = 10 mA, V _{det} = -15 V	0.0035	0.005	0.0065	

Results are illustrated in the following graphs.

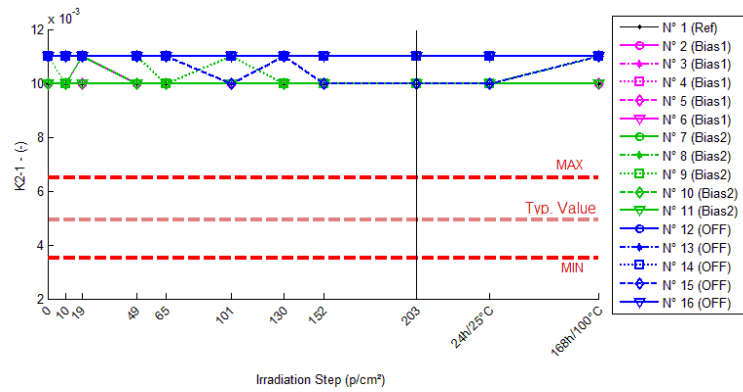
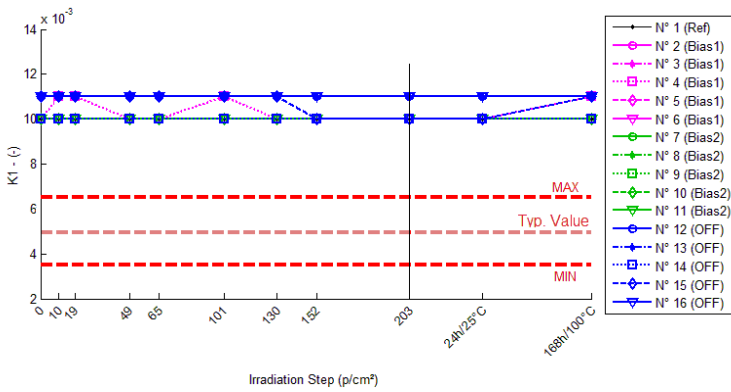

With these conditions (MIN : 0.0035), the evolution of K1 and K2_1 parameter versus accumulated total fluence is registered in the following diagram.

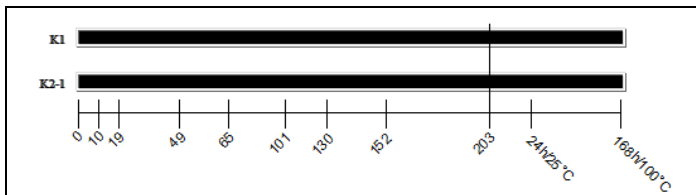

Figure 14: ON Bias 1

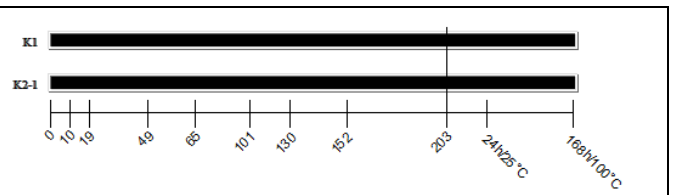

Figure 15: ON Bias 2

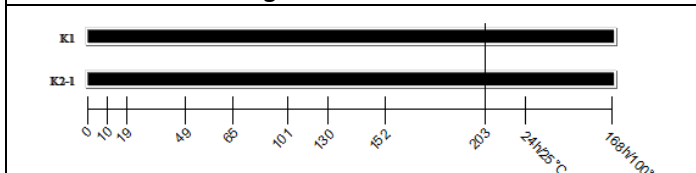
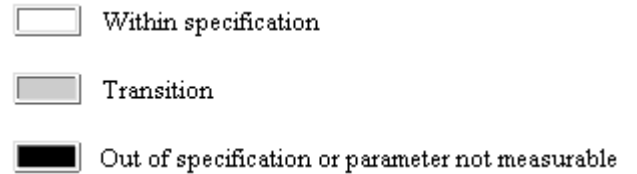

Figure 16: OFF Bias



K1 and K2-1 parameters are out of specification before irradiation.

7.2 K1 and K2_1 case: Considering re-evaluated specification

The table below describes the re-evaluated value:

PARAMETERS	SYMBOLS	TEST CONDITIONS	LIMITS			
Ta = 25°C, unless otherwise specified						
			Min	Typ. Value	Max	Unit
Servo Current Gain	K1	I _F = 10 mA, V _{det} = -15 V	0.0085	0.01	0.0115	
Forward Current Gain	K2-1	I _F = 10 mA, V _{det} = -15 V	0.0085	0.01	0.0115	

Results are illustrated in the following graph:

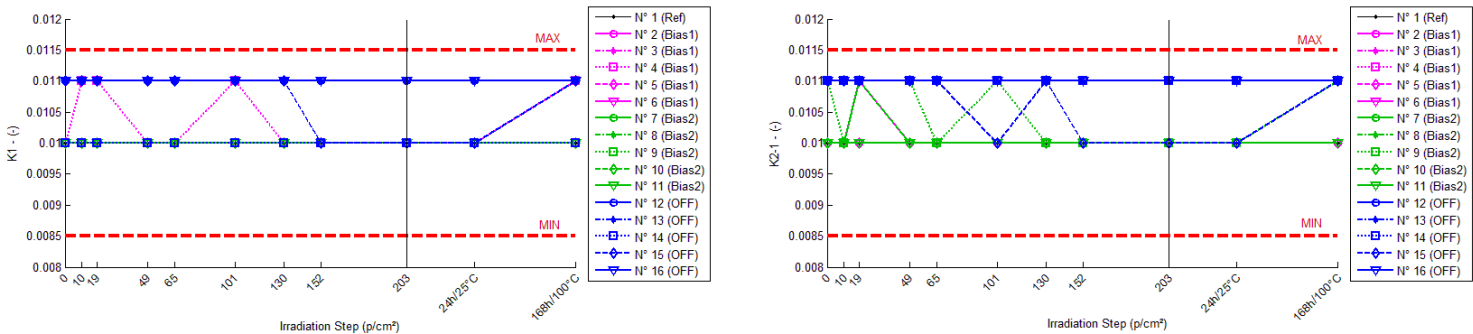

Taking in account these limits (MIN : 0.0085, MAX : 0.0115), the evolution of K1 and K2_1 parameter versus accumulated total dose are registered in the following diagram.

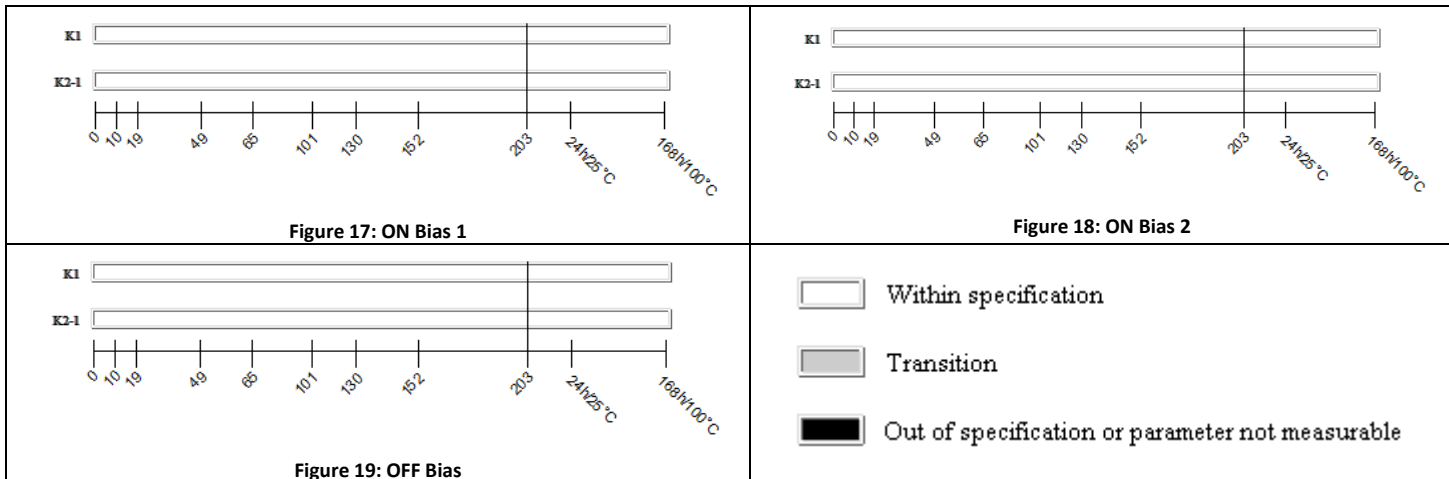

K1 and K2-1 parameters are within the specified values up to 203 kRad(Si).

8 CONCLUSION

Total Ionizing Dose steady-state irradiation test using Gamma ray was performed on on OLH7000.0010 Hermetic Linear Optocoupler from ISOLINK up to 200krad(Si) under three bias conditions.

Final test results are:

- Considering the applicable datasheet [RD1]:
K1 and K2-1 parameters are out of specification before irradiation.

- Considering re-evaluated specification (according to information provided by ISOLINK)
All parameters are within specifications up to total dose level.

9 DETAILED TESTS RESULTS

The pre and post radiation test results are shown graphically in the following pages (9-2 to 9-16). The data is displayed in the following tables and graphs.

These graphs show parameter's shifts observed during the total ionizing dose sequence. The Control sample results are shown on each graph (black curve).

When available in the device data-sheet/specification, the maximum/minimum/typical values are also shown (red dotted line).

The tables include drift calculation between each measurement step and the "0" kRad(Si) step.

For CTR values, the formula used is:

$$\text{Drift} = \frac{1}{\text{measurement (X kRad(Si))}} - \frac{1}{\text{measurement (0 kRad(Si))}}$$

For other parameters, the formula used is:

$$\text{Drift value} = \text{measurement (X kRad(Si))} - \text{measurement (0 kRad(Si))}$$

CONTENTS

1. VF	2
2. VR.....	4
3. IDFwd	6
4. IDback	8
5. VOCFwd.....	10
6. VOBack.....	12
7. Ip1	14
8. K1	16
9. K2-1	18
10. K2-2	20
11. K2-3	22
12. K2-4	24
13. K2-5	26
14. Ip2	28
15. K3	30
16. BWFwd	32
17. BWBack	34
18. TRFwd.....	36
19. TFFwd	38
20. TRBack.....	40
21. TFBack	42

1. VF

Ta = 25°C; IF = 10 mA

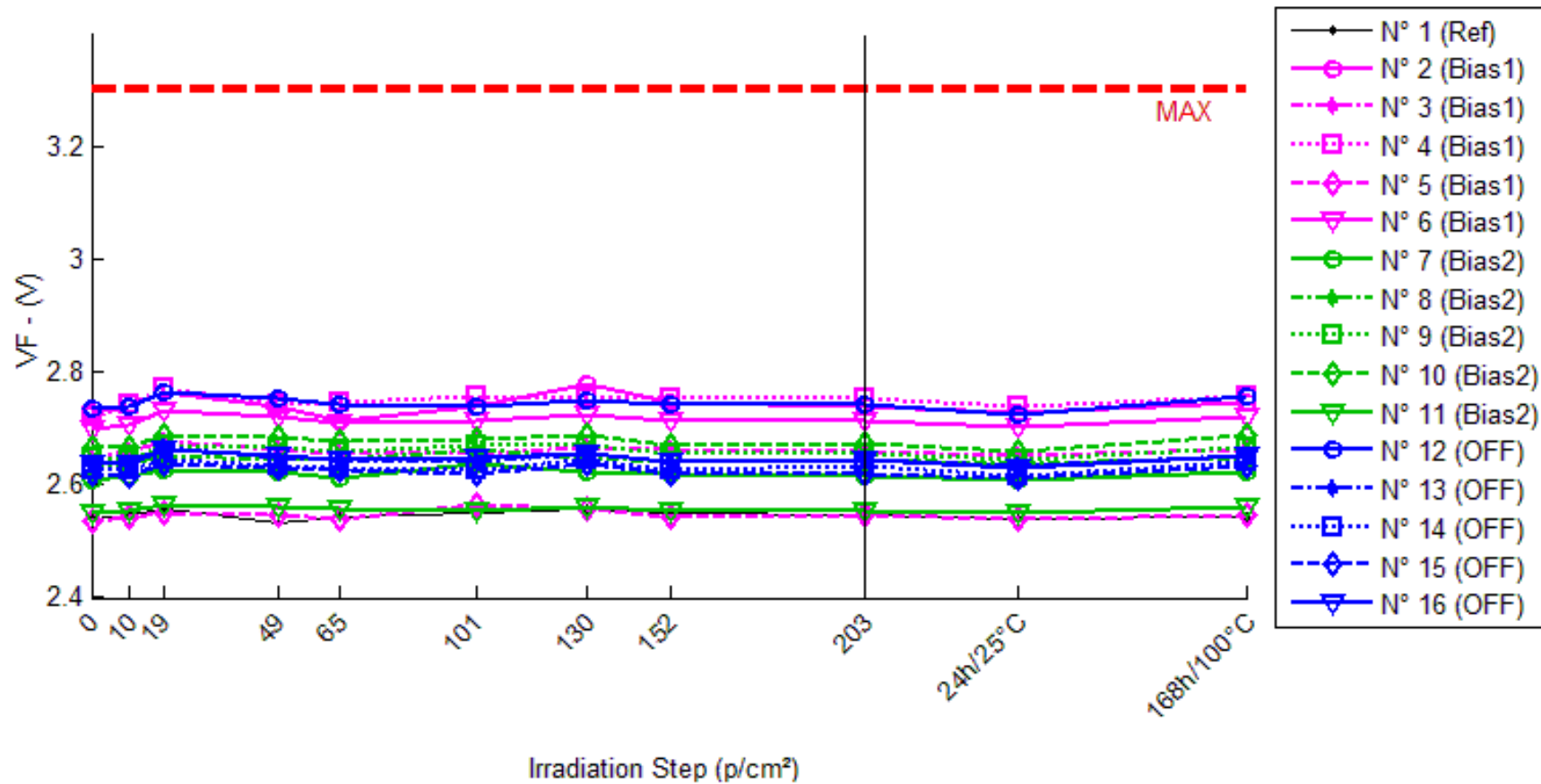

VF . (V)

Max = 3.3

	0krad(Si)	10krad(Si)	19krad(Si)	49krad(Si)	65krad(Si)	101krad(Si)	130krad(Si)	152krad(Si)	203krad(Si)	24h/25°C	168h/100°C
N° 1 (Ref)	2.540	2.545	2.558	2.532	2.542	2.551	2.558	2.550	2.546	2.538	2.543
N° 2 (Bias1)	2.728	2.737	2.764	2.738	2.715	2.739	2.777	2.746	2.739	2.727	2.746
N° 3 (Bias1)	2.649	2.658	2.676	2.662	2.654	2.657	2.668	2.661	2.659	2.651	2.664
N° 4 (Bias1)	2.722	2.744	2.770	2.744	2.747	2.756	2.753	2.753	2.752	2.738	2.756
N° 5 (Bias1)	2.537	2.543	2.551	2.545	2.539	2.564	2.556	2.543	2.545	2.539	2.548
N° 6 (Bias1)	2.700	2.707	2.730	2.721	2.710	2.714	2.723	2.715	2.715	2.703	2.719
N° 7 (Bias2)	2.610	2.615	2.627	2.622	2.613	2.637	2.624	2.618	2.616	2.610	2.624
N° 8 (Bias2)	2.633	2.638	2.653	2.644	2.645	2.663	2.648	2.642	2.644	2.637	2.647
N° 9 (Bias2)	2.647	2.645	2.669	2.665	2.660	2.670	2.669	2.657	2.656	2.646	2.667
N° 10 (Bias2)	2.667	2.666	2.687	2.683	2.676	2.682	2.688	2.671	2.675	2.659	2.688
N° 11 (Bias2)	2.550	2.555	2.564	2.561	2.557	2.555	2.562	2.554	2.555	2.549	2.563
N° 12 (OFF)	2.736	2.737	2.763	2.753	2.743	2.737	2.750	2.741	2.744	2.725	2.757
N° 13 (OFF)	2.636	2.639	2.666	2.649	2.644	2.641	2.655	2.640	2.645	2.633	2.653
N° 14 (OFF)	2.625	2.626	2.646	2.632	2.631	2.627	2.643	2.626	2.632	2.616	2.640
N° 15 (OFF)	2.619	2.617	2.638	2.631	2.627	2.621	2.639	2.621	2.620	2.613	2.633
N° 16 (OFF)	2.638	2.638	2.661	2.652	2.646	2.650	2.656	2.641	2.644	2.631	2.651

Delta [VF]

	0krad(Si)	10krad(Si)	19krad(Si)	49krad(Si)	65krad(Si)	101krad(Si)	130krad(Si)	152krad(Si)	203krad(Si)	24h/25°C	168h/100°C
N° 1 (Ref)	---	4.657E-3	1.751E-2	-8.405E-3	1.996E-3	1.122E-2	1.809E-2	1.019E-2	5.993E-3	-1.985E-3	2.773E-3
N° 2 (Bias1)	---	9.419E-3	3.626E-2	1.007E-2	-1.324E-2	1.083E-2	4.860E-2	1.813E-2	1.113E-2	-9.410E-4	1.819E-2
N° 3 (Bias1)	---	8.548E-3	2.651E-2	1.232E-2	4.588E-3	7.836E-3	1.893E-2	1.160E-2	1.014E-2	1.407E-3	1.483E-2
N° 4 (Bias1)	---	2.192E-2	4.828E-2	2.256E-2	2.567E-2	3.441E-2	3.096E-2	3.091E-2	3.039E-2	1.663E-2	3.424E-2
N° 5 (Bias1)	---	5.854E-3	1.436E-2	8.457E-3	2.424E-3	2.747E-2	1.890E-2	6.366E-3	8.008E-3	2.611E-3	1.089E-2
N° 6 (Bias1)	---	6.475E-3	2.936E-2	2.055E-2	9.965E-3	1.365E-2	2.254E-2	1.483E-2	1.438E-2	2.671E-3	1.910E-2
N° 7 (Bias2)	---	4.669E-3	1.696E-2	1.140E-2	2.467E-3	2.657E-2	1.376E-2	7.885E-3	6.339E-3	8.300E-5	1.368E-2
N° 8 (Bias2)	---	5.604E-3	2.025E-2	1.151E-2	1.247E-2	3.037E-2	1.548E-2	9.490E-3	1.119E-2	4.245E-3	1.477E-2
N° 9 (Bias2)	---	-2.125E-3	2.123E-2	1.781E-2	1.248E-2	2.231E-2	2.136E-2	9.696E-3	8.708E-3	-9.930E-4	1.960E-2
N° 10 (Bias2)	---	-5.410E-4	2.024E-2	1.617E-2	9.747E-3	1.570E-2	2.100E-2	4.910E-3	8.192E-3	-7.042E-3	2.160E-2
N° 11 (Bias2)	---	5.103E-3	1.369E-2	1.085E-2	7.034E-3	4.734E-3	1.161E-2	3.784E-3	5.161E-3	-9.280E-4	1.313E-2
N° 12 (OFF)	---	1.638E-3	2.740E-2	1.746E-2	7.485E-3	1.359E-3	1.410E-2	5.015E-3	7.810E-3	-1.064E-2	2.173E-2
N° 13 (OFF)	---	2.826E-3	2.983E-2	1.314E-2	7.407E-3	4.313E-3	1.854E-2	4.075E-3	8.237E-3	-3.333E-3	1.717E-2
N° 14 (OFF)	---	6.010E-4	2.126E-2	6.622E-3	5.913E-3	2.325E-3	1.777E-2	9.980E-4	7.210E-3	-9.225E-3	1.487E-2
N° 15 (OFF)	---	-2.449E-3	1.866E-2	1.167E-2	7.678E-3	1.535E-3	1.981E-2	1.640E-3	5.700E-4	-6.283E-3	1.395E-2
N° 16 (OFF)	---	-2.980E-4	2.289E-2	1.418E-2	7.316E-3	1.187E-2	1.735E-2	3.056E-3	6.001E-3	-7.392E-3	1.255E-2
Average (Bias1)	---	1.044E-2	3.096E-2	1.479E-2	5.883E-3	1.884E-2	2.798E-2	1.637E-2	1.481E-2	4.475E-3	1.945E-2
σ (Bias1)	---	6.581E-3	1.251E-2	6.365E-3	1.403E-2	1.150E-2	1.253E-2	9.218E-3	9.007E-3	6.950E-3	8.875E-3
Average+3σ (Bias1)	---	3.019E-2	6.848E-2	3.388E-2	4.798E-2	5.334E-2	6.558E-2	4.402E-2	4.183E-2	2.532E-2	4.607E-2
Average-3σ (Bias1)	---	-9.300E-3	-6.573E-3	-4.305E-3	-3.621E-2	-1.566E-2	-9.608E-3	-1.129E-2	-1.221E-2	-1.637E-2	-7.177E-3
Average (Bias2)	---	2.542E-3	1.847E-2	1.355E-2	8.840E-3	1.994E-2	1.664E-2	7.153E-3	7.919E-3	-9.270E-4	1.656E-2
σ (Bias2)	---	3.597E-3	3.124E-3	3.204E-3	4.218E-3	1.009E-2	4.366E-3	2.685E-3	2.320E-3	4.036E-3	3.806E-3
Average+3σ (Bias2)	---	1.333E-2	2.785E-2	2.316E-2	2.149E-2	5.022E-2	2.974E-2	1.521E-2	1.488E-2	1.118E-2	2.797E-2
Average-3σ (Bias2)	---	-8.248E-3	9.100E-3	3.937E-3	-3.813E-3	-1.035E-2	3.545E-3	-9.032E-4	9.594E-4	-1.304E-2	5.138E-3
Average (OFF)	---	4.636E-4	2.401E-2	1.262E-2	7.160E-3	4.279E-3	1.751E-2	2.957E-3	5.966E-3	-7.374E-3	1.605E-2
σ (OFF)	---	2.003E-3	4.548E-3	3.969E-3	7.096E-4	4.400E-3	2.126E-3	1.663E-3	3.131E-3	2.810E-3	3.590E-3
Average+3σ (OFF)	---	6.472E-3	3.765E-2	2.452E-2	2.289E-2	1.748E-2	2.389E-2	7.947E-3	1.536E-2	1.057E-2	2.682E-2
Average-3σ (OFF)	---	-5.544E-3	1.036E-2	7.068E-4	5.031E-3	-8.919E-3	1.113E-2	-2.033E-3	-3.429E-3	-1.581E-2	5.284E-3

2. VR

Ta = 25°C; IR = 100 µA

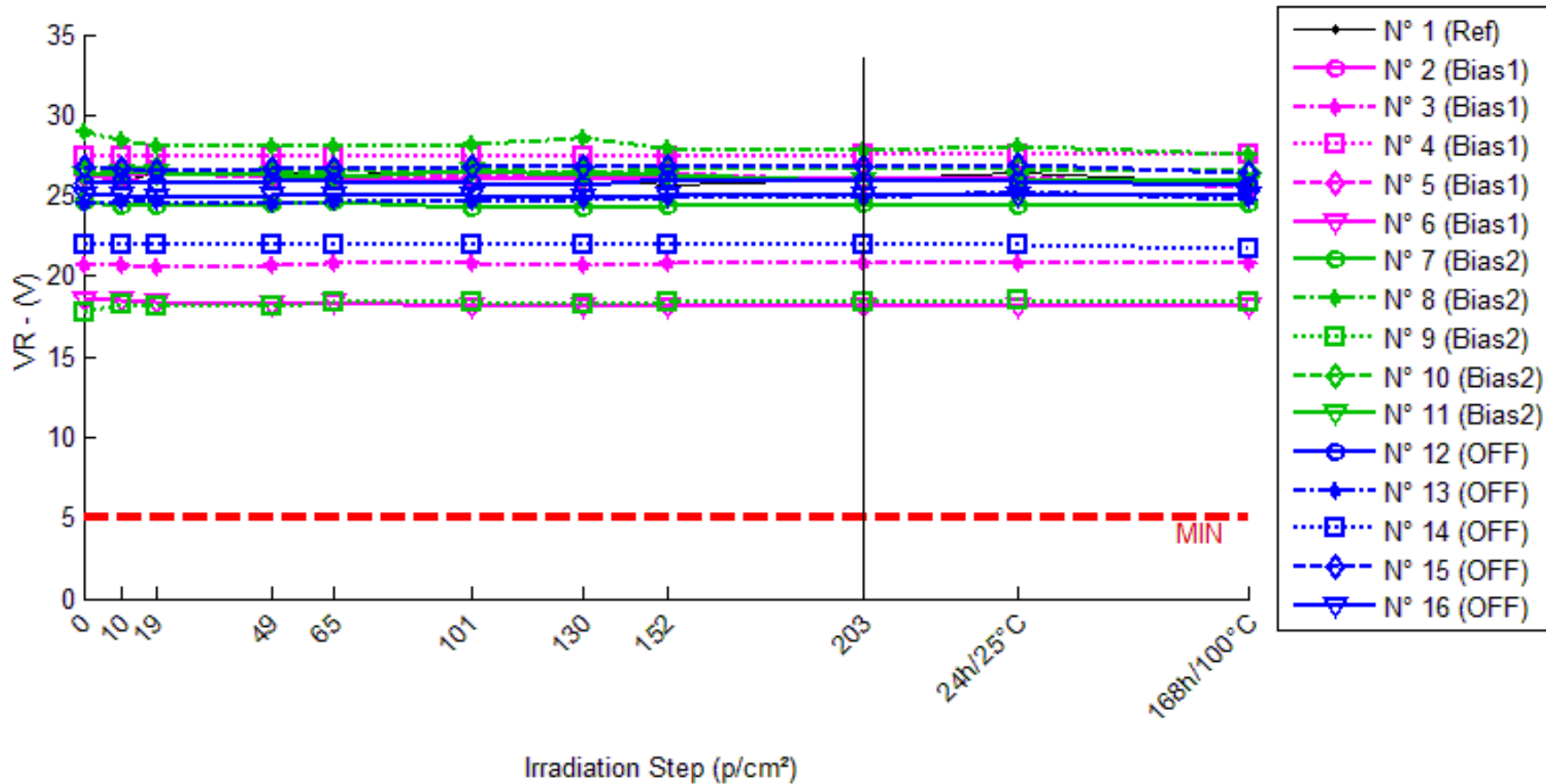

VR . (V) Min = 5.0

	0krad(Si)	10krad(Si)	19krad(Si)	49krad(Si)	65krad(Si)	101krad(Si)	130krad(Si)	152krad(Si)	203krad(Si)	24h/25°C	168h/100°C
N° 1 (Ref)	25.914	25.895	26.386	26.352	26.286	26.566	26.171	25.660	25.994	26.411	25.831
N° 2 (Bias1)	26.233	26.089	25.741	25.876	25.926	26.020	25.964	26.011	26.059	26.089	25.943
N° 3 (Bias1)	20.677	20.669	20.599	20.736	20.802	20.782	20.720	20.781	20.786	20.784	20.859
N° 4 (Bias1)	27.482	27.448	27.533	27.471	27.469	27.497	27.470	27.484	27.496	27.539	27.501
N° 5 (Bias1)	26.237	26.239	26.438	26.140	26.210	26.188	26.568	26.394	25.944	26.120	25.547
N° 6 (Bias1)	18.533	18.487	18.445	18.309	18.345	18.196	18.188	18.168	18.154	18.164	18.097
N° 7 (Bias2)	24.573	24.425	24.379	24.460	24.670	24.259	24.260	24.315	24.506	24.374	24.513
N° 8 (Bias2)	28.905	28.405	28.013	28.107	28.043	28.214	28.561	27.913	27.842	28.013	27.615
N° 9 (Bias2)	17.780	18.231	18.177	18.193	18.386	18.386	18.300	18.334	18.384	18.469	18.453
N° 10 (Bias2)	26.434	26.619	26.691	26.443	26.502	26.663	26.385	26.610	26.807	26.613	26.590
N° 11 (Bias2)	26.309	26.432	26.380	26.267	26.158	26.561	26.228	26.226	25.925	26.017	25.924
N° 12 (OFF)	25.722	25.866	25.802	25.843	25.907	25.754	25.677	25.965	25.863	25.852	25.686
N° 13 (OFF)	24.457	24.565	24.629	24.525	24.642	24.646	24.762	24.831	24.914	25.233	24.741
N° 14 (OFF)	21.953	21.969	21.924	21.955	21.967	21.967	21.933	21.966	21.960	21.992	21.758
N° 15 (OFF)	26.746	26.675	26.568	26.684	26.674	26.802	26.770	26.753	26.788	26.949	26.460
N° 16 (OFF)	25.054	25.002	24.932	24.973	24.987	25.027	24.920	25.007	25.007	25.059	24.992

Delta [VR]

	0krad(Si)	10krad(Si)	19krad(Si)	49krad(Si)	65krad(Si)	101krad(Si)	130krad(Si)	152krad(Si)	203krad(Si)	24h/25°C	168h/100°C
N° 1 (Ref)	---	-1.931E-2	4.716E-1	4.373E-1	3.722E-1	6.515E-1	2.565E-1	-2.540E-1	7.966E-2	4.965E-1	-8.342E-2
N° 2 (Bias1)	---	-1.440E-1	-4.918E-1	-3.577E-1	-3.068E-1	-2.128E-1	-2.690E-1	-2.225E-1	-1.741E-1	-1.443E-1	-2.907E-1
N° 3 (Bias1)	---	-7.470E-3	-7.775E-2	5.972E-2	1.259E-1	1.050E-1	4.368E-2	1.044E-1	1.092E-1	1.073E-1	1.826E-1
N° 4 (Bias1)	---	-3.444E-2	5.031E-2	-1.092E-2	-1.371E-2	1.487E-2	-1.199E-2	1.430E-3	1.333E-2	5.617E-2	1.810E-2
N° 5 (Bias1)	---	1.940E-3	2.016E-1	-9.640E-2	-2.698E-2	-4.851E-2	3.315E-1	1.575E-1	-2.929E-1	-1.166E-1	-6.894E-1
N° 6 (Bias1)	---	-4.580E-2	-8.832E-2	-2.242E-1	-1.882E-1	-3.364E-1	-3.446E-1	-3.651E-1	-3.791E-1	-3.688E-1	-4.357E-1
N° 7 (Bias2)	---	-1.480E-1	-1.940E-1	-1.126E-1	9.711E-2	-3.141E-1	-3.132E-1	-2.581E-1	-6.635E-2	-1.989E-1	-5.928E-2
N° 8 (Bias2)	---	-5.005E-1	-8.924E-1	-7.978E-1	-8.623E-1	-6.912E-1	-3.435E-1	-9.917E-1	-1.063E+0	-8.916E-1	-1.290E+0
N° 9 (Bias2)	---	4.515E-1	3.971E-1	4.134E-1	6.058E-1	6.057E-1	5.204E-1	5.543E-1	6.040E-1	6.887E-1	6.728E-1
N° 10 (Bias2)	---	1.850E-1	2.567E-1	8.870E-3	6.783E-2	2.296E-1	-4.861E-2	1.761E-1	3.731E-1	1.791E-1	1.565E-1
N° 11 (Bias2)	---	1.229E-1	7.138E-2	-4.163E-2	-1.507E-1	2.524E-1	-8.126E-2	-8.265E-2	-3.839E-1	-2.918E-1	-3.853E-1
N° 12 (OFF)	---	1.436E-1	8.043E-2	1.211E-1	1.850E-1	3.237E-2	-4.476E-2	2.432E-1	1.412E-1	1.300E-1	-3.615E-2
N° 13 (OFF)	---	1.079E-1	1.715E-1	6.799E-2	1.842E-1	1.888E-1	3.042E-1	3.738E-1	4.569E-1	7.760E-1	2.836E-1
N° 14 (OFF)	---	1.636E-2	-2.929E-2	1.980E-3	1.382E-2	1.385E-2	-2.023E-2	1.310E-2	7.250E-3	3.899E-2	-1.949E-1
N° 15 (OFF)	---	-7.038E-2	-1.777E-1	-6.116E-2	-7.138E-2	5.659E-2	2.438E-2	6.970E-3	4.223E-2	2.030E-1	-2.859E-1
N° 16 (OFF)	---	-5.200E-2	-1.212E-1	-8.054E-2	-6.630E-2	-2.657E-2	-1.332E-1	-4.680E-2	-4.678E-2	5.290E-3	-6.153E-2
Average (Bias1)	---	-4.596E-2	-8.120E-2	-1.259E-1	-8.197E-2	-9.556E-2	-5.009E-2	-6.486E-2	-1.447E-1	-9.322E-2	-2.430E-1
σ (Bias1)	---	5.815E-2	2.579E-1	1.673E-1	1.679E-1	1.778E-1	2.695E-1	2.222E-1	2.044E-1	1.882E-1	3.493E-1
Average+3σ (Bias1)	---	1.285E-1	6.924E-1	3.760E-1	4.216E-1	4.377E-1	7.584E-1	6.017E-1	4.686E-1	4.713E-1	8.049E-1
Average-3σ (Bias1)	---	-2.204E-1	-8.548E-1	-6.277E-1	-5.856E-1	-6.289E-1	-8.586E-1	-7.314E-1	-7.581E-1	-6.578E-1	-1.291E+0
Average (Bias2)	---	2.219E-2	-7.225E-2	-1.060E-1	-4.845E-2	1.647E-2	-5.324E-2	-1.204E-1	-1.072E-1	-1.029E-1	-1.812E-1
σ (Bias2)	---	3.616E-1	5.090E-1	4.375E-1	5.328E-1	5.144E-1	3.470E-1	5.750E-1	6.573E-1	5.859E-1	7.298E-1
Average+3σ (Bias2)	---	1.107E+0	1.455E+0	1.207E+0	1.550E+0	1.560E+0	9.879E-1	1.605E+0	1.865E+0	1.655E+0	2.008E+0
Average-3σ (Bias2)	---	-1.063E+0	-1.599E+0	-1.418E+0	-1.647E+0	-1.527E+0	-1.094E+0	-1.846E+0	-2.079E+0	-1.861E+0	-2.370E+0
Average (OFF)	---	2.910E-2	-1.525E-2	9.874E-3	4.906E-2	5.301E-2	2.608E-2	1.181E-1	1.202E-1	2.307E-1	-5.897E-2
σ (OFF)	---	9.482E-2	1.430E-1	8.519E-2	1.282E-1	8.177E-2	1.658E-1	1.814E-1	2.004E-1	3.146E-1	2.167E-1
Average+3σ (OFF)	---	3.135E-1	4.138E-1	2.655E-1	4.338E-1	2.983E-1	5.234E-1	6.623E-1	7.212E-1	1.174E+0	5.912E-1
Average-3σ (OFF)	---	-2.553E-1	-4.443E-1	-2.457E-1	-3.357E-1	-1.923E-1	-4.712E-1	-4.261E-1	-4.809E-1	-7.131E-1	-7.092E-1

3. IDFwd

Ta = 25°C; VR = 15 V ; IF = 0

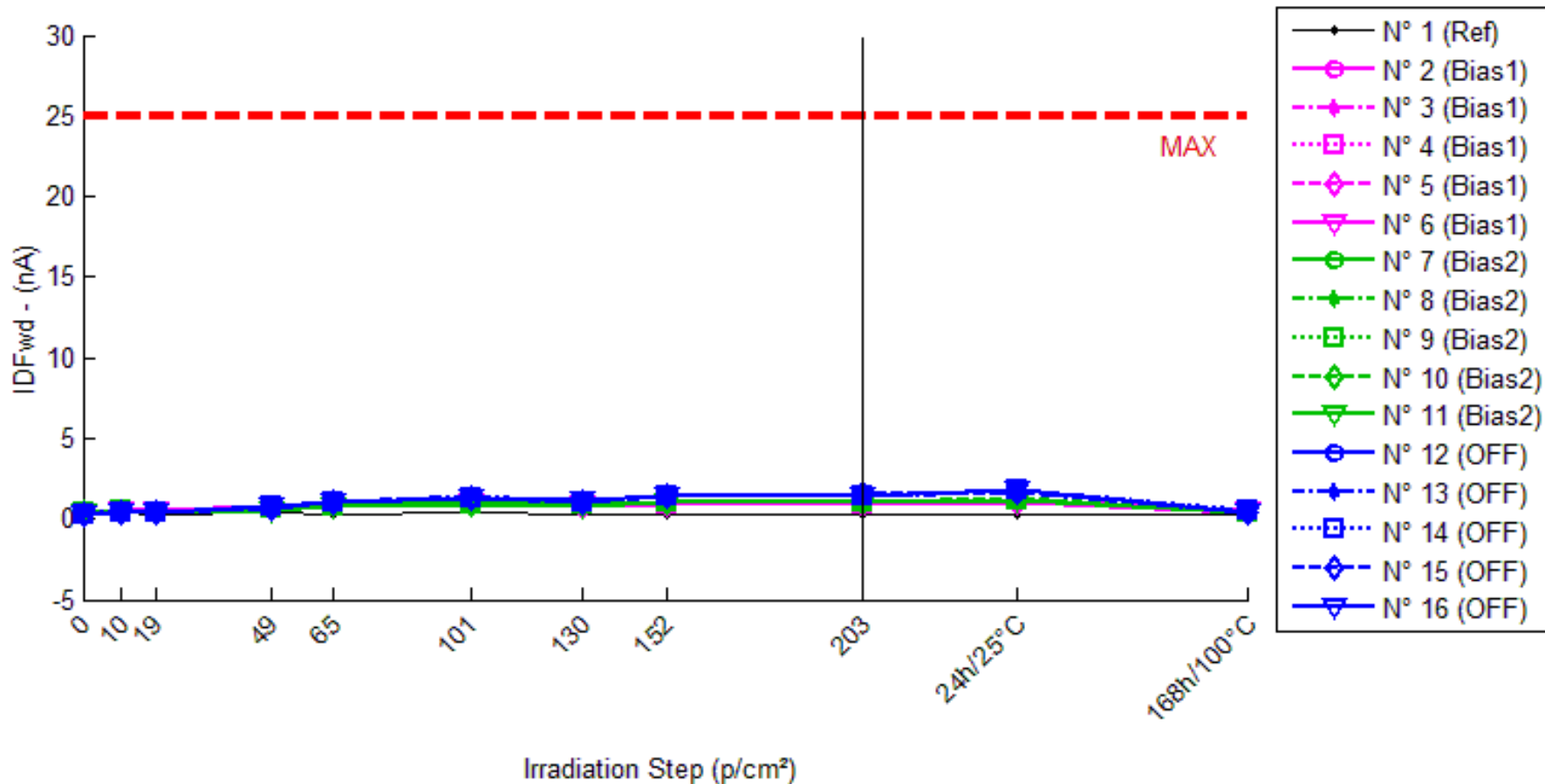

IDFwd . (nA)

Max = 25.0

	0krad(Si)	10krad(Si)	19krad(Si)	49krad(Si)	65krad(Si)	101krad(Si)	130krad(Si)	152krad(Si)	203krad(Si)	24h/25°C	168h/100°C
N° 1 (Ref)	0.445	0.366	0.280	0.348	0.288	0.353	0.226	0.275	0.293	0.329	0.306
N° 2 (Bias1)	0.384	0.493	0.410	0.807	1.039	0.947	0.773	0.864	0.952	1.071	0.449
N° 3 (Bias1)	0.427	0.515	0.470	0.775	0.942	0.939	0.809	0.883	0.942	1.077	0.453
N° 4 (Bias1)	0.346	0.416	0.395	0.744	0.903	0.945	0.869	0.932	0.972	1.110	0.466
N° 5 (Bias1)	0.301	0.400	0.419	0.682	0.964	0.893	0.784	0.939	0.947	1.069	0.453
N° 6 (Bias1)	0.448	0.557	0.518	0.797	1.005	1.086	0.931	1.011	1.041	1.197	0.529
N° 7 (Bias2)	0.326	0.399	0.396	0.630	0.911	0.961	0.856	0.997	1.067	1.190	0.421
N° 8 (Bias2)	0.303	0.363	0.362	0.607	0.801	0.938	0.834	1.010	1.036	1.154	0.410
N° 9 (Bias2)	0.398	0.489	0.452	0.654	0.822	0.978	0.896	1.026	1.083	1.214	0.407
N° 10 (Bias2)	0.383	0.434	0.418	0.650	0.862	0.978	0.873	1.070	1.079	1.259	0.413
N° 11 (Bias2)	0.368	0.404	0.392	0.576	0.749	0.882	0.824	1.001	1.054	1.182	0.399
N° 12 (OFF)	0.345	0.447	0.440	0.765	1.048	1.338	1.234	1.405	1.452	1.782	0.443
N° 13 (OFF)	0.364	0.431	0.416	0.751	1.013	1.440	1.105	1.406	1.401	1.645	0.549
N° 14 (OFF)	0.338	0.427	0.416	0.798	1.000	1.276	1.082	1.413	1.394	1.749	0.482
N° 15 (OFF)	0.265	0.382	0.386	0.708	1.026	1.267	1.069	1.432	1.545	1.710	0.450
N° 16 (OFF)	0.337	0.435	0.429	0.761	1.082	1.292	1.174	1.440	1.473	1.757	0.472

Delta [IDFwd]

	0krad(Si)	10krad(Si)	19krad(Si)	49krad(Si)	65krad(Si)	101krad(Si)	130krad(Si)	152krad(Si)	203krad(Si)	24h/25°C	168h/100°C
N° 1 (Ref)	---	-7.888E-2	-1.647E-1	-9.616E-2	-1.562E-1	-9.199E-2	-2.185E-1	-1.695E-1	-1.514E-1	-1.156E-1	-1.387E-1
N° 2 (Bias1)	---	1.087E-1	2.561E-2	4.227E-1	6.542E-1	5.624E-1	3.887E-1	4.794E-1	5.675E-1	6.865E-1	6.414E-2
N° 3 (Bias1)	---	8.868E-2	4.381E-2	3.487E-1	5.154E-1	5.129E-1	3.823E-1	4.565E-1	5.150E-1	6.507E-1	2.627E-2
N° 4 (Bias1)	---	6.979E-2	4.893E-2	3.982E-1	5.574E-1	5.989E-1	5.233E-1	5.860E-1	6.258E-1	7.640E-1	1.195E-1
N° 5 (Bias1)	---	9.827E-2	1.178E-1	3.802E-1	6.622E-1	5.913E-1	4.828E-1	6.378E-1	6.459E-1	7.676E-1	1.515E-1
N° 6 (Bias1)	---	1.094E-1	7.032E-2	3.491E-1	5.572E-1	6.385E-1	4.833E-1	5.628E-1	5.936E-1	7.496E-1	8.124E-2
N° 7 (Bias2)	---	7.382E-2	7.047E-2	3.043E-1	5.858E-1	6.351E-1	5.307E-1	6.714E-1	7.410E-1	8.649E-1	9.497E-2
N° 8 (Bias2)	---	6.013E-2	5.906E-2	3.045E-1	4.988E-1	6.349E-1	5.317E-1	7.071E-1	7.333E-1	8.513E-1	1.068E-1
N° 9 (Bias2)	---	9.113E-2	5.358E-2	2.560E-1	4.236E-1	5.794E-1	4.980E-1	6.276E-1	6.847E-1	8.161E-1	8.303E-3
N° 10 (Bias2)	---	5.090E-2	3.524E-2	2.677E-1	4.791E-1	5.954E-1	4.899E-1	6.877E-1	6.966E-1	8.763E-1	3.027E-2
N° 11 (Bias2)	---	3.624E-2	2.422E-2	2.079E-1	3.808E-1	5.138E-1	4.560E-1	6.335E-1	6.864E-1	8.146E-1	3.131E-2
N° 12 (OFF)	---	1.018E-1	9.532E-2	4.199E-1	7.033E-1	9.932E-1	8.893E-1	1.060E+0	1.107E+0	1.437E+0	9.758E-2
N° 13 (OFF)	---	6.707E-2	5.120E-2	3.862E-1	6.485E-1	1.076E+0	7.407E-1	1.041E+0	1.037E+0	1.281E+0	1.845E-1
N° 14 (OFF)	---	8.864E-2	7.826E-2	4.597E-1	6.615E-1	9.383E-1	7.435E-1	1.075E+0	1.056E+0	1.411E+0	1.437E-1
N° 15 (OFF)	---	1.166E-1	1.210E-1	4.430E-1	7.611E-1	1.002E+0	8.035E-1	1.166E+0	1.279E+0	1.444E+0	1.843E-1
N° 16 (OFF)	---	9.773E-2	9.167E-2	4.237E-1	7.452E-1	9.547E-1	8.371E-1	1.103E+0	1.136E+0	1.420E+0	1.350E-1
Average (Bias1)	---	9.497E-2	6.129E-2	3.798E-1	5.893E-1	5.808E-1	4.521E-1	5.445E-1	5.896E-1	7.237E-1	8.853E-2
σ (Bias1)	---	1.644E-2	3.538E-2	3.198E-2	6.527E-2	4.666E-2	6.301E-2	7.539E-2	5.136E-2	5.231E-2	4.860E-2
Average+3σ (Bias1)	---	1.443E-1	1.674E-1	4.757E-1	7.851E-1	7.208E-1	6.411E-1	7.707E-1	7.436E-1	8.806E-1	2.343E-1
Average-3σ (Bias1)	---	4.564E-2	-4.484E-2	2.839E-1	3.934E-1	4.408E-1	2.630E-1	3.183E-1	4.355E-1	5.667E-1	-5.728E-2
Average (Bias2)	---	6.244E-2	4.851E-2	2.681E-1	4.736E-1	5.917E-1	5.013E-1	6.655E-1	7.084E-1	8.446E-1	5.433E-2
σ (Bias2)	---	2.108E-2	1.861E-2	4.004E-2	7.804E-2	4.994E-2	3.155E-2	3.434E-2	2.678E-2	2.816E-2	4.369E-2
Average+3σ (Bias2)	---	1.257E-1	1.043E-1	3.882E-1	7.077E-1	7.416E-1	5.959E-1	7.685E-1	7.887E-1	9.291E-1	1.854E-1
Average-3σ (Bias2)	---	-8.006E-4	-7.311E-3	1.480E-1	2.395E-1	4.419E-1	4.066E-1	5.624E-1	6.281E-1	7.602E-1	-7.673E-2
Average (OFF)	---	9.436E-2	8.750E-2	4.265E-1	7.039E-1	9.928E-1	8.028E-1	1.089E+0	1.123E+0	1.399E+0	1.490E-1
σ (OFF)	---	1.829E-2	2.553E-2	2.764E-2	4.960E-2	5.335E-2	6.332E-2	4.874E-2	9.583E-2	6.723E-2	3.666E-2
Average+3σ (OFF)	---	1.492E-1	1.641E-1	5.094E-1	8.527E-1	1.153E+0	9.928E-1	1.235E+0	1.410E+0	1.600E+0	2.590E-1
Average-3σ (OFF)	---	3.947E-2	1.092E-2	3.436E-1	5.551E-1	8.327E-1	6.129E-1	9.427E-1	8.354E-1	1.197E+0	3.904E-2

4. IDback

Ta = 25°C; VR = 15 V ; IF = 0

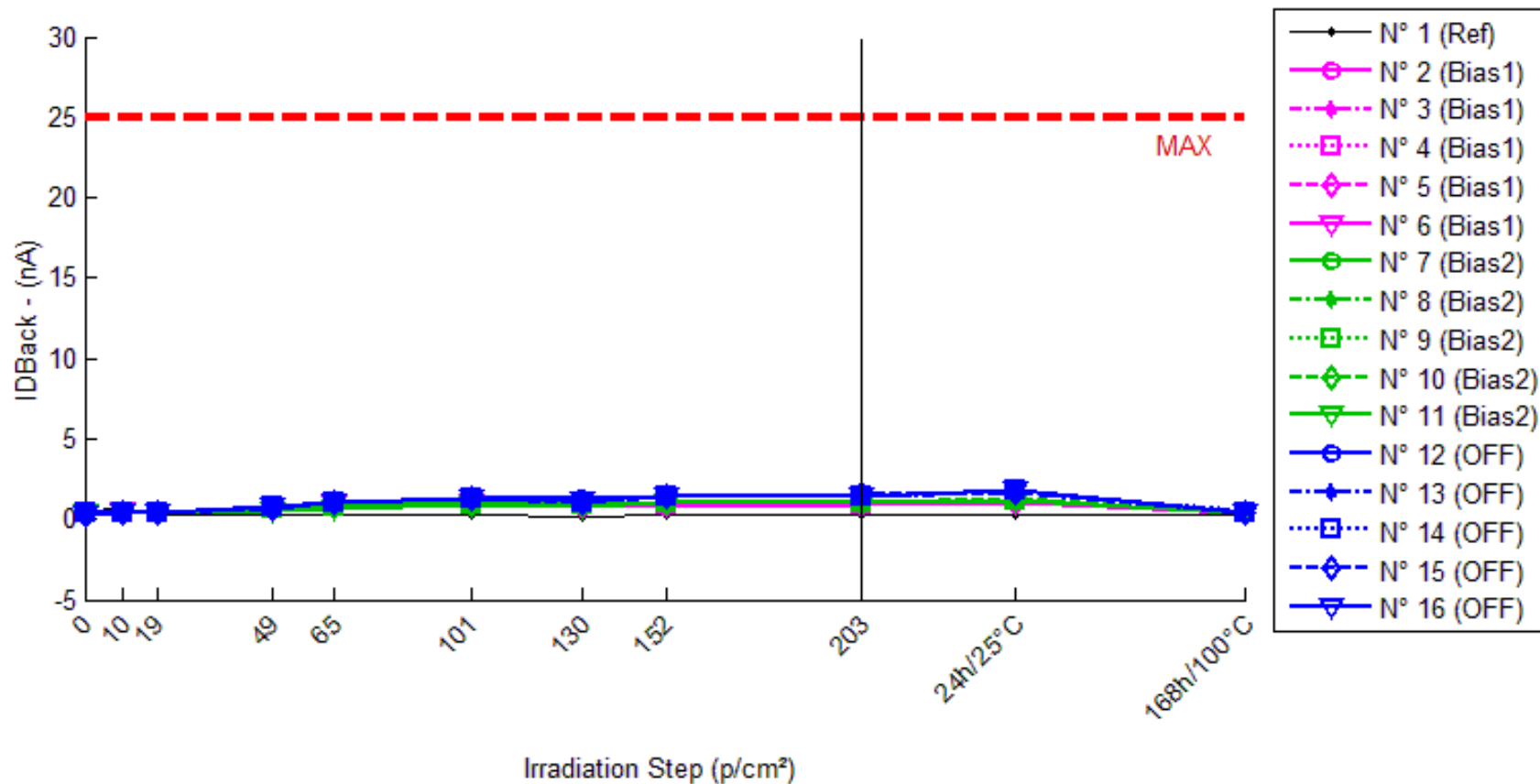

IDBack . (nA) Max = 25.0

	0krad(Si)	10krad(Si)	19krad(Si)	49krad(Si)	65krad(Si)	101krad(Si)	130krad(Si)	152krad(Si)	203krad(Si)	24h/25°C	168h/100°C
N° 1 (Ref)	0.493	0.604	0.230	0.320	0.271	0.304	0.207	0.240	0.260	0.289	0.265
N° 2 (Bias1)	0.453	0.582	0.398	0.790	1.029	0.927	0.757	0.840	0.929	1.046	0.414
N° 3 (Bias1)	0.445	0.530	0.437	0.752	0.913	0.921	0.791	0.865	0.927	1.065	0.428
N° 4 (Bias1)	0.388	0.464	0.401	0.781	0.907	0.988	0.907	0.930	0.966	1.111	0.446
N° 5 (Bias1)	0.335	0.438	0.418	0.706	0.946	0.907	0.800	0.922	0.936	1.061	0.427
N° 6 (Bias1)	0.389	0.499	0.461	0.741	0.942	1.034	0.884	0.958	0.992	1.139	0.469
N° 7 (Bias2)	0.333	0.408	0.395	0.637	0.890	0.973	0.870	0.989	1.060	1.183	0.393
N° 8 (Bias2)	0.316	0.389	0.367	0.627	0.792	0.979	0.870	1.011	1.031	1.164	0.388
N° 9 (Bias2)	0.372	0.458	0.422	0.638	0.807	0.969	0.883	1.013	1.067	1.203	0.382
N° 10 (Bias2)	0.341	0.413	0.406	0.634	0.819	0.970	0.865	1.046	1.045	1.254	0.383
N° 11 (Bias2)	0.351	0.394	0.381	0.572	0.727	0.887	0.832	1.000	1.052	1.185	0.369
N° 12 (OFF)	0.346	0.440	0.431	0.767	1.040	1.359	1.253	1.412	1.456	1.798	0.417
N° 13 (OFF)	0.344	0.425	0.407	0.754	0.999	1.304	1.123	1.412	1.409	1.659	0.489
N° 14 (OFF)	0.390	0.435	0.414	0.802	0.993	1.289	1.095	1.414	1.391	1.756	0.429
N° 15 (OFF)	0.291	0.411	0.388	0.716	0.995	1.283	1.071	1.392	1.516	1.688	0.415
N° 16 (OFF)	0.323	0.429	0.420	0.765	1.064	1.295	1.180	1.426	1.468	1.755	0.446

Delta [IDBack]

	0krad(Si)	10krad(Si)	19krad(Si)	49krad(Si)	65krad(Si)	101krad(Si)	130krad(Si)	152krad(Si)	203krad(Si)	24h/25°C	168h/100°C
N° 1 (Ref)	---	1.106E-1	-2.628E-1	-1.728E-1	-2.224E-1	-1.892E-1	-2.857E-1	-2.525E-1	-2.332E-1	-2.036E-1	-2.275E-1
N° 2 (Bias1)	---	1.289E-1	-5.447E-2	3.373E-1	5.760E-1	4.741E-1	3.042E-1	3.867E-1	4.761E-1	5.930E-1	-3.881E-2
N° 3 (Bias1)	---	8.414E-2	-8.557E-3	3.062E-1	4.674E-1	4.755E-1	3.451E-1	4.199E-1	4.812E-1	6.191E-1	-1.789E-2
N° 4 (Bias1)	---	7.543E-2	1.297E-2	3.930E-1	5.191E-1	5.999E-1	5.190E-1	5.419E-1	5.778E-1	7.227E-1	5.717E-2
N° 5 (Bias1)	---	1.023E-1	8.262E-2	3.707E-1	6.113E-1	5.715E-1	4.647E-1	5.872E-1	6.007E-1	7.257E-1	9.194E-2
N° 6 (Bias1)	---	1.095E-1	7.196E-2	3.512E-1	5.522E-1	6.446E-1	4.946E-1	5.689E-1	6.025E-1	7.498E-1	7.933E-2
N° 7 (Bias2)	---	7.548E-2	6.185E-2	3.046E-1	5.570E-1	6.405E-1	5.371E-1	6.557E-1	7.269E-1	8.505E-1	6.009E-2
N° 8 (Bias2)	---	7.283E-2	5.096E-2	3.107E-1	4.752E-1	6.627E-1	5.537E-1	6.943E-1	7.143E-1	8.473E-1	7.136E-2
N° 9 (Bias2)	---	8.585E-2	4.990E-2	2.655E-1	4.353E-1	5.965E-1	5.105E-1	6.410E-1	6.944E-1	8.311E-1	9.533E-3
N° 10 (Bias2)	---	7.181E-2	6.474E-2	2.923E-1	4.776E-1	6.289E-1	5.242E-1	7.049E-1	7.036E-1	9.130E-1	4.201E-2
N° 11 (Bias2)	---	4.282E-2	2.995E-2	2.203E-1	3.757E-1	5.356E-1	4.805E-1	6.486E-1	7.004E-1	8.332E-1	1.758E-2
N° 12 (OFF)	---	9.393E-2	8.517E-2	4.215E-1	6.945E-1	1.013E+0	9.075E-1	1.067E+0	1.111E+0	1.452E+0	7.140E-2
N° 13 (OFF)	---	8.112E-2	6.301E-2	4.097E-1	6.555E-1	9.603E-1	7.788E-1	1.068E+0	1.065E+0	1.315E+0	1.453E-1
N° 14 (OFF)	---	4.478E-2	2.417E-2	4.118E-1	6.030E-1	8.990E-1	7.051E-1	1.024E+0	1.001E+0	1.366E+0	3.929E-2
N° 15 (OFF)	---	1.197E-1	9.680E-2	4.250E-1	7.039E-1	9.919E-1	7.800E-1	1.101E+0	1.225E+0	1.397E+0	1.238E-1
N° 16 (OFF)	---	1.062E-1	9.727E-2	4.420E-1	7.412E-1	9.721E-1	8.572E-1	1.103E+0	1.145E+0	1.432E+0	1.231E-1
Average (Bias1)	---	1.001E-1	2.090E-2	3.517E-1	5.452E-1	5.531E-1	4.255E-1	5.009E-1	5.477E-1	6.821E-1	3.435E-2
σ (Bias1)	---	2.114E-2	5.707E-2	3.296E-2	5.500E-2	7.611E-2	9.516E-2	9.131E-2	6.375E-2	7.076E-2	5.904E-2
Average+3σ (Bias1)	---	1.635E-1	1.921E-1	4.505E-1	7.102E-1	7.815E-1	7.110E-1	7.748E-1	7.389E-1	8.943E-1	2.115E-1
Average-3σ (Bias1)	---	3.665E-2	-1.503E-1	2.528E-1	3.802E-1	3.248E-1	1.400E-1	2.270E-1	3.564E-1	4.698E-1	-1.428E-1
Average (Bias2)	---	6.976E-2	5.148E-2	2.787E-1	4.642E-1	6.128E-1	5.212E-1	6.689E-1	7.079E-1	8.550E-1	4.012E-2
σ (Bias2)	---	1.606E-2	1.369E-2	3.695E-2	6.630E-2	4.936E-2	2.780E-2	2.875E-2	1.283E-2	3.350E-2	2.656E-2
Average+3σ (Bias2)	---	1.179E-1	9.255E-2	3.895E-1	6.631E-1	7.609E-1	6.046E-1	7.551E-1	7.464E-1	9.555E-1	1.198E-1
Average-3σ (Bias2)	---	2.159E-2	1.041E-2	1.679E-1	2.653E-1	4.647E-1	4.378E-1	5.827E-1	6.694E-1	7.545E-1	-3.957E-2
Average (OFF)	---	8.914E-2	7.328E-2	4.220E-1	6.796E-1	9.673E-1	8.057E-1	1.073E+0	1.109E+0	1.392E+0	1.006E-1
σ (OFF)	---	2.863E-2	3.077E-2	1.290E-2	5.256E-2	4.315E-2	7.827E-2	3.204E-2	8.410E-2	5.450E-2	4.374E-2
Average+3σ (OFF)	---	1.750E-1	1.656E-1	4.607E-1	8.373E-1	1.097E+0	1.041E+0	1.169E+0	1.362E+0	1.556E+0	2.318E-1
Average-3σ (OFF)	---	3.246E-3	-1.903E-2	3.833E-1	5.220E-1	8.378E-1	5.709E-1	9.764E-1	8.571E-1	1.229E+0	-3.065E-2

5. VOCFwd

Ta = 25°C; IF = 10 mA

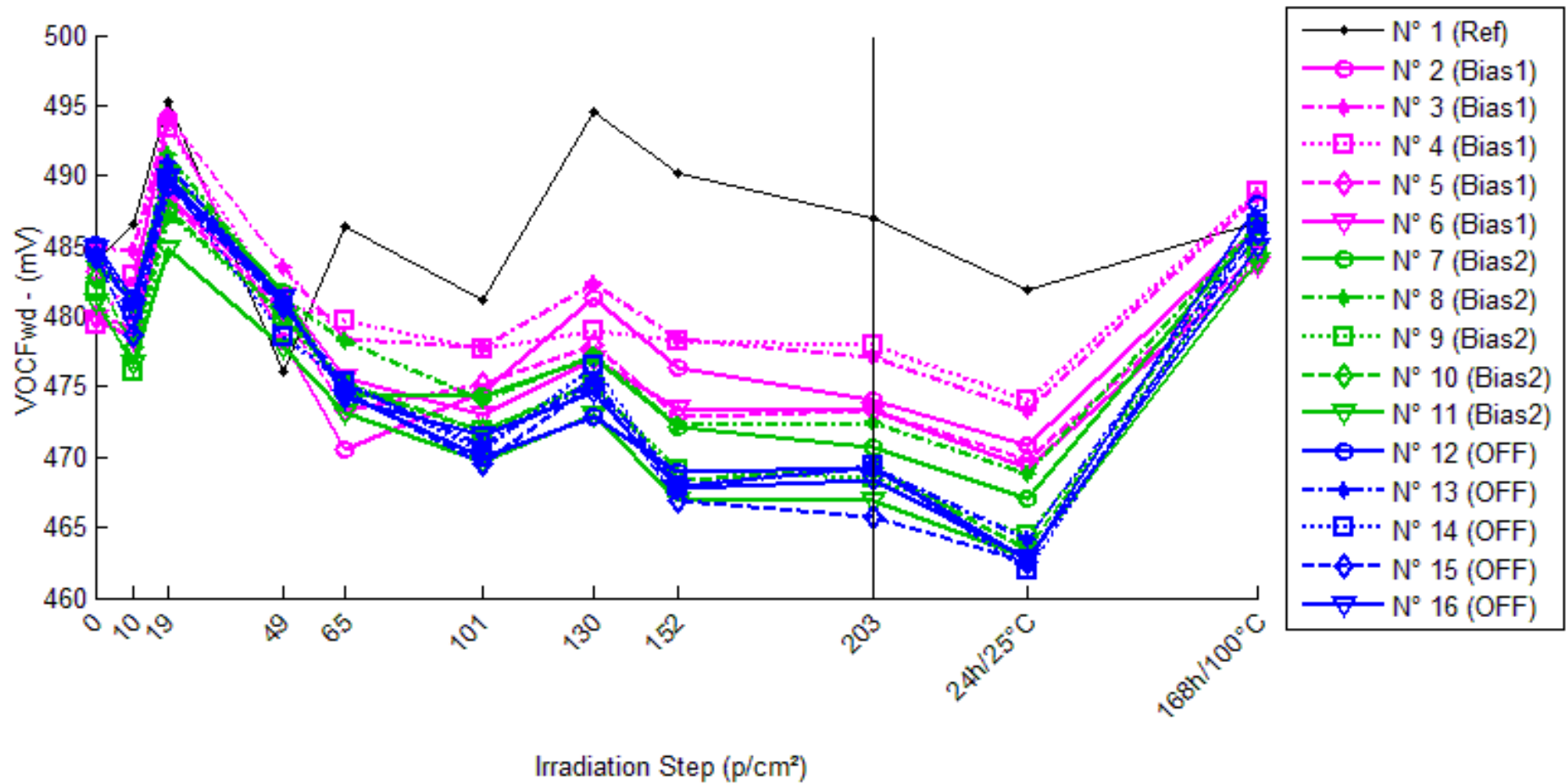

VOCFwd . (mV)

	0krad(Si)	10krad(Si)	19krad(Si)	49krad(Si)	65krad(Si)	101krad(Si)	130krad(Si)	152krad(Si)	203krad(Si)	24h/25°C	168h/100°C
N° 1 (Ref)	483.889	486.489	495.242	476.013	486.359	481.187	494.572	490.226	486.985	481.942	486.726
N° 2 (Bias1)	483.236	482.127	494.166	478.226	470.559	474.568	481.356	476.433	474.100	470.866	486.375
N° 3 (Bias1)	484.963	484.711	494.236	483.442	478.357	477.865	482.372	478.383	477.084	473.305	488.569
N° 4 (Bias1)	479.422	482.958	493.402	480.914	479.757	477.601	479.014	478.322	477.915	474.064	488.898
N° 5 (Bias1)	480.031	479.322	488.275	480.356	473.312	475.244	477.931	472.890	473.303	469.876	484.317
N° 6 (Bias1)	479.842	478.350	488.388	481.439	475.589	473.082	476.920	473.395	473.290	469.255	483.578
N° 7 (Bias2)	483.907	480.918	490.504	481.739	474.426	474.318	477.062	472.133	470.756	467.027	486.444
N° 8 (Bias2)	484.177	480.999	491.542	481.238	478.221	474.017	477.183	472.321	472.468	468.818	486.496
N° 9 (Bias2)	481.750	476.043	487.269	479.973	474.856	471.925	475.046	469.088	468.580	464.488	484.524
N° 10 (Bias2)	482.779	477.880	487.499	480.153	475.141	471.841	475.347	468.324	469.195	463.390	486.662
N° 11 (Bias2)	480.969	476.595	484.859	477.759	473.111	469.605	473.067	466.959	466.894	462.851	483.860
N° 12 (OFF)	485.066	481.349	489.812	481.013	474.472	469.981	472.873	468.875	469.173	462.642	487.976
N° 13 (OFF)	483.872	480.875	490.912	480.774	475.165	470.897	475.557	467.935	469.263	464.122	486.603
N° 14 (OFF)	484.828	480.434	489.712	478.607	475.384	470.453	476.442	467.914	469.371	461.938	486.525
N° 15 (OFF)	484.173	478.744	489.249	480.700	474.689	469.518	475.268	466.928	465.818	462.544	485.916
N° 16 (OFF)	484.764	480.575	489.961	481.341	474.196	471.592	474.621	467.778	468.429	462.791	484.877

Delta [VOCFwd]

	0krad(Si)	10krad(Si)	19krad(Si)	49krad(Si)	65krad(Si)	101krad(Si)	130krad(Si)	152krad(Si)	203krad(Si)	24h/25°C	168h/100°C
N° 1 (Ref)	---	2.600E+0	1.135E+1	-7.876E+0	2.470E+0	-2.702E+0	1.068E+1	6.337E+0	3.096E+0	-1.947E+0	2.837E+0
N° 2 (Bias1)	---	-1.109E+0	1.093E+1	-5.010E+0	-1.268E+1	-8.668E+0	-1.880E+0	-6.802E+0	-9.136E+0	-1.237E+1	3.139E+0
N° 3 (Bias1)	---	-2.515E-1	9.273E+0	-1.520E+0	-6.605E+0	-7.098E+0	-2.590E+0	-6.580E+0	-7.879E+0	-1.166E+1	3.606E+0
N° 4 (Bias1)	---	3.536E+0	1.398E+1	1.492E+0	3.353E-1	-1.820E+0	-4.078E-1	-1.099E+0	-1.507E+0	-5.357E+0	9.476E+0
N° 5 (Bias1)	---	-7.083E-1	8.244E+0	3.251E-1	-6.718E+0	-4.786E+0	-2.099E+0	-7.141E+0	-6.728E+0	-1.015E+1	4.287E+0
N° 6 (Bias1)	---	-1.493E+0	8.546E+0	1.597E+0	-4.253E+0	-6.761E+0	-2.923E+0	-6.448E+0	-6.552E+0	-1.059E+1	3.736E+0
N° 7 (Bias2)	---	-2.989E+0	6.597E+0	-2.168E+0	-9.482E+0	-9.589E+0	-6.845E+0	-1.177E+1	-1.315E+1	-1.688E+1	2.537E+0
N° 8 (Bias2)	---	-3.177E+0	7.365E+0	-2.939E+0	-5.955E+0	-1.016E+1	-6.993E+0	-1.186E+1	-1.171E+1	-1.536E+1	2.319E+0
N° 9 (Bias2)	---	-5.708E+0	5.518E+0	-1.778E+0	-6.894E+0	-9.826E+0	-6.704E+0	-1.266E+1	-1.317E+1	-1.726E+1	2.773E+0
N° 10 (Bias2)	---	-4.899E+0	4.719E+0	-2.626E+0	-7.638E+0	-1.094E+1	-7.432E+0	-1.446E+1	-1.358E+1	-1.939E+1	3.882E+0
N° 11 (Bias2)	---	-4.374E+0	3.890E+0	-3.209E+0	-7.858E+0	-1.136E+1	-7.901E+0	-1.401E+1	-1.407E+1	-1.812E+1	2.891E+0
N° 12 (OFF)	---	-3.717E+0	4.746E+0	-4.053E+0	-1.059E+1	-1.509E+1	-1.219E+1	-1.619E+1	-1.589E+1	-2.242E+1	2.910E+0
N° 13 (OFF)	---	-2.997E+0	7.041E+0	-3.097E+0	-8.706E+0	-1.297E+1	-8.315E+0	-1.594E+1	-1.461E+1	-1.975E+1	2.731E+0
N° 14 (OFF)	---	-4.394E+0	4.884E+0	-6.222E+0	-9.444E+0	-1.438E+1	-8.386E+0	-1.691E+1	-1.546E+1	-2.289E+1	1.697E+0
N° 15 (OFF)	---	-5.429E+0	5.076E+0	-3.473E+0	-9.484E+0	-1.466E+1	-8.905E+0	-1.725E+1	-1.836E+1	-2.163E+1	1.743E+0
N° 16 (OFF)	---	-4.189E+0	5.197E+0	-3.423E+0	-1.057E+1	-1.317E+1	-1.014E+1	-1.699E+1	-1.634E+1	-2.197E+1	1.125E-1
Average (Bias1)	---	-4.960E-3	1.019E+1	-6.231E-1	-5.984E+0	-5.827E+0	-1.980E+0	-5.614E+0	-6.360E+0	-1.003E+1	4.849E+0
σ (Bias1)	---	2.033E+0	2.358E+0	2.755E+0	4.708E+0	2.631E+0	9.691E-1	2.537E+0	2.904E+0	2.752E+0	2.619E+0
Average+3σ (Bias1)	---	6.093E+0	1.727E+1	7.640E+0	8.139E+0	2.067E+0	9.274E-1	1.998E+0	2.352E+0	-1.771E+0	1.271E+1
Average-3σ (Bias1)	---	-6.103E+0	3.120E+0	-8.887E+0	-2.011E+1	-1.372E+1	-4.887E+0	-1.323E+1	-1.507E+1	-1.828E+1	-3.008E+0
Average (Bias2)	---	-4.229E+0	5.618E+0	-2.544E+0	-7.565E+0	-1.038E+1	-7.175E+0	-1.295E+1	-1.314E+1	-1.740E+1	2.881E+0
σ (Bias2)	---	1.151E+0	1.398E+0	5.774E-1	1.304E+0	7.518E-1	4.891E-1	1.230E+0	8.834E-1	1.494E+0	6.017E-1
Average+3σ (Bias2)	---	-7.764E-1	9.811E+0	-8.117E-1	-3.652E+0	-8.120E+0	-5.708E+0	-9.261E+0	-1.049E+1	-1.292E+1	4.686E+0
Average-3σ (Bias2)	---	-7.682E+0	1.425E+0	-4.276E+0	-1.148E+1	-1.263E+1	-8.643E+0	-1.664E+1	-1.579E+1	-2.188E+1	1.076E+0
Average (OFF)	---	-4.145E+0	5.389E+0	-4.054E+0	-9.759E+0	-1.405E+1	-9.589E+0	-1.665E+1	-1.613E+1	-2.173E+1	1.839E+0
σ (OFF)	---	8.963E-1	9.395E-1	1.260E+0	8.117E-1	9.315E-1	1.630E+0	5.606E-1	1.398E+0	1.206E+0	1.113E+0
Average+3σ (OFF)	---	-1.456E+0	8.207E+0	-2.736E-1	-7.324E+0	-1.126E+1	-4.699E+0	-1.497E+1	-1.194E+1	-1.811E+1	5.177E+0
Average-3σ (OFF)	---	-6.834E+0	2.570E+0	-7.834E+0	-1.219E+1	-1.685E+1	-1.448E+1	-1.834E+1	-2.032E+1	-2.535E+1	-1.499E+0

6. VOCBack

Ta = 25°C; IF = 10 mA

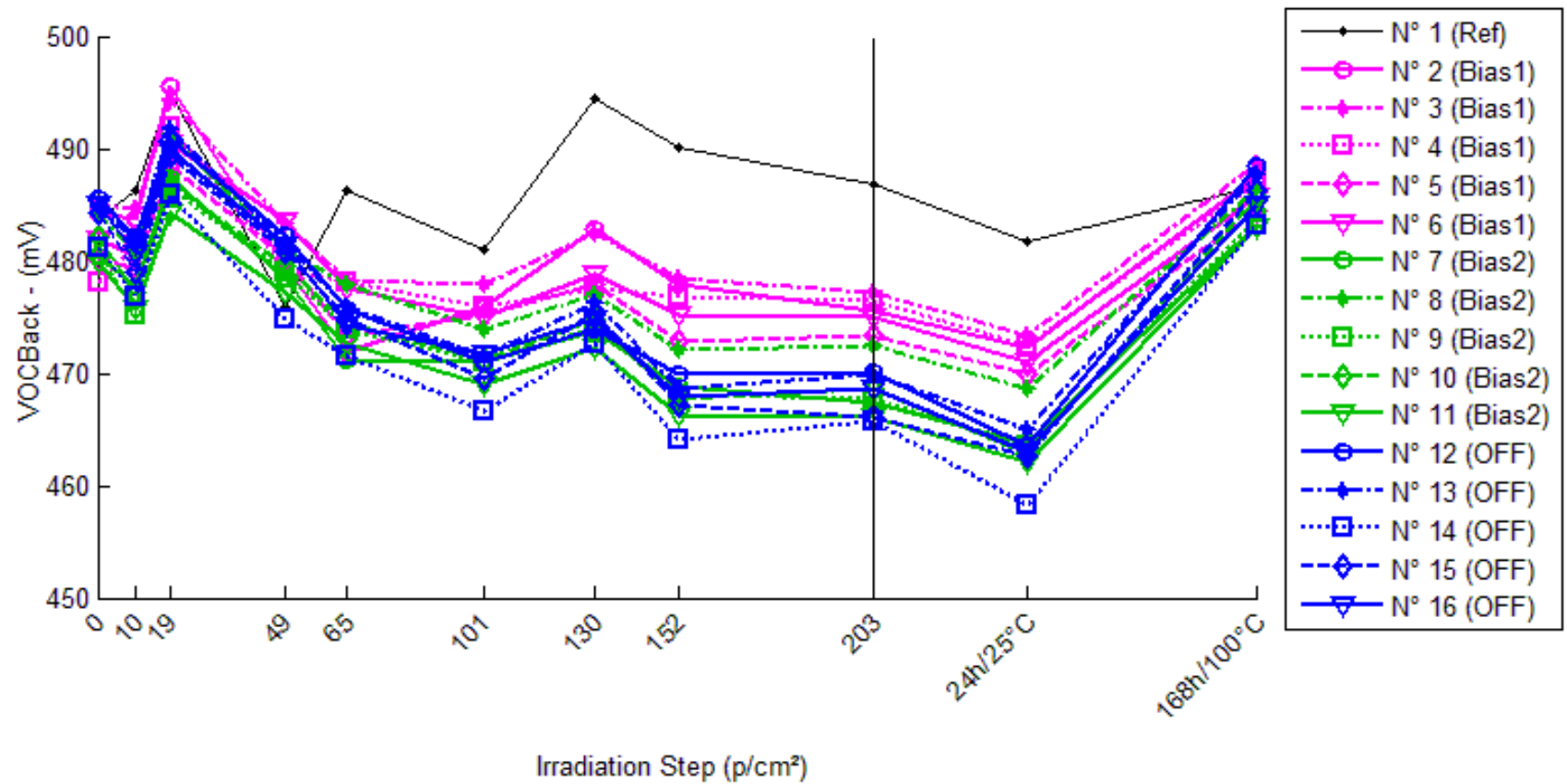

VOCBack . (mV)

	0krad(Si)	10krad(Si)	19krad(Si)	49krad(Si)	65krad(Si)	101krad(Si)	130krad(Si)	152krad(Si)	203krad(Si)	24h/25°C	168h/100°C
N° 1 (Ref)	483.690	486.337	495.048	475.834	486.192	480.997	494.402	490.039	486.817	481.807	486.615
N° 2 (Bias1)	484.356	483.693	495.482	479.528	471.856	475.956	482.796	477.879	475.563	472.352	487.614
N° 3 (Bias1)	484.942	484.614	494.253	483.373	478.312	477.880	482.430	478.422	477.151	473.393	488.578
N° 4 (Bias1)	478.143	481.437	491.997	479.330	478.118	475.998	477.507	476.808	476.410	472.529	487.082
N° 5 (Bias1)	480.178	479.395	488.382	480.344	473.303	475.217	477.918	472.902	473.277	469.879	484.415
N° 6 (Bias1)	481.840	480.463	490.481	483.536	477.605	475.016	478.791	475.193	475.008	470.981	485.650
N° 7 (Bias2)	480.392	477.670	487.289	478.487	471.178	471.086	473.802	468.845	467.427	463.723	483.197
N° 8 (Bias2)	484.032	480.845	491.243	481.002	477.924	473.821	476.995	472.177	472.384	468.714	486.461
N° 9 (Bias2)	480.964	475.162	486.378	478.982	473.897	470.944	474.064	468.176	467.653	463.577	483.743
N° 10 (Bias2)	482.003	477.224	486.847	479.519	474.534	471.229	474.762	467.741	468.646	462.728	485.801
N° 11 (Bias2)	479.917	475.790	484.229	477.222	472.563	468.938	472.352	466.212	466.136	462.111	482.954
N° 12 (OFF)	485.506	482.070	490.760	482.217	475.678	470.992	473.884	469.850	470.091	463.533	488.386
N° 13 (OFF)	484.841	481.858	491.803	481.517	475.923	471.609	476.260	468.662	469.985	464.919	487.650
N° 14 (OFF)	481.168	476.750	485.991	474.794	471.538	466.668	472.654	464.175	465.640	458.217	483.132
N° 15 (OFF)	484.343	478.979	489.404	480.810	474.775	469.615	475.390	467.113	466.021	462.698	486.208
N° 16 (OFF)	484.961	480.612	489.993	481.358	474.267	471.718	474.759	467.980	468.622	462.943	485.088

Delta [VOCBack]

	0krad(Si)	10krad(Si)	19krad(Si)	49krad(Si)	65krad(Si)	101krad(Si)	130krad(Si)	152krad(Si)	203krad(Si)	24h/25°C	168h/100°C
N° 1 (Ref)	---	2.647E+0	1.136E+1	-7.857E+0	2.502E+0	-2.694E+0	1.071E+1	6.348E+0	3.127E+0	-1.883E+0	2.925E+0
N° 2 (Bias1)	---	-6.635E-1	1.113E+1	-4.828E+0	-1.250E+1	-8.400E+0	-1.561E+0	-6.478E+0	-8.793E+0	-1.200E+1	3.258E+0
N° 3 (Bias1)	---	-3.284E-1	9.311E+0	-1.569E+0	-6.630E+0	-7.062E+0	-2.512E+0	-6.520E+0	-7.791E+0	-1.155E+1	3.636E+0
N° 4 (Bias1)	---	3.294E+0	1.385E+1	1.187E+0	-2.510E-2	-2.145E+0	-6.356E-1	-1.335E+0	-1.733E+0	-5.614E+0	8.940E+0
N° 5 (Bias1)	---	-7.838E-1	8.204E+0	1.652E-1	-6.875E+0	-4.962E+0	-2.261E+0	-7.277E+0	-6.901E+0	-1.030E+1	4.237E+0
N° 6 (Bias1)	---	-1.377E+0	8.642E+0	1.696E+0	-4.235E+0	-6.823E+0	-3.049E+0	-6.646E+0	-6.832E+0	-1.086E+1	3.810E+0
N° 7 (Bias2)	---	-2.722E+0	6.897E+0	-1.905E+0	-9.214E+0	-9.307E+0	-6.590E+0	-1.155E+1	-1.296E+1	-1.667E+1	2.804E+0
N° 8 (Bias2)	---	-3.187E+0	7.210E+0	-3.030E+0	-6.108E+0	-1.021E+1	-7.037E+0	-1.186E+1	-1.165E+1	-1.532E+1	2.428E+0
N° 9 (Bias2)	---	-5.802E+0	5.414E+0	-1.982E+0	-7.067E+0	-1.002E+1	-6.900E+0	-1.279E+1	-1.331E+1	-1.739E+1	2.779E+0
N° 10 (Bias2)	---	-4.779E+0	4.844E+0	-2.484E+0	-7.469E+0	-1.077E+1	-7.242E+0	-1.426E+1	-1.336E+1	-1.927E+1	3.798E+0
N° 11 (Bias2)	---	-4.126E+0	4.312E+0	-2.695E+0	-7.353E+0	-1.098E+1	-7.565E+0	-1.370E+1	-1.378E+1	-1.781E+1	3.037E+0
N° 12 (OFF)	---	-3.436E+0	5.254E+0	-3.289E+0	-9.828E+0	-1.451E+1	-1.162E+1	-1.566E+1	-1.541E+1	-2.197E+1	2.880E+0
N° 13 (OFF)	---	-2.983E+0	6.962E+0	-3.324E+0	-8.918E+0	-1.323E+1	-8.580E+0	-1.618E+1	-1.486E+1	-1.992E+1	2.809E+0
N° 14 (OFF)	---	-4.418E+0	4.822E+0	-6.374E+0	-9.630E+0	-1.450E+1	-8.514E+0	-1.699E+1	-1.553E+1	-2.295E+1	1.963E+0
N° 15 (OFF)	---	-5.364E+0	5.061E+0	-3.534E+0	-9.568E+0	-1.473E+1	-8.954E+0	-1.723E+1	-1.832E+1	-2.165E+1	1.865E+0
N° 16 (OFF)	---	-4.349E+0	5.032E+0	-3.602E+0	-1.069E+1	-1.324E+1	-1.020E+1	-1.698E+1	-1.634E+1	-2.202E+1	1.274E-1
Average (Bias1)	---	2.836E-2	1.023E+1	-6.699E-1	-6.053E+0	-5.879E+0	-2.004E+0	-5.651E+0	-6.410E+0	-1.007E+1	4.776E+0
σ (Bias1)	---	1.865E+0	2.313E+0	2.638E+0	4.534E+0	2.420E+0	9.333E-1	2.434E+0	2.733E+0	2.572E+0	2.354E+0
Average+3σ (Bias1)	---	5.622E+0	1.717E+1	7.245E+0	7.548E+0	1.382E+0	7.963E-1	1.652E+0	1.790E+0	-2.350E+0	1.184E+1
Average-3σ (Bias1)	---	-5.566E+0	3.287E+0	-8.585E+0	-1.965E+1	-1.314E+1	-4.803E+0	-1.295E+1	-1.461E+1	-1.778E+1	-2.286E+0
Average (Bias2)	---	-4.124E+0	5.735E+0	-2.419E+0	-7.442E+0	-1.026E+1	-7.067E+0	-1.283E+1	-1.301E+1	-1.729E+1	2.969E+0
σ (Bias2)	---	1.234E+0	1.270E+0	4.766E-1	1.126E+0	6.615E-1	3.654E-1	1.163E+0	8.157E-1	1.457E+0	5.117E-1
Average+3σ (Bias2)	---	-4.225E-1	9.544E+0	-9.894E-1	-4.066E+0	-8.274E+0	-5.971E+0	-9.342E+0	-1.057E+1	-1.292E+1	4.505E+0
Average-3σ (Bias2)	---	-7.825E+0	1.926E+0	-3.849E+0	-1.082E+1	-1.224E+1	-8.163E+0	-1.632E+1	-1.546E+1	-2.166E+1	1.434E+0
Average (OFF)	---	-4.110E+0	5.426E+0	-4.025E+0	-9.728E+0	-1.404E+1	-9.574E+0	-1.661E+1	-1.609E+1	-2.170E+1	1.929E+0
σ (OFF)	---	9.286E-1	8.722E-1	1.320E+0	6.392E-1	7.416E-1	1.331E+0	6.645E-1	1.355E+0	1.108E+0	1.110E+0
Average+3σ (OFF)	---	-1.324E+0	8.043E+0	-6.360E-2	-7.810E+0	-1.182E+1	-5.582E+0	-1.461E+1	-1.203E+1	-1.838E+1	5.260E+0
Average-3σ (OFF)	---	-6.896E+0	2.810E+0	-7.986E+0	-1.165E+1	-1.627E+1	-1.357E+1	-1.860E+1	-2.016E+1	-2.502E+1	-1.402E+0

7. Ip1

Ta = 25°C; IF = 10 mA ; Vdet = -15 V

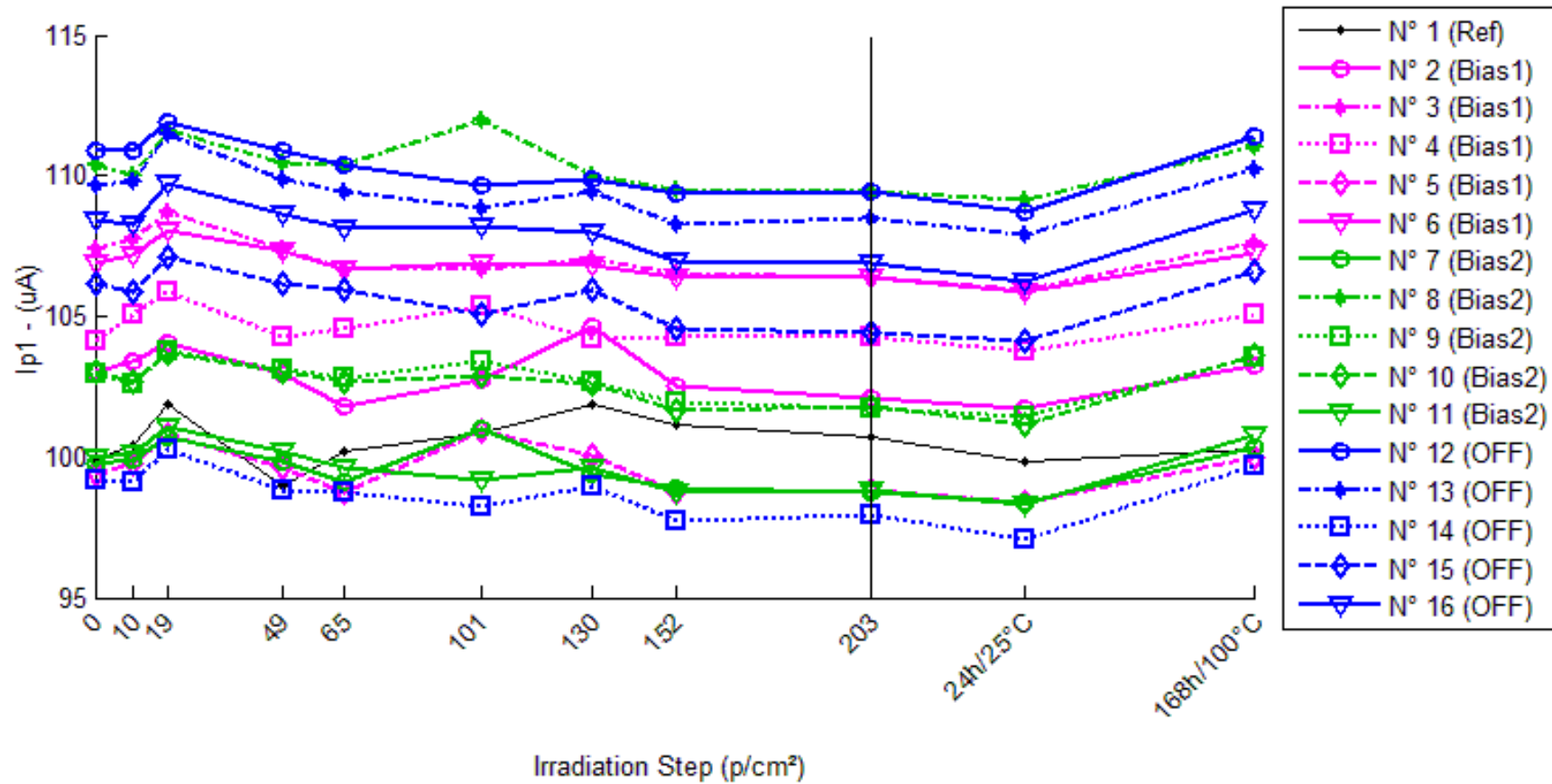

Ip1 . (uA)

	0krad(Si)	10krad(Si)	19krad(Si)	49krad(Si)	65krad(Si)	101krad(Si)	130krad(Si)	152krad(Si)	203krad(Si)	24h/25°C	168h/100°C
N° 1 (Ref)	99.889	100.430	101.867	98.948	100.203	100.849	101.886	101.181	100.705	99.870	100.276
N° 2 (Bias1)	103.003	103.368	104.039	102.947	101.800	102.757	104.667	102.505	102.106	101.712	103.233
N° 3 (Bias1)	107.405	107.730	108.732	107.386	106.656	106.674	107.013	106.511	106.407	105.963	107.594
N° 4 (Bias1)	104.159	105.040	105.842	104.297	104.561	105.356	104.195	104.266	104.268	103.729	105.087
N° 5 (Bias1)	99.418	99.784	100.748	99.643	98.761	100.962	100.074	98.717	98.853	98.348	100.016
N° 6 (Bias1)	106.923	107.168	108.027	107.313	106.691	106.881	106.806	106.358	106.357	105.899	107.254
N° 7 (Bias2)	99.750	99.912	100.711	99.860	99.088	100.975	99.393	98.910	98.718	98.403	100.341
N° 8 (Bias2)	110.398	110.001	111.633	110.421	110.373	111.963	109.982	109.539	109.467	109.174	111.020
N° 9 (Bias2)	102.979	102.576	103.797	103.107	102.798	103.432	102.647	101.944	101.749	101.422	103.529
N° 10 (Bias2)	103.030	102.703	103.683	103.007	102.674	102.906	102.617	101.645	101.776	101.152	103.641
N° 11 (Bias2)	99.986	100.108	101.076	100.192	99.608	99.148	99.616	98.718	98.802	98.306	100.804
N° 12 (OFF)	110.856	110.863	111.892	110.912	110.397	109.669	109.882	109.361	109.439	108.686	111.411
N° 13 (OFF)	109.666	109.810	111.466	109.847	109.441	108.834	109.413	108.279	108.458	107.926	110.241
N° 14 (OFF)	99.205	99.136	100.239	98.838	98.761	98.219	98.941	97.696	97.962	97.108	99.694
N° 15 (OFF)	106.196	105.895	107.127	106.171	105.924	105.078	105.958	104.537	104.420	104.115	106.635
N° 16 (OFF)	108.452	108.275	109.691	108.633	108.157	108.203	108.018	106.949	106.908	106.267	108.769

Delta [Ip1]

	0krad(Si)	10krad(Si)	19krad(Si)	49krad(Si)	65krad(Si)	101krad(Si)	130krad(Si)	152krad(Si)	203krad(Si)	24h/25°C	168h/100°C
N° 1 (Ref)	---	5.415E-1	1.979E+0	-9.402E-1	3.146E-1	9.602E-1	1.997E+0	1.293E+0	8.167E-1	-1.835E-2	3.877E-1
N° 2 (Bias1)	---	3.647E-1	1.036E+0	-5.600E-2	-1.203E+0	-2.463E-1	1.664E+0	-4.985E-1	-8.971E-1	-1.291E+0	2.293E-1
N° 3 (Bias1)	---	3.258E-1	1.328E+0	-1.860E-2	-7.489E-1	-7.303E-1	-3.918E-1	-8.931E-1	-9.980E-1	-1.442E+0	1.890E-1
N° 4 (Bias1)	---	8.813E-1	1.683E+0	1.375E-1	4.017E-1	1.197E+0	3.610E-2	1.064E-1	1.086E-1	-4.301E-1	9.279E-1
N° 5 (Bias1)	---	3.658E-1	1.330E+0	2.246E-1	-6.578E-1	1.543E+0	6.552E-1	-7.014E-1	-5.657E-1	-1.070E+0	5.977E-1
N° 6 (Bias1)	---	2.445E-1	1.103E+0	3.896E-1	-2.326E-1	-4.200E-2	-1.170E-1	-5.651E-1	-5.664E-1	-1.024E+0	3.308E-1
N° 7 (Bias2)	---	1.615E-1	9.611E-1	1.101E-1	-6.620E-1	1.225E+0	-3.574E-1	-8.402E-1	-1.033E+0	-1.347E+0	5.906E-1
N° 8 (Bias2)	---	-3.973E-1	1.235E+0	2.300E-2	-2.500E-2	1.565E+0	-4.159E-1	-8.590E-1	-9.315E-1	-1.224E+0	6.221E-1
N° 9 (Bias2)	---	-4.036E-1	8.175E-1	1.279E-1	-1.817E-1	4.531E-1	-3.321E-1	-1.035E+0	-1.230E+0	-1.557E+0	5.501E-1
N° 10 (Bias2)	---	-3.273E-1	6.528E-1	-2.350E-2	-3.568E-1	-1.240E-1	-4.138E-1	-1.385E+0	-1.254E+0	-1.878E+0	6.109E-1
N° 11 (Bias2)	---	1.218E-1	1.090E+0	2.058E-1	-3.785E-1	-8.384E-1	-3.701E-1	-1.268E+0	-1.184E+0	-1.680E+0	8.175E-1
N° 12 (OFF)	---	6.700E-3	1.036E+0	5.590E-2	-4.589E-1	-1.188E+0	-9.748E-1	-1.496E+0	-1.417E+0	-2.171E+0	5.547E-1
N° 13 (OFF)	---	1.441E-1	1.800E+0	1.814E-1	-2.254E-1	-8.324E-1	-2.527E-1	-1.387E+0	-1.208E+0	-1.740E+0	5.752E-1
N° 14 (OFF)	---	-6.883E-2	1.034E+0	-3.673E-1	-4.440E-1	-9.865E-1	-2.643E-1	-1.510E+0	-1.243E+0	-2.097E+0	4.889E-1
N° 15 (OFF)	---	-3.015E-1	9.313E-1	-2.530E-2	-2.723E-1	-1.118E+0	-2.383E-1	-1.659E+0	-1.776E+0	-2.081E+0	4.393E-1
N° 16 (OFF)	---	-1.773E-1	1.239E+0	1.811E-1	-2.956E-1	-2.495E-1	-4.346E-1	-1.503E+0	-1.545E+0	-2.185E+0	3.170E-1
Average (Bias1)	---	4.364E-1	1.296E+0	1.354E-1	-4.882E-1	3.442E-1	3.693E-1	-5.103E-1	-5.837E-1	-1.051E+0	4.549E-1
σ (Bias1)	---	2.535E-1	2.534E-1	1.823E-1	6.052E-1	9.768E-1	8.192E-1	3.763E-1	4.329E-1	3.862E-1	3.087E-1
Average+3σ (Bias1)	---	1.197E+0	2.056E+0	6.823E-1	1.328E+0	3.275E+0	2.827E+0	6.187E-1	7.151E-1	1.073E-1	1.381E+0
Average-3σ (Bias1)	---	-3.242E-1	5.358E-1	-4.115E-1	-2.304E+0	-2.586E+0	-2.088E+0	-1.639E+0	-1.883E+0	-2.210E+0	-4.711E-1
Average (Bias2)	---	-1.690E-1	9.513E-1	8.865E-2	-3.208E-1	4.561E-1	-3.779E-1	-1.078E+0	-1.127E+0	-1.538E+0	6.382E-1
σ (Bias2)	---	2.855E-1	2.274E-1	9.029E-2	2.387E-1	9.788E-1	3.644E-2	2.433E-1	1.389E-1	2.604E-1	1.039E-1
Average+3σ (Bias2)	---	6.875E-1	1.634E+0	3.595E-1	3.952E-1	3.393E+0	-2.685E-1	-3.477E-1	-7.097E-1	-7.564E-1	9.500E-1
Average-3σ (Bias2)	---	-1.025E+0	2.690E-1	-1.822E-1	-1.037E+0	-2.480E+0	-4.872E-1	-1.807E+0	-1.543E+0	-2.319E+0	3.265E-1
Average (OFF)	---	-7.937E-2	1.208E+0	5.166E-3	-3.392E-1	-8.748E-1	-4.329E-1	-1.511E+0	-1.438E+0	-2.055E+0	4.750E-1
σ (OFF)	---	1.706E-1	3.494E-1	2.260E-1	1.056E-1	3.749E-1	3.132E-1	9.682E-2	2.331E-1	1.816E-1	1.035E-1
Average+3σ (OFF)	---	4.324E-1	2.256E+0	6.830E-1	-2.231E-2	2.500E-1	5.067E-1	-1.220E+0	-7.384E-1	-1.510E+0	7.854E-1
Average-3σ (OFF)	---	-5.911E-1	1.598E-1	-6.727E-1	-6.562E-1	-2.000E+0	-1.373E+0	-1.801E+0	-2.137E+0	-2.600E+0	1.646E-1

8. K1

Ta = 25°C; IF = 10 mA ; Vdet = -15 V

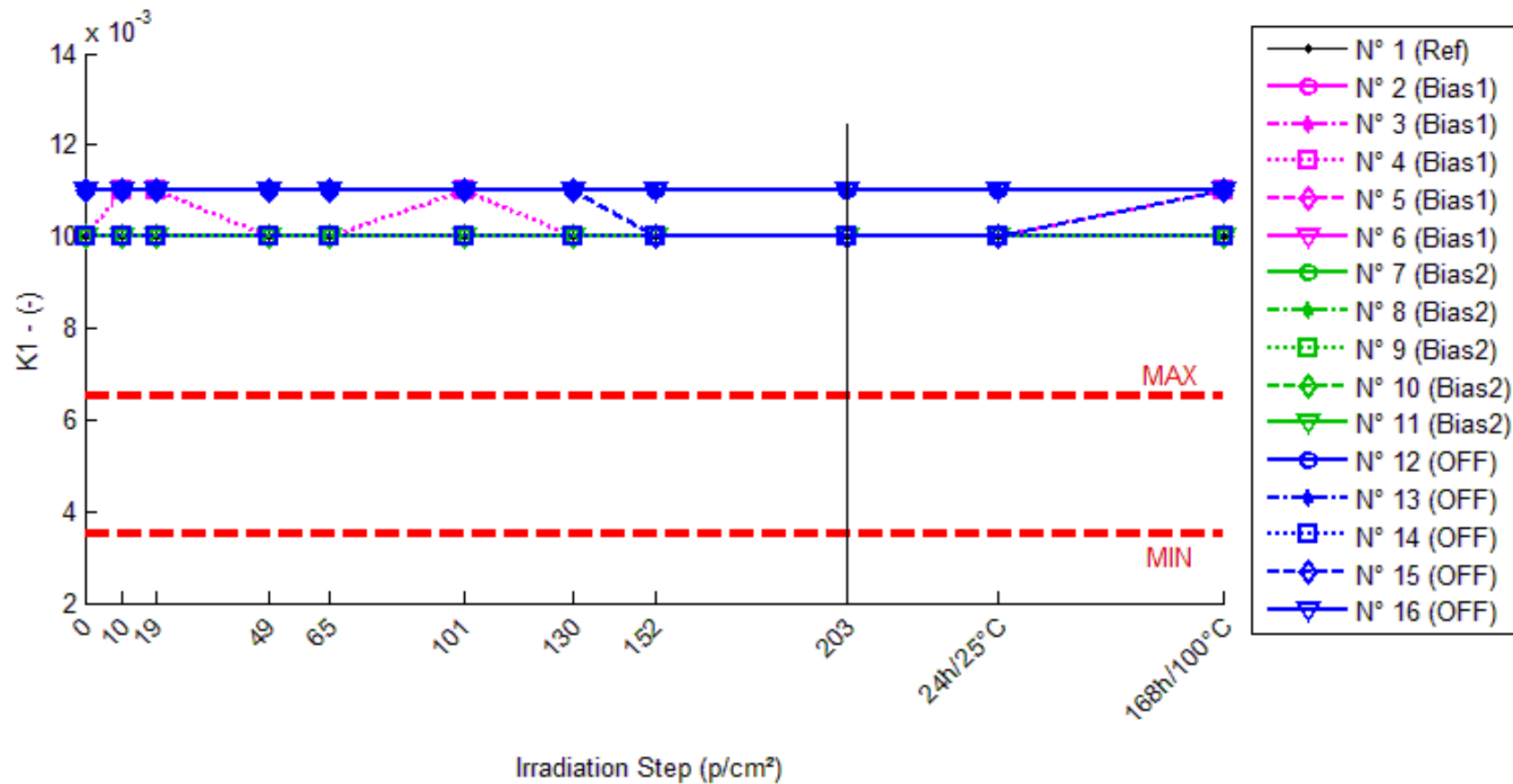

K1. (-)

Min = 0.0035 Max = 0.0065

	0krad(Si)	10krad(Si)	19krad(Si)	49krad(Si)	65krad(Si)	101krad(Si)	130krad(Si)	152krad(Si)	203krad(Si)	24h/25°C	168h/100°C
N° 1 (Ref)	9.989E-3	1.004E-2	1.019E-2	9.895E-3	1.002E-2	1.008E-2	1.019E-2	1.012E-2	1.007E-2	9.987E-3	1.003E-2
N° 2 (Bias1)	1.030E-2	1.034E-2	1.040E-2	1.029E-2	1.018E-2	1.028E-2	1.047E-2	1.025E-2	1.021E-2	1.017E-2	1.032E-2
N° 3 (Bias1)	1.074E-2	1.077E-2	1.087E-2	1.074E-2	1.067E-2	1.067E-2	1.070E-2	1.065E-2	1.064E-2	1.060E-2	1.076E-2
N° 4 (Bias1)	1.042E-2	1.050E-2	1.058E-2	1.043E-2	1.046E-2	1.054E-2	1.042E-2	1.043E-2	1.043E-2	1.037E-2	1.051E-2
N° 5 (Bias1)	9.942E-3	9.978E-3	1.007E-2	9.964E-3	9.876E-3	1.010E-2	1.001E-2	9.872E-3	9.885E-3	9.835E-3	1.000E-2
N° 6 (Bias1)	1.069E-2	1.072E-2	1.080E-2	1.073E-2	1.067E-2	1.069E-2	1.068E-2	1.064E-2	1.064E-2	1.059E-2	1.073E-2
N° 7 (Bias2)	9.975E-3	9.991E-3	1.007E-2	9.986E-3	9.909E-3	1.010E-2	9.939E-3	9.891E-3	9.872E-3	9.840E-3	1.003E-2
N° 8 (Bias2)	1.104E-2	1.100E-2	1.116E-2	1.104E-2	1.104E-2	1.120E-2	1.100E-2	1.095E-2	1.095E-2	1.092E-2	1.110E-2
N° 9 (Bias2)	1.030E-2	1.026E-2	1.038E-2	1.031E-2	1.028E-2	1.034E-2	1.026E-2	1.019E-2	1.017E-2	1.014E-2	1.035E-2
N° 10 (Bias2)	1.030E-2	1.027E-2	1.037E-2	1.030E-2	1.027E-2	1.029E-2	1.026E-2	1.016E-2	1.018E-2	1.012E-2	1.036E-2
N° 11 (Bias2)	9.999E-3	1.001E-2	1.011E-2	1.002E-2	9.961E-3	9.915E-3	9.962E-3	9.872E-3	9.880E-3	9.831E-3	1.008E-2
N° 12 (OFF)	1.109E-2	1.109E-2	1.119E-2	1.109E-2	1.104E-2	1.097E-2	1.099E-2	1.094E-2	1.094E-2	1.087E-2	1.114E-2
N° 13 (OFF)	1.097E-2	1.098E-2	1.115E-2	1.098E-2	1.094E-2	1.088E-2	1.094E-2	1.083E-2	1.085E-2	1.079E-2	1.102E-2
N° 14 (OFF)	9.921E-3	9.914E-3	1.002E-2	9.884E-3	9.876E-3	9.822E-3	9.894E-3	9.770E-3	9.796E-3	9.711E-3	9.969E-3
N° 15 (OFF)	1.062E-2	1.059E-2	1.071E-2	1.062E-2	1.059E-2	1.051E-2	1.060E-2	1.045E-2	1.044E-2	1.041E-2	1.066E-2
N° 16 (OFF)	1.085E-2	1.083E-2	1.097E-2	1.086E-2	1.082E-2	1.082E-2	1.080E-2	1.069E-2	1.069E-2	1.063E-2	1.088E-2

Delta [K1]

	0krad(Si)	10krad(Si)	19krad(Si)	49krad(Si)	65krad(Si)	101krad(Si)	130krad(Si)	152krad(Si)	203krad(Si)	24h/25°C	168h/100°C
N° 1 (Ref)	---	5.415E-5	1.979E-4	-9.402E-5	3.146E-5	9.602E-5	1.997E-4	1.293E-4	8.167E-5	-1.835E-6	3.877E-5
N° 2 (Bias1)	---	3.647E-5	1.036E-4	-5.600E-6	-1.203E-4	-2.463E-5	1.664E-4	-4.985E-5	-8.971E-5	-1.291E-4	2.293E-5
N° 3 (Bias1)	---	3.258E-5	1.328E-4	-1.860E-6	-7.489E-5	-7.303E-5	-3.918E-5	-8.931E-5	-9.980E-5	-1.442E-4	1.890E-5
N° 4 (Bias1)	---	8.813E-5	1.683E-4	1.375E-5	4.017E-5	1.197E-4	3.610E-6	1.064E-5	1.086E-5	-4.301E-5	9.279E-5
N° 5 (Bias1)	---	3.658E-5	1.330E-4	2.245E-5	-6.578E-5	1.543E-4	6.552E-5	-7.014E-5	-5.657E-5	-1.070E-4	5.977E-5
N° 6 (Bias1)	---	2.445E-5	1.104E-4	3.896E-5	-2.326E-5	-4.200E-6	-1.170E-5	-5.651E-5	-5.664E-5	-1.024E-4	3.308E-5
N° 7 (Bias2)	---	1.615E-5	9.611E-5	1.100E-5	-6.620E-5	1.225E-4	-3.574E-5	-8.402E-5	-1.033E-4	-1.347E-4	5.906E-5
N° 8 (Bias2)	---	-3.973E-5	1.235E-4	2.300E-6	-2.500E-6	1.565E-4	-4.159E-5	-8.590E-5	-9.315E-5	-1.224E-4	6.221E-5
N° 9 (Bias2)	---	-4.036E-5	8.175E-5	1.279E-5	-1.817E-5	4.531E-5	-3.321E-5	-1.035E-4	-1.230E-4	-1.557E-4	5.501E-5
N° 10 (Bias2)	---	-3.273E-5	6.528E-5	-2.350E-6	-3.568E-5	-1.240E-5	-4.138E-5	-1.385E-4	-1.254E-4	-1.878E-4	6.109E-5
N° 11 (Bias2)	---	1.218E-5	1.090E-4	2.058E-5	-3.785E-5	-8.384E-5	-3.701E-5	-1.268E-4	-1.184E-4	-1.680E-4	8.175E-5
N° 12 (OFF)	---	6.700E-7	1.036E-4	5.590E-6	-4.589E-5	-1.188E-4	-9.748E-5	-1.496E-4	-1.417E-4	-2.171E-4	5.547E-5
N° 13 (OFF)	---	1.441E-5	1.800E-4	1.814E-5	-2.254E-5	-8.324E-5	-2.527E-5	-1.387E-4	-1.208E-4	-1.740E-4	5.752E-5
N° 14 (OFF)	---	-6.883E-6	1.034E-4	-3.673E-5	-4.440E-5	-9.865E-5	-2.643E-5	-1.510E-4	-1.243E-4	-2.097E-4	4.889E-5
N° 15 (OFF)	---	-3.015E-5	9.313E-5	-2.530E-6	-2.723E-5	-1.118E-4	-2.383E-5	-1.659E-4	-1.776E-4	-2.081E-4	4.393E-5
N° 16 (OFF)	---	-1.773E-5	1.239E-4	1.811E-5	-2.956E-5	-2.495E-5	-4.346E-5	-1.503E-4	-1.545E-4	-2.185E-4	3.170E-5
Average (Bias1)	---	4.364E-5	1.296E-4	1.354E-5	-4.882E-5	3.442E-5	3.693E-5	-5.103E-5	-5.837E-5	-1.051E-4	4.549E-5
σ (Bias1)	---	2.535E-5	2.534E-5	1.823E-5	6.052E-5	9.768E-5	8.192E-5	3.763E-5	4.329E-5	3.862E-5	3.087E-5
Average+3σ (Bias1)	---	1.197E-4	2.056E-4	6.823E-5	1.328E-4	3.275E-4	2.827E-4	6.187E-5	7.151E-5	1.073E-5	1.381E-4
Average-3σ (Bias1)	---	-3.242E-5	5.358E-5	-4.115E-5	-2.304E-4	-2.586E-4	-2.088E-4	-1.639E-4	-1.883E-4	-2.210E-4	-4.711E-5
Average (Bias2)	---	-1.690E-5	9.513E-5	8.865E-6	-3.208E-5	4.561E-5	-3.779E-5	-1.078E-4	-1.127E-4	-1.538E-4	6.382E-5
σ (Bias2)	---	2.855E-5	2.274E-5	9.029E-6	2.387E-5	9.788E-5	3.644E-6	2.433E-5	1.389E-5	2.604E-5	1.039E-5
Average+3σ (Bias2)	---	6.875E-5	1.634E-4	3.595E-5	3.952E-5	3.393E-4	-2.685E-5	-3.477E-5	-7.097E-5	-7.564E-5	9.500E-5
Average-3σ (Bias2)	---	-1.025E-4	2.690E-5	-1.822E-5	-1.037E-4	-2.480E-4	-4.872E-5	-1.807E-4	-1.543E-4	-2.319E-4	3.265E-5
Average (OFF)	---	-7.937E-6	1.208E-4	5.166E-7	-3.392E-5	-8.748E-5	-4.329E-5	-1.511E-4	-1.438E-4	-2.055E-4	4.750E-5
σ (OFF)	---	1.706E-5	3.494E-5	2.260E-5	1.056E-5	3.749E-5	3.132E-5	9.682E-6	2.331E-5	1.816E-5	1.035E-5
Average+3σ (OFF)	---	4.324E-5	2.256E-4	6.830E-5	-2.231E-6	2.500E-5	5.067E-5	-1.220E-4	-7.384E-5	-1.510E-4	7.854E-5
Average-3σ (OFF)	---	-5.911E-5	1.598E-5	-6.727E-5	-6.562E-5	-2.000E-4	-1.373E-4	-1.801E-4	-2.137E-4	-2.600E-4	1.646E-5

9. K2-1

Ta = 25°C; IF = 10 mA ; Vdet = -15 V

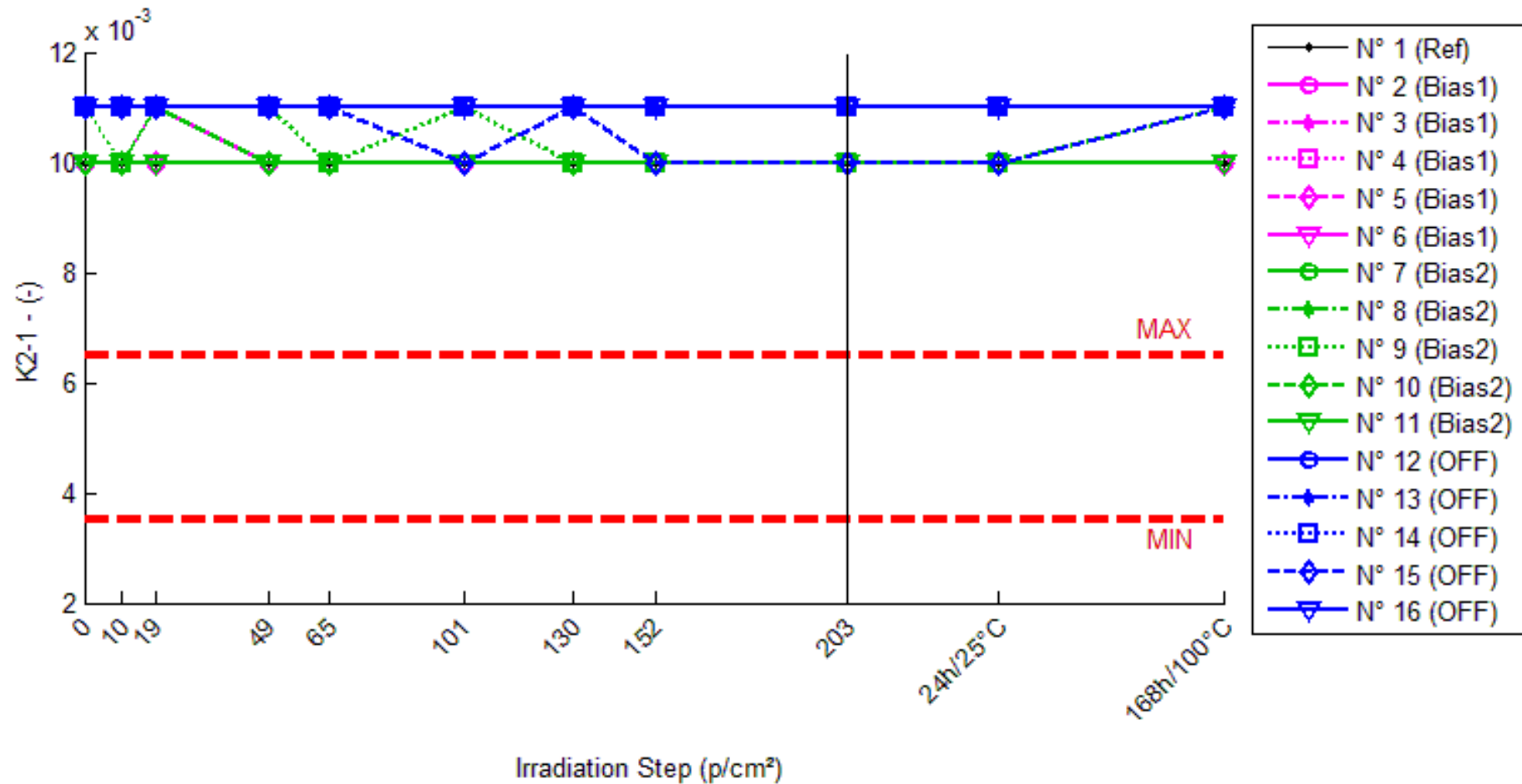

K2-1 . (-)

Min = 0.0035 Max = 0.0065

	0krad(Si)	10krad(Si)	19krad(Si)	49krad(Si)	65krad(Si)	101krad(Si)	130krad(Si)	152krad(Si)	203krad(Si)	24h/25°C	168h/100°C
N° 1 (Ref)	1.009E-2	1.015E-2	1.029E-2	1.000E-2	1.013E-2	1.019E-2	1.029E-2	1.023E-2	1.018E-2	1.009E-2	1.013E-2
N° 2 (Bias1)	1.004E-2	1.008E-2	1.013E-2	1.001E-2	9.892E-3	9.986E-3	1.017E-2	9.956E-3	9.917E-3	9.881E-3	1.006E-2
N° 3 (Bias1)	1.075E-2	1.077E-2	1.087E-2	1.073E-2	1.065E-2	1.066E-2	1.069E-2	1.064E-2	1.063E-2	1.059E-2	1.076E-2
N° 4 (Bias1)	1.073E-2	1.081E-2	1.090E-2	1.073E-2	1.076E-2	1.083E-2	1.071E-2	1.073E-2	1.073E-2	1.067E-2	1.082E-2
N° 5 (Bias1)	9.975E-3	1.000E-2	1.010E-2	9.982E-3	9.892E-3	1.011E-2	1.002E-2	9.885E-3	9.896E-3	9.847E-3	1.003E-2
N° 6 (Bias1)	1.042E-2	1.043E-2	1.052E-2	1.044E-2	1.038E-2	1.039E-2	1.038E-2	1.034E-2	1.034E-2	1.030E-2	1.044E-2
N° 7 (Bias2)	1.070E-2	1.071E-2	1.080E-2	1.070E-2	1.062E-2	1.081E-2	1.064E-2	1.059E-2	1.057E-2	1.053E-2	1.076E-2
N° 8 (Bias2)	1.094E-2	1.095E-2	1.105E-2	1.093E-2	1.093E-2	1.107E-2	1.088E-2	1.083E-2	1.083E-2	1.080E-2	1.099E-2
N° 9 (Bias2)	1.051E-2	1.046E-2	1.059E-2	1.052E-2	1.048E-2	1.055E-2	1.047E-2	1.039E-2	1.037E-2	1.034E-2	1.056E-2
N° 10 (Bias2)	1.047E-2	1.043E-2	1.054E-2	1.046E-2	1.042E-2	1.044E-2	1.041E-2	1.031E-2	1.032E-2	1.025E-2	1.054E-2
N° 11 (Bias2)	1.011E-2	1.012E-2	1.022E-2	1.012E-2	1.007E-2	1.001E-2	1.006E-2	9.971E-3	9.978E-3	9.929E-3	1.019E-2
N° 12 (OFF)	1.080E-2	1.080E-2	1.090E-2	1.080E-2	1.075E-2	1.067E-2	1.069E-2	1.064E-2	1.065E-2	1.058E-2	1.086E-2
N° 13 (OFF)	1.081E-2	1.082E-2	1.098E-2	1.082E-2	1.077E-2	1.070E-2	1.076E-2	1.064E-2	1.066E-2	1.060E-2	1.086E-2
N° 14 (OFF)	1.082E-2	1.050E-2	1.094E-2	1.078E-2	1.077E-2	1.071E-2	1.079E-2	1.065E-2	1.068E-2	1.058E-2	1.088E-2
N° 15 (OFF)	1.057E-2	1.054E-2	1.066E-2	1.056E-2	1.053E-2	1.044E-2	1.052E-2	1.038E-2	1.037E-2	1.034E-2	1.062E-2
N° 16 (OFF)	1.074E-2	1.072E-2	1.086E-2	1.075E-2	1.071E-2	1.070E-2	1.069E-2	1.058E-2	1.058E-2	1.051E-2	1.077E-2

Delta [K2-1]

	0krad(Si)	10krad(Si)	19krad(Si)	49krad(Si)	65krad(Si)	101krad(Si)	130krad(Si)	152krad(Si)	203krad(Si)	24h/25°C	168h/100°C
N° 1 (Ref)	---	5.544E-5	2.002E-4	-9.227E-5	3.685E-5	9.900E-5	2.005E-4	1.314E-4	8.276E-5	4.700E-7	4.074E-5
N° 2 (Bias1)	---	3.254E-5	8.956E-5	-3.526E-5	-1.504E-4	-5.694E-5	1.232E-4	-8.699E-5	-1.257E-4	-1.621E-4	2.007E-5
N° 3 (Bias1)	---	2.466E-5	1.200E-4	-1.698E-5	-9.244E-5	-9.073E-5	-5.972E-5	-1.079E-4	-1.187E-4	-1.610E-4	1.510E-5
N° 4 (Bias1)	---	8.617E-5	1.724E-4	3.790E-6	3.268E-5	1.045E-4	-1.296E-5	-1.980E-6	-1.760E-6	-5.989E-5	9.434E-5
N° 5 (Bias1)	---	2.776E-5	1.275E-4	6.205E-6	-8.362E-5	1.329E-4	4.445E-5	-9.025E-5	-7.955E-5	-1.285E-4	5.808E-5
N° 6 (Bias1)	---	1.716E-5	1.013E-4	2.141E-5	-3.923E-5	-2.269E-5	-3.499E-5	-7.565E-5	-7.491E-5	-1.176E-4	2.614E-5
N° 7 (Bias2)	---	8.990E-6	9.678E-5	-1.370E-6	-8.720E-5	1.087E-4	-6.370E-5	-1.148E-4	-1.346E-4	-1.683E-4	5.330E-5
N° 8 (Bias2)	---	1.700E-5	1.192E-4	-4.710E-6	-7.730E-6	1.394E-4	-5.572E-5	-1.008E-4	-1.080E-4	-1.352E-4	5.720E-5
N° 9 (Bias2)	---	-4.405E-5	8.588E-5	1.452E-5	-2.235E-5	4.352E-5	-3.944E-5	-1.114E-4	-1.318E-4	-1.655E-4	5.624E-5
N° 10 (Bias2)	---	-3.992E-5	6.830E-5	-6.990E-6	-4.982E-5	-3.311E-5	-6.171E-5	-1.631E-4	-1.492E-4	-2.176E-4	6.773E-5
N° 11 (Bias2)	---	7.500E-6	1.074E-4	1.303E-5	-4.442E-5	-9.759E-5	-4.950E-5	-1.411E-4	-1.336E-4	-1.827E-4	7.846E-5
N° 12 (OFF)	---	-1.840E-6	9.685E-5	-1.330E-6	-5.011E-5	-1.295E-4	-1.106E-4	-1.614E-4	-1.521E-4	-2.274E-4	5.262E-5
N° 13 (OFF)	---	1.025E-5	1.728E-4	8.050E-6	-3.676E-5	-1.043E-4	-5.082E-5	-1.663E-4	-1.500E-4	-2.030E-4	5.552E-5
N° 14 (OFF)	---	-3.191E-4	1.187E-4	-3.819E-5	-4.684E-5	-1.081E-4	-2.746E-5	-1.711E-4	-1.408E-4	-2.373E-4	5.788E-5
N° 15 (OFF)	---	-3.461E-5	8.732E-5	-1.109E-5	-3.745E-5	-1.299E-4	-4.639E-5	-1.881E-4	-1.997E-4	-2.304E-4	4.606E-5
N° 16 (OFF)	---	-1.708E-5	1.232E-4	1.413E-5	-3.268E-5	-3.308E-5	-5.288E-5	-1.593E-4	-1.619E-4	-2.260E-4	3.440E-5
Average (Bias1)	---	3.766E-5	1.222E-4	-4.167E-6	-6.660E-5	1.340E-5	1.199E-5	-7.255E-5	-8.011E-5	-1.258E-4	4.275E-5
σ (Bias1)	---	2.769E-5	3.183E-5	2.211E-5	6.817E-5	9.958E-5	7.313E-5	4.111E-5	4.931E-5	4.177E-5	3.336E-5
Average+3σ (Bias1)	---	1.207E-4	2.176E-4	6.217E-5	1.379E-4	3.121E-4	2.314E-4	5.077E-5	6.783E-5	-5.138E-7	1.428E-4
Average-3σ (Bias1)	---	-4.541E-5	2.668E-5	-7.051E-5	-2.711E-4	-2.853E-4	-2.074E-4	-1.959E-4	-2.280E-4	-2.511E-4	-5.733E-5
Average (Bias2)	---	-1.010E-5	9.552E-5	2.896E-6	-4.230E-5	3.217E-5	-5.401E-5	-1.263E-4	-1.315E-4	-1.738E-4	6.259E-5
σ (Bias2)	---	2.937E-5	1.961E-5	1.014E-5	3.029E-5	9.820E-5	9.858E-6	2.536E-5	1.483E-5	2.995E-5	1.042E-5
Average+3σ (Bias2)	---	7.801E-5	1.544E-4	3.333E-5	4.857E-5	3.268E-4	-2.444E-5	-5.017E-5	-8.697E-5	-8.400E-5	9.383E-5
Average-3σ (Bias2)	---	-9.821E-5	3.668E-5	-2.754E-5	-1.332E-4	-2.624E-4	-8.359E-5	-2.023E-4	-1.759E-4	-2.637E-4	3.134E-5
Average (OFF)	---	-7.248E-5	1.198E-4	-5.686E-6	-4.077E-5	-1.010E-4	-5.762E-5	-1.693E-4	-1.609E-4	-2.248E-4	4.930E-5
σ (OFF)	---	1.389E-4	3.316E-5	2.053E-5	7.359E-6	3.976E-5	3.125E-5	1.149E-5	2.295E-5	1.291E-5	9.432E-6
Average+3σ (OFF)	---	3.442E-4	2.193E-4	5.591E-5	-1.869E-5	1.829E-5	3.613E-5	-1.348E-4	-9.204E-5	-1.861E-4	7.759E-5
Average-3σ (OFF)	---	-4.892E-4	2.028E-5	-6.728E-5	-6.285E-5	-2.202E-4	-1.514E-4	-2.037E-4	-2.298E-4	-2.635E-4	2.100E-5

10.K2-2

Ta = 25°C; IF = 1 mA ; Vdet = -15 V

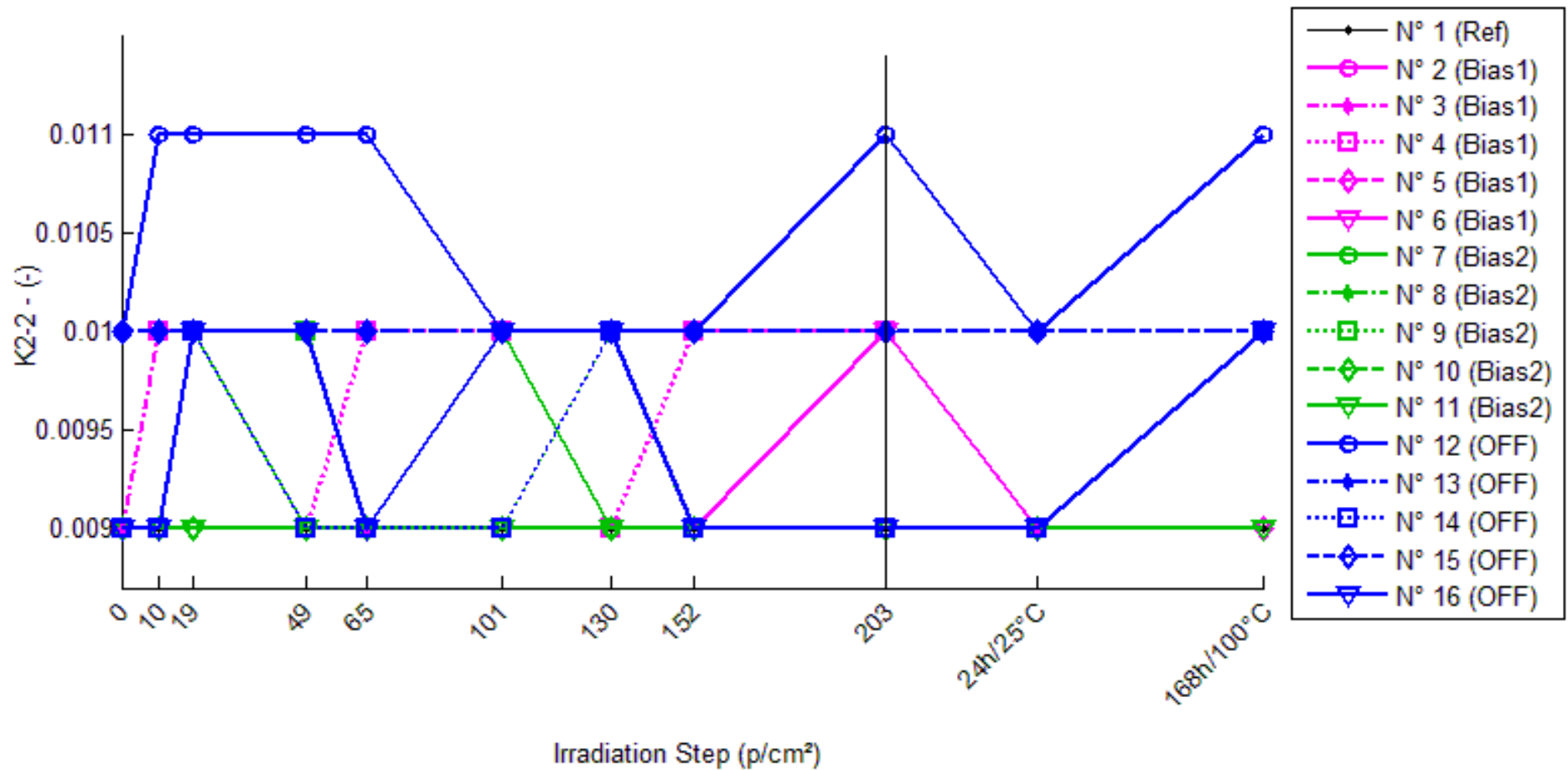

K2-2 . (-)

	0krad(Si)	10krad(Si)	19krad(Si)	49krad(Si)	65krad(Si)	101krad(Si)	130krad(Si)	152krad(Si)	203krad(Si)	24h/25°C	168h/100°C
N° 1 (Ref)	9.044E-3	9.087E-3	9.587E-3	8.958E-3	9.117E-3	9.180E-3	9.388E-3	9.317E-3	9.290E-3	9.127E-3	9.074E-3
N° 2 (Bias1)	9.424E-3	9.469E-3	9.562E-3	9.687E-3	9.311E-3	9.589E-3	9.629E-3	9.594E-3	9.582E-3	9.408E-3	9.565E-3
N° 3 (Bias1)	9.409E-3	9.527E-3	9.543E-3	9.696E-3	9.484E-3	9.554E-3	9.549E-3	9.506E-3	9.601E-3	9.399E-3	9.550E-3
N° 4 (Bias1)	9.197E-3	9.500E-3	9.628E-3	9.401E-3	9.567E-3	9.576E-3	9.415E-3	9.574E-3	9.651E-3	9.441E-3	9.579E-3
N° 5 (Bias1)	9.043E-3	9.142E-3	9.295E-3	9.167E-3	9.034E-3	9.310E-3	9.257E-3	9.128E-3	9.245E-3	9.114E-3	9.317E-3
N° 6 (Bias1)	9.285E-3	9.385E-3	9.520E-3	9.522E-3	9.424E-3	9.373E-3	9.414E-3	9.413E-3	9.510E-3	9.332E-3	9.504E-3
N° 7 (Bias2)	9.310E-3	9.378E-3	9.508E-3	9.490E-3	9.242E-3	9.501E-3	9.444E-3	9.333E-3	9.377E-3	9.301E-3	9.543E-3
N° 8 (Bias2)	9.571E-3	9.658E-3	9.853E-3	9.723E-3	9.772E-3	9.801E-3	9.739E-3	9.638E-3	9.766E-3	9.709E-3	9.843E-3
N° 9 (Bias2)	9.379E-3	9.232E-3	9.505E-3	9.551E-3	9.438E-3	9.469E-3	9.515E-3	9.372E-3	9.334E-3	9.291E-3	9.612E-3
N° 10 (Bias2)	9.218E-3	9.284E-3	9.466E-3	9.460E-3	9.382E-3	9.375E-3	9.410E-3	9.241E-3	9.323E-3	9.145E-3	9.611E-3
N° 11 (Bias2)	8.681E-3	8.804E-3	8.951E-3	8.913E-3	8.869E-3	8.760E-3	8.887E-3	8.710E-3	8.765E-3	8.709E-3	9.069E-3
N° 12 (OFF)	1.046E-2	1.054E-2	1.072E-2	1.060E-2	1.053E-2	1.038E-2	1.042E-2	1.037E-2	1.050E-2	1.028E-2	1.071E-2
N° 13 (OFF)	1.011E-2	1.016E-2	1.049E-2	1.027E-2	1.021E-2	1.015E-2	1.031E-2	1.002E-2	1.019E-2	1.007E-2	1.038E-2
N° 14 (OFF)	9.313E-3	9.365E-3	9.631E-3	9.290E-3	9.442E-3	9.342E-3	9.557E-3	9.211E-3	9.411E-3	9.143E-3	9.619E-3
N° 15 (OFF)	1.004E-2	9.968E-3	1.028E-2	1.012E-2	1.015E-2	1.001E-2	1.020E-2	9.923E-3	9.964E-3	9.931E-3	1.032E-2
N° 16 (OFF)	9.426E-3	9.422E-3	9.739E-3	9.580E-3	9.476E-3	9.513E-3	9.609E-3	9.382E-3	9.479E-3	9.303E-3	9.661E-3

Delta [K2-2]

	krad(Si)	0krad(Si)	9krad(Si)	9krad(Si)	5krad(Si)	01krad(Si)	30krad(Si)	52krad(Si)	03krad(Si)	4h/25°C	68h/100°C
° 1 (Ref)	--	249E-5	429E-4	8.685E-5	312E-5	352E-4	438E-4	730E-4	453E-4	300E-5	950E-5
° 2 (Bias1)	--	494E-5	380E-4	630E-4	1.133E-4	648E-4	045E-4	695E-4	581E-4	1.624E-5	413E-4
° 3 (Bias1)	--	174E-4	337E-4	864E-4	536E-5	449E-4	395E-4	727E-5	915E-4	8.850E-6	404E-4
° 4 (Bias1)	--	029E-4	310E-4	040E-4	698E-4	786E-4	176E-4	766E-4	542E-4	439E-4	817E-4
° 5 (Bias1)	--	910E-5	525E-4	237E-4	9.162E-6	669E-4	142E-4	553E-5	018E-4	160E-5	740E-4
° 6 (Bias1)	--	004E-4	354E-4	371E-4	397E-4	846E-5	295E-4	286E-4	256E-4	694E-5	188E-4
° 7 (Bias2)	--	795E-5	979E-4	793E-4	6.796E-5	909E-4	332E-4	253E-5	647E-5	9.211E-6	329E-4
° 8 (Bias2)	--	638E-5	818E-4	519E-4	013E-4	294E-4	677E-4	641E-5	953E-4	380E-4	716E-4
° 9 (Bias2)	--	1.465E-4	263E-4	728E-4	940E-5	045E-5	366E-4	6.400E-6	4.430E-5	8.745E-5	329E-4
° 10 (Bias2)	--	638E-5	484E-4	425E-4	642E-4	570E-4	921E-4	265E-5	047E-4	7.311E-5	926E-4
° 11 (Bias2)	--	233E-4	706E-4	322E-4	877E-4	881E-5	062E-4	865E-5	417E-5	843E-5	883E-4
° 12 (OFF)	--	688E-5	603E-4	417E-4	173E-5	7.463E-5	8.412E-5	8.898E-5	450E-5	1.778E-4	581E-4
° 13 (OFF)	--	605E-5	854E-4	579E-4	058E-4	044E-5	010E-4	6.623E-5	498E-5	8.712E-5	714E-4
° 14 (OFF)	--	130E-5	176E-4	2.299E-5	282E-4	893E-5	438E-4	1.022E-4	748E-5	1.707E-4	059E-4
° 15 (OFF)	--	8.869E-5	467E-4	712E-5	153E-4	2.992E-5	649E-4	1.135E-4	7.303E-5	1.053E-4	872E-4
° 16 (OFF)	--	8.146E-6	139E-4	545E-4	035E-5	721E-5	835E-4	1.341E-5	308E-5	1.222E-4	349E-4
verage (Bias1)	--	330E-4	381E-4	229E-4	247E-5	087E-4	811E-4	715E-4	462E-4	727E-5	312E-4
(Bias1)	--	885E-5	208E-4	331E-5	817E-4	148E-4	292E-5	192E-4	188E-4	055E-4	012E-4
verage+3σ (Bias1)	--	295E-4	005E-4	128E-4	377E-4	532E-4	098E-4	290E-4	025E-4	839E-4	347E-4
verage-3σ (Bias1)	--	1.636E-4	1.242E-4	294E-5	527E-4	1.357E-4	233E-5	861E-4	1.100E-4	2.493E-4	7.228E-5
verage (Bias2)	--	949E-5	250E-4	958E-4	089E-4	493E-4	671E-4	677E-5	127E-5	6.780E-7	036E-4
(Bias2)	--	065E-4	389E-5	948E-5	135E-4	448E-5	250E-5	603E-5	595E-5	071E-5	078E-5
verage+3σ (Bias2)	--	590E-4	167E-4	142E-4	495E-4	427E-4	647E-4	049E-4	391E-4	715E-4	460E-4
verage-3σ (Bias2)	--	2.800E-4	335E-5	733E-5	2.316E-4	1.414E-5	963E-5	1.132E-5	1.766E-4	2.728E-4	1.131E-5
verage (OFF)	--	448E-5	048E-4	036E-4	427E-5	041E-5	518E-4	686E-5	140E-5	1.226E-4	715E-4
(OFF)	--	135E-5	498E-5	629E-5	226E-5	325E-5	080E-4	663E-5	761E-5	695E-5	713E-5
verage+3σ (OFF)	--	085E-4	697E-4	325E-4	910E-4	002E-4	757E-4	6974E-6	442E-4	822E-5	529E-4
verage-3σ (OFF)	--	1.596E-4	398E-4	1.252E-4	2.501E-6	1.793E-4	1.721E-4	1.667E-4	1.614E-4	2.935E-4	901E-4

11.K2-3

Ta = 25°C; IF = 2 mA ; Vdet = -15 V

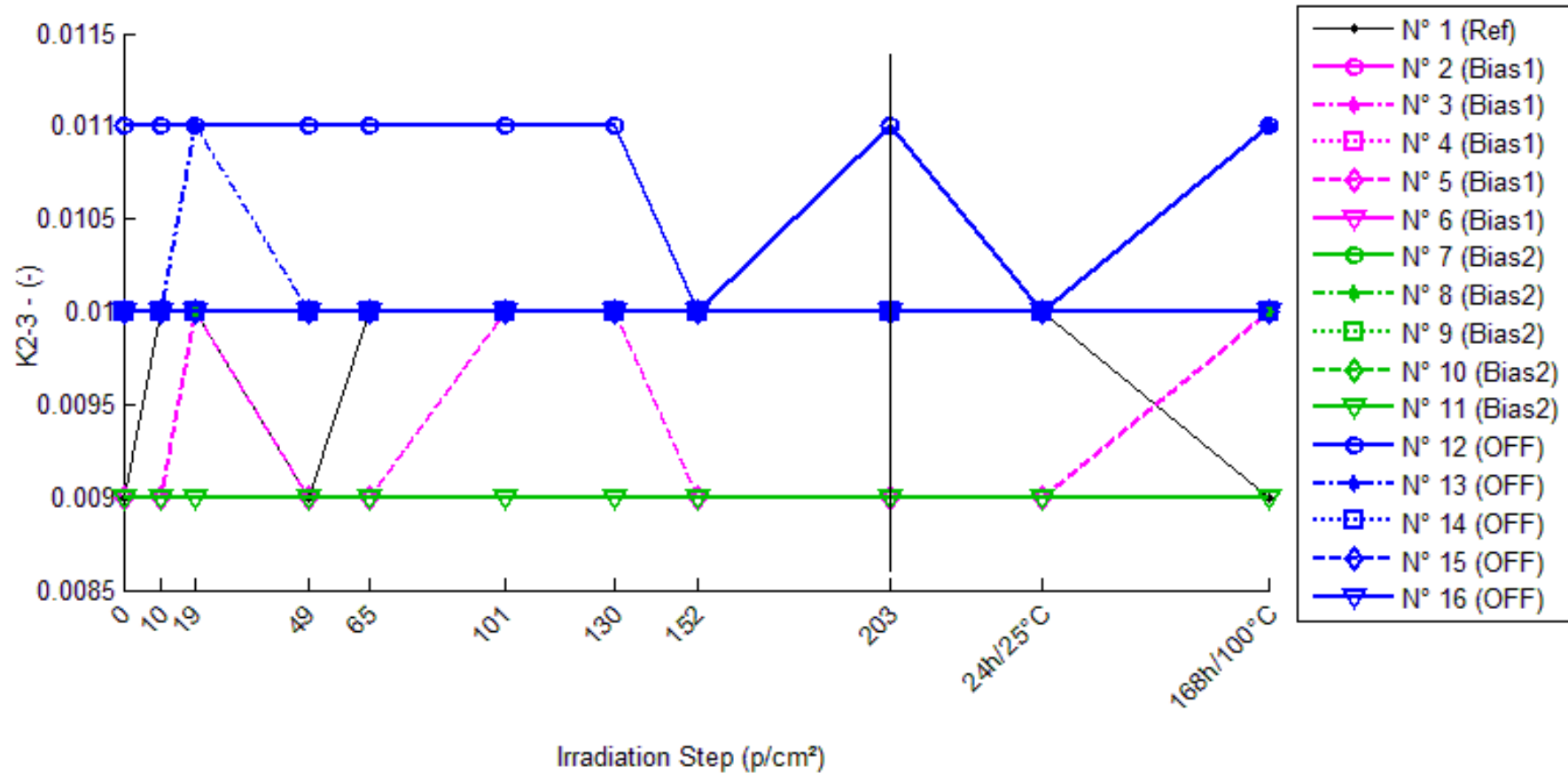

K2-3 . (-)

	0krad(Si)	10krad(Si)	19krad(Si)	49krad(Si)	65krad(Si)	101krad(Si)	130krad(Si)	152krad(Si)	203krad(Si)	24h/25°C	168h/100°C
N° 1 (Ref)	9.459E-3	9.502E-3	9.850E-3	9.355E-3	9.521E-3	9.581E-3	9.738E-3	9.672E-3	9.628E-3	9.502E-3	9.498E-3
N° 2 (Bias1)	9.692E-3	9.726E-3	9.812E-3	9.842E-3	9.556E-3	9.786E-3	9.872E-3	9.771E-3	9.737E-3	9.614E-3	9.785E-3
N° 3 (Bias1)	9.960E-3	1.005E-2	1.011E-2	1.011E-2	9.958E-3	9.997E-3	1.002E-2	9.993E-3	1.001E-2	9.903E-3	1.005E-2
N° 4 (Bias1)	9.843E-3	1.007E-2	1.020E-2	9.983E-3	1.011E-2	1.012E-2	9.979E-3	1.009E-2	1.013E-2	9.998E-3	1.013E-2
N° 5 (Bias1)	9.404E-3	9.458E-3	9.588E-3	9.482E-3	9.352E-3	9.592E-3	9.555E-3	9.413E-3	9.487E-3	9.378E-3	9.589E-3
N° 6 (Bias1)	9.800E-3	9.842E-3	9.984E-3	9.922E-3	9.840E-3	9.820E-3	9.855E-3	9.831E-3	9.893E-3	9.766E-3	9.915E-3
N° 7 (Bias2)	9.878E-3	9.941E-3	1.006E-2	1.001E-2	9.829E-3	1.004E-2	9.960E-3	9.868E-3	9.886E-3	9.829E-3	1.006E-2
N° 8 (Bias2)	1.013E-2	1.021E-2	1.037E-2	1.022E-2	1.026E-2	1.035E-2	1.023E-2	1.015E-2	1.023E-2	1.019E-2	1.034E-2
N° 9 (Bias2)	9.861E-3	9.781E-3	9.992E-3	9.976E-3	9.909E-3	9.973E-3	9.952E-3	9.848E-3	9.812E-3	9.768E-3	1.005E-2
N° 10 (Bias2)	9.742E-3	9.770E-3	9.921E-3	9.902E-3	9.826E-3	9.828E-3	9.868E-3	9.685E-3	9.751E-3	9.629E-3	1.001E-2
N° 11 (Bias2)	9.237E-3	9.299E-3	9.442E-3	9.390E-3	9.331E-3	9.246E-3	9.345E-3	9.198E-3	9.260E-3	9.175E-3	9.496E-3
N° 12 (OFF)	1.061E-2	1.066E-2	1.077E-2	1.070E-2	1.062E-2	1.051E-2	1.054E-2	1.048E-2	1.059E-2	1.041E-2	1.080E-2
N° 13 (OFF)	1.042E-2	1.044E-2	1.069E-2	1.049E-2	1.045E-2	1.036E-2	1.049E-2	1.029E-2	1.039E-2	1.029E-2	1.059E-2
N° 14 (OFF)	9.974E-3	1.000E-2	1.018E-2	9.937E-3	1.002E-2	9.943E-3	1.011E-2	9.841E-3	9.969E-3	9.790E-3	1.015E-2
N° 15 (OFF)	1.027E-2	1.024E-2	1.044E-2	1.029E-2	1.032E-2	1.019E-2	1.034E-2	1.011E-2	1.013E-2	1.009E-2	1.042E-2
N° 16 (OFF)	9.989E-3	9.974E-3	1.021E-2	1.009E-2	9.986E-3	1.002E-2	1.004E-2	9.865E-3	9.943E-3	9.813E-3	1.012E-2

Delta [K2-3]

	0krad(Si)	10krad(Si)	19krad(Si)	49krad(Si)	65krad(Si)	101krad(Si)	130krad(Si)	152krad(Si)	203krad(Si)	24h/25°C	168h/100°C
N° 1 (Ref)	---	4.276E-5	3.907E-4	-1.048E-4	6.169E-5	1.217E-4	2.783E-4	2.129E-4	1.682E-4	4.266E-5	3.831E-5
N° 2 (Bias1)	---	3.371E-5	1.203E-4	1.501E-4	-1.359E-4	9.442E-5	1.801E-4	7.856E-5	4.507E-5	-7.810E-5	9.340E-5
N° 3 (Bias1)	---	9.466E-5	1.453E-4	1.486E-4	-1.990E-6	3.703E-5	6.184E-5	3.279E-5	5.142E-5	-5.711E-5	9.019E-5
N° 4 (Bias1)	---	2.303E-4	3.534E-4	1.395E-4	2.715E-4	2.769E-4	1.360E-4	2.419E-4	2.894E-4	1.548E-4	2.898E-4
N° 5 (Bias1)	---	5.475E-5	1.845E-4	7.860E-5	-5.125E-5	1.886E-4	1.510E-4	9.350E-6	8.339E-5	-2.537E-5	1.854E-4
N° 6 (Bias1)	---	4.178E-5	1.844E-4	1.225E-4	4.006E-5	2.051E-5	5.561E-5	3.110E-5	9.273E-5	-3.345E-5	1.150E-4
N° 7 (Bias2)	---	6.248E-5	1.773E-4	1.359E-4	-4.909E-5	1.632E-4	8.152E-5	-9.990E-6	8.070E-6	-4.968E-5	1.834E-4
N° 8 (Bias2)	---	7.740E-5	2.334E-4	8.317E-5	1.294E-4	2.166E-4	9.871E-5	1.840E-5	9.222E-5	5.371E-5	2.036E-4
N° 9 (Bias2)	---	-8.036E-5	1.308E-4	1.148E-4	4.803E-5	1.123E-4	9.088E-5	-1.338E-5	-4.885E-5	-9.317E-5	1.857E-4
N° 10 (Bias2)	---	2.773E-5	1.790E-4	1.598E-4	8.379E-5	8.595E-5	1.252E-4	-5.716E-5	8.330E-6	-1.129E-4	2.630E-4
N° 11 (Bias2)	---	6.186E-5	2.050E-4	1.531E-4	9.417E-5	9.255E-6	1.085E-4	-3.897E-5	2.295E-5	-6.125E-5	2.597E-4
N° 12 (OFF)	---	4.990E-5	1.635E-4	8.427E-5	7.610E-6	-9.987E-5	-6.690E-5	-1.268E-4	-1.638E-5	-2.058E-4	1.843E-4
N° 13 (OFF)	---	2.769E-5	2.714E-4	7.723E-5	3.032E-5	-5.664E-5	7.300E-5	-1.262E-4	-2.317E-5	-1.271E-4	1.794E-4
N° 14 (OFF)	---	2.754E-5	2.053E-4	-3.702E-5	5.139E-5	-3.102E-5	1.393E-4	-1.325E-4	-4.745E-6	-1.832E-4	1.809E-4
N° 15 (OFF)	---	-3.040E-5	1.782E-4	2.869E-5	5.631E-5	-8.019E-5	7.454E-5	-1.541E-4	-1.343E-4	-1.761E-4	1.567E-4
N° 16 (OFF)	---	-1.474E-5	2.177E-4	9.768E-5	-2.690E-6	3.422E-5	5.333E-5	-1.238E-4	-4.571E-5	-1.755E-4	1.269E-4
Average (Bias1)	---	9.103E-5	1.976E-4	1.279E-4	2.447E-5	1.235E-4	1.169E-4	7.874E-5	1.124E-4	-7.844E-6	1.548E-4
σ (Bias1)	---	8.128E-5	9.127E-5	2.965E-5	1.528E-4	1.080E-4	5.548E-5	9.463E-5	1.010E-4	9.324E-5	8.468E-5
Average+3σ (Bias1)	---	3.349E-4	4.714E-4	2.168E-4	4.829E-4	4.476E-4	2.834E-4	3.626E-4	4.155E-4	2.719E-4	4.088E-4
Average-3σ (Bias1)	---	-1.528E-4	-7.624E-5	3.891E-5	-4.340E-4	-2.006E-4	-4.953E-5	-2.052E-4	-1.907E-4	-2.876E-4	-9.930E-5
Average (Bias2)	---	2.982E-5	1.851E-4	1.293E-4	6.125E-5	1.175E-4	1.010E-4	-2.022E-5	1.654E-5	-5.265E-5	2.191E-4
σ (Bias2)	---	6.423E-5	3.797E-5	3.114E-5	6.815E-5	7.851E-5	1.681E-5	2.898E-5	5.046E-5	6.454E-5	3.940E-5
Average+3σ (Bias2)	---	2.225E-4	2.990E-4	2.228E-4	2.657E-4	3.530E-4	1.514E-4	6.671E-5	1.679E-4	1.410E-4	3.373E-4
Average-3σ (Bias2)	---	-1.629E-4	7.118E-5	3.593E-5	-1.432E-4	-1.181E-4	5.055E-5	-1.072E-4	-1.348E-4	-2.463E-4	1.009E-4
Average (OFF)	---	1.200E-5	2.072E-4	5.017E-5	2.859E-5	-4.670E-5	5.465E-5	-1.327E-4	-4.486E-5	-1.735E-4	1.656E-4
σ (OFF)	---	3.330E-5	4.177E-5	5.526E-5	2.603E-5	5.206E-5	7.528E-5	1.240E-5	5.217E-5	2.876E-5	2.425E-5
Average+3σ (OFF)	---	1.119E-4	3.325E-4	2.160E-4	1.067E-4	1.095E-4	2.805E-4	-9.549E-5	1.117E-4	-8.727E-5	2.384E-4
Average-3σ (OFF)	---	-8.791E-5	8.189E-5	-1.156E-4	-4.950E-5	-2.029E-4	-1.712E-4	-1.699E-4	-2.014E-4	-2.598E-4	9.289E-5

12.K2-4

Ta = 25°C; IF = 60 mA ; Vdet = -15 V

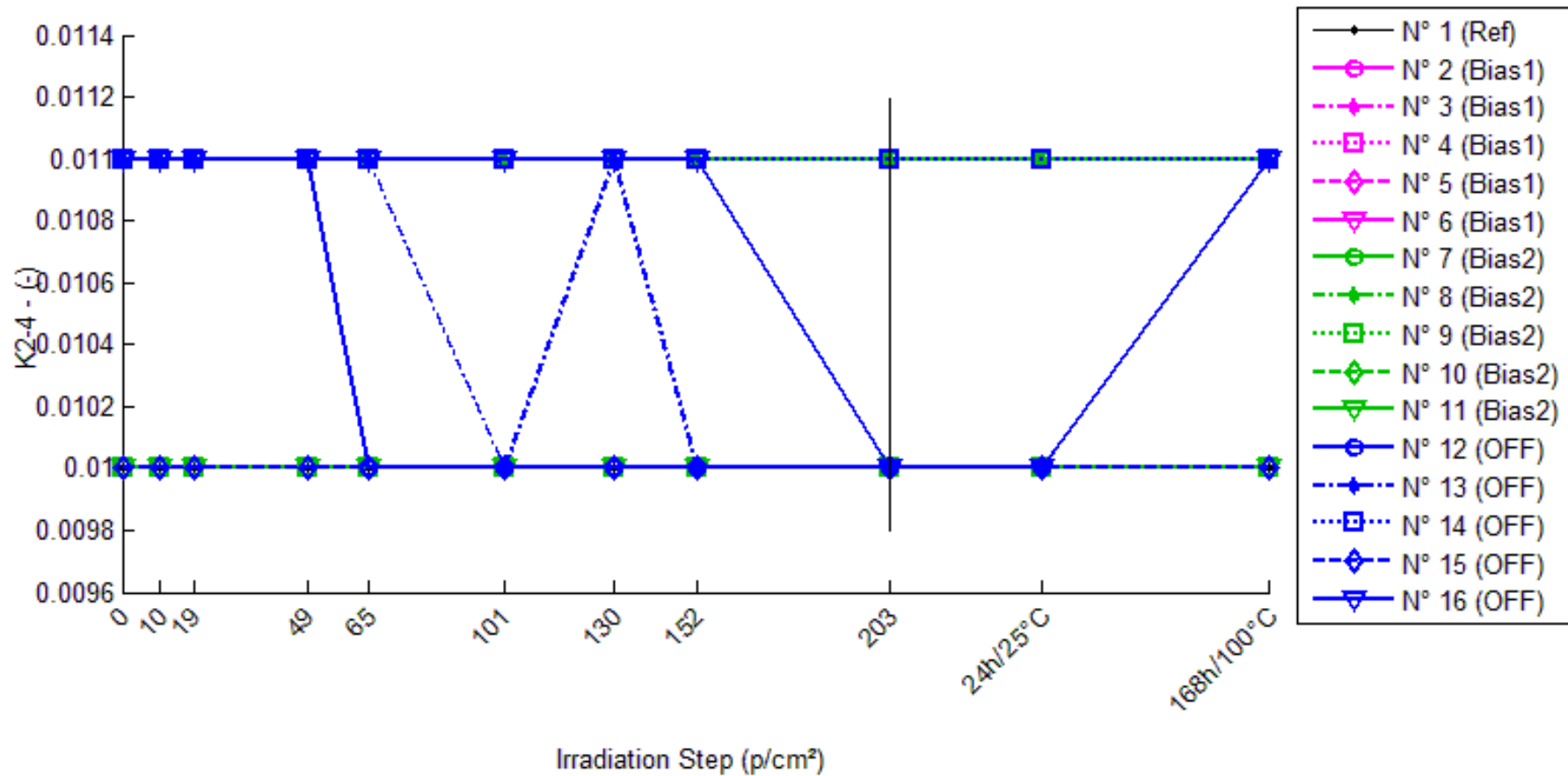

K2-4 . (-)

	0krad(Si)	10krad(Si)	19krad(Si)	49krad(Si)	65krad(Si)	101krad(Si)	130krad(Si)	152krad(Si)	203krad(Si)	24h/25°C	168h/100°C
N° 1 (Ref)	1.003E-2	1.009E-2	1.018E-2	9.948E-3	1.007E-2	1.011E-2	1.021E-2	1.013E-2	1.009E-2	1.003E-2	1.008E-2
N° 2 (Bias1)	9.924E-3	9.949E-3	1.002E-2	9.821E-3	9.756E-3	9.808E-3	9.962E-3	9.781E-3	9.740E-3	9.719E-3	9.936E-3
N° 3 (Bias1)	1.082E-2	1.082E-2	1.093E-2	1.075E-2	1.069E-2	1.068E-2	1.072E-2	1.066E-2	1.064E-2	1.062E-2	1.082E-2
N° 4 (Bias1)	1.073E-2	1.077E-2	1.085E-2	1.069E-2	1.068E-2	1.076E-2	1.067E-2	1.064E-2	1.063E-2	1.060E-2	1.078E-2
N° 5 (Bias1)	9.917E-3	9.923E-3	1.001E-2	9.894E-3	9.816E-3	9.954E-3	9.904E-3	9.789E-3	9.776E-3	9.747E-3	9.946E-3
N° 6 (Bias1)	1.038E-2	1.038E-2	1.046E-2	1.036E-2	1.031E-2	1.033E-2	1.031E-2	1.026E-2	1.024E-2	1.021E-2	1.039E-2
N° 7 (Bias2)	1.078E-2	1.076E-2	1.084E-2	1.073E-2	1.066E-2	1.078E-2	1.065E-2	1.060E-2	1.057E-2	1.055E-2	1.080E-2
N° 8 (Bias2)	1.099E-2	1.098E-2	1.107E-2	1.094E-2	1.093E-2	1.101E-2	1.087E-2	1.082E-2	1.080E-2	1.077E-2	1.101E-2
N° 9 (Bias2)	1.043E-2	1.037E-2	1.048E-2	1.039E-2	1.036E-2	1.041E-2	1.032E-2	1.026E-2	1.023E-2	1.020E-2	1.045E-2
N° 10 (Bias2)	1.042E-2	1.035E-2	1.045E-2	1.035E-2	1.031E-2	1.033E-2	1.029E-2	1.020E-2	1.019E-2	1.014E-2	1.042E-2
N° 11 (Bias2)	1.019E-2	1.016E-2	1.025E-2	1.014E-2	1.009E-2	1.004E-2	1.007E-2	9.992E-3	9.981E-3	9.943E-3	1.021E-2
N° 12 (OFF)	1.058E-2	1.066E-2	1.066E-2	1.055E-2	1.049E-2	1.042E-2	1.044E-2	1.039E-2	1.037E-2	1.032E-2	1.061E-2
N° 13 (OFF)	1.064E-2	1.062E-2	1.077E-2	1.061E-2	1.056E-2	1.049E-2	1.052E-2	1.044E-2	1.042E-2	1.038E-2	1.066E-2
N° 14 (OFF)	1.078E-2	1.076E-2	1.086E-2	1.073E-2	1.070E-2	1.063E-2	1.068E-2	1.058E-2	1.058E-2	1.051E-2	1.081E-2
N° 15 (OFF)	1.036E-2	1.032E-2	1.042E-2	1.033E-2	1.028E-2	1.020E-2	1.027E-2	1.015E-2	1.012E-2	1.009E-2	1.037E-2
N° 16 (OFF)	1.071E-2	1.068E-2	1.079E-2	1.068E-2	1.064E-2	1.063E-2	1.060E-2	1.050E-2	1.049E-2	1.044E-2	1.071E-2

Delta [K2-4]

	0krad(Si)	10krad(Si)	19krad(Si)	49krad(Si)	65krad(Si)	101krad(Si)	130krad(Si)	152krad(Si)	203krad(Si)	24h/25°C	168h/100°C
N° 1 (Ref)	---	5.175E-5	1.434E-4	-8.540E-5	3.310E-5	8.012E-5	1.750E-4	1.004E-4	5.767E-5	-4.490E-6	4.589E-5
N° 2 (Bias1)	---	2.468E-5	9.516E-5	-1.037E-4	-1.682E-4	-1.168E-4	3.799E-5	-1.435E-4	-1.846E-4	-2.049E-4	1.193E-5
N° 3 (Bias1)	---	-5.800E-7	1.095E-4	-7.441E-5	-1.305E-4	-1.409E-4	-1.046E-4	-1.615E-4	-1.816E-4	-2.034E-4	1.200E-7
N° 4 (Bias1)	---	3.602E-5	1.229E-4	-3.633E-5	-4.797E-5	2.431E-5	-6.329E-5	-9.094E-5	-1.017E-4	-1.354E-4	4.742E-5
N° 5 (Bias1)	---	6.168E-6	9.743E-5	-2.232E-5	-1.005E-4	3.696E-5	-1.298E-5	-1.278E-4	-1.408E-4	-1.698E-4	2.905E-5
N° 6 (Bias1)	---	-2.930E-6	8.019E-5	-1.977E-5	-7.593E-5	-5.646E-5	-7.419E-5	-1.233E-4	-1.428E-4	-1.681E-4	2.620E-6
N° 7 (Bias2)	---	-1.974E-5	6.260E-5	-5.292E-5	-1.207E-4	-6.320E-6	-1.311E-4	-1.784E-4	-2.131E-4	-2.354E-4	1.384E-5
N° 8 (Bias2)	---	-1.471E-5	7.616E-5	-5.162E-5	-6.198E-5	1.783E-5	-1.265E-4	-1.734E-4	-1.963E-4	-2.210E-4	1.705E-5
N° 9 (Bias2)	---	-5.658E-5	5.589E-5	-3.616E-5	-6.389E-5	-1.975E-5	-1.037E-4	-1.718E-4	-1.950E-4	-2.245E-4	1.900E-5
N° 10 (Bias2)	---	-6.730E-5	2.708E-5	-6.758E-5	-1.118E-4	-9.534E-5	-1.347E-4	-2.182E-4	-2.266E-4	-2.764E-4	3.010E-6
N° 11 (Bias2)	---	-2.161E-5	6.270E-5	-4.184E-5	-9.913E-5	-1.496E-4	-1.187E-4	-1.935E-4	-2.041E-4	-2.423E-4	2.521E-5
N° 12 (OFF)	---	-2.562E-5	7.052E-5	-3.656E-5	-9.539E-5	-1.683E-4	-1.452E-4	-1.997E-4	-2.112E-4	-2.627E-4	2.271E-5
N° 13 (OFF)	---	-1.360E-5	1.333E-4	-2.949E-5	-7.953E-5	-1.477E-4	-1.104E-4	-1.964E-4	-2.120E-4	-2.537E-4	2.357E-5
N° 14 (OFF)	---	-2.866E-5	8.006E-5	-5.102E-5	-8.665E-5	-1.533E-4	-1.016E-4	-2.034E-4	-2.058E-4	-2.762E-4	2.222E-5
N° 15 (OFF)	---	-4.081E-5	5.880E-5	-3.150E-5	-7.602E-5	-1.628E-4	-9.142E-5	-2.116E-4	-2.392E-4	-2.687E-4	1.427E-5
N° 16 (OFF)	---	-2.511E-5	8.446E-5	-2.284E-5	-6.591E-5	-8.017E-5	-1.109E-4	-2.042E-4	-2.174E-4	-2.670E-4	6.600E-6
Average (Bias1)	---	1.267E-5	1.010E-4	-5.131E-5	-1.046E-4	-5.059E-5	-4.341E-5	-1.294E-4	-1.503E-4	-1.764E-4	1.823E-5
σ (Bias1)	---	1.696E-5	1.608E-5	3.655E-5	4.680E-5	8.040E-5	5.621E-5	2.620E-5	3.416E-5	2.887E-5	1.988E-5
Average+3σ (Bias1)	---	6.356E-5	1.493E-4	5.833E-5	3.579E-5	1.906E-4	1.252E-4	-5.081E-5	-4.781E-5	-8.975E-5	7.786E-5
Average-3σ (Bias1)	---	-3.821E-5	5.281E-5	-1.610E-4	-2.450E-4	-2.918E-4	-2.121E-4	-2.080E-4	-2.528E-4	-2.630E-4	-4.140E-5
Average (Bias2)	---	-3.599E-5	5.689E-5	-5.002E-5	-9.150E-5	-5.064E-5	-1.229E-4	-1.871E-4	-2.070E-4	-2.399E-4	1.562E-5
σ (Bias2)	---	2.412E-5	1.822E-5	1.202E-5	2.719E-5	6.964E-5	1.229E-5	1.942E-5	1.312E-5	2.212E-5	8.180E-6
Average+3σ (Bias2)	---	3.639E-5	1.115E-4	-1.395E-5	-9.932E-6	1.583E-4	-8.606E-5	-1.288E-4	-1.677E-4	-1.736E-4	4.016E-5
Average-3σ (Bias2)	---	-1.084E-4	2.237E-6	-8.610E-5	-1.731E-4	-2.595E-4	-1.598E-4	-2.453E-4	-2.464E-4	-3.063E-4	-8.917E-6
Average (OFF)	---	-2.676E-5	8.544E-5	-3.428E-5	-8.070E-5	-1.425E-4	-1.119E-4	-2.030E-4	-2.171E-4	-2.657E-4	1.787E-5
σ (OFF)	---	9.724E-6	2.853E-5	1.057E-5	1.110E-5	3.574E-5	2.026E-5	5.706E-6	1.299E-5	8.293E-6	7.328E-6
Average+3σ (OFF)	---	2.412E-6	1.710E-4	-2.569E-6	-4.739E-5	-3.525E-5	-5.114E-5	-1.859E-4	-1.781E-4	-2.408E-4	3.986E-5
Average-3σ (OFF)	---	-5.593E-5	-1.641E-7	-6.599E-5	-1.140E-4	-2.497E-4	-1.727E-4	-2.202E-4	-2.561E-4	-2.905E-4	-4.111E-6

13.K2-5

Ta = 25°C; IF = 10 mA ; Vdet = -30 V

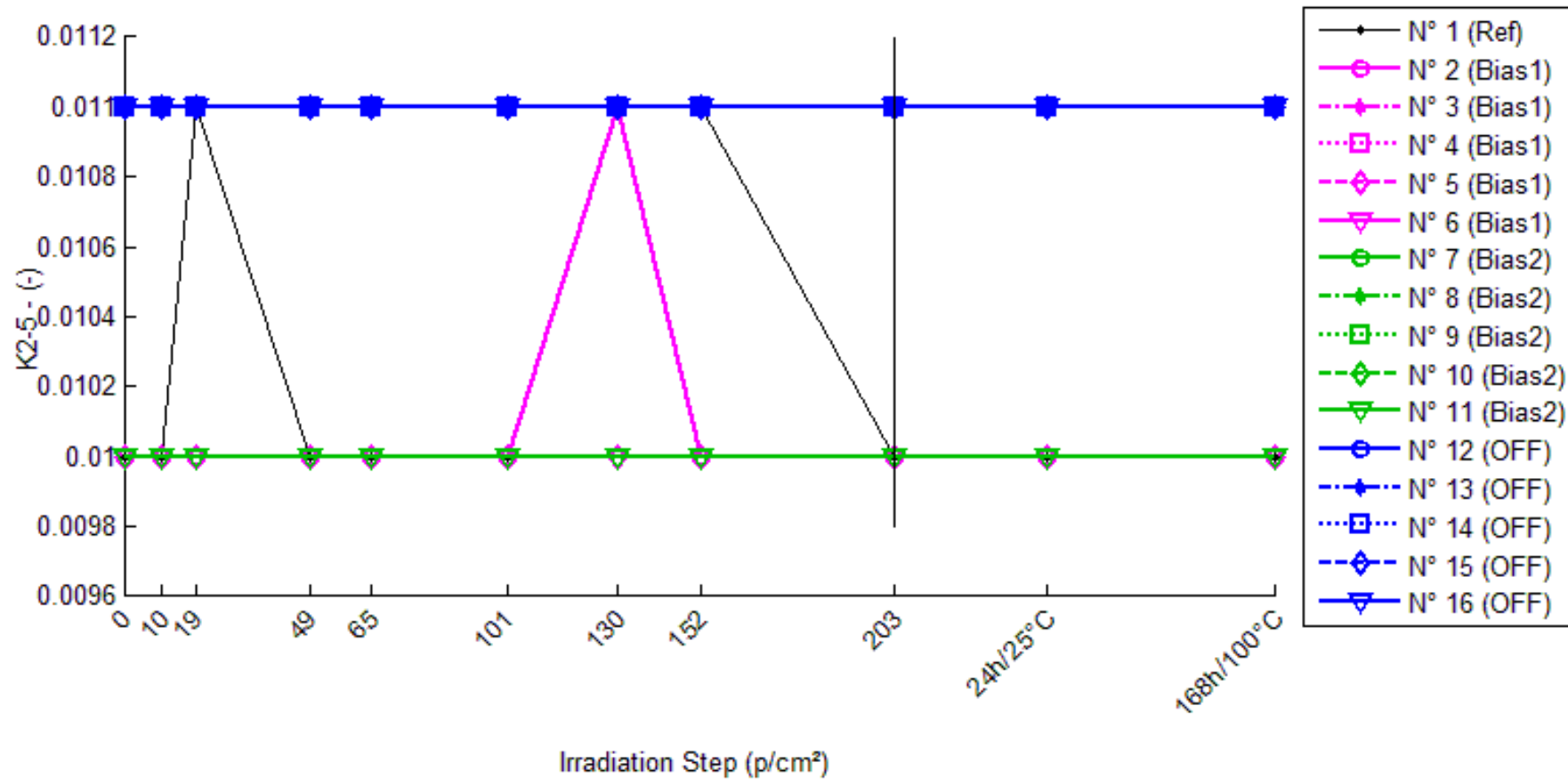

K2-5 . (-)

	0krad(Si)	10krad(Si)	19krad(Si)	49krad(Si)	65krad(Si)	101krad(Si)	130krad(Si)	152krad(Si)	203krad(Si)	24h/25°C	168h/100°C
N° 1 (Ref)	1.037E-2	1.043E-2	1.058E-2	1.027E-2	1.041E-2	1.047E-2	1.058E-2	1.051E-2	1.046E-2	1.037E-2	1.042E-2
N° 2 (Bias1)	1.035E-2	1.040E-2	1.045E-2	1.034E-2	1.022E-2	1.033E-2	1.052E-2	1.030E-2	1.026E-2	1.020E-2	1.038E-2
N° 3 (Bias1)	1.106E-2	1.110E-2	1.119E-2	1.107E-2	1.099E-2	1.100E-2	1.104E-2	1.099E-2	1.097E-2	1.092E-2	1.109E-2
N° 4 (Bias1)	1.106E-2	1.117E-2	1.125E-2	1.109E-2	1.113E-2	1.121E-2	1.109E-2	1.111E-2	1.110E-2	1.103E-2	1.117E-2
N° 5 (Bias1)	1.025E-2	1.029E-2	1.039E-2	1.028E-2	1.019E-2	1.042E-2	1.033E-2	1.019E-2	1.020E-2	1.015E-2	1.032E-2
N° 6 (Bias1)	1.072E-2	1.075E-2	1.083E-2	1.077E-2	1.071E-2	1.073E-2	1.073E-2	1.068E-2	1.068E-2	1.063E-2	1.076E-2
N° 7 (Bias2)	1.100E-2	1.103E-2	1.111E-2	1.103E-2	1.095E-2	1.117E-2	1.101E-2	1.096E-2	1.094E-2	1.090E-2	1.109E-2
N° 8 (Bias2)	1.125E-2	1.129E-2	1.138E-2	1.128E-2	1.128E-2	1.145E-2	1.126E-2	1.122E-2	1.122E-2	1.118E-2	1.134E-2
N° 9 (Bias2)	1.081E-2	1.078E-2	1.090E-2	1.086E-2	1.083E-2	1.091E-2	1.085E-2	1.077E-2	1.075E-2	1.071E-2	1.091E-2
N° 10 (Bias2)	1.079E-2	1.077E-2	1.087E-2	1.083E-2	1.079E-2	1.083E-2	1.081E-2	1.070E-2	1.073E-2	1.064E-2	1.090E-2
N° 11 (Bias2)	1.038E-2	1.040E-2	1.050E-2	1.043E-2	1.038E-2	1.034E-2	1.040E-2	1.031E-2	1.032E-2	1.026E-2	1.050E-2
N° 12 (OFF)	1.113E-2	1.113E-2	1.124E-2	1.115E-2	1.111E-2	1.105E-2	1.109E-2	1.104E-2	1.105E-2	1.096E-2	1.120E-2
N° 13 (OFF)	1.114E-2	1.115E-2	1.132E-2	1.116E-2	1.112E-2	1.108E-2	1.115E-2	1.104E-2	1.106E-2	1.100E-2	1.121E-2
N° 14 (OFF)	1.113E-2	1.113E-2	1.126E-2	1.111E-2	1.111E-2	1.107E-2	1.117E-2	1.102E-2	1.107E-2	1.095E-2	1.120E-2
N° 15 (OFF)	1.089E-2	1.085E-2	1.098E-2	1.089E-2	1.087E-2	1.080E-2	1.091E-2	1.077E-2	1.076E-2	1.072E-2	1.094E-2
N° 16 (OFF)	1.105E-2	1.104E-2	1.118E-2	1.108E-2	1.104E-2	1.107E-2	1.107E-2	1.096E-2	1.096E-2	1.089E-2	1.110E-2

Delta [K2-5]

	0krad(Si)	10krad(Si)	19krad(Si)	49krad(Si)	65krad(Si)	101krad(Si)	130krad(Si)	152krad(Si)	203krad(Si)	24h/25°C	168h/100°C
N° 1 (Ref)	---	5.671E-5	2.073E-4	-9.839E-5	3.678E-5	9.831E-5	2.087E-4	1.346E-4	8.483E-5	-1.020E-6	4.467E-5
N° 2 (Bias1)	---	4.377E-5	9.902E-5	-1.275E-5	-1.351E-4	-2.671E-5	1.671E-4	-5.177E-5	-9.487E-5	-1.486E-4	3.033E-5
N° 3 (Bias1)	---	3.626E-5	1.281E-4	6.160E-6	-6.869E-5	-6.249E-5	-2.295E-5	-7.507E-5	-8.899E-5	-1.398E-4	2.349E-5
N° 4 (Bias1)	---	1.047E-4	1.893E-4	3.000E-5	7.107E-5	1.485E-4	3.319E-5	4.494E-5	4.059E-5	-2.704E-5	1.132E-4
N° 5 (Bias1)	---	4.102E-5	1.424E-4	2.648E-5	-6.330E-5	1.644E-4	8.183E-5	-6.015E-5	-5.017E-5	-1.066E-4	7.204E-5
N° 6 (Bias1)	---	2.869E-5	1.097E-4	4.469E-5	-1.591E-5	5.490E-6	3.370E-6	-3.921E-5	-3.988E-5	-9.309E-5	3.948E-5
N° 7 (Bias2)	---	3.036E-5	1.079E-4	3.192E-5	-4.915E-5	1.721E-4	7.430E-6	-4.172E-5	-5.861E-5	-9.975E-5	8.819E-5
N° 8 (Bias2)	---	3.962E-5	1.301E-4	2.725E-5	3.277E-5	2.046E-4	1.648E-5	-2.709E-5	-2.654E-5	-6.450E-5	9.528E-5
N° 9 (Bias2)	---	-2.528E-5	9.343E-5	4.982E-5	1.938E-5	1.049E-4	3.629E-5	-3.867E-5	-5.590E-5	-1.011E-4	9.616E-5
N° 10 (Bias2)	---	-1.950E-5	7.889E-5	3.353E-5	-3.370E-6	3.450E-5	1.929E-5	-8.963E-5	-6.914E-5	-1.521E-4	1.080E-4
N° 11 (Bias2)	---	2.829E-5	1.210E-4	5.388E-5	1.700E-6	-3.748E-5	2.521E-5	-6.724E-5	-5.623E-5	-1.137E-4	1.203E-4
N° 12 (OFF)	---	1.620E-6	1.058E-4	2.046E-5	-2.029E-5	-8.145E-5	-4.099E-5	-9.131E-5	-7.809E-5	-1.699E-4	7.034E-5
N° 13 (OFF)	---	1.345E-5	1.822E-4	2.085E-5	-1.674E-5	-6.117E-5	1.379E-5	-1.026E-4	-7.609E-5	-1.415E-4	7.053E-5
N° 14 (OFF)	---	-3.310E-6	1.283E-4	-2.519E-5	-2.413E-5	-6.551E-5	3.438E-5	-1.150E-4	-6.714E-5	-1.805E-4	6.898E-5
N° 15 (OFF)	---	-3.123E-5	9.356E-5	5.260E-6	-1.201E-5	-8.270E-5	2.750E-5	-1.180E-4	-1.289E-4	-1.664E-4	5.715E-5
N° 16 (OFF)	---	-1.609E-5	1.298E-4	3.143E-5	-8.270E-6	1.526E-5	1.603E-5	-9.390E-5	-8.951E-5	-1.675E-4	4.543E-5
Average (Bias1)	---	5.090E-5	1.337E-4	1.892E-5	-4.238E-5	4.583E-5	5.251E-5	-3.625E-5	-4.666E-5	-1.030E-4	5.570E-5
σ (Bias1)	---	3.064E-5	3.526E-5	2.242E-5	7.630E-5	1.039E-4	7.497E-5	4.722E-5	5.428E-5	4.826E-5	3.712E-5
Average+3σ (Bias1)	---	1.428E-4	2.395E-4	8.616E-5	1.865E-4	3.576E-4	2.774E-4	1.054E-4	1.162E-4	4.175E-5	1.671E-4
Average-3σ (Bias1)	---	-4.102E-5	2.789E-5	-4.833E-5	-2.713E-4	-2.660E-4	-1.724E-4	-1.779E-4	-2.095E-4	-2.478E-4	-5.567E-5
Average (Bias2)	---	1.070E-5	1.063E-4	3.928E-5	2.660E-7	9.573E-5	2.094E-5	-5.287E-5	-5.328E-5	-1.062E-4	1.016E-4
σ (Bias2)	---	3.057E-5	2.061E-5	1.179E-5	3.114E-5	9.908E-5	1.071E-5	2.524E-5	1.589E-5	3.151E-5	1.267E-5
Average+3σ (Bias2)	---	1.024E-4	1.681E-4	7.466E-5	9.369E-5	3.930E-4	5.308E-5	2.285E-5	-5.600E-6	-1.170E-5	1.396E-4
Average-3σ (Bias2)	---	-8.102E-5	4.441E-5	3.904E-6	-9.316E-5	-2.015E-4	-1.120E-5	-1.286E-4	-1.010E-4	-2.008E-4	6.359E-5
Average (OFF)	---	-7.112E-6	1.279E-4	1.056E-5	-1.629E-5	-5.511E-5	1.014E-5	-1.042E-4	-8.795E-5	-1.652E-4	6.249E-5
σ (OFF)	---	1.714E-5	3.397E-5	2.205E-5	6.331E-6	4.047E-5	2.980E-5	1.207E-5	2.425E-5	1.437E-5	1.104E-5
Average+3σ (OFF)	---	4.432E-5	2.298E-4	7.673E-5	2.704E-6	6.630E-5	9.953E-5	-6.798E-5	-1.519E-5	-1.220E-4	9.562E-5
Average-3σ (OFF)	---	-5.855E-5	2.600E-5	-5.560E-5	-3.528E-5	-1.765E-4	-7.925E-5	-1.404E-4	-1.607E-4	-2.083E-4	2.935E-5

14.Ip2

Ta = 25°C; IF = 10 mA ; Vdet = -15 V

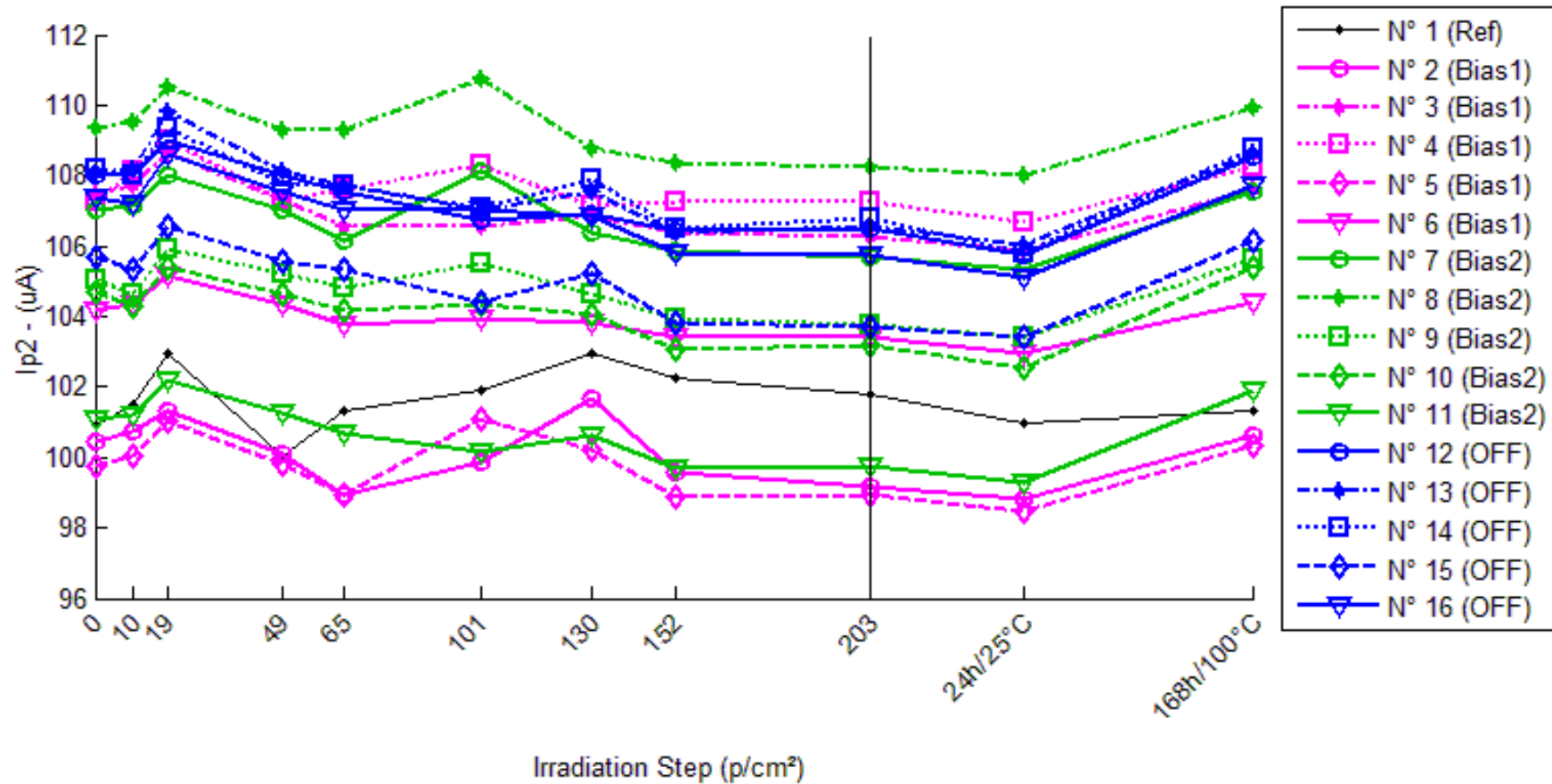

Ip2 . (uA)

	0krad(Si)	10krad(Si)	19krad(Si)	49krad(Si)	65krad(Si)	101krad(Si)	130krad(Si)	152krad(Si)	203krad(Si)	24h/25°C	168h/100°C
N° 1 (Ref)	100.942	101.496	102.944	100.019	101.310	101.932	102.947	102.256	101.769	100.947	101.349
N° 2 (Bias1)	100.426	100.751	101.322	100.073	98.922	99.857	101.658	99.556	99.169	98.805	100.627
N° 3 (Bias1)	107.467	107.714	108.667	107.297	106.543	106.560	106.870	106.388	106.281	105.857	107.618
N° 4 (Bias1)	107.278	108.139	109.001	107.316	107.605	108.323	107.148	107.258	107.260	106.679	108.221
N° 5 (Bias1)	99.755	100.032	101.030	99.817	98.918	101.083	100.199	98.852	98.959	98.470	100.335
N° 6 (Bias1)	104.153	104.325	105.167	104.367	103.761	103.926	103.803	103.397	103.404	102.977	104.415
N° 7 (Bias2)	107.024	107.114	107.992	107.011	106.152	108.111	106.387	105.876	105.678	105.341	107.557
N° 8 (Bias2)	109.352	109.522	110.544	109.305	109.274	110.745	108.794	108.343	108.272	108.000	109.924
N° 9 (Bias2)	105.064	104.623	105.922	105.209	104.840	105.499	104.669	103.949	103.746	103.409	105.626
N° 10 (Bias2)	104.693	104.294	105.376	104.623	104.195	104.362	104.076	103.062	103.201	102.517	105.370
N° 11 (Bias2)	101.116	101.191	102.190	101.246	100.672	100.140	100.621	99.705	99.780	99.289	101.901
N° 12 (OFF)	108.029	108.011	108.998	108.016	107.528	106.735	106.924	106.415	106.508	105.756	108.555
N° 13 (OFF)	108.073	108.176	109.801	108.154	107.706	107.031	107.565	106.410	106.573	106.043	108.628
N° 14 (OFF)	108.192	108.001	109.379	107.810	107.724	107.111	107.918	106.481	106.784	105.820	108.771
N° 15 (OFF)	105.705	105.359	106.579	105.594	105.331	104.406	105.241	103.824	103.708	103.402	106.166
N° 16 (OFF)	107.381	107.210	108.613	107.522	107.054	107.050	106.852	105.787	105.762	105.121	107.725

Delta [Ip2]

	0krad(Si)	10krad(Si)	19krad(Si)	49krad(Si)	65krad(Si)	101krad(Si)	130krad(Si)	152krad(Si)	203krad(Si)	24h/25°C	168h/100°C
N° 1 (Ref)	---	5.544E-1	2.002E+0	-9.227E-1	3.685E-1	9.900E-1	2.005E+0	1.314E+0	8.276E-1	4.700E-3	4.074E-1
N° 2 (Bias1)	---	3.254E-1	8.956E-1	-3.526E-1	-1.504E+0	-5.694E-1	1.232E+0	-8.699E-1	-1.257E+0	-1.621E+0	2.007E-1
N° 3 (Bias1)	---	2.466E-1	1.200E+0	-1.698E-1	-9.244E-1	-9.073E-1	-5.972E-1	-1.079E+0	-1.187E+0	-1.610E+0	1.510E-1
N° 4 (Bias1)	---	8.617E-1	1.724E+0	3.790E-2	3.268E-1	1.045E+0	-1.296E-1	-1.980E-2	-1.760E-2	-5.989E-1	9.434E-1
N° 5 (Bias1)	---	2.776E-1	1.275E+0	6.205E-2	-8.362E-1	1.329E+0	4.445E-1	-9.024E-1	-7.955E-1	-1.285E+0	5.808E-1
N° 6 (Bias1)	---	1.716E-1	1.013E+0	2.141E-1	-3.923E-1	-2.269E-1	-3.499E-1	-7.565E-1	-7.491E-1	-1.176E+0	2.614E-1
N° 7 (Bias2)	---	8.990E-2	9.678E-1	-1.370E-2	-8.720E-1	1.087E+0	-6.370E-1	-1.148E+0	-1.346E+0	-1.683E+0	5.330E-1
N° 8 (Bias2)	---	1.700E-1	1.192E+0	-4.710E-2	-7.730E-2	1.394E+0	-5.572E-1	-1.008E+0	-1.080E+0	-1.352E+0	5.720E-1
N° 9 (Bias2)	---	-4.405E-1	8.588E-1	1.452E-1	-2.235E-1	4.352E-1	-3.944E-1	-1.114E+0	-1.318E+0	-1.655E+0	5.624E-1
N° 10 (Bias2)	---	-3.992E-1	6.830E-1	-6.990E-2	-4.982E-1	-3.311E-1	-6.171E-1	-1.631E+0	-1.492E+0	-2.176E+0	6.773E-1
N° 11 (Bias2)	---	7.500E-2	1.074E+0	1.303E-1	-4.442E-1	-9.759E-1	-4.950E-1	-1.411E+0	-1.336E+0	-1.827E+0	7.846E-1
N° 12 (OFF)	---	-1.840E-2	9.685E-1	-1.330E-2	-5.011E-1	-1.295E+0	-1.106E+0	-1.614E+0	-1.521E+0	-2.273E+0	5.262E-1
N° 13 (OFF)	---	1.025E-1	1.728E+0	8.050E-2	-3.676E-1	-1.042E+0	-5.082E-1	-1.663E+0	-1.500E+0	-2.031E+0	5.552E-1
N° 14 (OFF)	---	-1.914E-1	1.187E+0	-3.819E-1	-4.684E-1	-1.081E+0	-2.746E-1	-1.711E+0	-1.408E+0	-2.373E+0	5.788E-1
N° 15 (OFF)	---	-3.461E-1	8.732E-1	-1.109E-1	-3.745E-1	-1.299E+0	-4.639E-1	-1.881E+0	-1.997E+0	-2.304E+0	4.606E-1
N° 16 (OFF)	---	-1.708E-1	1.232E+0	1.413E-1	-3.268E-1	-3.308E-1	-5.288E-1	-1.593E+0	-1.619E+0	-2.260E+0	3.440E-1
Average (Bias1)	---	3.766E-1	1.222E+0	-4.167E-2	-6.660E-1	1.340E-1	1.199E-1	-7.255E-1	-8.011E-1	-1.258E+0	4.275E-1
σ (Bias1)	---	2.769E-1	3.183E-1	2.211E-1	6.817E-1	9.958E-1	7.313E-1	4.111E-1	4.931E-1	4.177E-1	3.336E-1
Average+3σ (Bias1)	---	1.207E+0	2.176E+0	6.217E-1	1.379E+0	3.121E+0	2.314E+0	5.077E-1	6.783E-1	-5.138E-3	1.428E+0
Average-3σ (Bias1)	---	-4.541E-1	2.668E-1	-7.051E-1	-2.711E+0	-2.853E+0	-2.074E+0	-1.959E+0	-2.280E+0	-2.511E+0	-5.733E-1
Average (Bias2)	---	-1.010E-1	9.552E-1	2.896E-2	-4.230E-1	3.217E-1	-5.401E-1	-1.263E+0	-1.315E+0	-1.738E+0	6.259E-1
σ (Bias2)	---	2.937E-1	1.961E-1	1.014E-1	3.029E-1	9.820E-1	9.858E-2	2.536E-1	1.483E-1	2.995E-1	1.042E-1
Average+3σ (Bias2)	---	7.801E-1	1.544E+0	3.333E-1	4.857E-1	3.268E+0	-2.444E-1	-5.017E-1	-8.697E-1	-8.400E-1	9.383E-1
Average-3σ (Bias2)	---	-9.821E-1	3.668E-1	-2.754E-1	-1.332E+0	-2.624E+0	-8.359E-1	-2.023E+0	-1.759E+0	-2.637E+0	3.134E-1
Average (OFF)	---	-1.248E-1	1.198E+0	-5.686E-2	-4.077E-1	-1.010E+0	-5.762E-1	-1.693E+0	-1.609E+0	-2.248E+0	4.930E-1
σ (OFF)	---	1.721E-1	3.316E-1	2.053E-1	7.359E-2	3.976E-1	3.125E-1	1.149E-1	2.295E-1	1.291E-1	9.432E-2
Average+3σ (OFF)	---	3.915E-1	2.193E+0	5.591E-1	-1.869E-1	1.829E-1	3.613E-1	-1.348E+0	-9.204E-1	-1.861E+0	7.759E-1
Average-3σ (OFF)	---	-6.412E-1	2.028E-1	-6.728E-1	-6.285E-1	-2.202E+0	-1.514E+0	-2.037E+0	-2.298E+0	-2.635E+0	2.100E-1

15.K3

Ta = 25°C; IF = 10 mA ; Vdet = -15 V

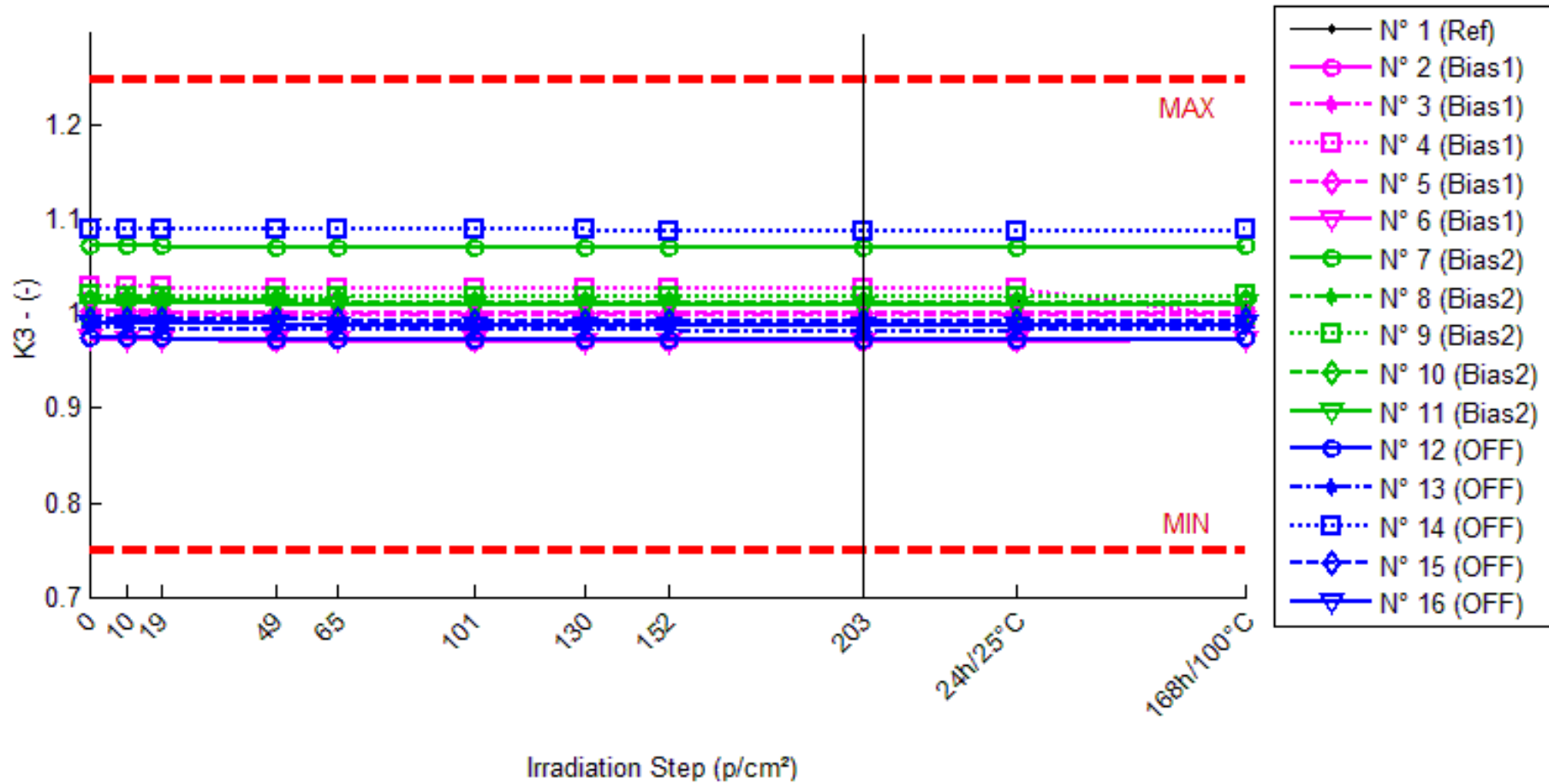

K3. (-) Min = 0.75 Max = 1.25

	0krad(Si)	10krad(Si)	19krad(Si)	49krad(Si)	65krad(Si)	101krad(Si)	130krad(Si)	152krad(Si)	203krad(Si)	24h/25°C	168h/100°C
N° 1 (Ref)	1.011	1.011	1.011	1.011	1.011	1.011	1.011	1.011	1.011	1.011	1.011
N° 2 (Bias1)	0.975	0.974	0.974	0.971	0.972	0.971	0.970	0.971	0.971	0.971	0.974
N° 3 (Bias1)	1.001	1.000	0.999	0.999	0.999	0.999	0.998	0.999	0.999	0.999	1.000
N° 4 (Bias1)	1.030	1.029	1.029	1.028	1.028	1.028	1.028	1.028	1.028	1.028	0.997
N° 5 (Bias1)	1.004	1.003	1.003	1.002	1.002	1.001	1.001	1.001	1.001	1.002	1.003
N° 6 (Bias1)	0.974	0.973	0.973	0.972	0.972	0.972	0.971	0.971	0.971	0.972	0.973
N° 7 (Bias1)	1.073	1.072	1.072	1.071	1.071	1.070	1.070	1.070	1.070	1.070	1.072
N° 8 (Bias2)	0.990	0.990	0.990	0.990	0.989	0.989	0.989	0.989	0.989	0.989	0.990
N° 9 (Bias2)	1.020	1.019	1.019	1.019	1.019	1.019	1.019	1.019	1.019	1.019	1.020
N° 10 (Bias2)	1.015	1.015	1.015	1.014	1.014	1.013	1.013	1.013	1.013	1.013	1.015
N° 11 (Bias2)	1.011	1.011	1.011	1.011	1.010	1.010	1.010	1.010	1.010	1.010	1.011
N° 12 (OFF)	0.974	0.974	0.974	0.973	0.973	0.973	0.973	0.973	0.973	0.973	0.974
N° 13 (OFF)	0.985	0.985	0.984	0.984	0.984	0.983	0.983	0.983	0.982	0.983	0.985
N° 14 (OFF)	1.090	1.090	1.090	1.090	1.090	1.090	1.089	1.089	1.089	1.089	1.090
N° 15 (OFF)	0.995	0.995	0.995	0.994	0.994	0.993	0.993	0.993	0.993	0.993	0.995
N° 16 (OFF)	0.990	0.990	0.990	0.990	0.989	0.989	0.989	0.989	0.989	0.989	0.990

Delta [K3]

	0krad(Si)	10krad(Si)	19krad(Si)	49krad(Si)	65krad(Si)	101krad(Si)	130krad(Si)	152krad(Si)	203krad(Si)	24h/25°C	168h/100°C
N° 1 (Ref)	---	-8.700E-5	-2.520E-4	1.170E-4	-4.800E-5	3.900E-5	-1.940E-4	-1.050E-4	-5.100E-5	5.700E-5	-1.200E-4
N° 2 (Bias1)	---	-4.775E-4	-1.103E-3	-3.366E-3	-3.093E-3	-3.588E-3	-4.356E-3	-4.089E-3	-3.986E-3	-3.555E-3	-3.885E-4
N° 3 (Bias1)	---	-9.361E-4	-1.253E-3	-1.485E-3	-1.685E-3	-1.915E-3	-2.160E-3	-1.996E-3	-1.909E-3	-1.655E-3	-4.810E-4
N° 4 (Bias1)	---	-7.900E-4	-5.490E-4	-1.375E-3	-1.474E-3	-1.885E-3	-1.910E-3	-1.980E-3	-2.020E-3	-1.961E-3	-3.273E-2
N° 5 (Bias1)	---	-9.740E-4	-8.800E-4	-1.606E-3	-1.735E-3	-2.073E-3	-2.189E-3	-2.070E-3	-2.106E-3	-1.982E-3	-2.810E-4
N° 6 (Bias1)	---	-8.223E-4	-4.832E-4	-1.558E-3	-1.618E-3	-1.917E-3	-2.225E-3	-2.109E-3	-2.096E-3	-1.861E-3	-5.587E-4
N° 7 (Bias2)	---	-9.020E-4	-1.019E-3	-1.486E-3	-1.631E-3	-2.189E-3	-2.464E-3	-2.328E-3	-2.246E-3	-2.105E-3	-9.460E-4
N° 8 (Bias2)	---	-5.975E-4	-3.535E-4	-6.579E-4	-8.115E-4	-1.230E-3	-1.250E-3	-1.214E-3	-1.190E-3	-1.073E-3	-3.250E-4
N° 9 (Bias2)	---	-4.880E-4	-3.990E-4	-3.210E-4	-3.770E-4	-5.950E-4	-9.580E-4	-8.070E-4	-8.270E-4	-7.640E-4	-1.480E-4
N° 10 (Bias2)	---	-9.280E-4	-2.060E-4	-1.234E-3	-1.737E-3	-2.282E-3	-2.081E-3	-2.347E-3	-2.336E-3	-2.485E-3	-3.600E-5
N° 11 (Bias2)	---	-4.590E-4	-4.020E-4	-7.850E-4	-9.710E-4	-1.250E-3	-1.301E-3	-1.240E-3	-1.221E-3	-1.152E-3	-3.680E-4
N° 12 (OFF)	---	-1.890E-4	-2.817E-4	-6.434E-4	-7.506E-4	-9.590E-4	-1.133E-3	-1.098E-3	-1.097E-3	-9.264E-4	-5.070E-5
N° 13 (OFF)	---	-5.709E-4	-7.658E-4	-1.117E-3	-1.335E-3	-2.155E-3	-2.601E-3	-2.643E-3	-2.821E-3	-2.671E-3	-2.482E-4
N° 14 (OFF)	---	-1.710E-4	7.800E-5	7.000E-5	-9.300E-5	-4.290E-4	-3.640E-4	-5.180E-4	-6.310E-4	-7.490E-4	3.830E-4
N° 15 (OFF)	---	-2.856E-4	-5.752E-4	-7.845E-4	-1.018E-3	-1.918E-3	-2.151E-3	-2.200E-3	-2.213E-3	-2.063E-3	1.877E-4
N° 16 (OFF)	---	-1.347E-4	-1.516E-4	-2.867E-4	-3.913E-4	-7.171E-4	-9.366E-4	-8.677E-4	-9.199E-4	-7.854E-4	2.439E-4
Average (Bias1)	---	-8.000E-4	-8.538E-4	-1.878E-3	-1.921E-3	-2.276E-3	-2.568E-3	-2.449E-3	-2.424E-3	-2.203E-3	-6.888E-3
σ (Bias1)	---	1.958E-4	3.365E-4	8.363E-4	6.627E-4	7.374E-4	1.007E-3	9.185E-4	8.772E-4	7.669E-4	1.445E-2
Average+3σ (Bias1)	---	-2.125E-4	1.556E-4	6.308E-4	6.691E-5	-6.355E-5	4.538E-4	3.065E-4	2.080E-4	9.761E-5	3.645E-2
Average-3σ (Bias1)	---	-1.387E-3	-1.863E-3	-4.387E-3	-3.909E-3	-4.488E-3	-5.590E-3	-5.204E-3	-5.055E-3	-4.504E-3	-5.023E-2
Average (Bias2)	---	-6.749E-4	-4.759E-4	-8.968E-4	-1.105E-3	-1.509E-3	-1.611E-3	-1.587E-3	-1.564E-3	-1.516E-3	-3.646E-4
σ (Bias2)	---	2.254E-4	3.139E-4	4.642E-4	5.723E-4	7.142E-4	6.328E-4	7.062E-4	6.822E-4	7.383E-4	3.516E-4
Average+3σ (Bias2)	---	1.214E-6	4.658E-4	4.959E-4	6.114E-4	6.334E-4	2.877E-4	5.313E-4	4.827E-4	6.992E-4	6.902E-4
Average-3σ (Bias2)	---	-1.351E-3	-1.418E-3	-2.289E-3	-2.822E-3	-3.652E-3	-3.509E-3	-3.706E-3	-3.611E-3	-3.731E-3	-1.419E-3
Average (OFF)	---	-2.702E-4	-3.393E-4	-5.522E-4	-7.176E-4	-1.236E-3	-1.437E-3	-1.466E-3	-1.536E-3	-1.439E-3	1.031E-4
σ (OFF)	---	1.771E-4	3.355E-4	4.578E-4	4.921E-4	7.595E-4	9.164E-4	9.106E-4	9.355E-4	8.766E-4	2.512E-4
Average+3σ (OFF)	---	2.610E-4	6.672E-4	8.212E-4	7.588E-4	1.043E-3	1.312E-3	1.266E-3	1.270E-3	1.191E-3	8.567E-4
Average-3σ (OFF)	---	-8.015E-4	-1.346E-3	-1.926E-3	-2.194E-3	-3.514E-3	-4.187E-3	-4.197E-3	-4.343E-3	-4.069E-3	-6.504E-4

16.BWFwd

Ta = 25°C; IF = 10 mA +/- 4 mA; RL = 50 Ohms

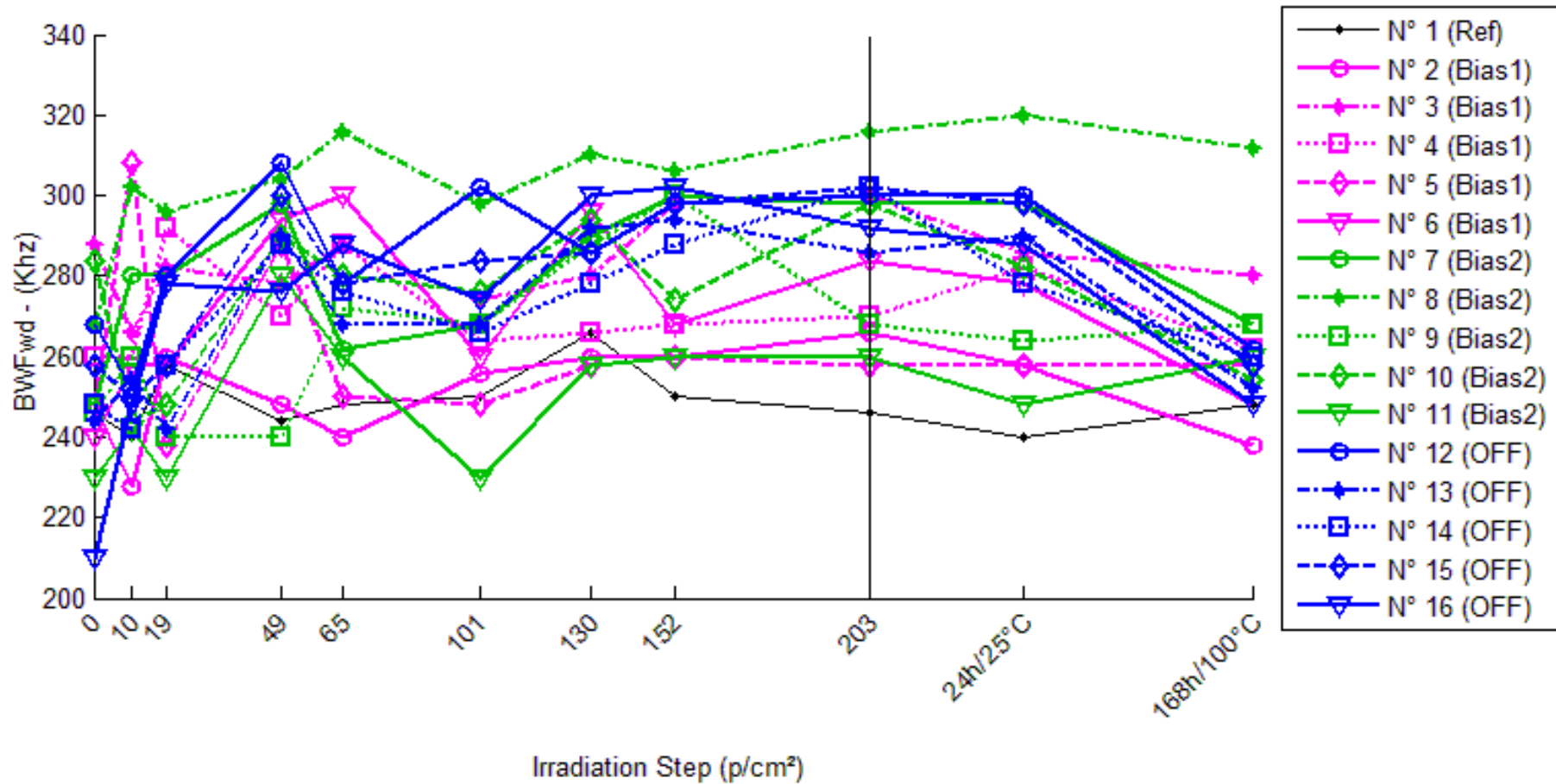

BWFwd . (Khz)

	0krad(Si)	10krad(Si)	19krad(Si)	49krad(Si)	65krad(Si)	101krad(Si)	130krad(Si)	152krad(Si)	203krad(Si)	24h/25°C	168h/100°C
N° 1 (Ref)	246.0	240.0	258.0	244.0	248.0	250.0	266.0	250.0	246.0	240.0	248.0
N° 2 (Bias1)	248.0	228.0	260.0	248.0	240.0	256.0	260.0	260.0	266.0	258.0	238.0
N° 3 (Bias1)	288.0	266.0	282.0	278.0	288.0	274.0	280.0	298.0	300.0	286.0	280.0
N° 4 (Bias1)	260.0	260.0	292.0	270.0	288.0	264.0	266.0	268.0	270.0	282.0	262.0
N° 5 (Bias1)	248.0	308.0	238.0	288.0	250.0	248.0	258.0	260.0	258.0	258.0	258.0
N° 6 (Bias1)	240.0	258.0	258.0	294.0	300.0	260.0	296.0	268.0	284.0	278.0	248.0
N° 7 (Bias2)	248.0	280.0	280.0	298.0	262.0	268.0	290.0	300.0	298.0	298.0	268.0
N° 8 (Bias2)	268.0	302.0	296.0	304.0	316.0	298.0	310.0	306.0	316.0	320.0	312.0
N° 9 (Bias2)	246.0	260.0	240.0	240.0	272.0	268.0	288.0	300.0	268.0	264.0	268.0
N° 10 (Bias2)	284.0	244.0	248.0	290.0	280.0	276.0	294.0	274.0	298.0	282.0	254.0
N° 11 (Bias2)	230.0	242.0	230.0	280.0	260.0	230.0	258.0	260.0	260.0	248.0	260.0
N° 12 (OFF)	268.0	252.0	280.0	308.0	278.0	302.0	286.0	298.0	300.0	300.0	262.0
N° 13 (OFF)	244.0	254.0	242.0	290.0	268.0	268.0	292.0	294.0	286.0	290.0	252.0
N° 14 (OFF)	248.0	242.0	258.0	288.0	276.0	266.0	278.0	288.0	302.0	278.0	260.0
N° 15 (OFF)	258.0	250.0	258.0	300.0	278.0	284.0	286.0	298.0	302.0	298.0	258.0
N° 16 (OFF)	210.0	248.0	278.0	276.0	288.0	274.0	300.0	302.0	292.0	288.0	248.0

Delta [BWFwd]

	0krad(Si)	10krad(Si)	19krad(Si)	49krad(Si)	65krad(Si)	101krad(Si)	130krad(Si)	152krad(Si)	203krad(Si)	24h/25°C	168h/100°C
N° 1 (Ref)	---	-6.000E+0	1.200E+1	-2.000E+0	2.000E+0	4.000E+0	2.000E+1	4.000E+0	0.000E+0	-6.000E+0	2.000E+0
N° 2 (Bias1)	---	-2.000E+1	1.200E+1	0.000E+0	-8.000E+0	8.000E+0	1.200E+1	1.200E+1	1.800E+1	1.000E+1	-1.000E+1
N° 3 (Bias1)	---	-2.200E+1	-6.000E+0	-1.000E+1	0.000E+0	-1.400E+1	-8.000E+0	1.000E+1	1.200E+1	-2.000E+0	-8.000E+0
N° 4 (Bias1)	---	0.000E+0	3.200E+1	1.000E+1	2.800E+1	4.000E+0	6.000E+0	8.000E+0	1.000E+1	2.200E+1	2.000E+0
N° 5 (Bias1)	---	6.000E+1	-1.000E+1	4.000E+1	2.000E+0	0.000E+0	1.000E+1	1.200E+1	1.000E+1	1.000E+1	1.000E+1
N° 6 (Bias1)	---	1.800E+1	1.800E+1	5.400E+1	6.000E+1	2.000E+1	5.600E+1	2.800E+1	4.400E+1	3.800E+1	8.000E+0
N° 7 (Bias2)	---	3.200E+1	3.200E+1	5.000E+1	1.400E+1	2.000E+1	4.200E+1	5.200E+1	5.000E+1	5.000E+1	2.000E+1
N° 8 (Bias2)	---	3.400E+1	2.800E+1	3.600E+1	4.800E+1	3.000E+1	4.200E+1	3.800E+1	4.800E+1	5.200E+1	4.400E+1
N° 9 (Bias2)	---	1.400E+1	-6.000E+0	-6.000E+0	2.600E+1	2.200E+1	4.200E+1	5.400E+1	2.200E+1	1.800E+1	2.200E+1
N° 10 (Bias2)	---	-4.000E+1	-3.600E+1	6.000E+0	-4.000E+0	-8.000E+0	1.000E+1	-1.000E+1	1.400E+1	-2.000E+0	-3.000E+1
N° 11 (Bias2)	---	1.200E+1	0.000E+0	5.000E+1	3.000E+1	0.000E+0	2.800E+1	3.000E+1	3.000E+1	1.800E+1	3.000E+1
N° 12 (OFF)	---	-1.600E+1	1.200E+1	4.000E+1	1.000E+1	3.400E+1	1.800E+1	3.000E+1	3.200E+1	3.200E+1	-6.000E+0
N° 13 (OFF)	---	1.000E+1	-2.000E+0	4.600E+1	2.400E+1	2.400E+1	4.800E+1	5.000E+1	4.200E+1	4.600E+1	8.000E+0
N° 14 (OFF)	---	-6.000E+0	1.000E+1	4.000E+1	2.800E+1	1.800E+1	3.000E+1	4.000E+1	5.400E+1	3.000E+1	1.200E+1
N° 15 (OFF)	---	-8.000E+0	0.000E+0	4.200E+1	2.000E+1	2.600E+1	2.800E+1	4.000E+1	4.400E+1	4.000E+1	0.000E+0
N° 16 (OFF)	---	3.800E+1	6.800E+1	6.600E+1	7.800E+1	6.400E+1	9.000E+1	9.200E+1	8.200E+1	7.800E+1	3.800E+1
Average (Bias1)	---	7.200E+0	9.200E+0	1.880E+1	1.640E+1	3.600E+0	1.520E+1	1.400E+1	1.880E+1	1.560E+1	4.000E-1
σ (Bias1)	---	3.372E+1	1.736E+1	2.715E+1	2.787E+1	1.236E+1	2.411E+1	8.000E+0	1.446E+1	1.513E+1	9.099E+0
Average+3σ (Bias1)	---	1.084E+2	6.127E+1	1.003E+2	1.000E+2	4.068E+1	8.752E+1	3.800E+1	6.219E+1	6.098E+1	2.770E+1
Average-3σ (Bias1)	---	-9.397E+1	-4.287E+1	-6.265E+1	-6.721E+1	-3.348E+1	-5.712E+1	-1.000E+1	-2.459E+1	-2.978E+1	-2.690E+1
Average (Bias2)	---	1.040E+1	3.600E+0	2.720E+1	2.280E+1	1.280E+1	3.280E+1	3.280E+1	3.280E+1	2.720E+1	1.720E+1
σ (Bias2)	---	2.991E+1	2.773E+1	2.583E+1	1.932E+1	1.604E+1	1.411E+1	2.591E+1	1.585E+1	2.322E+1	2.802E+1
Average+3σ (Bias2)	---	1.001E+2	8.678E+1	1.047E+2	8.076E+1	6.091E+1	7.514E+1	1.105E+2	8.035E+1	9.686E+1	1.013E+2
Average-3σ (Bias2)	---	-7.934E+1	-7.958E+1	-5.029E+1	-3.516E+1	-3.531E+1	-9.541E+0	-4.492E+1	-1.475E+1	-4.246E+1	-6.686E+1
Average (OFF)	---	3.600E+0	1.760E+1	4.680E+1	3.200E+1	3.320E+1	4.280E+1	5.040E+1	5.080E+1	4.520E+1	1.040E+1
σ (OFF)	---	2.142E+1	2.882E+1	1.101E+1	2.657E+1	1.814E+1	2.852E+1	2.431E+1	1.911E+1	1.942E+1	1.694E+1
Average+3σ (OFF)	---	6.786E+1	1.041E+2	7.983E+1	1.117E+2	8.763E+1	1.283E+2	1.233E+2	1.081E+2	1.035E+2	6.121E+1
Average-3σ (OFF)	---	-6.066E+1	-6.887E+1	1.377E+1	-4.771E+1	-2.123E+1	-4.275E+1	-2.252E+1	-6.531E+0	-1.306E+1	-4.041E+1

17. BWBack

Ta = 25°C; IF = 10 mA +/- 4 mA; RL = 50 Ohms

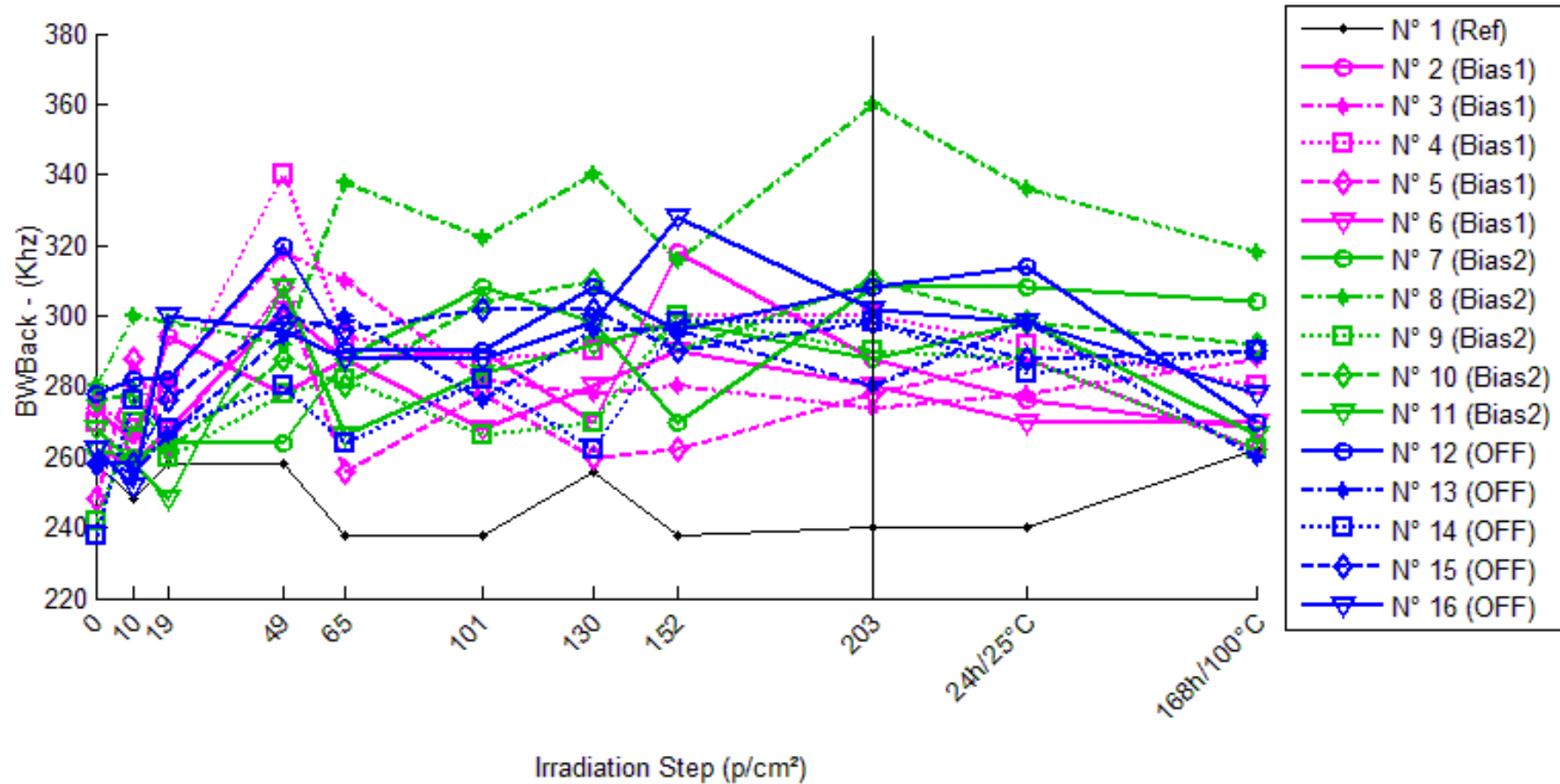

BWBack . (Khz)

	0krad(Si)	10krad(Si)	19krad(Si)	49krad(Si)	65krad(Si)	101krad(Si)	130krad(Si)	152krad(Si)	203krad(Si)	24h/25°C	168h/100°C
N° 1 (Ref)	258.0	248.0	258.0	258.0	238.0	238.0	256.0	238.0	240.0	240.0	262.0
N° 2 (Bias1)	274.0	264.0	294.0	278.0	288.0	290.0	270.0	318.0	288.0	276.0	268.0
N° 3 (Bias1)	276.0	266.0	282.0	318.0	310.0	282.0	278.0	280.0	274.0	278.0	288.0
N° 4 (Bias1)	270.0	268.0	278.0	340.0	294.0	288.0	290.0	300.0	300.0	292.0	280.0
N° 5 (Bias1)	248.0	288.0	264.0	308.0	256.0	278.0	260.0	262.0	278.0	288.0	262.0
N° 6 (Bias1)	262.0	258.0	268.0	302.0	288.0	268.0	280.0	290.0	280.0	270.0	270.0
N° 7 (Bias2)	262.0	260.0	264.0	264.0	288.0	308.0	298.0	270.0	308.0	308.0	304.0
N° 8 (Bias2)	280.0	300.0	298.0	292.0	338.0	322.0	340.0	316.0	360.0	336.0	318.0
N° 9 (Bias2)	242.0	270.0	260.0	278.0	282.0	266.0	270.0	300.0	290.0	288.0	262.0
N° 10 (Bias2)	276.0	278.0	262.0	288.0	280.0	304.0	310.0	290.0	310.0	298.0	292.0
N° 11 (Bias2)	268.0	258.0	248.0	308.0	266.0	284.0	298.0	288.0	266.0	298.0	266.0
N° 12 (OFF)	278.0	282.0	282.0	320.0	290.0	290.0	308.0	296.0	308.0	314.0	270.0
N° 13 (OFF)	258.0	256.0	266.0	294.0	300.0	276.0	296.0	296.0	280.0	298.0	260.0
N° 14 (OFF)	238.0	276.0	268.0	280.0	264.0	282.0	262.0	298.0	298.0	284.0	290.0
N° 15 (OFF)	258.0	258.0	276.0	300.0	296.0	302.0	302.0	290.0	298.0	288.0	290.0
N° 16 (OFF)	262.0	252.0	300.0	296.0	288.0	288.0	298.0	328.0	302.0	298.0	278.0

Delta [BWBack]

	0krad(Si)	10krad(Si)	19krad(Si)	49krad(Si)	65krad(Si)	101krad(Si)	130krad(Si)	152krad(Si)	203krad(Si)	24h/25°C	168h/100°C
N° 1 (Ref)	---	-1.000E+1	0.000E+0	0.000E+0	-2.000E+1	-2.000E+1	-2.000E+0	-2.000E+1	-1.800E+1	-1.800E+1	4.000E+0
N° 2 (Bias1)	---	-1.000E+1	2.000E+1	4.000E+0	1.400E+1	1.600E+1	-4.000E+0	4.400E+1	1.400E+1	2.000E+0	-6.000E+0
N° 3 (Bias1)	---	-1.000E+1	6.000E+0	4.200E+1	3.400E+1	6.000E+0	2.000E+0	4.000E+0	-2.000E+0	2.000E+0	1.200E+1
N° 4 (Bias1)	---	-2.000E+0	8.000E+0	7.000E+1	2.400E+1	1.800E+1	2.000E+1	3.000E+1	3.000E+1	2.200E+1	1.000E+1
N° 5 (Bias1)	---	4.000E+1	1.600E+1	6.000E+1	8.000E+0	3.000E+1	1.200E+1	1.400E+1	3.000E+1	4.000E+1	1.400E+1
N° 6 (Bias1)	---	-4.000E+0	6.000E+0	4.000E+1	2.600E+1	6.000E+0	1.800E+1	2.800E+1	1.800E+1	8.000E+0	8.000E+0
N° 7 (Bias2)	---	-2.000E+0	2.000E+0	2.000E+0	2.600E+1	4.600E+1	3.600E+1	8.000E+0	4.600E+1	4.600E+1	4.200E+1
N° 8 (Bias2)	---	2.000E+1	1.800E+1	1.200E+1	5.800E+1	4.200E+1	6.000E+1	3.600E+1	8.000E+1	5.600E+1	3.800E+1
N° 9 (Bias2)	---	2.800E+1	1.800E+1	3.600E+1	4.000E+1	2.400E+1	2.800E+1	5.800E+1	4.800E+1	4.600E+1	2.000E+1
N° 10 (Bias2)	---	2.000E+0	-1.400E+1	1.200E+1	4.000E+0	2.800E+1	3.400E+1	1.400E+1	3.400E+1	2.200E+1	1.600E+1
N° 11 (Bias2)	---	-1.000E+1	-2.000E+1	4.000E+1	-2.000E+0	1.600E+1	2.400E+1	3.000E+1	2.000E+1	3.000E+1	-2.000E+0
N° 12 (OFF)	---	4.000E+0	4.000E+0	4.200E+1	1.200E+1	1.200E+1	3.000E+1	1.800E+1	3.000E+1	3.600E+1	-8.000E+0
N° 13 (OFF)	---	-2.000E+0	8.000E+0	3.600E+1	4.200E+1	1.800E+1	3.800E+1	3.800E+1	2.200E+1	4.000E+1	2.000E+0
N° 14 (OFF)	---	3.800E+1	3.000E+1	4.200E+1	2.600E+1	4.400E+1	2.400E+1	6.000E+1	6.000E+1	4.600E+1	5.200E+1
N° 15 (OFF)	---	0.000E+0	1.800E+1	4.200E+1	3.800E+1	4.400E+1	4.400E+1	3.200E+1	4.000E+1	3.000E+1	3.200E+1
N° 16 (OFF)	---	-1.000E+1	3.800E+1	3.400E+1	2.600E+1	2.600E+1	3.600E+1	6.600E+1	4.000E+1	3.600E+1	1.600E+1
Average (Bias1)	---	2.800E+0	1.120E+1	4.320E+1	2.120E+1	1.520E+1	9.600E+0	2.400E+1	1.800E+1	1.480E+1	7.600E+0
σ (Bias1)	---	2.110E+1	6.419E+0	2.524E+1	1.026E+1	9.960E+0	1.033E+1	1.543E+1	1.327E+1	1.628E+1	7.925E+0
Average+3σ (Bias1)	---	6.610E+1	3.046E+1	1.189E+2	5.197E+1	4.508E+1	4.060E+1	7.028E+1	5.780E+1	6.365E+1	3.137E+1
Average-3σ (Bias1)	---	-6.050E+1	-8.056E+0	-3.253E+1	-9.570E+0	-1.468E+1	-2.140E+1	-2.228E+1	-2.180E+1	-3.405E+1	-1.617E+1
Average (Bias2)	---	7.600E+0	8.000E-1	2.040E+1	2.520E+1	3.120E+1	3.640E+1	2.920E+1	4.560E+1	4.000E+1	2.280E+1
σ (Bias2)	---	1.584E+1	1.764E+1	1.664E+1	2.492E+1	1.254E+1	1.403E+1	1.973E+1	2.224E+1	1.371E+1	1.781E+1
Average+3σ (Bias2)	---	5.511E+1	5.372E+1	7.031E+1	9.997E+1	6.881E+1	7.849E+1	8.838E+1	1.123E+2	8.113E+1	7.623E+1
Average-3σ (Bias2)	---	-3.991E+1	-5.212E+1	-2.951E+1	-4.957E+1	-6.414E+0	-5.686E+0	-2.998E+1	-2.113E+1	-1.134E+0	-3.063E+1
Average (OFF)	---	6.000E+0	1.960E+1	3.920E+1	2.880E+1	2.880E+1	3.440E+1	4.280E+1	3.840E+1	3.760E+1	1.880E+1
σ (OFF)	---	1.860E+1	1.438E+1	3.899E+0	1.180E+1	1.474E+1	7.668E+0	1.993E+1	1.424E+1	5.899E+0	2.390E+1
Average+3σ (OFF)	---	6.180E+1	6.274E+1	5.090E+1	6.419E+1	7.301E+1	5.740E+1	1.026E+2	8.112E+1	5.530E+1	9.050E+1
Average-3σ (OFF)	---	-4.980E+1	-2.354E+1	2.750E+1	-6.595E+0	-1.541E+1	1.140E+1	-1.699E+1	-4.322E+0	1.990E+1	-5.290E+1

18. TRFwd

Ta = 25°C; IF = 10 mA +/- 4 mA; RL = 50 Ohms

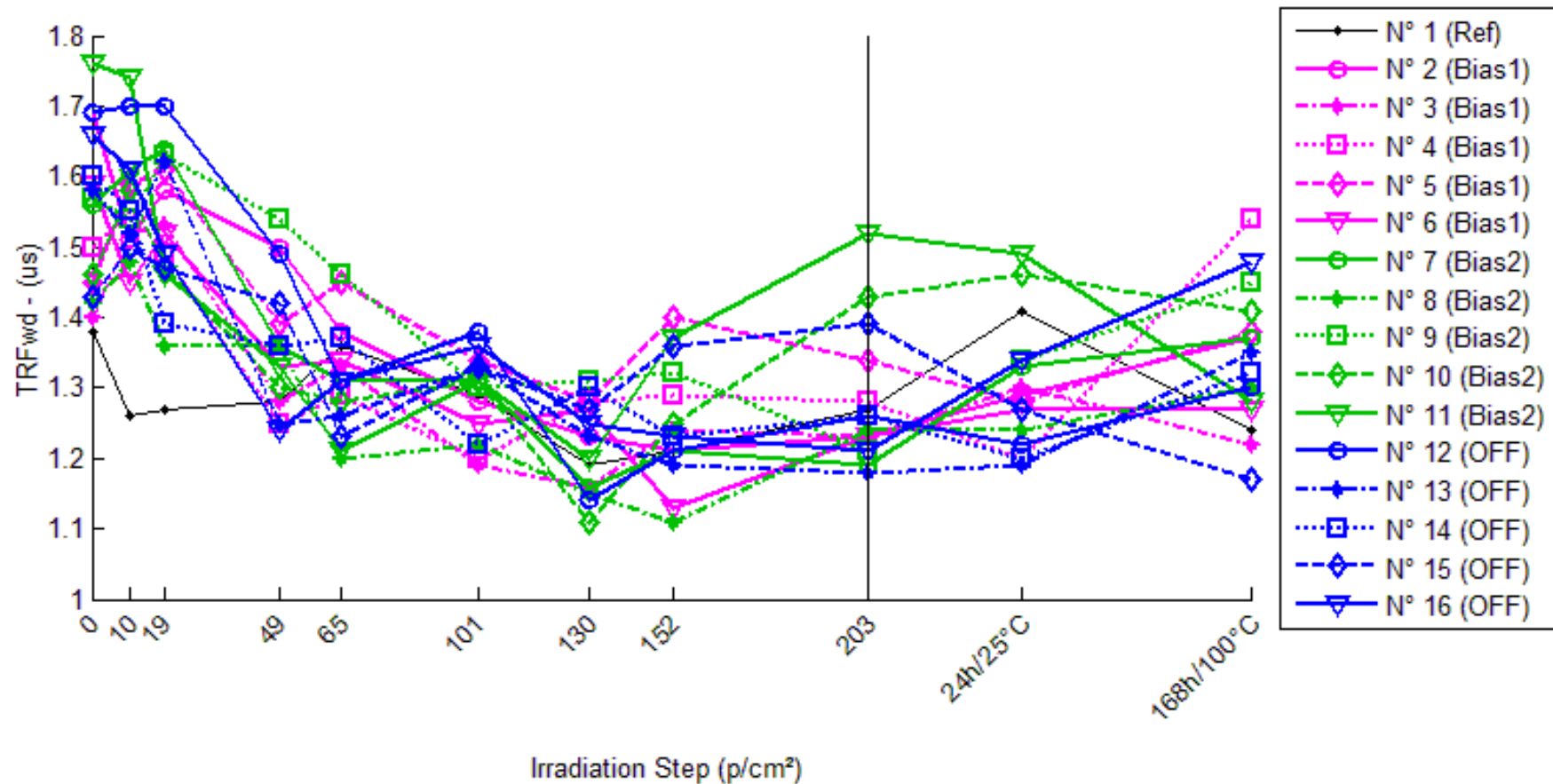

TRFwd . (us)

	0krad(Si)	10krad(Si)	19krad(Si)	49krad(Si)	65krad(Si)	101krad(Si)	130krad(Si)	152krad(Si)	203krad(Si)	24h/25°C	168h/100°C
N° 1 (Ref)	1.38	1.26	1.27	1.28	1.36	1.29	1.19	1.21	1.27	1.41	1.24
N° 2 (Bias1)	1.69	1.51	1.58	1.50	1.38	1.28	1.23	1.21	1.23	1.29	1.37
N° 3 (Bias1)	1.40	1.52	1.53	1.28	1.33	1.19	1.16	1.24	1.23	1.30	1.22
N° 4 (Bias1)	1.50	1.55	1.49	1.25	1.29	1.20	1.28	1.29	1.28	1.20	1.54
N° 5 (Bias1)	1.45	1.59	1.61	1.39	1.45	1.34	1.28	1.40	1.34	1.28	1.38
N° 6 (Bias1)	1.59	1.45	1.52	1.33	1.34	1.25	1.27	1.13	1.23	1.27	1.27
N° 7 (Bias2)	1.56	1.61	1.64	1.36	1.31	1.31	1.16	1.21	1.19	1.33	1.37
N° 8 (Bias2)	1.42	1.48	1.36	1.36	1.20	1.22	1.15	1.11	1.24	1.24	1.30
N° 9 (Bias2)	1.57	1.54	1.63	1.54	1.46	1.30	1.31	1.32	1.21	1.34	1.45
N° 10 (Bias2)	1.46	1.58	1.47	1.30	1.28	1.31	1.11	1.25	1.43	1.46	1.41
N° 11 (Bias2)	1.76	1.74	1.46	1.33	1.21	1.31	1.20	1.37	1.52	1.49	1.28
N° 12 (OFF)	1.69	1.70	1.70	1.49	1.31	1.38	1.14	1.21	1.26	1.22	1.30
N° 13 (OFF)	1.58	1.52	1.62	1.25	1.26	1.33	1.23	1.19	1.18	1.19	1.35
N° 14 (OFF)	1.60	1.55	1.39	1.36	1.37	1.22	1.30	1.23	1.26	1.20	1.32
N° 15 (OFF)	1.43	1.50	1.47	1.42	1.23	1.33	1.27	1.36	1.39	1.27	1.17
N° 16 (OFF)	1.66	1.61	1.49	1.24	1.31	1.36	1.25	1.23	1.21	1.34	1.48

Delta [TRFwd]

	0krad(Si)	10krad(Si)	19krad(Si)	49krad(Si)	65krad(Si)	101krad(Si)	130krad(Si)	152krad(Si)	203krad(Si)	24h/25°C	168h/100°C
N° 1 (Ref)	---	-1.200E-1	-1.100E-1	-1.000E-1	-2.000E-2	-9.000E-2	-1.900E-1	-1.700E-1	-1.100E-1	3.000E-2	-1.400E-1
N° 2 (Bias1)	---	-1.800E-1	-1.100E-1	-1.900E-1	-3.100E-1	-4.100E-1	-4.600E-1	-4.800E-1	-4.600E-1	-4.000E-1	-3.200E-1
N° 3 (Bias1)	---	1.200E-1	1.300E-1	-1.200E-1	-7.000E-2	-2.100E-1	-2.400E-1	-1.600E-1	-1.700E-1	-1.000E-1	-1.800E-1
N° 4 (Bias1)	---	5.000E-2	-1.000E-2	-2.500E-1	-2.100E-1	-3.000E-1	-2.200E-1	-2.100E-1	-2.200E-1	-3.000E-1	4.000E-2
N° 5 (Bias1)	---	1.400E-1	1.600E-1	-6.000E-2	0.000E+0	-1.100E-1	-1.700E-1	-5.000E-2	-1.100E-1	-1.700E-1	-7.000E-2
N° 6 (Bias1)	---	-1.400E-1	-7.000E-2	-2.600E-1	-2.500E-1	-3.400E-1	-3.200E-1	-4.600E-1	-3.600E-1	-3.200E-1	-3.200E-1
N° 7 (Bias2)	---	5.000E-2	8.000E-2	-2.000E-1	-2.500E-1	-2.500E-1	-4.000E-1	-3.500E-1	-3.700E-1	-2.300E-1	-1.900E-1
N° 8 (Bias2)	---	6.000E-2	-6.000E-2	-6.000E-2	-2.200E-1	-2.000E-1	-2.700E-1	-3.100E-1	-1.800E-1	-1.800E-1	-1.200E-1
N° 9 (Bias2)	---	-3.000E-2	6.000E-2	-3.000E-2	-1.100E-1	-2.700E-1	-2.600E-1	-2.500E-1	-3.600E-1	-2.300E-1	-1.200E-1
N° 10 (Bias2)	---	1.200E-1	1.000E-2	-1.600E-1	-1.800E-1	-1.500E-1	-3.500E-1	-2.100E-1	-3.000E-2	0.000E+0	-5.000E-2
N° 11 (Bias2)	---	-2.000E-2	-3.000E-1	-4.300E-1	-5.500E-1	-4.500E-1	-5.600E-1	-3.900E-1	-2.400E-1	-2.700E-1	-4.800E-1
N° 12 (OFF)	---	1.000E-2	1.000E-2	-2.000E-1	-3.800E-1	-3.100E-1	-5.500E-1	-4.800E-1	-4.300E-1	-4.700E-1	-3.900E-1
N° 13 (OFF)	---	-6.000E-2	4.000E-2	-3.300E-1	-3.200E-1	-2.500E-1	-3.500E-1	-3.900E-1	-4.000E-1	-3.900E-1	-2.300E-1
N° 14 (OFF)	---	-5.000E-2	-2.100E-1	-2.400E-1	-2.300E-1	-3.800E-1	-3.000E-1	-3.700E-1	-3.400E-1	-4.000E-1	-2.800E-1
N° 15 (OFF)	---	7.000E-2	4.000E-2	-1.000E-2	-2.000E-1	-1.000E-1	-1.600E-1	-7.000E-2	-4.000E-2	-1.600E-1	-2.600E-1
N° 16 (OFF)	---	-5.000E-2	-1.700E-1	-4.200E-1	-3.500E-1	-3.000E-1	-4.100E-1	-4.300E-1	-4.500E-1	-3.200E-1	-1.800E-1
Average (Bias1)	---	-2.000E-3	2.000E-2	-1.760E-1	-1.680E-1	-2.740E-1	-2.820E-1	-2.720E-1	-2.640E-1	-2.580E-1	-1.700E-1
σ (Bias1)	---	1.487E-1	1.200E-1	8.562E-2	1.289E-1	1.167E-1	1.132E-1	1.899E-1	1.433E-1	1.209E-1	1.575E-1
Average+3σ (Bias1)	---	4.442E-1	3.800E-1	8.085E-2	2.188E-1	7.624E-2	5.768E-2	2.978E-1	1.658E-1	1.047E-1	3.024E-1
Average-3σ (Bias1)	---	-4.482E-1	-3.400E-1	-4.328E-1	-5.548E-1	-6.242E-1	-6.217E-1	-8.418E-1	-6.938E-1	-6.207E-1	-6.424E-1
Average (Bias2)	---	3.600E-2	-4.200E-2	-1.760E-1	-2.620E-1	-2.640E-1	-3.680E-1	-3.020E-1	-2.360E-1	-1.820E-1	-1.920E-1
σ (Bias2)	---	6.189E-2	1.540E-1	1.582E-1	1.693E-1	1.139E-1	1.219E-1	7.294E-2	1.405E-1	1.066E-1	1.684E-1
Average+3σ (Bias2)	---	2.217E-1	4.200E-1	2.986E-1	2.460E-1	7.779E-2	-2.172E-3	-8.319E-2	1.854E-1	1.379E-1	3.133E-1
Average-3σ (Bias2)	---	-1.497E-1	-5.040E-1	-6.506E-1	-7.700E-1	-6.058E-1	-7.338E-1	-5.208E-1	-6.574E-1	-5.019E-1	-6.973E-1
Average (OFF)	---	-1.600E-2	-5.800E-2	-2.400E-1	-2.960E-1	-2.680E-1	-3.540E-1	-3.480E-1	-3.320E-1	-3.480E-1	-2.680E-1
σ (OFF)	---	5.550E-2	1.219E-1	1.541E-1	7.765E-2	1.047E-1	1.433E-1	1.610E-1	1.684E-1	1.178E-1	7.791E-2
Average+3σ (OFF)	---	1.505E-1	3.078E-1	2.223E-1	-6.304E-2	4.621E-2	7.585E-2	1.350E-1	1.733E-1	5.313E-3	-3.427E-2
Average-3σ (OFF)	---	-1.825E-1	-4.238E-1	-7.023E-1	-5.290E-1	-5.822E-1	-7.838E-1	-8.310E-1	-8.373E-1	-7.013E-1	-5.017E-1

19. TFFwd

Ta = 25°C; IF = 10 mA +/- 4 mA; RL = 50 Ohms

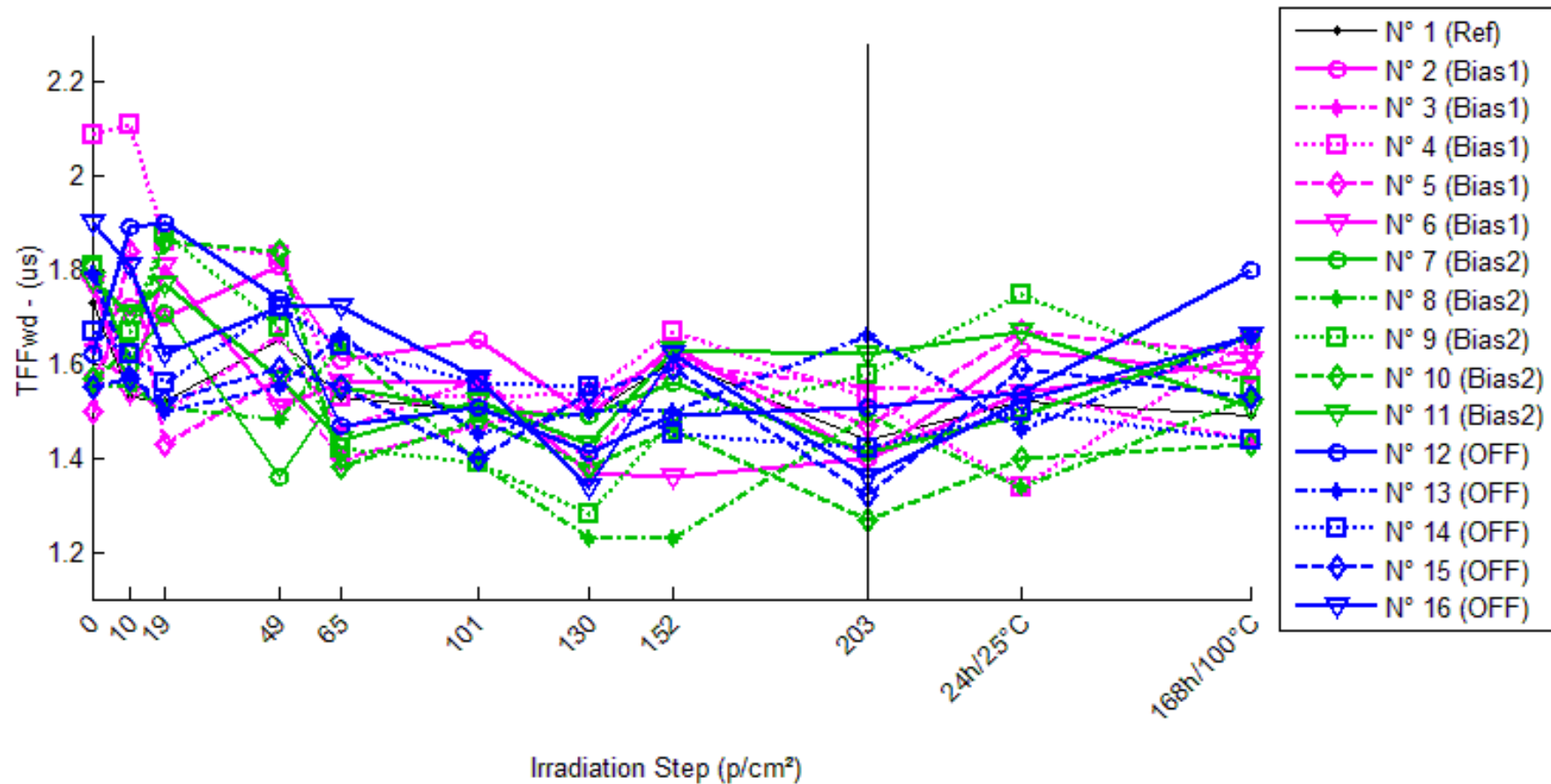

TFFwd . (us)

	0krad(Si)	10krad(Si)	19krad(Si)	49krad(Si)	65krad(Si)	101krad(Si)	130krad(Si)	152krad(Si)	203krad(Si)	24h/25°C	168h/100°C
N° 1 (Ref)	1.73	1.53	1.52	1.65	1.53	1.50	1.49	1.61	1.44	1.52	1.49
N° 2 (Bias1)	1.57	1.72	1.70	1.81	1.61	1.65	1.49	1.64	1.40	1.63	1.58
N° 3 (Bias1)	1.64	1.55	1.50	1.66	1.46	1.57	1.40	1.60	1.55	1.54	1.44
N° 4 (Bias1)	2.09	2.11	1.86	1.83	1.53	1.53	1.54	1.67	1.53	1.34	1.65
N° 5 (Bias1)	1.50	1.84	1.43	1.57	1.40	1.47	1.52	1.62	1.47	1.67	1.62
N° 6 (Bias1)	1.77	1.54	1.81	1.51	1.56	1.56	1.37	1.36	1.40	1.54	1.61
N° 7 (Bias2)	1.81	1.60	1.71	1.36	1.55	1.50	1.49	1.56	1.41	1.49	1.66
N° 8 (Bias2)	1.55	1.55	1.51	1.48	1.64	1.39	1.23	1.23	1.49	1.34	1.53
N° 9 (Bias2)	1.81	1.67	1.88	1.68	1.42	1.39	1.28	1.48	1.58	1.75	1.55
N° 10 (Bias2)	1.57	1.63	1.86	1.84	1.38	1.48	1.38	1.46	1.27	1.40	1.43
N° 11 (Bias2)	1.78	1.71	1.77	1.57	1.44	1.52	1.43	1.63	1.62	1.67	1.51
N° 12 (OFF)	1.62	1.89	1.90	1.74	1.47	1.51	1.41	1.49	1.51	1.54	1.80
N° 13 (OFF)	1.79	1.58	1.50	1.55	1.66	1.45	1.50	1.50	1.66	1.46	1.66
N° 14 (OFF)	1.67	1.62	1.56	1.72	1.64	1.56	1.55	1.45	1.42	1.50	1.44
N° 15 (OFF)	1.55	1.57	1.52	1.59	1.55	1.40	1.54	1.59	1.32	1.59	1.53
N° 16 (OFF)	1.90	1.81	1.62	1.72	1.72	1.57	1.34	1.62	1.36	1.52	1.66

Delta [TFFwd]

	0krad(Si)	10krad(Si)	19krad(Si)	49krad(Si)	65krad(Si)	101krad(Si)	130krad(Si)	152krad(Si)	203krad(Si)	24h/25°C	168h/100°C
N° 1 (Ref)	---	-2.000E-1	-2.100E-1	-8.000E-2	-2.000E-1	-2.300E-1	-2.400E-1	-1.200E-1	-2.900E-1	-2.100E-1	-2.400E-1
N° 2 (Bias1)	---	1.500E-1	1.300E-1	2.400E-1	4.000E-2	8.000E-2	-8.000E-2	7.000E-2	-1.700E-1	6.000E-2	1.000E-2
N° 3 (Bias1)	---	-9.000E-2	-1.400E-1	2.000E-2	-1.800E-1	-7.000E-2	-2.400E-1	-4.000E-2	-9.000E-2	-1.000E-1	-2.000E-1
N° 4 (Bias1)	---	2.000E-2	-2.300E-1	-2.600E-1	-5.600E-1	-5.600E-1	-5.500E-1	-4.200E-1	-5.600E-1	-7.500E-1	-4.400E-1
N° 5 (Bias1)	---	3.400E-1	-7.000E-2	7.000E-2	-1.000E-1	-3.000E-2	2.000E-2	1.200E-1	-3.000E-2	1.700E-1	1.200E-1
N° 6 (Bias1)	---	-2.300E-1	4.000E-2	-2.600E-1	-2.100E-1	-2.100E-1	-4.000E-1	-4.100E-1	-3.700E-1	-2.300E-1	-1.600E-1
N° 7 (Bias2)	---	-2.100E-1	-1.000E-1	-4.500E-1	-2.600E-1	-3.100E-1	-3.200E-1	-2.500E-1	-4.000E-1	-3.200E-1	-1.500E-1
N° 8 (Bias2)	---	0.000E+0	-4.000E-2	-7.000E-2	9.000E-2	-1.600E-1	-3.200E-1	-3.200E-1	-6.000E-2	-2.100E-1	-2.000E-2
N° 9 (Bias2)	---	-1.400E-1	7.000E-2	-1.300E-1	-3.900E-1	-4.200E-1	-5.300E-1	-3.300E-1	-2.300E-1	-6.000E-2	-2.600E-1
N° 10 (Bias2)	---	6.000E-2	2.900E-1	2.700E-1	-1.900E-1	-9.000E-2	-1.900E-1	-1.100E-1	-3.000E-1	-1.700E-1	-1.400E-1
N° 11 (Bias2)	---	-7.000E-2	-1.000E-2	-2.100E-1	-3.400E-1	-2.600E-1	-3.500E-1	-1.500E-1	-1.600E-1	-1.100E-1	-2.700E-1
N° 12 (OFF)	---	2.700E-1	2.800E-1	1.200E-1	-1.500E-1	-1.100E-1	-2.100E-1	-1.300E-1	-1.100E-1	-8.000E-2	1.800E-1
N° 13 (OFF)	---	-2.100E-1	-2.900E-1	-2.400E-1	-1.300E-1	-3.400E-1	-2.900E-1	-2.900E-1	-1.300E-1	-3.300E-1	-1.300E-1
N° 14 (OFF)	---	-5.000E-2	-1.100E-1	5.000E-2	-3.000E-2	-1.100E-1	-1.200E-1	-2.200E-1	-2.500E-1	-1.700E-1	-2.300E-1
N° 15 (OFF)	---	2.000E-2	-3.000E-2	4.000E-2	0.000E+0	-1.500E-1	-1.000E-2	4.000E-2	-2.300E-1	4.000E-2	-2.000E-2
N° 16 (OFF)	---	-9.000E-2	-2.800E-1	-1.800E-1	-1.800E-1	-3.300E-1	-5.600E-1	-2.800E-1	-5.400E-1	-3.800E-1	-2.400E-1
Average (Bias1)	---	3.800E-2	-5.400E-2	-3.800E-2	-2.020E-1	-1.580E-1	-2.500E-1	-1.360E-1	-2.440E-1	-1.700E-1	-1.340E-1
σ (Bias1)	---	2.192E-1	1.426E-1	2.184E-1	2.223E-1	2.475E-1	2.315E-1	2.612E-1	2.184E-1	3.583E-1	2.144E-1
Average+3σ (Bias1)	---	6.957E-1	3.737E-1	6.173E-1	4.649E-1	5.846E-1	4.446E-1	6.476E-1	4.111E-1	9.048E-1	5.093E-1
Average-3σ (Bias1)	---	-6.197E-1	-4.817E-1	-6.933E-1	-8.689E-1	-9.006E-1	-9.446E-1	-9.196E-1	-8.991E-1	-1.245E+0	-7.773E-1
Average (Bias2)	---	-7.200E-2	4.200E-2	-1.180E-1	-2.180E-1	-2.480E-1	-3.420E-1	-2.320E-1	-2.300E-1	-1.740E-1	-1.680E-1
σ (Bias2)	---	1.076E-1	1.516E-1	2.606E-1	1.883E-1	1.287E-1	1.219E-1	9.910E-2	1.300E-1	9.965E-2	1.023E-1
Average+3σ (Bias2)	---	2.507E-1	4.967E-1	6.638E-1	3.470E-1	1.382E-1	2.383E-2	6.529E-2	1.600E-1	1.249E-1	1.390E-1
Average-3σ (Bias2)	---	-3.947E-1	-4.127E-1	-8.998E-1	-7.830E-1	-6.342E-1	-7.078E-1	-5.293E-1	-6.200E-1	-4.729E-1	-4.750E-1
Average (OFF)	---	-1.200E-2	-8.600E-2	-4.200E-2	-9.800E-2	-2.080E-1	-2.380E-1	-1.760E-1	-2.520E-1	-1.840E-1	-8.800E-2
σ (OFF)	---	1.784E-1	2.329E-1	1.579E-1	7.855E-2	1.171E-1	2.080E-1	1.365E-1	1.721E-1	1.739E-1	1.743E-1
Average+3σ (OFF)	---	5.231E-1	6.126E-1	4.316E-1	1.376E-1	1.434E-1	3.860E-1	2.335E-1	2.643E-1	3.376E-1	4.348E-1
Average-3σ (OFF)	---	-5.471E-1	-7.846E-1	-5.156E-1	-3.336E-1	-5.594E-1	-8.620E-1	-5.855E-1	-7.683E-1	-7.056E-1	-6.108E-1

20. TRBack

Ta = 25°C; IF = 10 mA +/- 4mA; RL = 50 Ohms

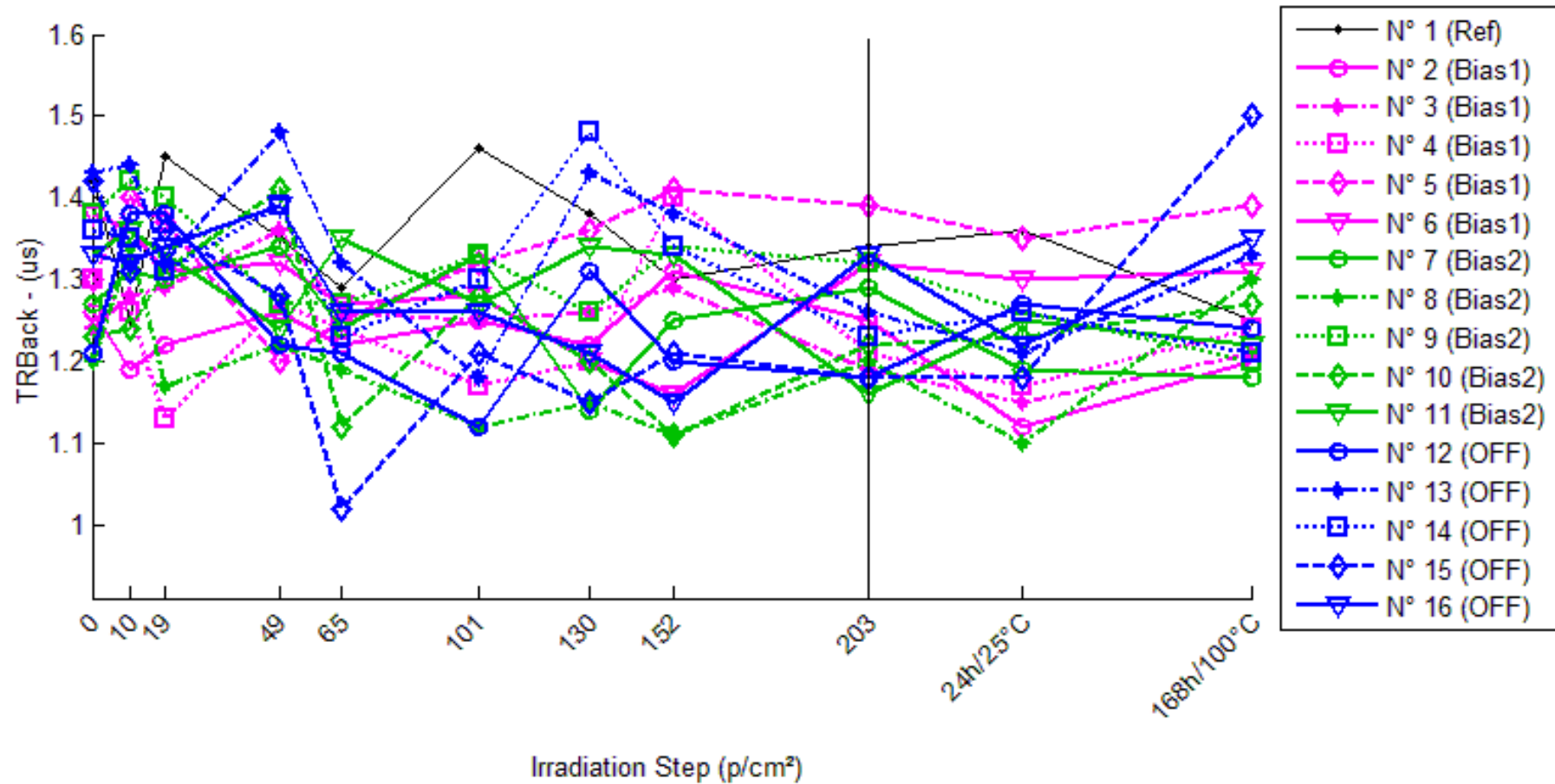

TRBack . (us)

	0krad(Si)	10krad(Si)	19krad(Si)	49krad(Si)	65krad(Si)	101krad(Si)	130krad(Si)	152krad(Si)	203krad(Si)	24h/25°C	168h/100°C
N° 1 (Ref)	1.42	1.25	1.45	1.35	1.29	1.46	1.38	1.30	1.34	1.36	1.25
N° 2 (Bias1)	1.26	1.19	1.22	1.26	1.22	1.25	1.22	1.31	1.25	1.12	1.20
N° 3 (Bias1)	1.24	1.28	1.29	1.36	1.26	1.25	1.26	1.29	1.19	1.15	1.21
N° 4 (Bias1)	1.30	1.26	1.13	1.27	1.24	1.17	1.20	1.40	1.21	1.17	1.24
N° 5 (Bias1)	1.30	1.40	1.37	1.20	1.25	1.32	1.36	1.41	1.39	1.35	1.39
N° 6 (Bias1)	1.38	1.36	1.31	1.32	1.27	1.28	1.20	1.16	1.32	1.30	1.31
N° 7 (Bias2)	1.27	1.31	1.30	1.34	1.24	1.33	1.14	1.25	1.29	1.19	1.18
N° 8 (Bias2)	1.20	1.34	1.17	1.22	1.19	1.12	1.15	1.11	1.20	1.10	1.30
N° 9 (Bias2)	1.38	1.42	1.40	1.27	1.27	1.33	1.26	1.34	1.32	1.26	1.20
N° 10 (Bias2)	1.23	1.24	1.31	1.41	1.12	1.28	1.20	1.11	1.22	1.23	1.27
N° 11 (Bias2)	1.33	1.36	1.33	1.24	1.35	1.27	1.34	1.33	1.16	1.25	1.22
N° 12 (OFF)	1.21	1.38	1.38	1.22	1.21	1.12	1.31	1.20	1.18	1.27	1.24
N° 13 (OFF)	1.43	1.44	1.32	1.48	1.32	1.18	1.43	1.38	1.26	1.21	1.33
N° 14 (OFF)	1.36	1.35	1.31	1.39	1.23	1.30	1.48	1.34	1.23	1.26	1.21
N° 15 (OFF)	1.42	1.31	1.36	1.28	1.02	1.21	1.15	1.21	1.18	1.18	1.50
N° 16 (OFF)	1.33	1.32	1.34	1.39	1.26	1.26	1.21	1.15	1.33	1.22	1.35

Delta [TRBack]

	0krad(Si)	10krad(Si)	19krad(Si)	49krad(Si)	65krad(Si)	101krad(Si)	130krad(Si)	152krad(Si)	203krad(Si)	24h/25°C	168h/100°C
N° 1 (Ref)	---	-1.700E-1	3.000E-2	-7.000E-2	-1.300E-1	4.000E-2	-4.000E-2	-1.200E-1	-8.000E-2	-6.000E-2	-1.700E-1
N° 2 (Bias1)	---	-7.000E-2	-4.000E-2	0.000E+0	-4.000E-2	-1.000E-2	-4.000E-2	5.000E-2	-1.000E-2	-1.400E-1	-6.000E-2
N° 3 (Bias1)	---	4.000E-2	5.000E-2	1.200E-1	2.000E-2	1.000E-2	2.000E-2	5.000E-2	-5.000E-2	-9.000E-2	-3.000E-2
N° 4 (Bias1)	---	-4.000E-2	-1.700E-1	-3.000E-2	-6.000E-2	-1.300E-1	-1.000E-1	1.000E-1	-9.000E-2	-1.300E-1	-6.000E-2
N° 5 (Bias1)	---	1.000E-1	7.000E-2	-1.000E-1	-5.000E-2	2.000E-2	6.000E-2	1.100E-1	9.000E-2	5.000E-2	9.000E-2
N° 6 (Bias1)	---	-2.000E-2	-7.000E-2	-6.000E-2	-1.100E-1	-1.000E-1	-1.800E-1	-2.200E-1	-6.000E-2	-8.000E-2	-7.000E-2
N° 7 (Bias2)	---	4.000E-2	3.000E-2	7.000E-2	-3.000E-2	6.000E-2	-1.300E-1	-2.000E-2	2.000E-2	-8.000E-2	-9.000E-2
N° 8 (Bias2)	---	1.400E-1	-3.000E-2	2.000E-2	-1.000E-2	-8.000E-2	-5.000E-2	-9.000E-2	0.000E+0	-1.000E-1	1.000E-1
N° 9 (Bias2)	---	4.000E-2	2.000E-2	-1.100E-1	-1.100E-1	-5.000E-2	-1.200E-1	-4.000E-2	-6.000E-2	-1.200E-1	-1.800E-1
N° 10 (Bias2)	---	1.000E-2	8.000E-2	1.800E-1	-1.100E-1	5.000E-2	-3.000E-2	-1.200E-1	-1.000E-2	0.000E+0	4.000E-2
N° 11 (Bias2)	---	3.000E-2	0.000E+0	-9.000E-2	2.000E-2	-6.000E-2	1.000E-2	0.000E+0	-1.700E-1	-8.000E-2	-1.100E-1
N° 12 (OFF)	---	1.700E-1	1.700E-1	1.000E-2	0.000E+0	-9.000E-2	1.000E-1	-1.000E-2	-3.000E-2	6.000E-2	3.000E-2
N° 13 (OFF)	---	1.000E-2	-1.100E-1	5.000E-2	-1.100E-1	-2.500E-1	0.000E+0	-5.000E-2	-1.700E-1	-2.200E-1	-1.000E-1
N° 14 (OFF)	---	-1.000E-2	-5.000E-2	3.000E-2	-1.300E-1	-6.000E-2	1.200E-1	-2.000E-2	-1.300E-1	-1.000E-1	-1.500E-1
N° 15 (OFF)	---	-1.100E-1	-6.000E-2	-1.400E-1	-4.000E-1	-2.100E-1	-2.700E-1	-2.100E-1	-2.400E-1	-2.400E-1	8.000E-2
N° 16 (OFF)	---	-1.000E-2	1.000E-2	6.000E-2	-7.000E-2	-7.000E-2	-1.200E-1	-1.800E-1	0.000E+0	-1.100E-1	2.000E-2
Average (Bias1)	---	2.000E-3	-3.200E-2	-1.400E-2	-4.800E-2	-4.200E-2	-4.800E-2	1.800E-2	-2.400E-2	-7.800E-2	-2.600E-2
σ (Bias1)	---	6.797E-2	9.706E-2	8.355E-2	4.658E-2	6.834E-2	9.550E-2	1.359E-1	6.986E-2	7.596E-2	6.656E-2
Average+3σ (Bias1)	---	2.059E-1	2.592E-1	2.366E-1	9.175E-2	1.630E-1	2.385E-1	4.257E-1	1.856E-1	1.499E-1	1.737E-1
Average-3σ (Bias1)	---	-2.019E-1	-3.232E-1	-2.646E-1	-1.877E-1	-2.470E-1	-3.345E-1	-3.897E-1	-2.336E-1	-3.059E-1	-2.257E-1
Average (Bias2)	---	5.200E-2	2.000E-2	1.400E-2	-4.800E-2	-1.600E-2	-6.400E-2	-5.400E-2	-4.400E-2	-7.600E-2	-4.800E-2
σ (Bias2)	---	5.070E-2	4.062E-2	1.193E-1	5.933E-2	6.580E-2	5.983E-2	4.980E-2	7.635E-2	4.561E-2	1.148E-1
Average+3σ (Bias2)	---	2.041E-1	1.419E-1	3.719E-1	1.300E-1	1.814E-1	1.155E-1	9.540E-2	1.851E-1	6.082E-2	2.963E-1
Average-3σ (Bias2)	---	-1.001E-1	-1.019E-1	-3.439E-1	-2.260E-1	-2.134E-1	-2.435E-1	-2.034E-1	-2.731E-1	-2.128E-1	-3.923E-1
Average (OFF)	---	1.000E-2	-8.000E-3	2.000E-3	-1.420E-1	-1.360E-1	-3.400E-2	-9.400E-2	-1.140E-1	-1.220E-1	-2.400E-2
σ (OFF)	---	1.010E-1	1.083E-1	8.167E-2	1.525E-1	8.764E-2	1.627E-1	9.397E-2	9.915E-2	1.197E-1	9.659E-2
Average+3σ (OFF)	---	3.130E-1	3.168E-1	2.470E-1	3.156E-1	1.269E-1	4.542E-1	1.879E-1	1.834E-1	2.370E-1	2.658E-1
Average-3σ (OFF)	---	-2.930E-1	-3.328E-1	-2.430E-1	-5.996E-1	-3.989E-1	-5.222E-1	-3.759E-1	-4.114E-1	-4.810E-1	-3.138E-1

21.TFBack

Ta = 25°C; IF = 10 mA +/- 4 mA; RL = 50 Ohms

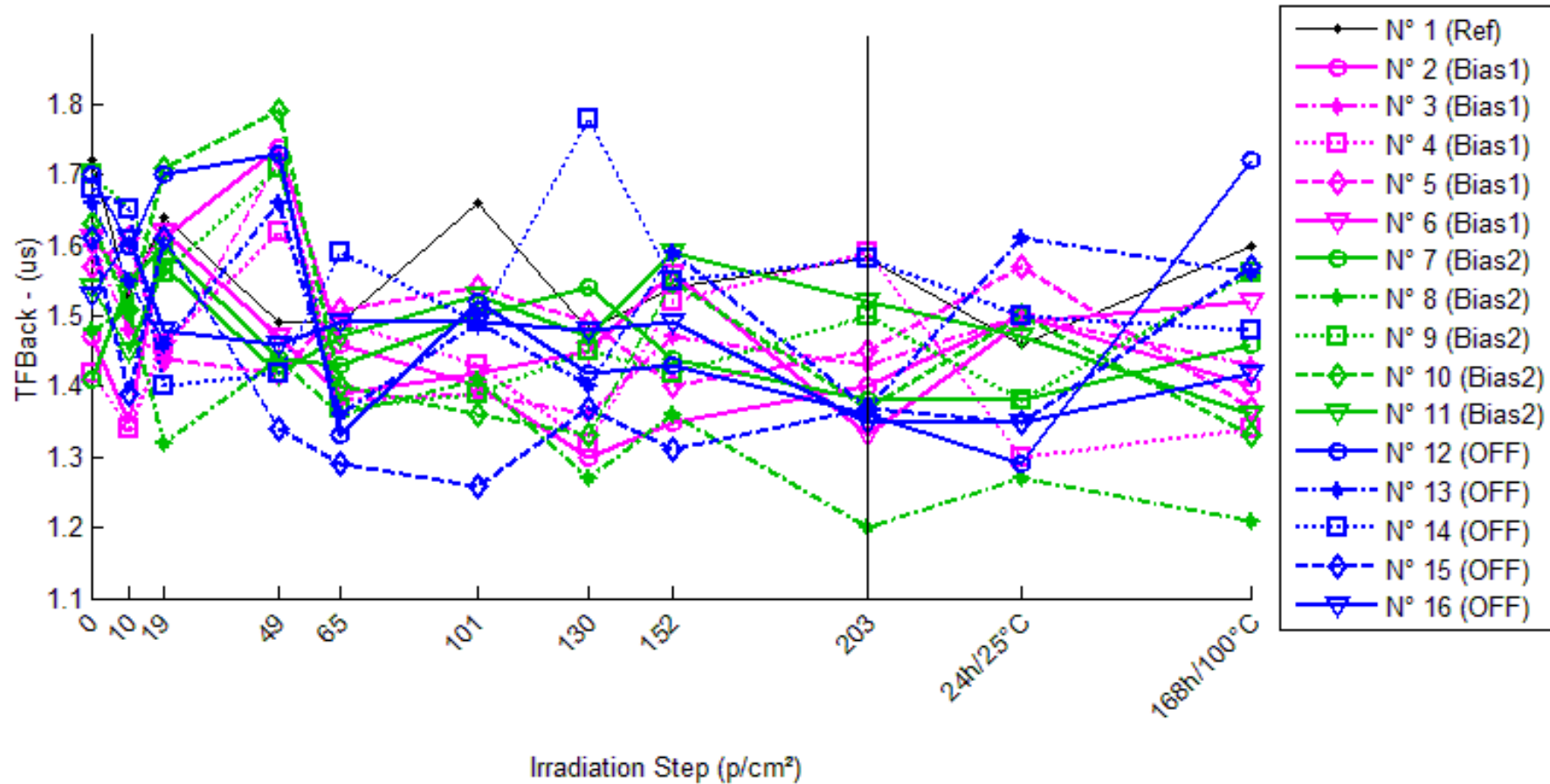

TFBack . (us)

	0krad(Si)	10krad(Si)	19krad(Si)	49krad(Si)	65krad(Si)	101krad(Si)	130krad(Si)	152krad(Si)	203krad(Si)	24h/25°C	168h/100°C
N° 1 (Ref)	1.72	1.53	1.64	1.49	1.49	1.66	1.48	1.54	1.58	1.46	1.60
N° 2 (Bias1)	1.47	1.35	1.61	1.74	1.46	1.40	1.30	1.35	1.40	1.50	1.40
N° 3 (Bias1)	1.60	1.48	1.44	1.72	1.38	1.39	1.36	1.47	1.43	1.50	1.43
N° 4 (Bias1)	1.42	1.34	1.46	1.62	1.49	1.43	1.32	1.52	1.59	1.30	1.34
N° 5 (Bias1)	1.57	1.61	1.44	1.42	1.51	1.54	1.49	1.40	1.45	1.57	1.37
N° 6 (Bias1)	1.61	1.55	1.62	1.47	1.39	1.42	1.45	1.56	1.33	1.49	1.52
N° 7 (Bias2)	1.41	1.55	1.60	1.44	1.43	1.50	1.54	1.44	1.38	1.38	1.46
N° 8 (Bias2)	1.48	1.51	1.32	1.44	1.36	1.41	1.27	1.36	1.20	1.27	1.21
N° 9 (Bias2)	1.70	1.65	1.56	1.71	1.37	1.39	1.45	1.42	1.50	1.38	1.56
N° 10 (Bias2)	1.63	1.51	1.71	1.79	1.40	1.36	1.33	1.55	1.37	1.50	1.33
N° 11 (Bias2)	1.54	1.45	1.57	1.42	1.47	1.53	1.47	1.59	1.52	1.47	1.36
N° 12 (OFF)	1.70	1.60	1.70	1.73	1.33	1.52	1.42	1.43	1.36	1.29	1.72
N° 13 (OFF)	1.66	1.55	1.46	1.66	1.36	1.49	1.40	1.59	1.37	1.61	1.56
N° 14 (OFF)	1.68	1.65	1.40	1.42	1.59	1.49	1.78	1.55	1.58	1.50	1.48
N° 15 (OFF)	1.61	1.39	1.61	1.34	1.29	1.26	1.37	1.31	1.37	1.35	1.57
N° 16 (OFF)	1.53	1.61	1.48	1.46	1.49	1.49	1.48	1.49	1.35	1.35	1.42

Delta [TFBack]

	0krad(Si)	10krad(Si)	19krad(Si)	49krad(Si)	65krad(Si)	101krad(Si)	130krad(Si)	152krad(Si)	203krad(Si)	24h/25°C	168h/100°C
N° 1 (Ref)	---	-1.900E-1	-8.000E-2	-2.300E-1	-2.300E-1	-6.000E-2	-2.400E-1	-1.800E-1	-1.400E-1	-2.600E-1	-1.200E-1
N° 2 (Bias1)	---	-1.200E-1	1.400E-1	2.700E-1	-1.000E-2	-7.000E-2	-1.700E-1	-1.200E-1	-7.000E-2	3.000E-2	-7.000E-2
N° 3 (Bias1)	---	-1.200E-1	-1.600E-1	1.200E-1	-2.200E-1	-2.100E-1	-2.400E-1	-1.300E-1	-1.700E-1	-1.000E-1	-1.700E-1
N° 4 (Bias1)	---	-8.000E-2	4.000E-2	2.000E-1	7.000E-2	1.000E-2	-1.000E-1	1.000E-1	1.700E-1	-1.200E-1	-8.000E-2
N° 5 (Bias1)	---	4.000E-2	-1.300E-1	-1.500E-1	-6.000E-2	-3.000E-2	-8.000E-2	-1.700E-1	-1.200E-1	0.000E+0	-2.000E-1
N° 6 (Bias1)	---	-6.000E-2	1.000E-2	-1.400E-1	-2.200E-1	-1.900E-1	-1.600E-1	-5.000E-2	-2.800E-1	-1.200E-1	-9.000E-2
N° 7 (Bias2)	---	1.400E-1	1.900E-1	3.000E-2	2.000E-2	9.000E-2	1.300E-1	3.000E-2	-3.000E-2	-3.000E-2	5.000E-2
N° 8 (Bias2)	---	3.000E-2	-1.600E-1	-4.000E-2	-1.200E-1	-7.000E-2	-2.100E-1	-1.200E-1	-2.800E-1	-2.100E-1	-2.700E-1
N° 9 (Bias2)	---	-5.000E-2	-1.400E-1	1.000E-2	-3.300E-1	-3.100E-1	-2.500E-1	-2.800E-1	-2.000E-1	-3.200E-1	-1.400E-1
N° 10 (Bias2)	---	-1.200E-1	8.000E-2	1.600E-1	-2.300E-1	-2.700E-1	-3.000E-1	-8.000E-2	-2.600E-1	-1.300E-1	-3.000E-1
N° 11 (Bias2)	---	-9.000E-2	3.000E-2	-1.200E-1	-7.000E-2	-1.000E-2	-7.000E-2	5.000E-2	-2.000E-2	-7.000E-2	-1.800E-1
N° 12 (OFF)	---	-1.000E-1	-2.220E-16	3.000E-2	-3.700E-1	-1.800E-1	-2.800E-1	-2.700E-1	-3.400E-1	-4.100E-1	2.000E-2
N° 13 (OFF)	---	-1.100E-1	-2.000E-1	0.000E+0	-3.000E-1	-1.700E-1	-2.600E-1	-7.000E-2	-2.900E-1	-5.000E-2	-1.000E-1
N° 14 (OFF)	---	-3.000E-2	-2.800E-1	-2.600E-1	-9.000E-2	-1.900E-1	1.000E-1	-1.300E-1	-1.000E-1	-1.800E-1	-2.000E-1
N° 15 (OFF)	---	-2.200E-1	0.000E+0	-2.700E-1	-3.200E-1	-3.500E-1	-2.400E-1	-3.000E-1	-2.400E-1	-2.600E-1	-4.000E-2
N° 16 (OFF)	---	8.000E-2	-5.000E-2	-7.000E-2	-4.000E-2	-4.000E-2	-5.000E-2	-4.000E-2	-1.800E-1	-1.800E-1	-1.100E-1
Average (Bias1)	---	-6.800E-2	-2.000E-2	6.000E-2	-8.800E-2	-9.800E-2	-1.500E-1	-7.400E-2	-9.400E-2	-6.200E-2	-1.220E-1
σ (Bias1)	---	6.573E-2	1.243E-1	1.946E-1	1.291E-1	9.757E-2	6.325E-2	1.064E-1	1.668E-1	7.155E-2	5.891E-2
Average+3σ (Bias1)	---	1.292E-1	3.529E-1	6.437E-1	2.993E-1	1.947E-1	3.974E-2	2.453E-1	4.065E-1	1.527E-1	5.472E-2
Average-3σ (Bias1)	---	-2.652E-1	-3.929E-1	-5.237E-1	-4.753E-1	-3.907E-1	-3.397E-1	-3.933E-1	-5.945E-1	-2.767E-1	-2.987E-1
Average (Bias2)	---	-1.800E-2	0.000E+0	8.000E-3	-1.460E-1	-1.140E-1	-1.400E-1	-8.000E-2	-1.580E-1	-1.520E-1	-1.680E-1
σ (Bias2)	---	1.047E-1	1.488E-1	1.028E-1	1.369E-1	1.711E-1	1.735E-1	1.329E-1	1.250E-1	1.158E-1	1.381E-1
Average+3σ (Bias2)	---	2.962E-1	4.465E-1	3.164E-1	2.646E-1	3.993E-1	3.805E-1	3.186E-1	2.169E-1	1.955E-1	2.463E-1
Average-3σ (Bias2)	---	-3.322E-1	-4.465E-1	-3.004E-1	-5.566E-1	-6.273E-1	-6.605E-1	-4.786E-1	-5.329E-1	-4.995E-1	-5.823E-1
Average (OFF)	---	-7.600E-2	-1.060E-1	-1.140E-1	-2.240E-1	-1.860E-1	-1.460E-1	-1.620E-1	-2.300E-1	-2.160E-1	-8.600E-2
σ (OFF)	---	1.106E-1	1.272E-1	1.426E-1	1.484E-1	1.101E-1	1.655E-1	1.173E-1	9.381E-2	1.320E-1	8.234E-2
Average+3σ (OFF)	---	2.558E-1	2.756E-1	3.137E-1	2.213E-1	1.444E-1	3.504E-1	1.900E-1	5.142E-2	1.801E-1	1.610E-1
Average-3σ (OFF)	---	-4.078E-1	-4.876E-1	-5.417E-1	-6.693E-1	-5.164E-1	-6.424E-1	-5.140E-1	-5.114E-1	-6.121E-1	-3.330E-1