

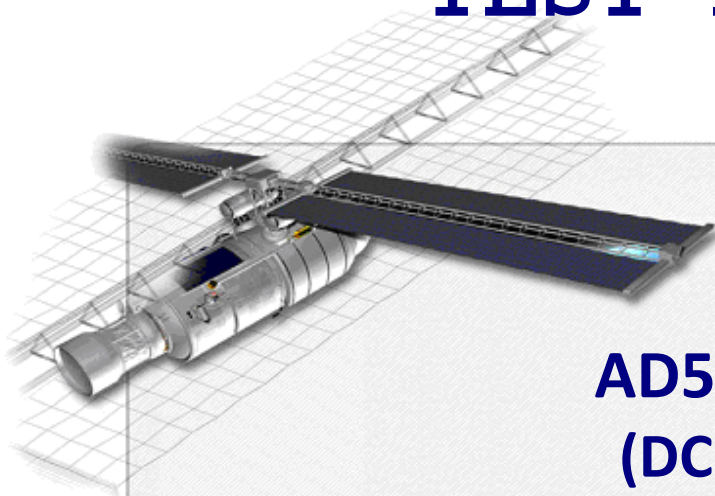

TOTAL IONIZING DOSE TEST REPORT

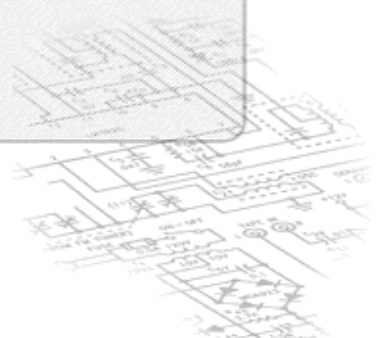

AD558JNZ (DC1116) Voltage-Output 8-Bit Digital-to-Analog Converter From Analog Devices



TRAD/TE/AD558JNZ/1116/ESA/LG/1409		Labège, 23 June 2015
 		TRAD, Bât Gallium 907, Voie l'Occitane - 31670 LABEGE France ☎ : 05 61 00 95 60 Fax: 05 61 00 95 61 Email: trad@trad.fr Web Site: www.trad.fr SIRET 397 862 038 00056 - TVA FR59397862038
Written by	Verified by / Quality control	Approved by
L. SALVY 15/07/2015	L. GOUYET 15/07/2015	A. ROUSSET 15/07/2015
Revision: 0		
To: ESA Marc POIZAT	Project/Program: Ref:	

CONTENTS

1. Introduction.....	3
2. Documents	3
2.1. Applicable documents	3
2.2. Reference documents.....	3
3. Part information	3
3.1. Identification.....	3
3.2. Procurement information	3
3.3. Sample pictures.....	4
3.3.1. External view	4
3.3.2. Internal view	4
4. Dosimetry and irradiation facility.....	5
4.1. Irradiation facility.....	5
4.2. Irradiation time log	5
5. Bias setup	6
5.1. Parts distribution	6
5.2. Bias condition.....	6
5.3. Bias equipment identification	6
6. Test setup	7
6.1. Test parameters.....	7
6.2. Test equipment identification.....	7
7. Non conformance.....	7
8. Results	8
8.1. Presentation of the results	8
8.2. Drift of the parameters.....	8
8.2.1. Parts biased ON	9
8.2.2. Parts biased OFF	9
8.2.3. Technical comments.....	9
9. Conclusion	10
10. Appendix 1 measured parameters.....	11

FIGURES

Figure 1: Package marking.....	4
Figure 2: Internal overall view	4
Figure 3: Die marking	4
Figure 4: Bias Condition.....	6

1. INTRODUCTION

This report describes the testing and characterization of the **AD558JNZ** manufactured by **Analog Devices**. Irradiations began on 23 January 2015 and ended on 21 April 2015.

2. DOCUMENTS

2.1. Applicable documents

- Financial and technical proposal: TRAD/P/ESA/AO7751/AV/130214 Rev.0
- Irradiation test plan: ITP/TRA/TE/AD558/XXX/AD/240714

2.2. Reference documents

- Basic specification: ESCC N°22900 Issue 4 of October 2010
- Data-sheet: AD558 Datasheet from Analog Devices Rev. A

3. PART INFORMATION

3.1. Identification

Part designation	AD558JNZ
Manufacturer	Analog Devices
Part function	Voltage-Output 8-Bit Digital-to-Analog Converter

3.2. Procurement information

Package	DIL-16
Date code	1116
Number of tested parts	10 irradiated samples + 1 reference sample

3.3. Sample pictures

3.3.1. External view

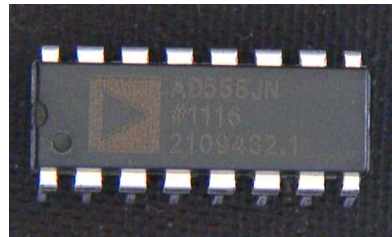

Figure 1: Package marking

3.3.2. Internal view

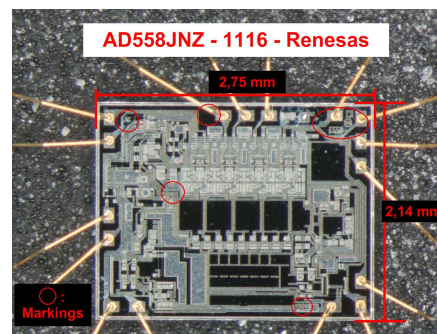

Figure 2: Internal overall view

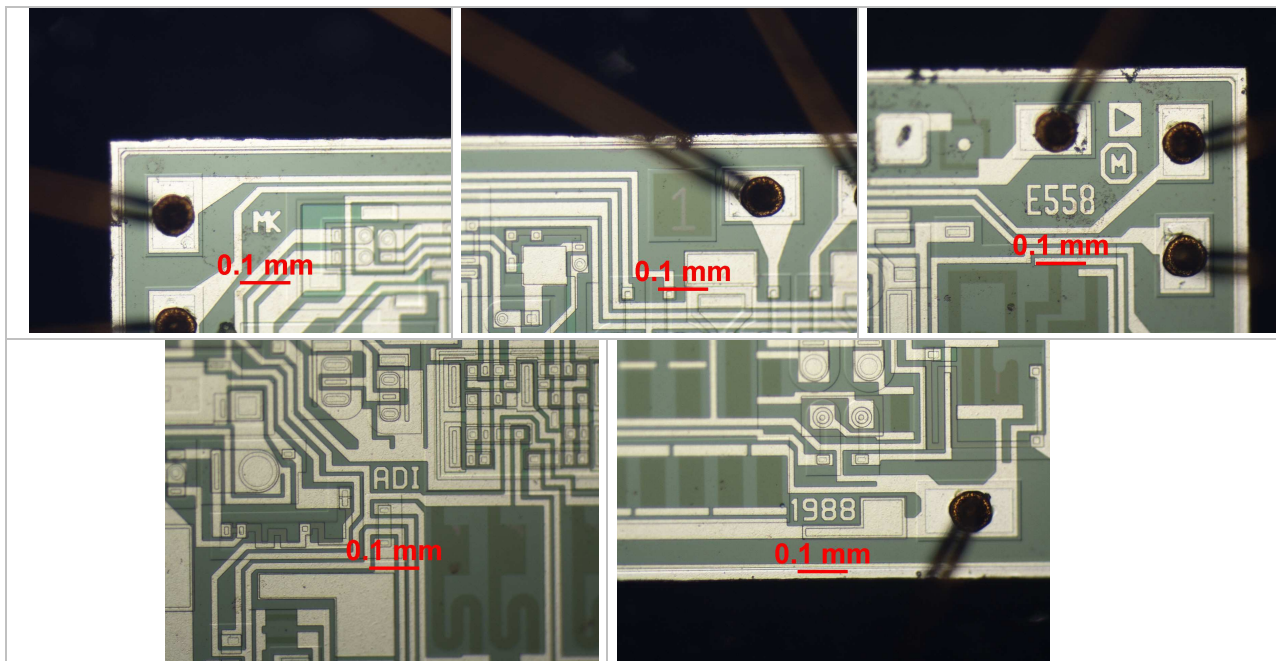

Figure 3: Die marking

4. DOSIMETRY AND IRRADIATION FACILITY

4.1. Irradiation facility

Irradiation source	⁶⁰ Co
Source location	U.C.L (Louvain-la-Neuve)
Irradiation equipment	GIF
Dosimetry equipment	PTW Ionization chamber

4.2. Irradiation time log

Total dose limit (krad(Si))	150				
Levels for measurements (krad(Si))	0	41	78	114	150
Dose rate (rad(Si)/h)	74				

5. BIAS SETUP

All irradiated components are biased under the following conditions. One component is not irradiated to act as a *REFERENCE*. All the parameters specified in the applicable ITP are measured on the *REFERENCE* and irradiated components.

5.1. Parts distribution

Serial number	Reference	Samples irradiated									
TRAD mark	1	2	3	4	5	6	7	8	9	10	11
Bias mode	REF	ON	ON	ON	ON	ON	OFF	OFF	OFF	OFF	OFF

5.2. Bias condition

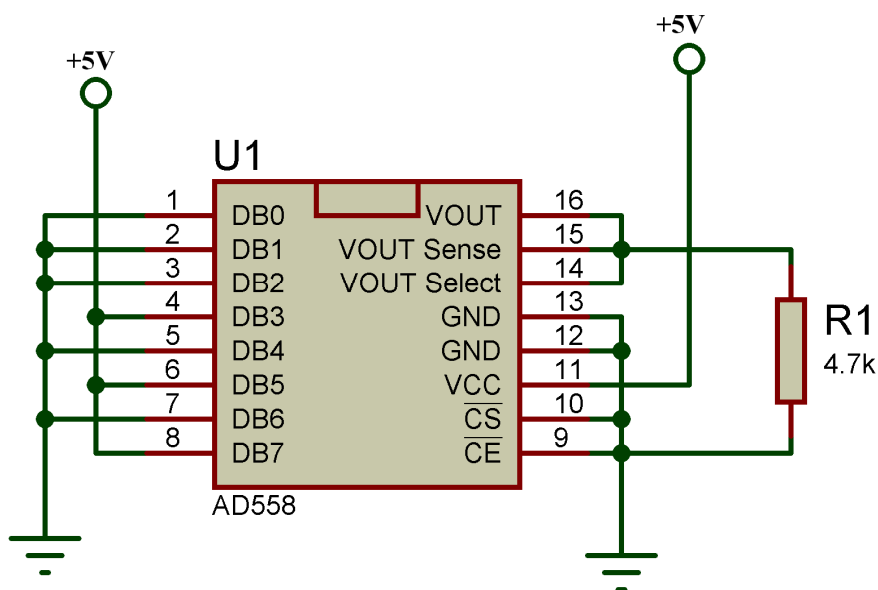

Figure 4: Bias Condition

5.3. Bias equipment identification

Bias board	TRAD/CP1/E/AD558/DIL16/LS/1407
Equipment	AR-69

6. TEST SETUP

6.1. Test parameters

Parameters	Symbols	Test conditions
Ta = 25°C, Vcc = 5V, unless otherwise specified		
Relative Accuracy	INL	
Differential Non Linearity	DNL	
Zero Error	Vze	
Gain Error	FSA	
Power Supply Current	Icc	All bits on
Digital Input High Voltage	Vih	
Digital Input Low Voltage	Vil	
Digital Input High Current	Iih	Vin = 5V
Digital Input Low Current	Iil	Vin = 0V

6.2. Test equipment identification

Test board	TRAD/CT1/E/AD558/DIL16/FW/1003
Equipment	MI-09; SM-22; ME-20; ME-59; ME-04; MI-08
Test program	AD558_TE_XXX1_B2_V10 to V30

7. NON CONFORMANCE

Test and measurement conditions were nominal.

8. RESULTS

8.1. Presentation of the results

For each parameter:

- The measurements performed at each irradiation step are registered in a table.
- Drifts between each measurement step and the "0" krad(Si) step are computed.

NB : * For the **CTR** and the **Hfe** parameters, the formula used is :

$$Drift = \frac{1}{measurement(Xkrad(Si))} - \frac{1}{measurement(0krad(Si))}$$

* For the **other measurements**, the formula used is:



$$Drift = measurement(Xkrad(Si)) - measurement(0krad(Si))$$

Where X stands for each measurement step.

8.2. Drift of the parameters

The next representations show, for each parameter, the irradiation step for which a first component of the lot is out of specification or not measurable.

The legend of these representations is given hereunder.

	Within specification
	Transition
	Out of specification parameter or parameter not measurable

8.2.1. Parts biased ON

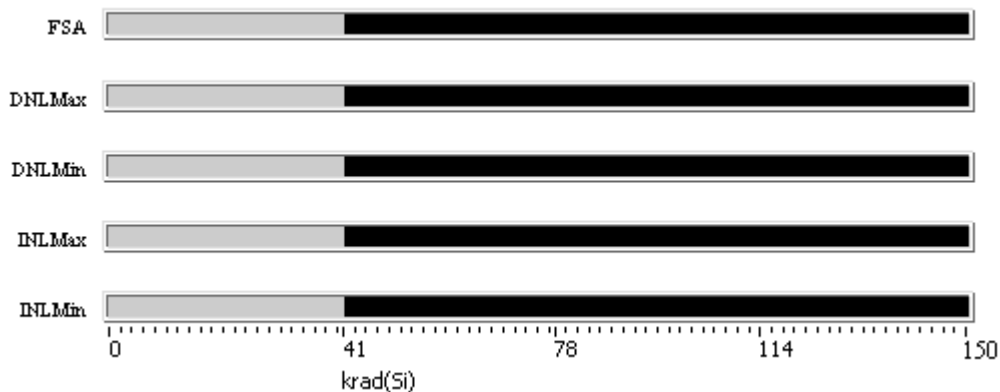

The parameter INLMMax is out of specification at 10.8 krad(Si) by interpolation.
 The parameter INLMIn is out of specification at 16.5 krad(Si) by interpolation.
 The parameter DNLMMax is out of specification at 20.7 krad(Si) by interpolation.
 The parameter FSA is out of specification at 30.5 krad(Si) by interpolation.
 The parameter DNLMIn is out of specification at 36.0 krad(Si) by interpolation.

8.2.2. Parts biased OFF

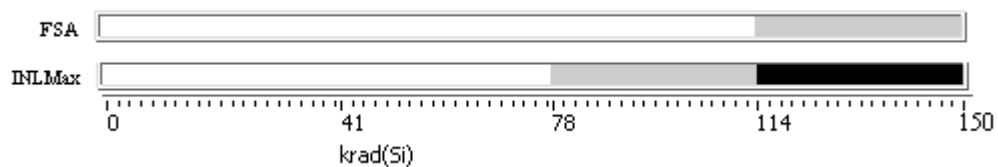

The parameter INLMMax is out of specification at 99.1 krad(Si) by interpolation.
 The parameter FSA is out of specification at 125.1 krad(Si) by interpolation.

8.2.3. Technical comments

No atypical behaviour during the test to report.

9. CONCLUSION

The total dose steady-state irradiation test using gamma rays from Cobalt 60 source has been carried out on **10 AD558JNZ**, a **Voltage-Output 8-Bit Digital-to-Analog Converter** from **Analog Devices** up to **150 krad(Si)** at low dose rate (74 rad(Si)/h).

Hereunder our comments:

No failure observed on the DUTs at total dose level.

10. APPENDIX 1 MEASURED PARAMETERS

Contents :

1 INLMax	A-3
2 INLMin	A-4
3 DNLMMax	A-5
4 DNLMMin	A-6
5 Vze	A-7
6 FSA	A-8
7 Icc	A-9
8 Vih_DB0	A-10
9 Vih_DB1	A-11
10 Vih_DB2	A-12
11 Vih_DB3	A-13
12 Vih_DB4	A-14
13 Vih_DB5	A-15
14 Vih_DB6	A-16
15 Vih_DB7	A-17
16 Vih_CS	A-18
17 Vih_CE	A-19
18 Vil_DB0	A-20
19 Vil_DB1	A-21
20 Vil_DB2	A-22
21 Vil_DB3	A-23
22 Vil_DB4	A-24
23 Vil_DB5	A-25
24 Vil_DB6	A-26
25 Vil_DB7	A-27
26 Vil_CS	A-28
27 Vil_CE	A-29
28 lih_DB0	A-30
29 lih_DB1	A-31
30 lih_DB2	A-32
31 lih_DB3	A-33
32 lih_DB4	A-34
33 lih_DB5	A-35
34 lih_DB6	A-36
35 lih_DB7	A-37

Contents :

36 lih_CS	A-38
37 lih_CE	A-39
38 lil_DB0	A-40
39 lil_DB1	A-41
40 lil_DB2	A-42
41 lil_DB3	A-43
42 lil_DB4	A-44
43 lil_DB5	A-45
44 lil_DB6	A-46
45 lil_DB7	A-47
46 lil_CS	A-48
47 lil_CE	A-49

1. INLMax

Ta= 25°C ; Vcc = 5V

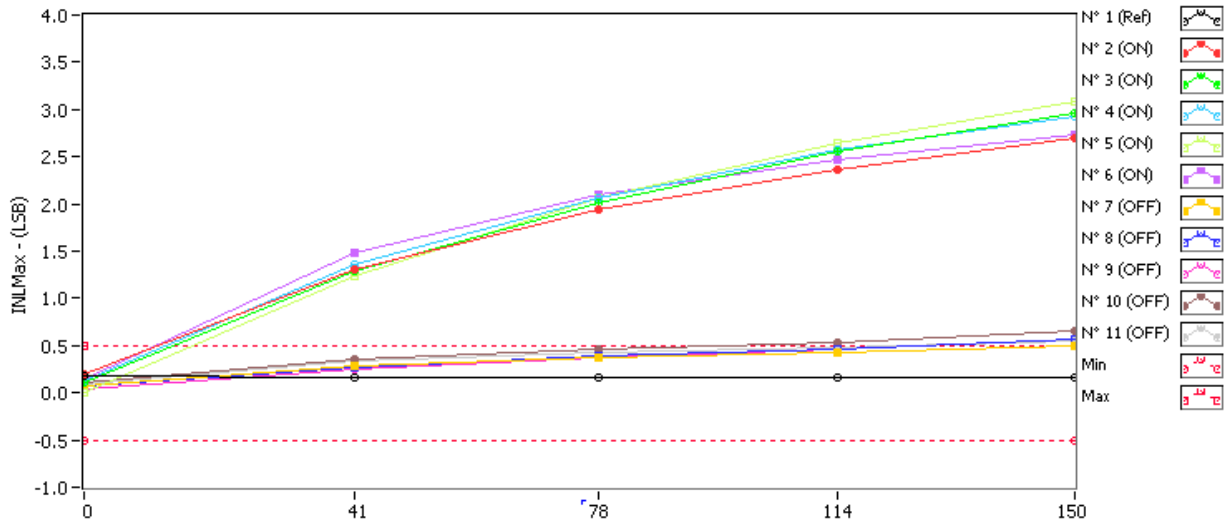

INLMax . (LSB) Min = -0.5 Max = 0.5

	0krad(Si)	41krad(Si)	78krad(Si)	114krad(Si)	150krad(Si)
N° 1 (Ref)	0.171	0.168	0.166	0.165	0.164
N° 2 (ON)	0.196	1.314	1.949	2.371	2.695
N° 3 (ON)	0.110	1.284	2.017	2.557	2.955
N° 4 (ON)	0.127	1.352	2.057	2.566	2.935
N° 5 (ON)	0.009	1.237	2.060	2.638	3.076
N° 6 (ON)	0.151	1.477	2.097	2.476	2.729
N° 7 (OFF)	0.069	0.288	0.369	0.427	0.497
N° 8 (OFF)	0.070	0.276	0.397	0.470	0.566
N° 9 (OFF)	0.044	0.243	0.373	0.456	0.566
N° 10 (OFF)	0.111	0.353	0.459	0.529	0.656
N° 11 (OFF)	0.091	0.345	0.421	0.476	0.541

Delta [INLMax]

	0krad(Si)	41krad(Si)	78krad(Si)	114krad(Si)	150krad(Si)
N° 1 (Ref)	---	-3.273E-3	-4.663E-3	-5.997E-3	-7.053E-3
N° 2 (ON)	---	1.118E+0	1.753E+0	2.175E+0	2.499E+0
N° 3 (ON)	---	1.174E+0	1.907E+0	2.448E+0	2.846E+0
N° 4 (ON)	---	1.225E+0	1.930E+0	2.438E+0	2.807E+0
N° 5 (ON)	---	1.228E+0	2.051E+0	2.629E+0	3.067E+0
N° 6 (ON)	---	1.326E+0	1.946E+0	2.325E+0	2.578E+0
N° 7 (OFF)	---	2.198E-1	3.002E-1	3.584E-1	4.289E-1
N° 8 (OFF)	---	2.059E-1	3.276E-1	3.997E-1	4.964E-1
N° 9 (OFF)	---	1.997E-1	3.293E-1	4.122E-1	5.221E-1
N° 10 (OFF)	---	2.425E-1	3.478E-1	4.185E-1	5.454E-1
N° 11 (OFF)	---	2.544E-1	3.306E-1	3.852E-1	4.508E-1
Average (ON)	---	1.214E+0	1.918E+0	2.403E+0	2.759E+0
s (ON)	---	7.684E-2	1.072E-1	1.675E-1	2.263E-1
Average+3s (ON)	---	1.445E+0	2.239E+0	2.905E+0	3.438E+0
Average-3s (ON)	---	9.838E-1	1.596E+0	1.900E+0	2.080E+0
Average (OFF)	---	2.244E-1	3.271E-1	3.948E-1	4.887E-1
s (OFF)	---	2.347E-2	1.709E-2	2.398E-2	4.848E-2
Average+3s (OFF)	---	2.948E-1	3.784E-1	4.667E-1	6.342E-1
Average-3s (OFF)	---	1.540E-1	2.758E-1	3.229E-1	3.433E-1

2. INLMin

Ta= 25°C ; Vcc = 5V

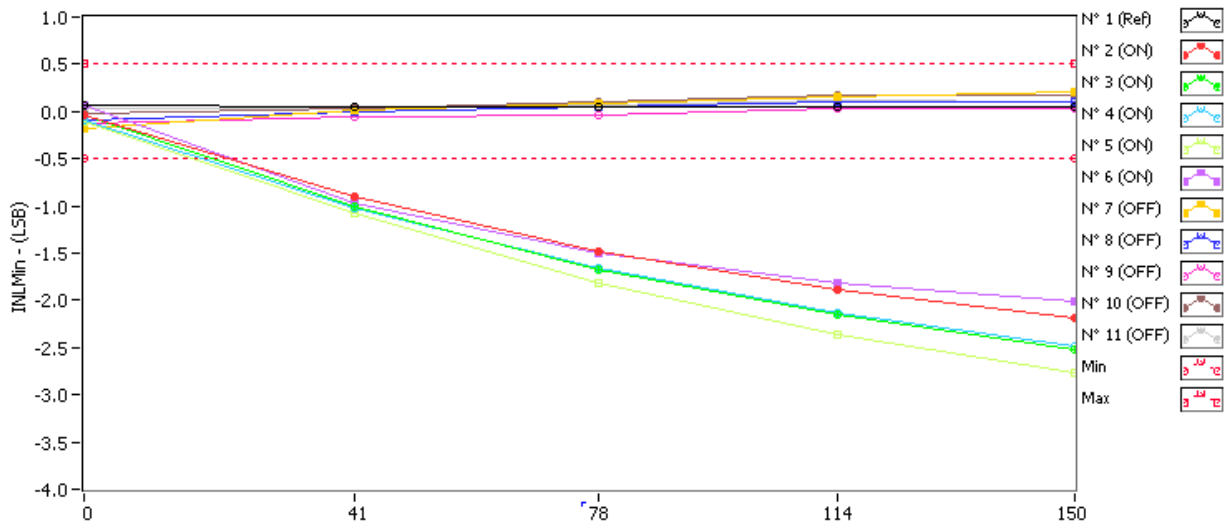

INLMin . (LSB) Min = -0.5 Max = 0.5

	0krad(Si)	41krad(Si)	78krad(Si)	114krad(Si)	150krad(Si)
N° 1 (Ref)	0.059	0.058	0.058	0.057	0.058
N° 2 (ON)	-0.034	-0.906	-1.477	-1.883	-2.192
N° 3 (ON)	-0.046	-1.013	-1.671	-2.144	-2.520
N° 4 (ON)	-0.099	-1.021	-1.666	-2.127	-2.486
N° 5 (ON)	-0.111	-1.080	-1.816	-2.356	-2.761
N° 6 (ON)	0.070	-0.974	-1.501	-1.810	-2.017
N° 7 (OFF)	-0.173	0.021	0.089	0.160	0.201
N° 8 (OFF)	-0.100	0.003	0.043	0.102	0.104
N° 9 (OFF)	-0.134	-0.064	-0.032	0.037	0.032
N° 10 (OFF)	-0.018	0.032	0.098	0.177	0.176
N° 11 (OFF)	0.033	0.025	0.061	0.122	0.097

Delta [INLMin]

	0krad(Si)	41krad(Si)	78krad(Si)	114krad(Si)	150krad(Si)
N° 1 (Ref)	---	-5.262E-4	-7.740E-4	-1.517E-3	-7.405E-4
N° 2 (ON)	---	-8.730E-1	-1.443E+0	-1.850E+0	-2.158E+0
N° 3 (ON)	---	-9.665E-1	-1.625E+0	-2.098E+0	-2.474E+0
N° 4 (ON)	---	-9.216E-1	-1.566E+0	-2.028E+0	-2.387E+0
N° 5 (ON)	---	-9.691E-1	-1.705E+0	-2.245E+0	-2.650E+0
N° 6 (ON)	---	-1.045E+0	-1.571E+0	-1.880E+0	-2.088E+0
N° 7 (OFF)	---	1.933E-1	2.619E-1	3.323E-1	3.738E-1
N° 8 (OFF)	---	1.032E-1	1.432E-1	2.016E-1	2.041E-1
N° 9 (OFF)	---	6.983E-2	1.024E-1	1.714E-1	1.662E-1
N° 10 (OFF)	---	4.954E-2	1.158E-1	1.951E-1	1.940E-1
N° 11 (OFF)	---	-8.005E-3	2.743E-2	8.872E-2	6.391E-2
Average (ON)	---	-9.550E-1	-1.582E+0	-2.020E+0	-2.351E+0
s (ON)	---	6.368E-2	9.556E-2	1.622E-1	2.304E-1
Average+3s (ON)	---	-7.639E-1	-1.295E+0	-1.534E+0	-1.660E+0
Average-3s (ON)	---	-1.146E+0	-1.869E+0	-2.507E+0	-3.043E+0
Average (OFF)	---	8.157E-2	1.301E-1	1.978E-1	2.004E-1
s (OFF)	---	7.438E-2	8.522E-2	8.762E-2	1.117E-1
Average+3s (OFF)	---	3.047E-1	3.858E-1	4.607E-1	5.356E-1
Average-3s (OFF)	---	-1.416E-1	-1.255E-1	-6.504E-2	-1.347E-1

3. DNLMMax

Ta= 25°C ; Vcc = 5V

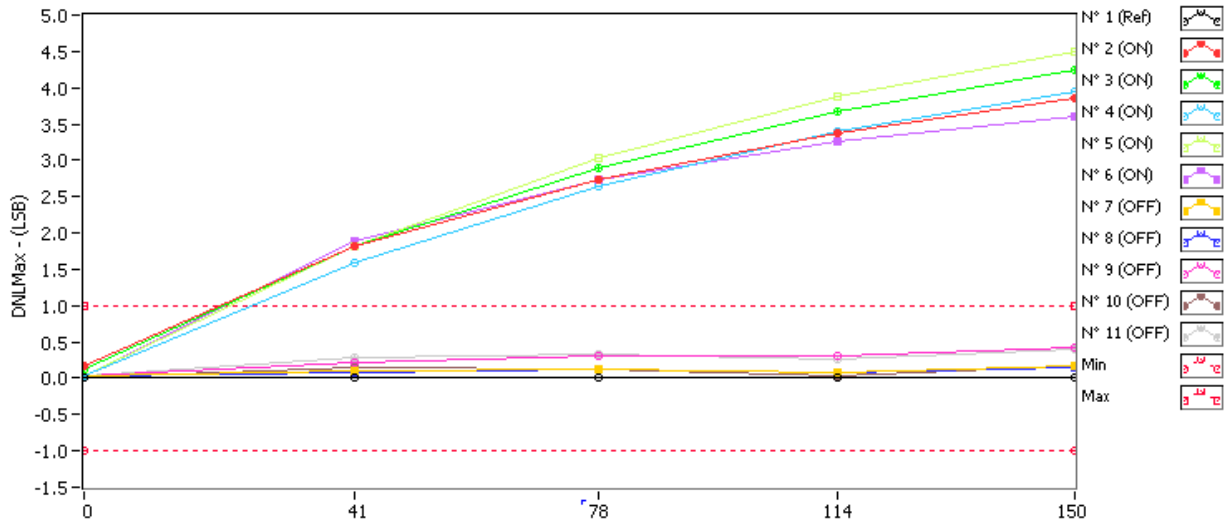

DNLMMax . (LSB) Min = -1.0 Max = 1.0

	0krad(Si)	41krad(Si)	78krad(Si)	114krad(Si)	150krad(Si)
N° 1 (Ref)	0.020	0.019	0.018	0.018	0.018
N° 2 (ON)	0.172	1.814	2.735	3.366	3.850
N° 3 (ON)	0.136	1.826	2.887	3.664	4.254
N° 4 (ON)	0.039	1.599	2.641	3.392	3.951
N° 5 (ON)	0.025	1.827	3.032	3.873	4.507
N° 6 (ON)	0.029	1.878	2.744	3.260	3.611
N° 7 (OFF)	0.036	0.093	0.121	0.076	0.162
N° 8 (OFF)	0.026	0.090	0.122	0.080	0.146
N° 9 (OFF)	0.028	0.212	0.306	0.314	0.432
N° 10 (OFF)	0.019	0.152	0.136	0.039	0.180
N° 11 (OFF)	0.023	0.285	0.320	0.271	0.392

Delta [DNLMMax]

	0krad(Si)	41krad(Si)	78krad(Si)	114krad(Si)	150krad(Si)
N° 1 (Ref)	---	-1.442E-3	-2.138E-3	-2.121E-3	-2.356E-3
N° 2 (ON)	---	1.642E+0	2.562E+0	3.194E+0	3.678E+0
N° 3 (ON)	---	1.690E+0	2.751E+0	3.528E+0	4.118E+0
N° 4 (ON)	---	1.559E+0	2.602E+0	3.353E+0	3.912E+0
N° 5 (ON)	---	1.802E+0	3.007E+0	3.848E+0	4.482E+0
N° 6 (ON)	---	1.849E+0	2.715E+0	3.231E+0	3.582E+0
N° 7 (OFF)	---	5.650E-2	8.459E-2	3.967E-2	1.254E-1
N° 8 (OFF)	---	6.483E-2	9.609E-2	5.485E-2	1.201E-1
N° 9 (OFF)	---	1.832E-1	2.776E-1	2.854E-1	4.039E-1
N° 10 (OFF)	---	1.330E-1	1.171E-1	1.966E-2	1.608E-1
N° 11 (OFF)	---	2.618E-1	2.974E-1	2.484E-1	3.688E-1
Average (ON)	---	1.709E+0	2.727E+0	3.431E+0	3.954E+0
s (ON)	---	1.178E-1	1.744E-1	2.674E-1	3.613E-1
Average+3s (ON)	---	2.062E+0	3.251E+0	4.233E+0	5.038E+0
Average-3s (ON)	---	1.355E+0	2.204E+0	2.629E+0	2.870E+0
Average (OFF)	---	1.398E-1	1.745E-1	1.296E-1	2.358E-1
s (OFF)	---	8.567E-2	1.040E-1	1.266E-1	1.389E-1
Average+3s (OFF)	---	3.969E-1	4.865E-1	5.095E-1	6.525E-1
Average-3s (OFF)	---	-1.172E-1	-1.374E-1	-2.503E-1	-1.809E-1

4. DNLMIn

Ta= 25°C ; Vcc = 5V

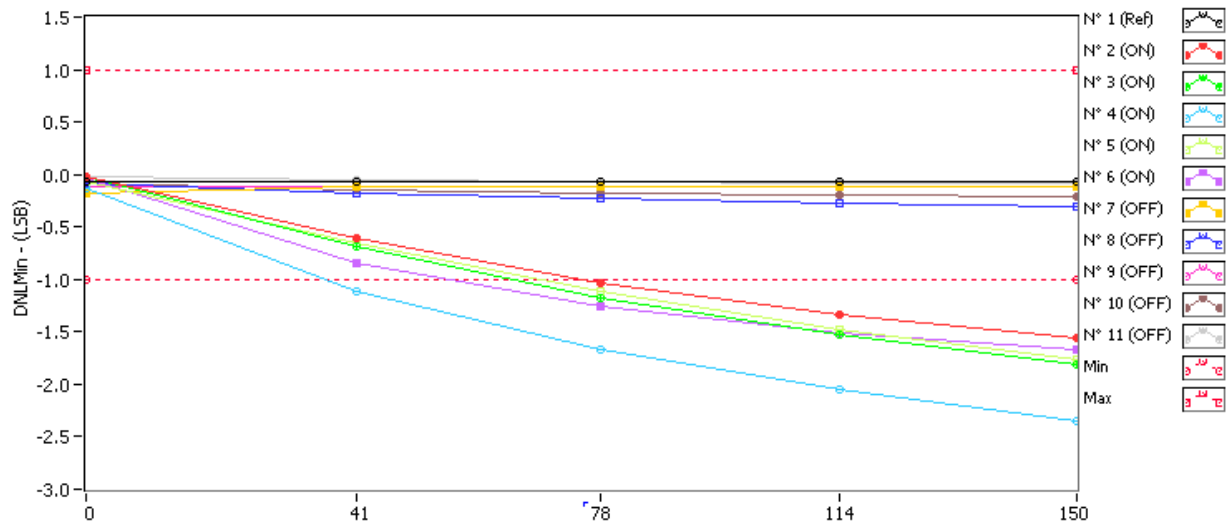

DNLMIn . (LSB) Min = -1.0 Max = 1.0

	0krad(Si)	41krad(Si)	78krad(Si)	114krad(Si)	150krad(Si)
N° 1 (Ref)	-0.068	-0.066	-0.064	-0.064	-0.063
N° 2 (ON)	-0.024	-0.605	-1.038	-1.337	-1.562
N° 3 (ON)	-0.014	-0.687	-1.180	-1.534	-1.811
N° 4 (ON)	-0.138	-1.119	-1.666	-2.057	-2.348
N° 5 (ON)	-0.069	-0.658	-1.122	-1.477	-1.760
N° 6 (ON)	-0.036	-0.846	-1.257	-1.504	-1.663
N° 7 (OFF)	-0.174	-0.114	-0.114	-0.112	-0.113
N° 8 (OFF)	-0.092	-0.182	-0.232	-0.273	-0.310
N° 9 (OFF)	-0.110	-0.110	-0.112	-0.115	-0.113
N° 10 (OFF)	-0.077	-0.146	-0.179	-0.195	-0.219
N° 11 (OFF)	-0.020	-0.058	-0.073	-0.081	-0.089

Delta [DNLMIn]

	0krad(Si)	41krad(Si)	78krad(Si)	114krad(Si)	150krad(Si)
N° 1 (Ref)	---	1.969E-3	4.045E-3	3.377E-3	4.796E-3
N° 2 (ON)	---	-5.806E-1	-1.014E+0	-1.312E+0	-1.538E+0
N° 3 (ON)	---	-6.727E-1	-1.167E+0	-1.520E+0	-1.797E+0
N° 4 (ON)	---	-9.805E-1	-1.528E+0	-1.919E+0	-2.210E+0
N° 5 (ON)	---	-5.896E-1	-1.053E+0	-1.409E+0	-1.692E+0
N° 6 (ON)	---	-8.098E-1	-1.221E+0	-1.468E+0	-1.627E+0
N° 7 (OFF)	---	6.000E-2	6.086E-2	6.282E-2	6.188E-2
N° 8 (OFF)	---	-8.987E-2	-1.397E-1	-1.806E-1	-2.178E-1
N° 9 (OFF)	---	-5.120E-2	-2.143E-3	-4.435E-3	-3.098E-3
N° 10 (OFF)	---	-6.888E-2	-1.021E-1	-1.180E-1	-1.418E-1
N° 11 (OFF)	---	-3.775E-2	-5.285E-2	-6.158E-2	-6.953E-2
Average (ON)	---	-7.267E-1	-1.197E+0	-1.525E+0	-1.773E+0
s (ON)	---	1.691E-1	2.034E-1	2.329E-1	2.622E-1
Average+3s (ON)	---	-2.193E-1	-5.866E-1	-8.268E-1	-9.861E-1
Average-3s (ON)	---	-1.234E+0	-1.807E+0	-2.224E+0	-2.559E+0
Average (OFF)	---	-2.731E-2	-4.719E-2	-6.036E-2	-7.407E-2
s (OFF)	---	5.941E-2	7.955E-2	9.498E-2	1.104E-1
Average+3s (OFF)	---	1.509E-1	1.915E-1	2.246E-1	2.573E-1
Average-3s (OFF)	---	-2.055E-1	-2.858E-1	-3.453E-1	-4.054E-1

5. Vze

Ta= 25°C ; Vcc = 5V

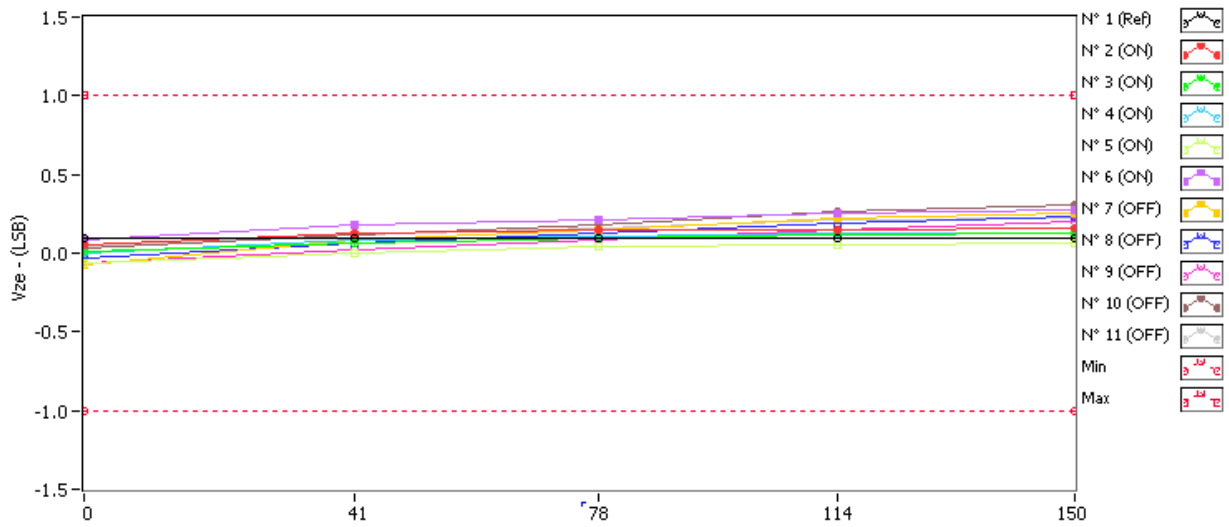

Vze . (LSB) Min = -1.0 Max = 1.0

	0krad(Si)	41krad(Si)	78krad(Si)	114krad(Si)	150krad(Si)
N° 1 (Ref)	0.096	0.096	0.095	0.094	0.094
N° 2 (ON)	0.056	0.127	0.149	0.151	0.159
N° 3 (ON)	0.006	0.063	0.093	0.121	0.130
N° 4 (ON)	0.003	0.086	0.103	0.126	0.131
N° 5 (ON)	-0.066	0.005	0.039	0.056	0.067
N° 6 (ON)	0.084	0.178	0.215	0.250	0.271
N° 7 (OFF)	-0.069	0.086	0.151	0.222	0.257
N° 8 (OFF)	-0.029	0.065	0.126	0.190	0.231
N° 9 (OFF)	-0.062	0.023	0.084	0.152	0.200
N° 10 (OFF)	0.031	0.120	0.182	0.259	0.309
N° 11 (OFF)	0.039	0.116	0.159	0.206	0.226

Delta [Vze]

	0krad(Si)	41krad(Si)	78krad(Si)	114krad(Si)	150krad(Si)
N° 1 (Ref)	---	-2.620E-4	-1.659E-3	-2.801E-3	-2.652E-3
N° 2 (ON)	---	7.059E-2	9.221E-2	9.507E-2	1.021E-1
N° 3 (ON)	---	5.656E-2	8.674E-2	1.140E-1	1.238E-1
N° 4 (ON)	---	8.307E-2	1.004E-1	1.233E-1	1.277E-1
N° 5 (ON)	---	7.084E-2	1.046E-1	1.224E-1	1.334E-1
N° 6 (ON)	---	9.352E-2	1.305E-1	1.654E-1	1.867E-1
N° 7 (OFF)	---	1.550E-1	2.199E-1	2.913E-1	3.263E-1
N° 8 (OFF)	---	9.380E-2	1.552E-1	2.188E-1	2.602E-1
N° 9 (OFF)	---	8.454E-2	1.460E-1	2.134E-1	2.622E-1
N° 10 (OFF)	---	8.942E-2	1.516E-1	2.283E-1	2.787E-1
N° 11 (OFF)	---	7.756E-2	1.198E-1	1.673E-1	1.874E-1
Average (ON)	---	7.491E-2	1.029E-1	1.240E-1	1.348E-1
s (ON)	---	1.401E-2	1.692E-2	2.574E-2	3.138E-2
Average+3s (ON)	---	1.169E-1	1.537E-1	2.013E-1	2.289E-1
Average-3s (ON)	---	3.289E-2	5.212E-2	4.681E-2	4.064E-2
Average (OFF)	---	1.001E-1	1.585E-1	2.238E-1	2.630E-1
s (OFF)	---	3.131E-2	3.699E-2	4.445E-2	4.993E-2
Average+3s (OFF)	---	1.940E-1	2.695E-1	3.572E-1	4.128E-1
Average-3s (OFF)	---	6.136E-3	4.753E-2	9.045E-2	1.132E-1

6. FSA

Ta= 25°C ; Vcc = 5V

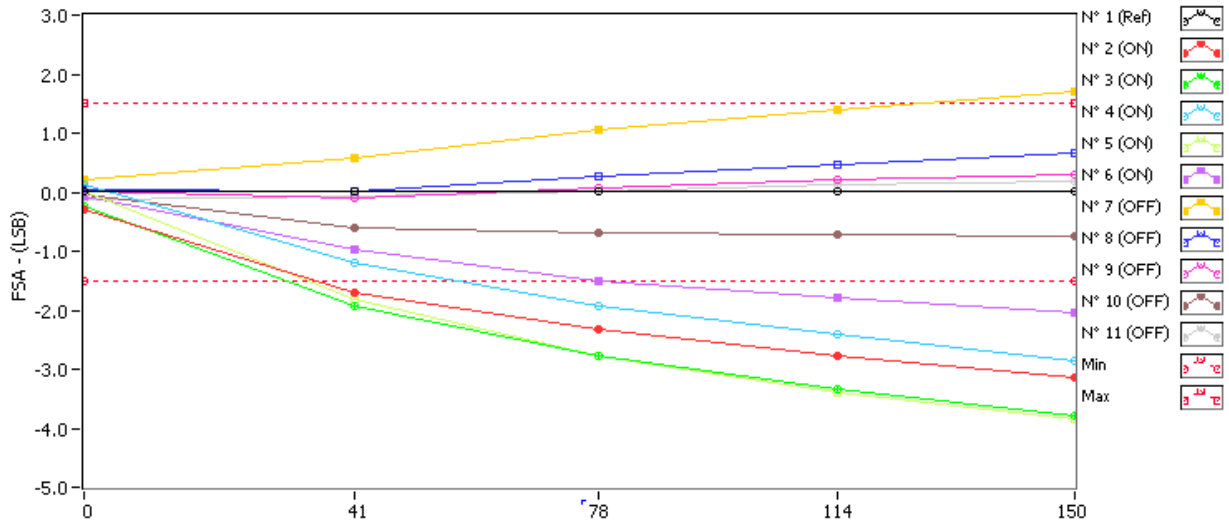

FSA . (LSB) Min = -1.5 Max = 1.5

	0krad(Si)	41krad(Si)	78krad(Si)	114krad(Si)	150krad(Si)
N° 1 (Ref)	0.019	0.011	0.004	0.007	0.000
N° 2 (ON)	-0.285	-1.693	-2.314	-2.775	-3.131
N° 3 (ON)	-0.249	-1.932	-2.775	-3.339	-3.794
N° 4 (ON)	0.117	-1.185	-1.917	-2.421	-2.851
N° 5 (ON)	0.018	-1.816	-2.786	-3.394	-3.837
N° 6 (ON)	-0.074	-0.984	-1.509	-1.798	-2.032
N° 7 (OFF)	0.201	0.585	1.043	1.406	1.710
N° 8 (OFF)	0.053	0.006	0.278	0.470	0.649
N° 9 (OFF)	0.025	-0.104	0.064	0.218	0.308
N° 10 (OFF)	-0.056	-0.602	-0.682	-0.732	-0.733
N° 11 (OFF)	-0.122	-0.083	0.018	0.130	0.172

Delta [FSA]

	0krad(Si)	41krad(Si)	78krad(Si)	114krad(Si)	150krad(Si)
N° 1 (Ref)	---	---	---	---	---
N° 2 (ON)	---	-7.280E-3	-1.457E-2	-1.173E-2	-1.821E-2
N° 3 (ON)	---	-1.408E+0	-2.029E+0	-2.490E+0	-2.846E+0
N° 4 (ON)	---	-1.683E+0	-2.527E+0	-3.091E+0	-3.545E+0
N° 5 (ON)	---	-1.302E+0	-2.034E+0	-2.537E+0	-2.968E+0
N° 6 (ON)	---	-1.834E+0	-2.804E+0	-3.412E+0	-3.855E+0
N° 7 (OFF)	---	-9.102E-1	-1.435E+0	-1.724E+0	-1.958E+0
N° 8 (OFF)	---	3.837E-1	8.424E-1	1.205E+0	1.509E+0
N° 9 (OFF)	---	-4.693E-2	2.247E-1	4.165E-1	5.952E-1
N° 10 (OFF)	---	-1.296E-1	3.833E-2	1.929E-1	2.830E-1
N° 11 (OFF)	---	-5.466E-1	-6.260E-1	-6.762E-1	-6.776E-1
Average (ON)	---	-1.428E+0	-2.166E+0	-2.651E+0	-3.034E+0
s (ON)	---	3.586E-1	5.262E-1	6.463E-1	7.299E-1
Average+3s (ON)	---	-3.518E-1	-5.873E-1	-7.120E-1	-8.447E-1
Average-3s (ON)	---	-2.503E+0	-3.744E+0	-4.590E+0	-5.224E+0
Average (OFF)	---	-6.006E-2	1.239E-1	2.780E-1	4.007E-1
s (OFF)	---	3.348E-1	5.235E-1	6.703E-1	7.834E-1
Average+3s (OFF)	---	9.445E-1	1.694E+0	2.289E+0	2.751E+0
Average-3s (OFF)	---	-1.065E+0	-1.447E+0	-1.733E+0	-1.949E+0

7. Icc

Ta= 25°C ; Vcc = 5V ; All bits on

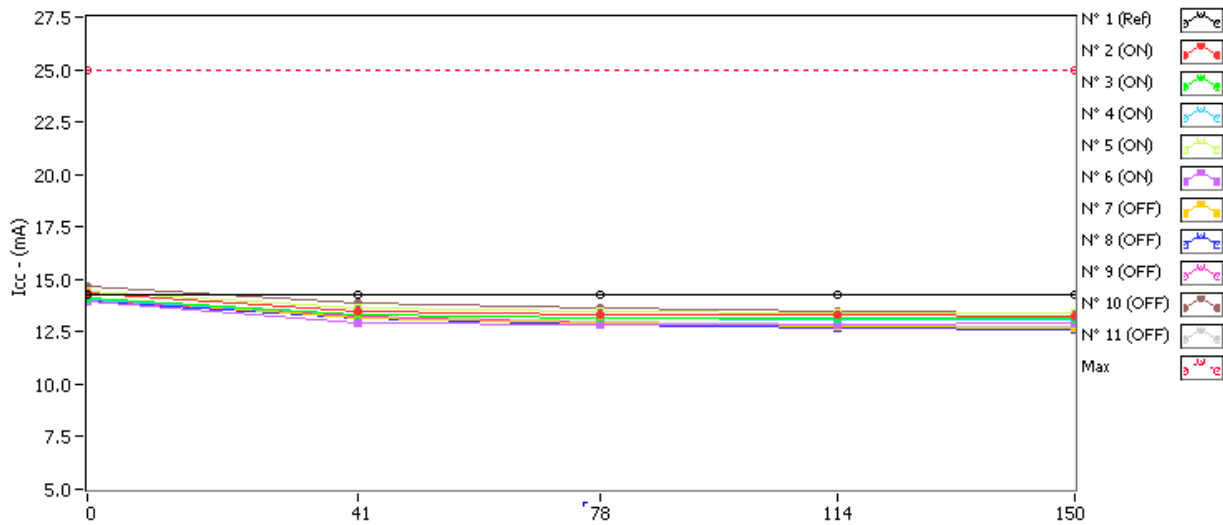

Icc . (mA) Max = 25.0

	0krad(Si)	41krad(Si)	78krad(Si)	114krad(Si)	150krad(Si)
N° 1 (Ref)	14.31	14.30	14.29	14.30	14.29
N° 2 (ON)	14.38	13.45	13.31	13.28	13.28
N° 3 (ON)	14.10	13.33	13.19	13.15	13.13
N° 4 (ON)	14.07	13.34	13.18	13.11	13.08
N° 5 (ON)	14.42	13.60	13.46	13.43	13.41
N° 6 (ON)	13.97	12.92	12.85	12.87	12.90
N° 7 (OFF)	14.12	13.17	12.89	12.75	12.65
N° 8 (OFF)	13.98	13.13	12.86	12.72	12.62
N° 9 (OFF)	14.03	13.20	12.94	12.80	12.69
N° 10 (OFF)	14.64	13.86	13.61	13.47	13.36
N° 11 (OFF)	14.06	13.25	12.99	12.85	12.74

Delta [Icc]

	0krad(Si)	41krad(Si)	78krad(Si)	114krad(Si)	150krad(Si)
N° 1 (Ref)	---	-6.850E-3	-1.457E-2	-8.610E-3	-1.564E-2
N° 2 (ON)	---	-9.342E-1	-1.076E+0	-1.099E+0	-1.104E+0
N° 3 (ON)	---	-7.648E-1	-9.085E-1	-9.490E-1	-9.674E-1
N° 4 (ON)	---	-7.295E-1	-8.925E-1	-9.544E-1	-9.862E-1
N° 5 (ON)	---	-8.223E-1	-9.576E-1	-9.923E-1	-1.007E+0
N° 6 (ON)	---	-1.047E+0	-1.117E+0	-1.096E+0	-1.066E+0
N° 7 (OFF)	---	-9.474E-1	-1.232E+0	-1.366E+0	-1.467E+0
N° 8 (OFF)	---	-8.470E-1	-1.117E+0	-1.255E+0	-1.355E+0
N° 9 (OFF)	---	-8.261E-1	-1.088E+0	-1.229E+0	-1.331E+0
N° 10 (OFF)	---	-7.742E-1	-1.029E+0	-1.171E+0	-1.273E+0
N° 11 (OFF)	---	-8.149E-1	-1.074E+0	-1.209E+0	-1.319E+0
Average (ON)	---	-8.597E-1	-9.903E-1	-1.018E+0	-1.026E+0
s (ON)	---	1.305E-1	1.008E-1	7.452E-2	5.732E-2
Average+3s (ON)	---	-4.681E-1	-6.878E-1	-7.947E-1	-8.543E-1
Average-3s (ON)	---	-1.251E+0	-1.293E+0	-1.242E+0	-1.198E+0
Average (OFF)	---	-8.419E-1	-1.108E+0	-1.246E+0	-1.349E+0
s (OFF)	---	6.468E-2	7.612E-2	7.396E-2	7.236E-2
Average+3s (OFF)	---	-6.479E-1	-8.797E-1	-1.024E+0	-1.132E+0
Average-3s (OFF)	---	-1.036E+0	-1.336E+0	-1.468E+0	-1.566E+0

8. Vih_DB0

Ta= 25°C ; Vcc = 5V

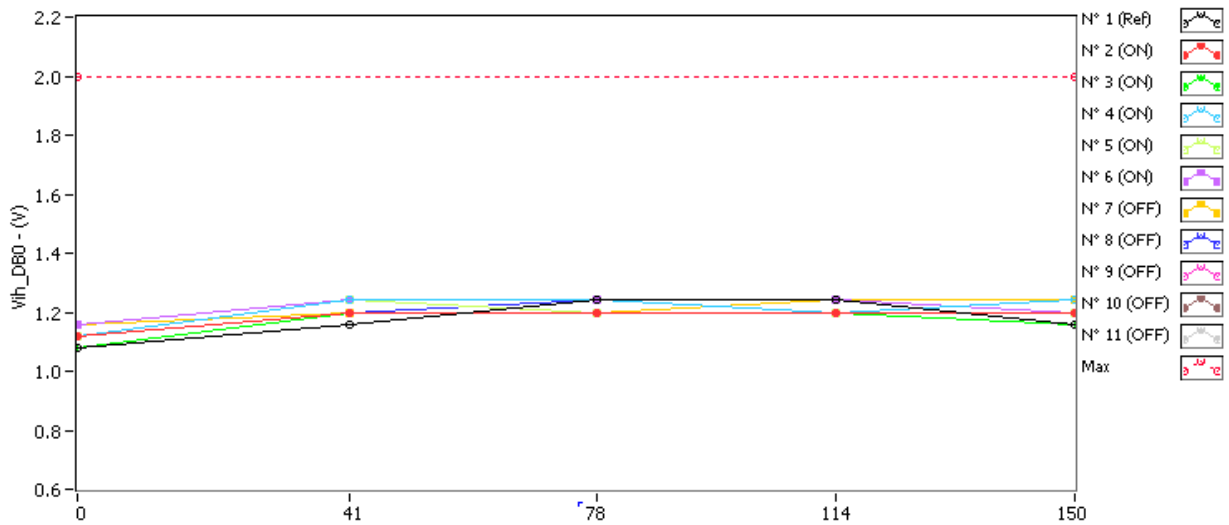

Vih_DB0 . (V) Max = 2.0

	0krad(Si)	41krad(Si)	78krad(Si)	114krad(Si)	150krad(Si)
N° 1 (Ref)	1.08	1.16	1.24	1.24	1.16
N° 2 (ON)	1.12	1.20	1.20	1.20	1.20
N° 3 (ON)	1.08	1.20	1.20	1.20	1.16
N° 4 (ON)	1.12	1.24	1.24	1.20	1.24
N° 5 (ON)	1.12	1.24	1.20	1.20	1.20
N° 6 (ON)	1.16	1.24	1.24	1.24	1.20
N° 7 (OFF)	1.16	1.20	1.20	1.24	1.24
N° 8 (OFF)	1.16	1.20	1.24	1.24	1.24
N° 9 (OFF)	1.16	1.20	1.20	1.24	1.24
N° 10 (OFF)	1.16	1.20	1.20	1.24	1.24
N° 11 (OFF)	1.16	1.20	1.20	1.20	1.20

Delta [Vih_DB0]

	0krad(Si)	41krad(Si)	78krad(Si)	114krad(Si)	150krad(Si)
N° 1 (Ref)	---	8.000E-2	1.600E-1	1.600E-1	8.000E-2
N° 2 (ON)	---	8.000E-2	8.000E-2	8.000E-2	8.000E-2
N° 3 (ON)	---	1.200E-1	1.200E-1	1.200E-1	8.000E-2
N° 4 (ON)	---	1.200E-1	1.200E-1	8.000E-2	1.200E-1
N° 5 (ON)	---	1.200E-1	8.000E-2	8.000E-2	8.000E-2
N° 6 (ON)	---	8.000E-2	8.000E-2	8.000E-2	4.000E-2
N° 7 (OFF)	---	4.000E-2	4.000E-2	8.000E-2	8.000E-2
N° 8 (OFF)	---	4.000E-2	8.000E-2	8.000E-2	8.000E-2
N° 9 (OFF)	---	4.000E-2	4.000E-2	8.000E-2	8.000E-2
N° 10 (OFF)	---	4.000E-2	4.000E-2	8.000E-2	8.000E-2
N° 11 (OFF)	---	4.000E-2	4.000E-2	4.000E-2	4.000E-2
Average (ON)	---	1.040E-1	9.600E-2	8.800E-2	8.000E-2
s (ON)	---	2.191E-2	2.191E-2	1.789E-2	2.828E-2
Average+3s (ON)	---	1.697E-1	1.617E-1	1.417E-1	1.649E-1
Average-3s (ON)	---	3.827E-2	3.027E-2	3.433E-2	-4.853E-3
Average (OFF)	---	4.000E-2	4.800E-2	7.200E-2	7.200E-2
s (OFF)	---	0.000E+0	1.789E-2	1.789E-2	1.789E-2
Average+3s (OFF)	---	4.000E-2	1.017E-1	1.257E-1	1.257E-1
Average-3s (OFF)	---	4.000E-2	-5.666E-3	1.833E-2	1.833E-2

9. Vih_DB1

Ta= 25°C ; Vcc = 5V

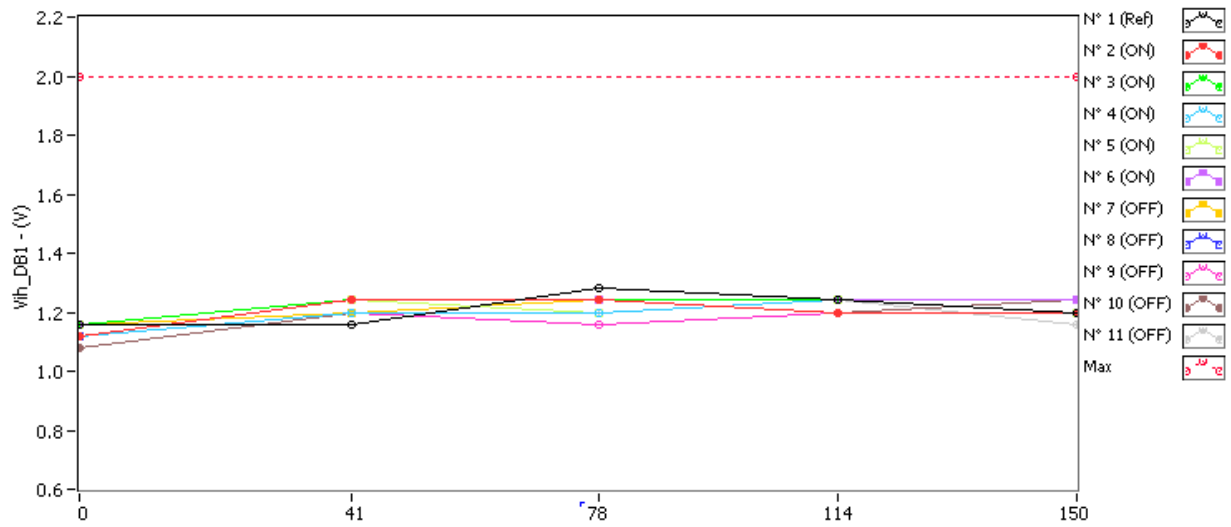

Vih_DB1 . (V) Max = 2.0

	0krad(Si)	41krad(Si)	78krad(Si)	114krad(Si)	150krad(Si)
N° 1 (Ref)	1.16	1.16	1.28	1.24	1.20
N° 2 (ON)	1.12	1.24	1.24	1.20	1.20
N° 3 (ON)	1.16	1.24	1.24	1.24	1.20
N° 4 (ON)	1.12	1.20	1.20	1.24	1.20
N° 5 (ON)	1.16	1.24	1.20	1.24	1.20
N° 6 (ON)	1.16	1.24	1.24	1.24	1.24
N° 7 (OFF)	1.16	1.20	1.24	1.24	1.24
N° 8 (OFF)	1.12	1.24	1.24	1.24	1.24
N° 9 (OFF)	1.12	1.20	1.16	1.20	1.20
N° 10 (OFF)	1.08	1.20	1.24	1.20	1.24
N° 11 (OFF)	1.16	1.24	1.20	1.24	1.16

Delta [Vih_DB1]

	0krad(Si)	41krad(Si)	78krad(Si)	114krad(Si)	150krad(Si)
N° 1 (Ref)	---	0.000E+0	1.200E-1	8.000E-2	4.000E-2
N° 2 (ON)	---	1.200E-1	1.200E-1	8.000E-2	8.000E-2
N° 3 (ON)	---	8.000E-2	8.000E-2	8.000E-2	4.000E-2
N° 4 (ON)	---	8.000E-2	8.000E-2	1.200E-1	8.000E-2
N° 5 (ON)	---	8.000E-2	4.000E-2	8.000E-2	4.000E-2
N° 6 (ON)	---	8.000E-2	8.000E-2	8.000E-2	8.000E-2
N° 7 (OFF)	---	4.000E-2	8.000E-2	8.000E-2	8.000E-2
N° 8 (OFF)	---	1.200E-1	1.200E-1	1.200E-1	1.200E-1
N° 9 (OFF)	---	8.000E-2	4.000E-2	8.000E-2	8.000E-2
N° 10 (OFF)	---	1.200E-1	1.600E-1	1.200E-1	1.600E-1
N° 11 (OFF)	---	8.000E-2	4.000E-2	8.000E-2	0.000E+0
Average (ON)	---	8.800E-2	8.000E-2	8.800E-2	6.400E-2
s (ON)	---	1.789E-2	2.828E-2	1.789E-2	2.191E-2
Average+3s (ON)	---	1.417E-1	1.649E-1	1.417E-1	1.297E-1
Average-3s (ON)	---	3.433E-2	-4.853E-3	3.433E-2	-1.727E-3
Average (OFF)	---	8.800E-2	8.800E-2	9.600E-2	8.800E-2
s (OFF)	---	3.347E-2	5.215E-2	2.191E-2	5.933E-2
Average+3s (OFF)	---	1.884E-1	2.445E-1	1.617E-1	2.660E-1
Average-3s (OFF)	---	-1.240E-2	-6.846E-2	3.027E-2	-8.999E-2

10. Vih_DB2

Ta= 25°C ; Vcc = 5V

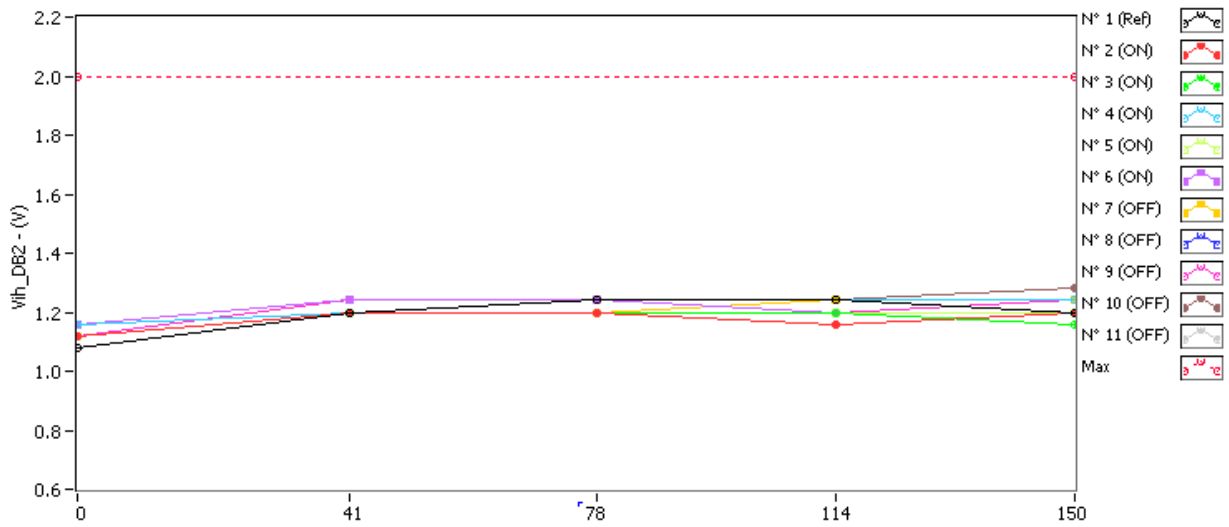

Vih_DB2 . (V) Max = 2.0

	0krad(Si)	41krad(Si)	78krad(Si)	114krad(Si)	150krad(Si)
N° 1 (Ref)	1.08	1.20	1.24	1.24	1.20
N° 2 (ON)	1.12	1.20	1.20	1.16	1.20
N° 3 (ON)	1.12	1.20	1.20	1.20	1.16
N° 4 (ON)	1.16	1.20	1.24	1.24	1.24
N° 5 (ON)	1.12	1.20	1.20	1.20	1.20
N° 6 (ON)	1.16	1.24	1.24	1.20	1.20
N° 7 (OFF)	1.16	1.20	1.20	1.24	1.24
N° 8 (OFF)	1.16	1.24	1.24	1.24	1.20
N° 9 (OFF)	1.12	1.24	1.24	1.20	1.24
N° 10 (OFF)	1.12	1.20	1.20	1.24	1.28
N° 11 (OFF)	1.12	1.20	1.20	1.20	1.20

Delta [Vih_DB2]

	0krad(Si)	41krad(Si)	78krad(Si)	114krad(Si)	150krad(Si)
N° 1 (Ref)	---	1.200E-1	1.600E-1	1.600E-1	1.200E-1
N° 2 (ON)	---	8.000E-2	8.000E-2	4.000E-2	8.000E-2
N° 3 (ON)	---	8.000E-2	8.000E-2	8.000E-2	4.000E-2
N° 4 (ON)	---	4.000E-2	8.000E-2	8.000E-2	8.000E-2
N° 5 (ON)	---	8.000E-2	8.000E-2	8.000E-2	8.000E-2
N° 6 (ON)	---	8.000E-2	8.000E-2	4.000E-2	4.000E-2
N° 7 (OFF)	---	4.000E-2	4.000E-2	8.000E-2	8.000E-2
N° 8 (OFF)	---	8.000E-2	8.000E-2	8.000E-2	4.000E-2
N° 9 (OFF)	---	1.200E-1	1.200E-1	8.000E-2	1.200E-1
N° 10 (OFF)	---	8.000E-2	8.000E-2	1.200E-1	1.600E-1
N° 11 (OFF)	---	8.000E-2	8.000E-2	8.000E-2	8.000E-2
Average (ON)	---	7.200E-2	8.000E-2	6.400E-2	6.400E-2
s (ON)	---	1.789E-2	1.218E-16	2.191E-2	2.191E-2
Average+3s (ON)	---	1.257E-1	8.000E-2	1.297E-1	1.297E-1
Average-3s (ON)	---	1.833E-2	8.000E-2	-1.727E-3	-1.727E-3
Average (OFF)	---	8.000E-2	8.000E-2	8.800E-2	9.600E-2
s (OFF)	---	2.828E-2	2.828E-2	1.789E-2	4.561E-2
Average+3s (OFF)	---	1.649E-1	1.649E-1	1.417E-1	2.328E-1
Average-3s (OFF)	---	-4.853E-3	-4.853E-3	3.433E-2	-4.082E-2

11. Vih_DB3

Ta= 25°C ; Vcc = 5V

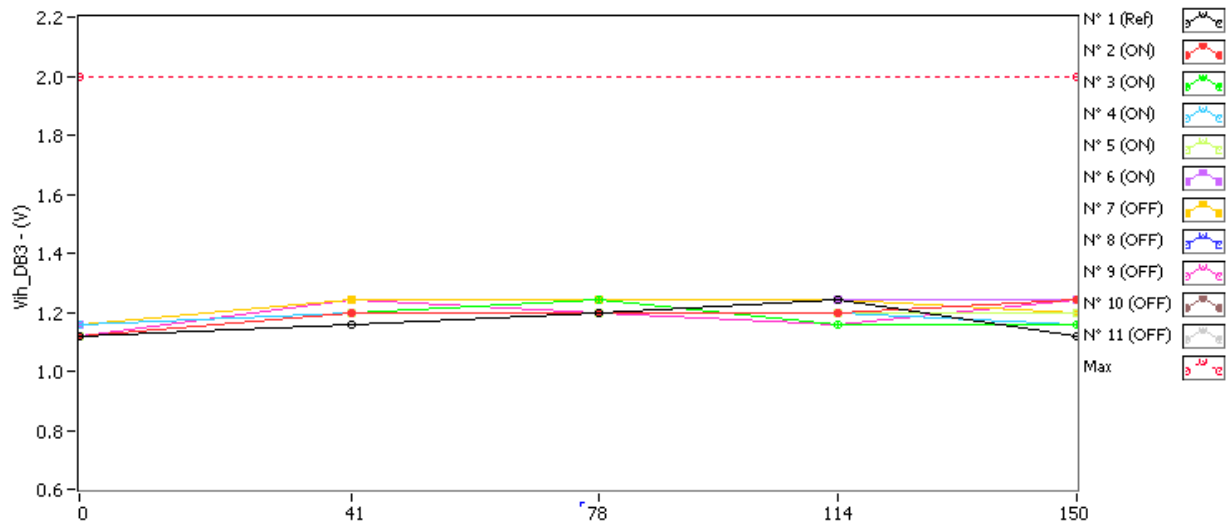

Vih_DB3 . (V) Max = 2.0

	0krad(Si)	41krad(Si)	78krad(Si)	114krad(Si)	150krad(Si)
N° 1 (Ref)	1.12	1.16	1.20	1.24	1.12
N° 2 (ON)	1.12	1.20	1.20	1.20	1.24
N° 3 (ON)	1.12	1.20	1.24	1.16	1.16
N° 4 (ON)	1.16	1.20	1.20	1.20	1.16
N° 5 (ON)	1.12	1.20	1.20	1.20	1.20
N° 6 (ON)	1.16	1.20	1.20	1.24	1.24
N° 7 (OFF)	1.16	1.24	1.24	1.24	1.20
N° 8 (OFF)	1.16	1.20	1.20	1.24	1.24
N° 9 (OFF)	1.12	1.24	1.20	1.16	1.24
N° 10 (OFF)	1.12	1.20	1.20	1.20	1.24
N° 11 (OFF)	1.16	1.20	1.20	1.20	1.16

Delta [Vih_DB3]

	0krad(Si)	41krad(Si)	78krad(Si)	114krad(Si)	150krad(Si)
N° 1 (Ref)	---	4.000E-2	8.000E-2	1.200E-1	0.000E+0
N° 2 (ON)	---	8.000E-2	8.000E-2	8.000E-2	1.200E-1
N° 3 (ON)	---	8.000E-2	1.200E-1	4.000E-2	4.000E-2
N° 4 (ON)	---	4.000E-2	4.000E-2	4.000E-2	0.000E+0
N° 5 (ON)	---	8.000E-2	8.000E-2	8.000E-2	8.000E-2
N° 6 (ON)	---	4.000E-2	4.000E-2	8.000E-2	8.000E-2
N° 7 (OFF)	---	8.000E-2	8.000E-2	8.000E-2	4.000E-2
N° 8 (OFF)	---	4.000E-2	4.000E-2	8.000E-2	8.000E-2
N° 9 (OFF)	---	1.200E-1	8.000E-2	4.000E-2	1.200E-1
N° 10 (OFF)	---	8.000E-2	8.000E-2	8.000E-2	1.200E-1
N° 11 (OFF)	---	4.000E-2	4.000E-2	4.000E-2	0.000E+0
Average (ON)	---	6.400E-2	7.200E-2	6.400E-2	6.400E-2
s (ON)	---	2.191E-2	3.347E-2	2.191E-2	4.561E-2
Average+3s (ON)	---	1.297E-1	1.724E-1	1.297E-1	2.008E-1
Average-3s (ON)	---	-1.727E-3	-2.840E-2	-1.727E-3	-7.282E-2
Average (OFF)	---	7.200E-2	6.400E-2	6.400E-2	7.200E-2
s (OFF)	---	3.347E-2	2.191E-2	2.191E-2	5.215E-2
Average+3s (OFF)	---	1.724E-1	1.297E-1	1.297E-1	2.285E-1
Average-3s (OFF)	---	-2.840E-2	-1.727E-3	-1.727E-3	-8.446E-2

12. Vih_DB4

Ta= 25°C ; Vcc = 5V

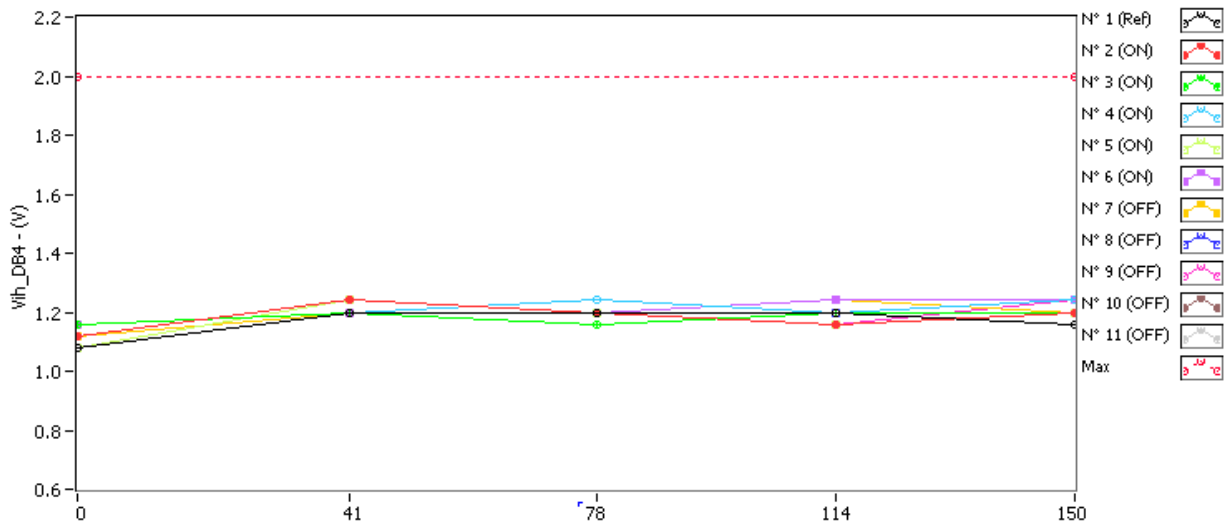

Vih_DB4 . (V) Max = 2.0

	0krad(Si)	41krad(Si)	78krad(Si)	114krad(Si)	150krad(Si)
N° 1 (Ref)	1.08	1.20	1.20	1.20	1.16
N° 2 (ON)	1.12	1.24	1.20	1.16	1.20
N° 3 (ON)	1.16	1.20	1.16	1.20	1.20
N° 4 (ON)	1.08	1.20	1.24	1.20	1.24
N° 5 (ON)	1.08	1.24	1.20	1.16	1.20
N° 6 (ON)	1.16	1.20	1.20	1.24	1.24
N° 7 (OFF)	1.12	1.20	1.20	1.24	1.20
N° 8 (OFF)	1.08	1.20	1.20	1.20	1.24
N° 9 (OFF)	1.08	1.20	1.20	1.16	1.24
N° 10 (OFF)	1.16	1.20	1.20	1.24	1.20
N° 11 (OFF)	1.12	1.20	1.16	1.20	1.20

Delta [Vih_DB4]

	0krad(Si)	41krad(Si)	78krad(Si)	114krad(Si)	150krad(Si)
N° 1 (Ref)	---	1.200E-1	1.200E-1	1.200E-1	8.000E-2
N° 2 (ON)	---	1.200E-1	8.000E-2	4.000E-2	8.000E-2
N° 3 (ON)	---	4.000E-2	0.000E+0	4.000E-2	4.000E-2
N° 4 (ON)	---	1.200E-1	1.600E-1	1.200E-1	1.600E-1
N° 5 (ON)	---	1.600E-1	1.200E-1	8.000E-2	1.200E-1
N° 6 (ON)	---	4.000E-2	4.000E-2	8.000E-2	8.000E-2
N° 7 (OFF)	---	8.000E-2	8.000E-2	1.200E-1	8.000E-2
N° 8 (OFF)	---	1.200E-1	1.200E-1	1.200E-1	1.600E-1
N° 9 (OFF)	---	1.200E-1	1.200E-1	8.000E-2	1.600E-1
N° 10 (OFF)	---	4.000E-2	4.000E-2	8.000E-2	4.000E-2
N° 11 (OFF)	---	8.000E-2	4.000E-2	8.000E-2	8.000E-2
Average (ON)	---	9.600E-2	8.000E-2	7.200E-2	9.600E-2
s (ON)	---	5.367E-2	6.325E-2	3.347E-2	4.561E-2
Average+3s (ON)	---	2.570E-1	2.697E-1	1.724E-1	2.328E-1
Average-3s (ON)	---	-6.500E-2	-1.097E-1	-2.840E-2	-4.082E-2
Average (OFF)	---	8.800E-2	8.000E-2	9.600E-2	1.040E-1
s (OFF)	---	3.347E-2	4.000E-2	2.191E-2	5.367E-2
Average+3s (OFF)	---	1.884E-1	2.000E-1	1.617E-1	2.650E-1
Average-3s (OFF)	---	-1.240E-2	-4.000E-2	3.027E-2	-5.700E-2

13. Vih_DB5

Ta= 25°C ; Vcc = 5V

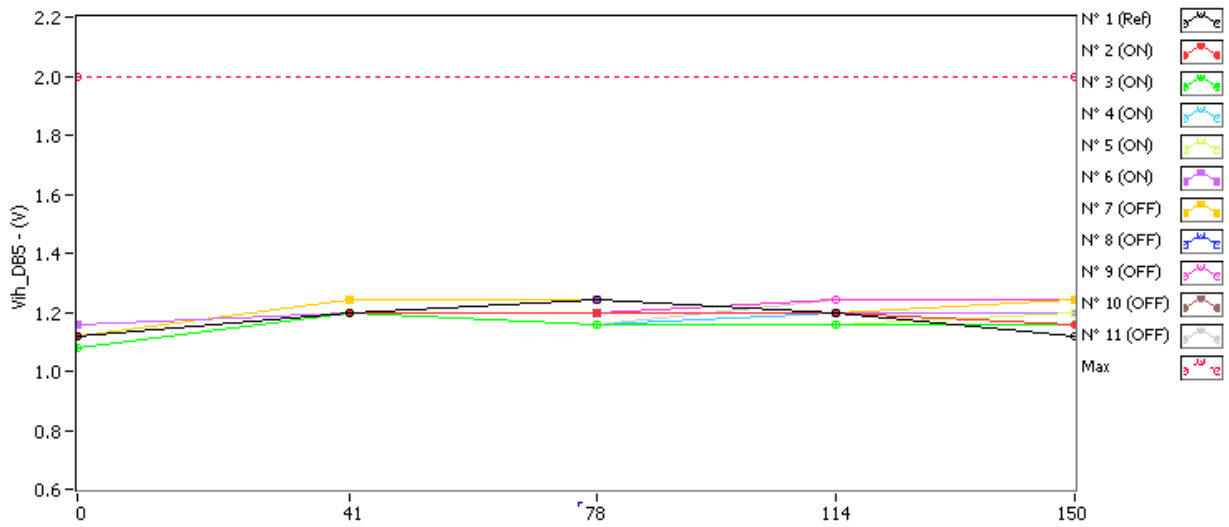

Vih_DB5 . (V) Max = 2.0

	0krad(Si)	41krad(Si)	78krad(Si)	114krad(Si)	150krad(Si)
N° 1 (Ref)	1.12	1.20	1.24	1.20	1.12
N° 2 (ON)	1.12	1.20	1.20	1.20	1.16
N° 3 (ON)	1.08	1.20	1.16	1.16	1.16
N° 4 (ON)	1.12	1.20	1.16	1.20	1.16
N° 5 (ON)	1.12	1.20	1.16	1.16	1.20
N° 6 (ON)	1.16	1.20	1.24	1.20	1.20
N° 7 (OFF)	1.12	1.24	1.24	1.20	1.24
N° 8 (OFF)	1.12	1.20	1.20	1.20	1.20
N° 9 (OFF)	1.12	1.20	1.20	1.24	1.24
N° 10 (OFF)	1.12	1.20	1.20	1.20	1.20
N° 11 (OFF)	1.12	1.20	1.16	1.24	1.24

Delta [Vih_DB5]

	0krad(Si)	41krad(Si)	78krad(Si)	114krad(Si)	150krad(Si)
N° 1 (Ref)	---	8.000E-2	1.200E-1	8.000E-2	0.000E+0
N° 2 (ON)	---	8.000E-2	8.000E-2	8.000E-2	4.000E-2
N° 3 (ON)	---	1.200E-1	8.000E-2	8.000E-2	8.000E-2
N° 4 (ON)	---	8.000E-2	4.000E-2	8.000E-2	4.000E-2
N° 5 (ON)	---	8.000E-2	4.000E-2	4.000E-2	8.000E-2
N° 6 (ON)	---	4.000E-2	8.000E-2	4.000E-2	4.000E-2
N° 7 (OFF)	---	1.200E-1	1.200E-1	8.000E-2	1.200E-1
N° 8 (OFF)	---	8.000E-2	8.000E-2	8.000E-2	8.000E-2
N° 9 (OFF)	---	8.000E-2	8.000E-2	1.200E-1	1.200E-1
N° 10 (OFF)	---	8.000E-2	8.000E-2	8.000E-2	8.000E-2
N° 11 (OFF)	---	8.000E-2	4.000E-2	1.200E-1	1.200E-1
Average (ON)	---	8.000E-2	6.400E-2	6.400E-2	5.600E-2
s (ON)	---	2.828E-2	2.191E-2	2.191E-2	2.191E-2
Average+3s (ON)	---	1.649E-1	1.297E-1	1.297E-1	1.217E-1
Average-3s (ON)	---	-4.853E-3	-1.727E-3	-1.727E-3	-9.727E-3
Average (OFF)	---	8.800E-2	8.000E-2	9.600E-2	1.040E-1
s (OFF)	---	1.789E-2	2.828E-2	2.191E-2	2.191E-2
Average+3s (OFF)	---	1.417E-1	1.649E-1	1.617E-1	1.697E-1
Average-3s (OFF)	---	3.433E-2	-4.853E-3	3.027E-2	3.827E-2

14. Vih_DB6

Ta= 25°C ; Vcc = 5V

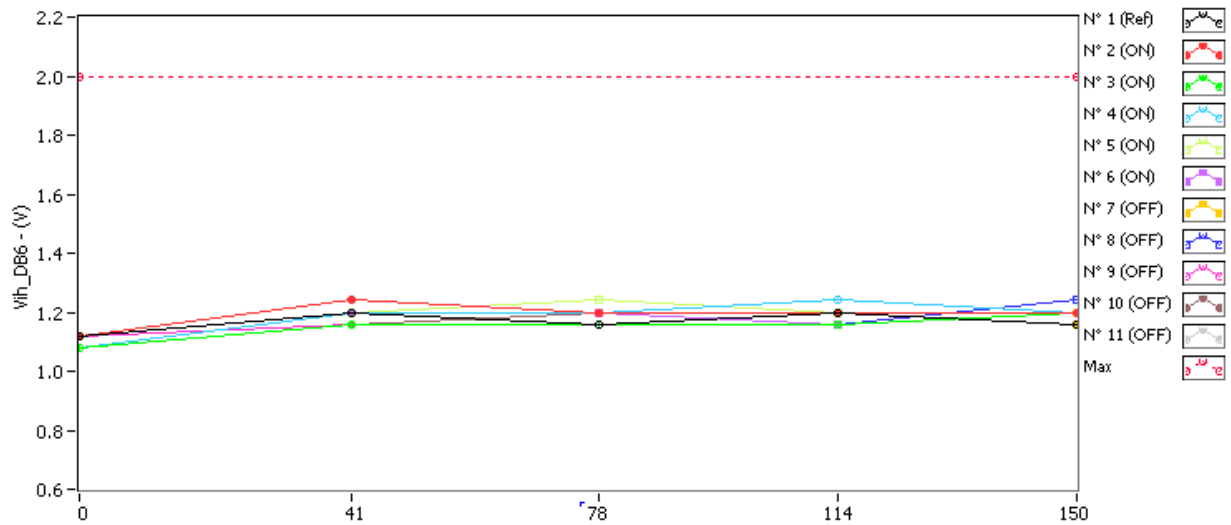

Vih_DB6 . (V) Max = 2.0

	0krad(Si)	41krad(Si)	78krad(Si)	114krad(Si)	150krad(Si)
N° 1 (Ref)	1.12	1.20	1.16	1.20	1.16
N° 2 (ON)	1.12	1.24	1.20	1.20	1.20
N° 3 (ON)	1.08	1.16	1.16	1.16	1.20
N° 4 (ON)	1.08	1.20	1.20	1.24	1.20
N° 5 (ON)	1.12	1.20	1.24	1.20	1.20
N° 6 (ON)	1.12	1.20	1.20	1.16	1.20
N° 7 (OFF)	1.12	1.20	1.20	1.20	1.16
N° 8 (OFF)	1.12	1.20	1.20	1.16	1.24
N° 9 (OFF)	1.12	1.16	1.16	1.16	1.20
N° 10 (OFF)	1.12	1.16	1.20	1.20	1.20
N° 11 (OFF)	1.08	1.16	1.20	1.24	1.20

Delta [Vih_DB6]

	0krad(Si)	41krad(Si)	78krad(Si)	114krad(Si)	150krad(Si)
N° 1 (Ref)	---	8.000E-2	4.000E-2	8.000E-2	4.000E-2
N° 2 (ON)	---	1.200E-1	8.000E-2	8.000E-2	8.000E-2
N° 3 (ON)	---	8.000E-2	8.000E-2	8.000E-2	1.200E-1
N° 4 (ON)	---	1.200E-1	1.200E-1	1.600E-1	1.200E-1
N° 5 (ON)	---	8.000E-2	1.200E-1	8.000E-2	8.000E-2
N° 6 (ON)	---	8.000E-2	8.000E-2	4.000E-2	8.000E-2
N° 7 (OFF)	---	8.000E-2	8.000E-2	8.000E-2	4.000E-2
N° 8 (OFF)	---	8.000E-2	8.000E-2	4.000E-2	1.200E-1
N° 9 (OFF)	---	4.000E-2	4.000E-2	4.000E-2	8.000E-2
N° 10 (OFF)	---	4.000E-2	8.000E-2	8.000E-2	8.000E-2
N° 11 (OFF)	---	8.000E-2	1.200E-1	1.600E-1	1.200E-1
Average (ON)	---	9.600E-2	9.600E-2	8.800E-2	9.600E-2
s (ON)	---	2.191E-2	2.191E-2	4.382E-2	2.191E-2
Average+3s (ON)	---	1.617E-1	1.617E-1	2.195E-1	1.617E-1
Average-3s (ON)	---	3.027E-2	3.027E-2	-4.345E-2	3.027E-2
Average (OFF)	---	6.400E-2	8.000E-2	8.000E-2	8.800E-2
s (OFF)	---	2.191E-2	2.828E-2	4.899E-2	3.347E-2
Average+3s (OFF)	---	1.297E-1	1.649E-1	2.270E-1	1.884E-1
Average-3s (OFF)	---	-1.727E-3	-4.853E-3	-6.697E-2	-1.240E-2

15. Vih_DB7

Ta= 25°C ; Vcc = 5V

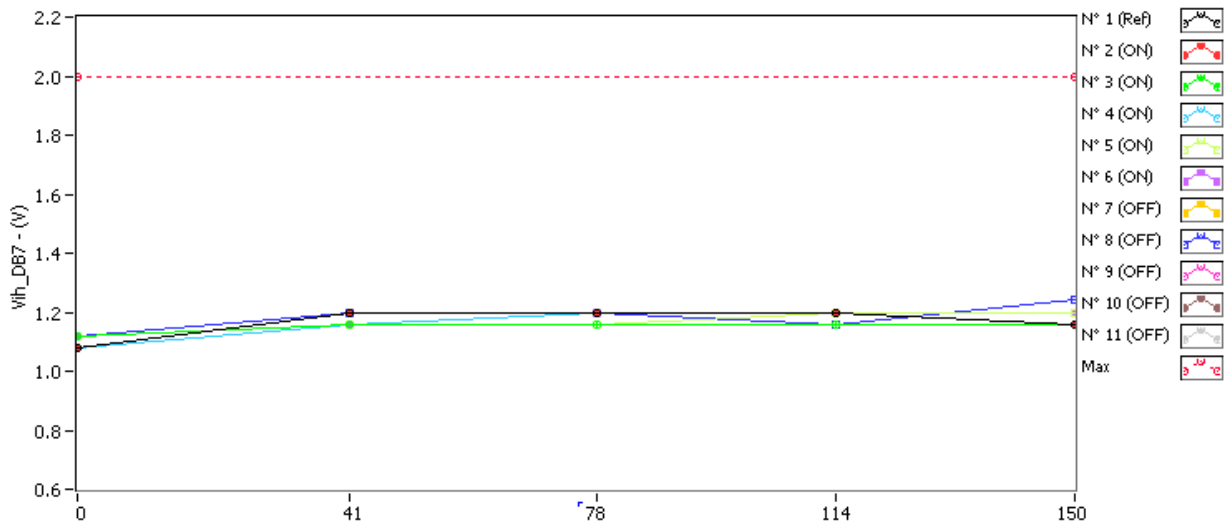

Vih_DB7 . (V) Max = 2.0

	0krad(Si)	41krad(Si)	78krad(Si)	114krad(Si)	150krad(Si)
N° 1 (Ref)	1.08	1.20	1.20	1.20	1.16
N° 2 (ON)	1.08	1.20	1.20	1.20	1.16
N° 3 (ON)	1.12	1.16	1.16	1.16	1.16
N° 4 (ON)	1.08	1.16	1.20	1.20	1.16
N° 5 (ON)	1.12	1.16	1.16	1.20	1.20
N° 6 (ON)	1.12	1.16	1.20	1.20	1.20
N° 7 (OFF)	1.12	1.16	1.20	1.20	1.20
N° 8 (OFF)	1.12	1.20	1.20	1.16	1.24
N° 9 (OFF)	1.08	1.20	1.20	1.20	1.20
N° 10 (OFF)	1.12	1.16	1.20	1.20	1.20
N° 11 (OFF)	1.08	1.16	1.20	1.20	1.16

Delta [Vih_DB7]

	0krad(Si)	41krad(Si)	78krad(Si)	114krad(Si)	150krad(Si)
N° 1 (Ref)	---	1.200E-1	1.200E-1	1.200E-1	8.000E-2
N° 2 (ON)	---	1.200E-1	1.200E-1	1.200E-1	8.000E-2
N° 3 (ON)	---	4.000E-2	4.000E-2	4.000E-2	4.000E-2
N° 4 (ON)	---	8.000E-2	1.200E-1	1.200E-1	8.000E-2
N° 5 (ON)	---	4.000E-2	4.000E-2	8.000E-2	8.000E-2
N° 6 (ON)	---	4.000E-2	8.000E-2	8.000E-2	8.000E-2
N° 7 (OFF)	---	4.000E-2	8.000E-2	8.000E-2	8.000E-2
N° 8 (OFF)	---	8.000E-2	8.000E-2	4.000E-2	1.200E-1
N° 9 (OFF)	---	1.200E-1	1.200E-1	1.200E-1	1.200E-1
N° 10 (OFF)	---	4.000E-2	8.000E-2	8.000E-2	8.000E-2
N° 11 (OFF)	---	8.000E-2	1.200E-1	1.200E-1	8.000E-2
Average (ON)	---	6.400E-2	8.000E-2	8.800E-2	7.200E-2
s (ON)	---	3.578E-2	4.000E-2	3.347E-2	1.789E-2
Average+3s (ON)	---	1.713E-1	2.000E-1	1.884E-1	1.257E-1
Average-3s (ON)	---	-4.333E-2	-4.000E-2	-1.240E-2	1.833E-2
Average (OFF)	---	7.200E-2	9.600E-2	8.800E-2	9.600E-2
s (OFF)	---	3.347E-2	2.191E-2	3.347E-2	2.191E-2
Average+3s (OFF)	---	1.724E-1	1.617E-1	1.884E-1	1.617E-1
Average-3s (OFF)	---	-2.840E-2	3.027E-2	-1.240E-2	3.027E-2

16. Vih_CS

Ta= 25°C ; Vcc = 5V

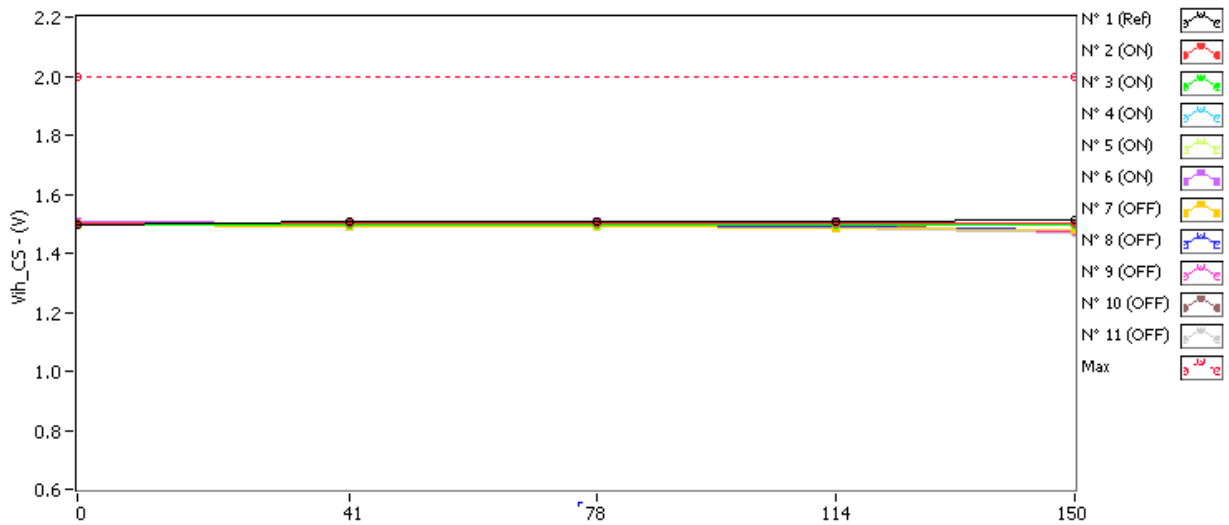

Vih_CS . (V) Max = 2.0

	0krad(Si)	41krad(Si)	78krad(Si)	114krad(Si)	150krad(Si)
N° 1 (Ref)	1.497	1.505	1.508	1.506	1.511
N° 2 (ON)	1.501	1.503	1.502	1.500	1.503
N° 3 (ON)	1.495	1.493	1.496	1.494	1.496
N° 4 (ON)	1.496	1.496	1.498	1.497	1.497
N° 5 (ON)	1.499	1.497	1.498	1.500	1.498
N° 6 (ON)	1.505	1.502	1.505	1.506	1.503
N° 7 (OFF)	1.494	1.490	1.489	1.486	1.479
N° 8 (OFF)	1.507	1.492	1.491	1.488	1.477
N° 9 (OFF)	1.505	1.492	1.491	1.489	1.475
N° 10 (OFF)	1.509	1.498	1.497	1.495	1.473
N° 11 (OFF)	1.501	1.489	1.488	1.486	1.467

Delta [Vih_CS]

	0krad(Si)	41krad(Si)	78krad(Si)	114krad(Si)	150krad(Si)
N° 1 (Ref)	---	8.000E-3	1.100E-2	9.000E-3	1.400E-2
N° 2 (ON)	---	2.000E-3	1.000E-3	-1.000E-3	2.000E-3
N° 3 (ON)	---	-2.000E-3	1.000E-3	-1.000E-3	1.000E-3
N° 4 (ON)	---	0.000E+0	2.000E-3	1.000E-3	1.000E-3
N° 5 (ON)	---	-2.000E-3	-1.000E-3	1.000E-3	-1.000E-3
N° 6 (ON)	---	-3.000E-3	0.000E+0	1.000E-3	-2.000E-3
N° 7 (OFF)	---	-4.000E-3	-5.000E-3	-8.000E-3	-1.500E-2
N° 8 (OFF)	---	-1.500E-2	-1.600E-2	-1.900E-2	-3.000E-2
N° 9 (OFF)	---	-1.300E-2	-1.400E-2	-1.600E-2	-3.000E-2
N° 10 (OFF)	---	-1.100E-2	-1.200E-2	-1.400E-2	-3.600E-2
N° 11 (OFF)	---	-1.200E-2	-1.300E-2	-1.500E-2	-3.400E-2
Average (ON)	---	-1.000E-3	6.000E-4	2.000E-4	2.000E-4
s (ON)	---	2.000E-3	1.140E-3	1.095E-3	1.643E-3
Average+3s (ON)	---	5.000E-3	4.021E-3	3.486E-3	5.130E-3
Average-3s (ON)	---	-7.000E-3	-2.821E-3	-3.086E-3	-4.730E-3
Average (OFF)	---	-1.100E-2	-1.200E-2	-1.440E-2	-2.900E-2
s (OFF)	---	4.183E-3	4.183E-3	4.037E-3	8.246E-3
Average+3s (OFF)	---	1.550E-3	5.499E-4	-2.288E-3	-4.261E-3
Average-3s (OFF)	---	-2.355E-2	-2.455E-2	-2.651E-2	-5.374E-2

17. Vih_CE

Ta= 25°C ; Vcc = 5V

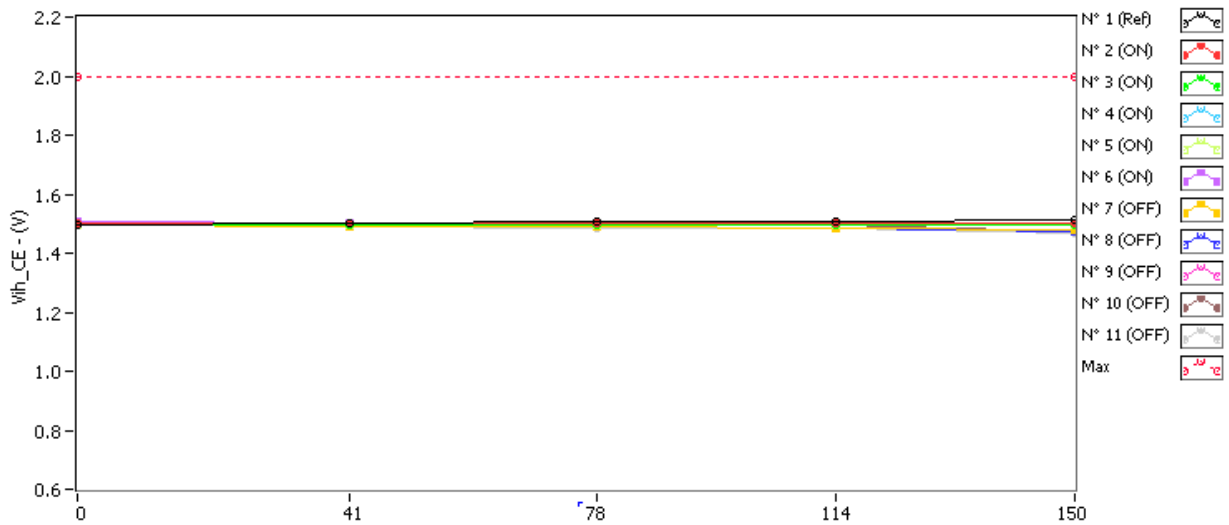

Vih_CE . (V) Max = 2.0

	0krad(Si)	41krad(Si)	78krad(Si)	114krad(Si)	150krad(Si)
N° 1 (Ref)	1.496	1.504	1.507	1.505	1.510
N° 2 (ON)	1.501	1.501	1.502	1.501	1.504
N° 3 (ON)	1.494	1.493	1.494	1.493	1.494
N° 4 (ON)	1.495	1.495	1.497	1.496	1.496
N° 5 (ON)	1.498	1.497	1.498	1.498	1.497
N° 6 (ON)	1.505	1.501	1.504	1.504	1.502
N° 7 (OFF)	1.494	1.489	1.488	1.486	1.477
N° 8 (OFF)	1.506	1.491	1.490	1.487	1.475
N° 9 (OFF)	1.504	1.490	1.489	1.487	1.472
N° 10 (OFF)	1.509	1.497	1.497	1.495	1.473
N° 11 (OFF)	1.501	1.488	1.487	1.485	1.466

Delta [Vih_CE]

	0krad(Si)	41krad(Si)	78krad(Si)	114krad(Si)	150krad(Si)
N° 1 (Ref)	---	8.000E-3	1.100E-2	9.000E-3	1.400E-2
N° 2 (ON)	---	0.000E+0	1.000E-3	0.000E+0	3.000E-3
N° 3 (ON)	---	-1.000E-3	0.000E+0	-1.000E-3	0.000E+0
N° 4 (ON)	---	0.000E+0	2.000E-3	1.000E-3	1.000E-3
N° 5 (ON)	---	-1.000E-3	0.000E+0	0.000E+0	-1.000E-3
N° 6 (ON)	---	-4.000E-3	-1.000E-3	-1.000E-3	-3.000E-3
N° 7 (OFF)	---	-5.000E-3	-6.000E-3	-8.000E-3	-1.700E-2
N° 8 (OFF)	---	-1.500E-2	-1.600E-2	-1.900E-2	-3.100E-2
N° 9 (OFF)	---	-1.400E-2	-1.500E-2	-1.700E-2	-3.200E-2
N° 10 (OFF)	---	-1.200E-2	-1.200E-2	-1.400E-2	-3.600E-2
N° 11 (OFF)	---	-1.300E-2	-1.400E-2	-1.600E-2	-3.500E-2
Average (ON)	---	-1.200E-3	4.000E-4	-2.000E-4	4.441E-17
s (ON)	---	1.643E-3	1.140E-3	8.367E-4	2.236E-3
Average+3s (ON)	---	3.730E-3	3.821E-3	2.310E-3	6.708E-3
Average-3s (ON)	---	-6.130E-3	-3.021E-3	-2.710E-3	-6.708E-3
Average (OFF)	---	-1.180E-2	-1.260E-2	-1.480E-2	-3.020E-2
s (OFF)	---	3.962E-3	3.975E-3	4.207E-3	7.662E-3
Average+3s (OFF)	---	8.697E-5	-6.752E-4	-2.179E-3	-7.215E-3
Average-3s (OFF)	---	-2.369E-2	-2.452E-2	-2.742E-2	-5.318E-2

18. Vil_DBO

Ta= 25°C ; Vcc = 5V

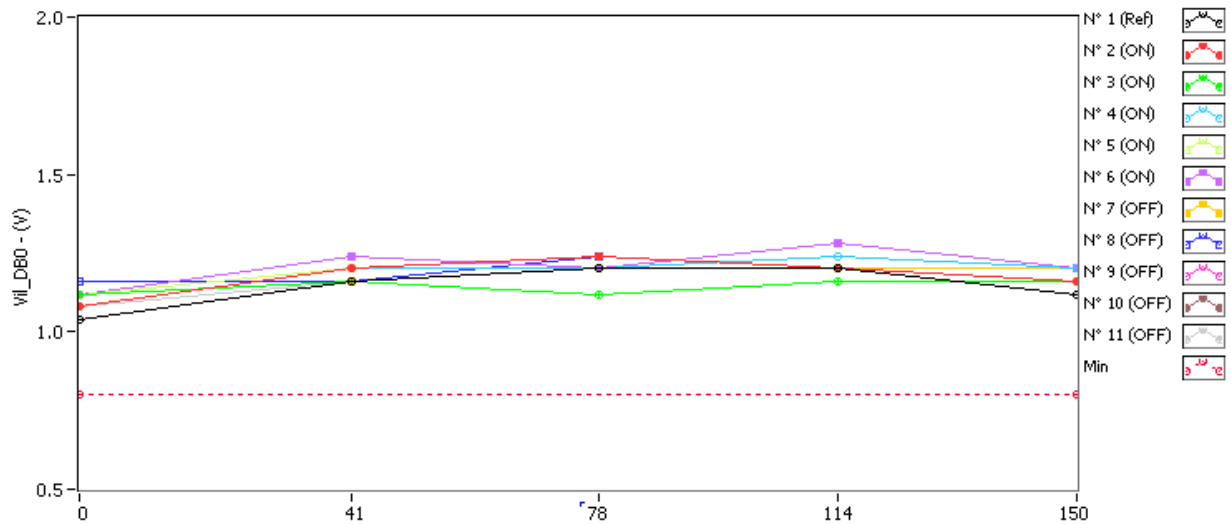

Vil_DBO . (V) Min = 0.8

	0krad(Si)	41krad(Si)	78krad(Si)	114krad(Si)	150krad(Si)
N° 1 (Ref)	1.04	1.16	1.20	1.20	1.12
N° 2 (ON)	1.08	1.20	1.24	1.20	1.16
N° 3 (ON)	1.12	1.16	1.12	1.16	1.16
N° 4 (ON)	1.08	1.20	1.20	1.24	1.20
N° 5 (ON)	1.12	1.20	1.20	1.20	1.16
N° 6 (ON)	1.12	1.24	1.20	1.28	1.20
N° 7 (OFF)	1.12	1.16	1.20	1.20	1.20
N° 8 (OFF)	1.16	1.16	1.24	1.20	1.20
N° 9 (OFF)	1.08	1.20	1.20	1.20	1.20
N° 10 (OFF)	1.12	1.20	1.24	1.20	1.20
N° 11 (OFF)	1.08	1.16	1.20	1.20	1.20

Delta [Vil_DBO]

	0krad(Si)	41krad(Si)	78krad(Si)	114krad(Si)	150krad(Si)
N° 1 (Ref)	---	1.200E-1	1.600E-1	1.600E-1	8.000E-2
N° 2 (ON)	---	1.200E-1	1.600E-1	1.200E-1	8.000E-2
N° 3 (ON)	---	4.000E-2	0.000E+0	4.000E-2	4.000E-2
N° 4 (ON)	---	1.200E-1	1.200E-1	1.600E-1	1.200E-1
N° 5 (ON)	---	8.000E-2	8.000E-2	8.000E-2	4.000E-2
N° 6 (ON)	---	1.200E-1	8.000E-2	1.600E-1	8.000E-2
N° 7 (OFF)	---	4.000E-2	8.000E-2	8.000E-2	8.000E-2
N° 8 (OFF)	---	0.000E+0	8.000E-2	4.000E-2	4.000E-2
N° 9 (OFF)	---	1.200E-1	1.200E-1	1.200E-1	1.200E-1
N° 10 (OFF)	---	8.000E-2	1.200E-1	8.000E-2	8.000E-2
N° 11 (OFF)	---	8.000E-2	1.200E-1	1.200E-1	1.200E-1
Average (ON)	---	9.600E-2	8.800E-2	1.120E-1	7.200E-2
s (ON)	---	3.578E-2	5.933E-2	5.215E-2	3.347E-2
Average+3s (ON)	---	2.033E-1	2.660E-1	2.685E-1	1.724E-1
Average-3s (ON)	---	-1.133E-2	-8.999E-2	-4.446E-2	-2.840E-2
Average (OFF)	---	6.400E-2	1.040E-1	8.800E-2	8.800E-2
s (OFF)	---	4.561E-2	2.191E-2	3.347E-2	3.347E-2
Average+3s (OFF)	---	2.008E-1	1.697E-1	1.884E-1	1.884E-1
Average-3s (OFF)	---	-7.282E-2	3.827E-2	-1.240E-2	-1.240E-2

19. Vil_DB1

Ta= 25°C ; Vcc = 5V

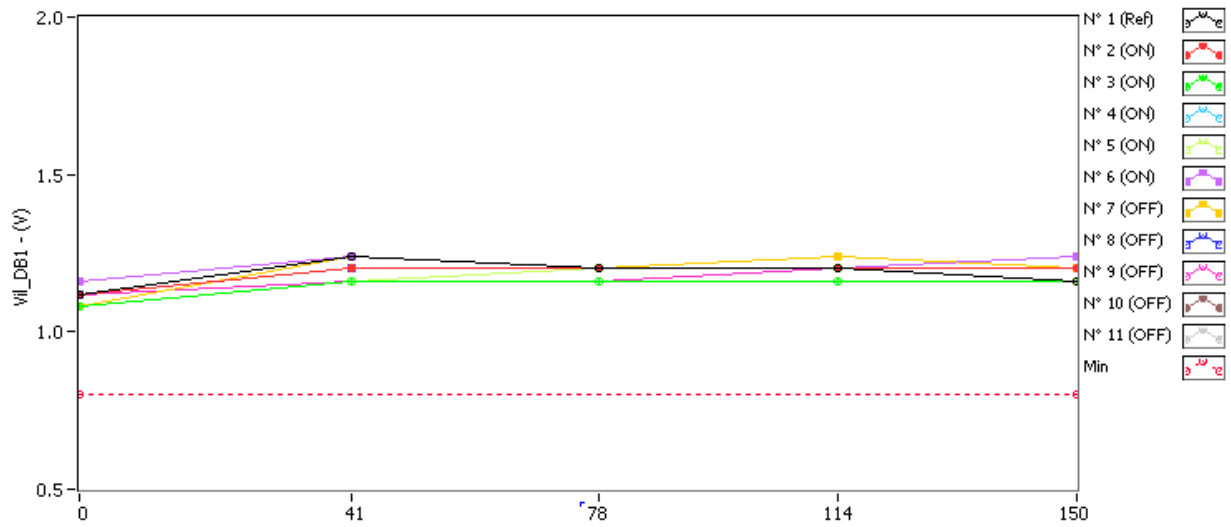

Vil_DB1 . (V) Min = 0.8

	0krad(Si)	41krad(Si)	78krad(Si)	114krad(Si)	150krad(Si)
N° 1 (Ref)	1.12	1.24	1.20	1.20	1.16
N° 2 (ON)	1.12	1.20	1.20	1.20	1.20
N° 3 (ON)	1.08	1.16	1.16	1.16	1.16
N° 4 (ON)	1.12	1.20	1.20	1.20	1.20
N° 5 (ON)	1.08	1.16	1.20	1.20	1.16
N° 6 (ON)	1.16	1.24	1.20	1.20	1.24
N° 7 (OFF)	1.08	1.24	1.20	1.24	1.20
N° 8 (OFF)	1.12	1.20	1.20	1.24	1.20
N° 9 (OFF)	1.12	1.16	1.16	1.20	1.20
N° 10 (OFF)	1.12	1.20	1.20	1.20	1.20
N° 11 (OFF)	1.12	1.20	1.20	1.20	1.20

Delta [Vil_DB1]

	0krad(Si)	41krad(Si)	78krad(Si)	114krad(Si)	150krad(Si)
N° 1 (Ref)	---	1.200E-1	8.000E-2	8.000E-2	4.000E-2
N° 2 (ON)	---	8.000E-2	8.000E-2	8.000E-2	8.000E-2
N° 3 (ON)	---	8.000E-2	8.000E-2	8.000E-2	8.000E-2
N° 4 (ON)	---	8.000E-2	8.000E-2	8.000E-2	8.000E-2
N° 5 (ON)	---	8.000E-2	1.200E-1	1.200E-1	8.000E-2
N° 6 (ON)	---	8.000E-2	4.000E-2	4.000E-2	8.000E-2
N° 7 (OFF)	---	1.600E-1	1.200E-1	1.600E-1	1.200E-1
N° 8 (OFF)	---	8.000E-2	8.000E-2	1.200E-1	8.000E-2
N° 9 (OFF)	---	4.000E-2	4.000E-2	8.000E-2	8.000E-2
N° 10 (OFF)	---	8.000E-2	8.000E-2	8.000E-2	8.000E-2
N° 11 (OFF)	---	8.000E-2	8.000E-2	8.000E-2	8.000E-2
Average (ON)	---	8.000E-2	8.000E-2	8.000E-2	8.000E-2
s (ON)	---	9.935E-17	2.828E-2	2.828E-2	9.935E-17
Average+3s (ON)	---	8.000E-2	1.649E-1	1.649E-1	8.000E-2
Average-3s (ON)	---	8.000E-2	-4.853E-3	-4.853E-3	8.000E-2
Average (OFF)	---	8.800E-2	8.000E-2	1.040E-1	8.800E-2
s (OFF)	---	4.382E-2	2.828E-2	3.578E-2	1.789E-2
Average+3s (OFF)	---	2.195E-1	1.649E-1	2.113E-1	1.417E-1
Average-3s (OFF)	---	-4.345E-2	-4.853E-3	-3.331E-3	3.433E-2

20. Vil_DB2

Ta= 25°C ; Vcc = 5V

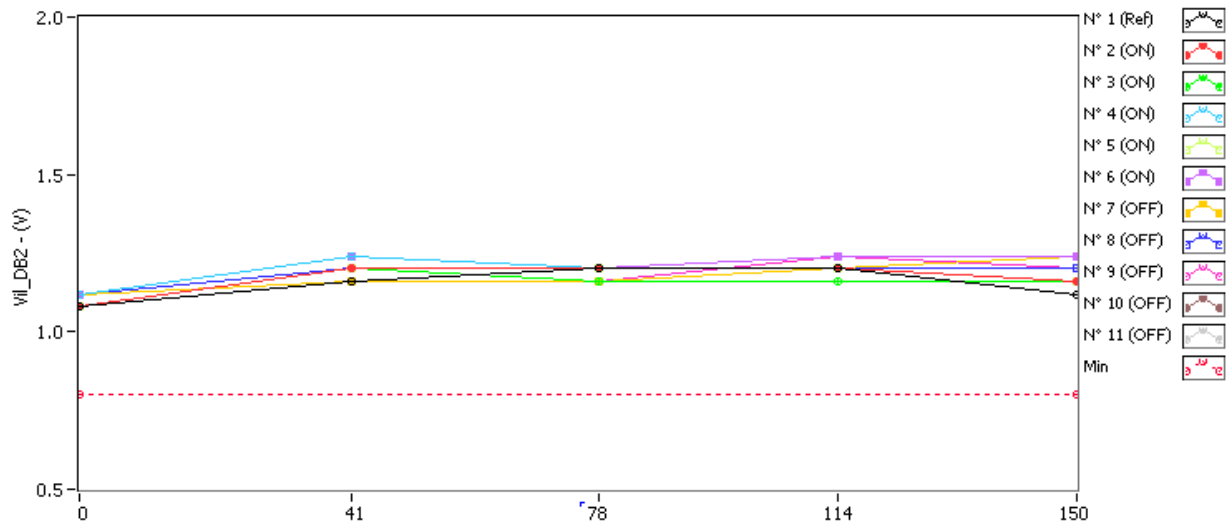

Vil_DB2 . (V) Min = 0.8

	0krad(Si)	41krad(Si)	78krad(Si)	114krad(Si)	150krad(Si)
N° 1 (Ref)	1.08	1.16	1.20	1.20	1.12
N° 2 (ON)	1.08	1.20	1.20	1.20	1.16
N° 3 (ON)	1.08	1.20	1.16	1.16	1.16
N° 4 (ON)	1.12	1.24	1.20	1.20	1.16
N° 5 (ON)	1.08	1.20	1.20	1.20	1.16
N° 6 (ON)	1.12	1.24	1.20	1.24	1.24
N° 7 (OFF)	1.12	1.16	1.16	1.20	1.24
N° 8 (OFF)	1.12	1.20	1.20	1.20	1.20
N° 9 (OFF)	1.08	1.16	1.16	1.24	1.20
N° 10 (OFF)	1.12	1.20	1.20	1.20	1.24
N° 11 (OFF)	1.12	1.16	1.20	1.20	1.20

Delta [Vil_DB2]

	0krad(Si)	41krad(Si)	78krad(Si)	114krad(Si)	150krad(Si)
N° 1 (Ref)	---	8.000E-2	1.200E-1	1.200E-1	4.000E-2
N° 2 (ON)	---	1.200E-1	1.200E-1	1.200E-1	8.000E-2
N° 3 (ON)	---	1.200E-1	8.000E-2	8.000E-2	8.000E-2
N° 4 (ON)	---	1.200E-1	8.000E-2	8.000E-2	4.000E-2
N° 5 (ON)	---	1.200E-1	1.200E-1	1.200E-1	8.000E-2
N° 6 (ON)	---	1.200E-1	8.000E-2	1.200E-1	1.200E-1
N° 7 (OFF)	---	4.000E-2	4.000E-2	8.000E-2	1.200E-1
N° 8 (OFF)	---	8.000E-2	8.000E-2	8.000E-2	8.000E-2
N° 9 (OFF)	---	8.000E-2	8.000E-2	1.600E-1	1.200E-1
N° 10 (OFF)	---	8.000E-2	8.000E-2	8.000E-2	1.200E-1
N° 11 (OFF)	---	4.000E-2	8.000E-2	8.000E-2	8.000E-2
Average (ON)	---	1.200E-1	9.600E-2	1.040E-1	8.000E-2
s (ON)	---	0.000E+0	2.191E-2	2.191E-2	2.828E-2
Average+3s (ON)	---	1.200E-1	1.617E-1	1.697E-1	1.649E-1
Average-3s (ON)	---	1.200E-1	3.027E-2	3.827E-2	-4.853E-3
Average (OFF)	---	6.400E-2	7.200E-2	9.600E-2	1.040E-1
s (OFF)	---	2.191E-2	1.789E-2	3.578E-2	2.191E-2
Average+3s (OFF)	---	1.297E-1	1.257E-1	2.033E-1	1.697E-1
Average-3s (OFF)	---	-1.727E-3	1.833E-2	-1.133E-2	3.827E-2

21. Vil_DB3

Ta= 25°C ; Vcc = 5V

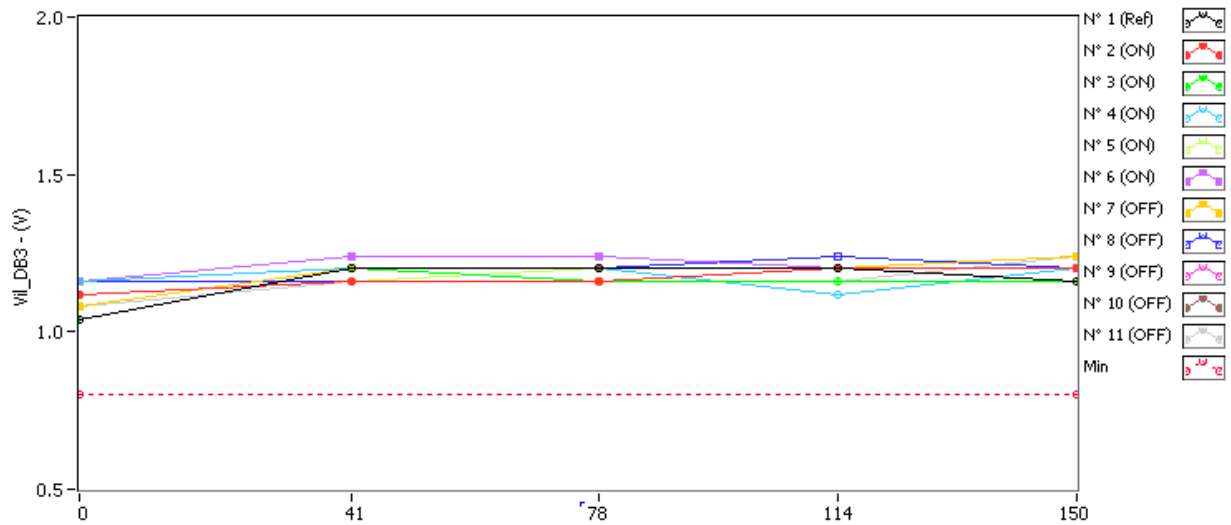

Vil_DB3 . (V) Min = 0.8

	0krad(Si)	41krad(Si)	78krad(Si)	114krad(Si)	150krad(Si)
N° 1 (Ref)	1.04	1.20	1.20	1.20	1.16
N° 2 (ON)	1.12	1.16	1.16	1.20	1.20
N° 3 (ON)	1.04	1.20	1.16	1.16	1.16
N° 4 (ON)	1.16	1.20	1.20	1.12	1.20
N° 5 (ON)	1.12	1.16	1.20	1.20	1.16
N° 6 (ON)	1.16	1.24	1.24	1.20	1.20
N° 7 (OFF)	1.08	1.20	1.16	1.20	1.24
N° 8 (OFF)	1.16	1.16	1.20	1.24	1.20
N° 9 (OFF)	1.12	1.16	1.20	1.20	1.20
N° 10 (OFF)	1.08	1.20	1.20	1.20	1.20
N° 11 (OFF)	1.08	1.16	1.16	1.16	1.24

Delta [Vil_DB3]

	0krad(Si)	41krad(Si)	78krad(Si)	114krad(Si)	150krad(Si)
N° 1 (Ref)	---	1.600E-1	1.600E-1	1.600E-1	1.200E-1
N° 2 (ON)	---	4.000E-2	4.000E-2	8.000E-2	8.000E-2
N° 3 (ON)	---	1.600E-1	1.200E-1	1.200E-1	1.200E-1
N° 4 (ON)	---	4.000E-2	4.000E-2	-4.000E-2	4.000E-2
N° 5 (ON)	---	4.000E-2	8.000E-2	8.000E-2	4.000E-2
N° 6 (ON)	---	8.000E-2	8.000E-2	4.000E-2	4.000E-2
N° 7 (OFF)	---	1.200E-1	8.000E-2	1.200E-1	1.600E-1
N° 8 (OFF)	---	0.000E+0	4.000E-2	8.000E-2	4.000E-2
N° 9 (OFF)	---	4.000E-2	8.000E-2	8.000E-2	8.000E-2
N° 10 (OFF)	---	1.200E-1	1.200E-1	1.200E-1	1.200E-1
N° 11 (OFF)	---	8.000E-2	8.000E-2	8.000E-2	1.600E-1
Average (ON)	---	7.200E-2	7.200E-2	5.600E-2	6.400E-2
s (ON)	---	5.215E-2	3.347E-2	6.066E-2	3.578E-2
Average+3s (ON)	---	2.285E-1	1.724E-1	2.380E-1	1.713E-1
Average-3s (ON)	---	-8.446E-2	-2.840E-2	-1.260E-1	-4.333E-2
Average (OFF)	---	7.200E-2	8.000E-2	9.600E-2	1.120E-1
s (OFF)	---	5.215E-2	2.828E-2	2.191E-2	5.215E-2
Average+3s (OFF)	---	2.285E-1	1.649E-1	1.617E-1	2.685E-1
Average-3s (OFF)	---	-8.446E-2	-4.853E-3	3.027E-2	-4.446E-2

22. Vil_DB4

Ta= 25°C ; Vcc = 5V

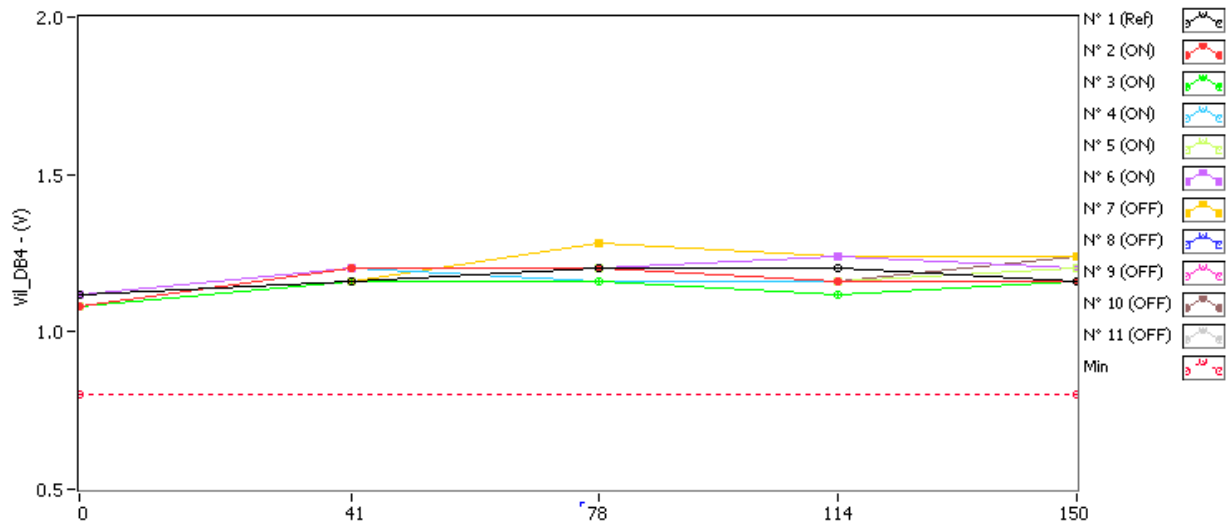

Vil_DB4 . (V) Min = 0.8

	0krad(Si)	41krad(Si)	78krad(Si)	114krad(Si)	150krad(Si)
N° 1 (Ref)	1.12	1.16	1.20	1.20	1.16
N° 2 (ON)	1.08	1.20	1.20	1.16	1.16
N° 3 (ON)	1.08	1.16	1.16	1.12	1.16
N° 4 (ON)	1.08	1.20	1.16	1.16	1.16
N° 5 (ON)	1.08	1.16	1.20	1.16	1.20
N° 6 (ON)	1.12	1.20	1.20	1.24	1.20
N° 7 (OFF)	1.08	1.16	1.28	1.24	1.24
N° 8 (OFF)	1.12	1.16	1.20	1.24	1.20
N° 9 (OFF)	1.12	1.20	1.20	1.20	1.16
N° 10 (OFF)	1.08	1.20	1.20	1.16	1.24
N° 11 (OFF)	1.12	1.16	1.20	1.20	1.16

Delta [Vil_DB4]

	0krad(Si)	41krad(Si)	78krad(Si)	114krad(Si)	150krad(Si)
N° 1 (Ref)	---	4.000E-2	8.000E-2	8.000E-2	4.000E-2
N° 2 (ON)	---	1.200E-1	1.200E-1	8.000E-2	8.000E-2
N° 3 (ON)	---	8.000E-2	8.000E-2	4.000E-2	8.000E-2
N° 4 (ON)	---	1.200E-1	8.000E-2	8.000E-2	8.000E-2
N° 5 (ON)	---	8.000E-2	1.200E-1	8.000E-2	1.200E-1
N° 6 (ON)	---	8.000E-2	8.000E-2	1.200E-1	8.000E-2
N° 7 (OFF)	---	8.000E-2	2.000E-1	1.600E-1	1.600E-1
N° 8 (OFF)	---	4.000E-2	8.000E-2	1.200E-1	8.000E-2
N° 9 (OFF)	---	8.000E-2	8.000E-2	8.000E-2	4.000E-2
N° 10 (OFF)	---	1.200E-1	1.200E-1	8.000E-2	1.600E-1
N° 11 (OFF)	---	4.000E-2	8.000E-2	8.000E-2	4.000E-2
Average (ON)	---	9.600E-2	9.600E-2	8.000E-2	8.800E-2
s (ON)	---	2.191E-2	2.191E-2	2.828E-2	1.789E-2
Average+3s (ON)	---	1.617E-1	1.617E-1	1.649E-1	1.417E-1
Average-3s (ON)	---	3.027E-2	3.027E-2	-4.853E-3	3.433E-2
Average (OFF)	---	7.200E-2	1.120E-1	1.040E-1	9.600E-2
s (OFF)	---	3.347E-2	5.215E-2	3.578E-2	6.066E-2
Average+3s (OFF)	---	1.724E-1	2.685E-1	2.113E-1	2.780E-1
Average-3s (OFF)	---	-2.840E-2	-4.446E-2	-3.331E-3	-8.599E-2

23. Vil_DB5

Ta= 25°C ; Vcc = 5V

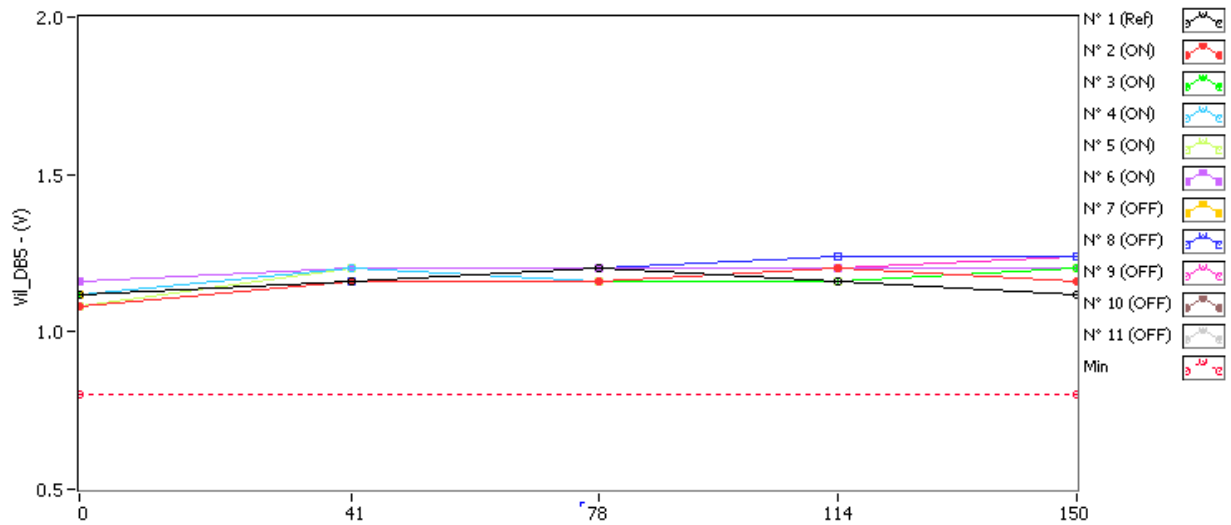

Vil_DB5 . (V) Min = 0.8

	0krad(Si)	41krad(Si)	78krad(Si)	114krad(Si)	150krad(Si)
N° 1 (Ref)	1.12	1.16	1.20	1.16	1.12
N° 2 (ON)	1.08	1.16	1.16	1.20	1.16
N° 3 (ON)	1.12	1.16	1.16	1.16	1.20
N° 4 (ON)	1.12	1.20	1.16	1.16	1.20
N° 5 (ON)	1.08	1.20	1.16	1.16	1.20
N° 6 (ON)	1.16	1.20	1.20	1.20	1.20
N° 7 (OFF)	1.12	1.20	1.20	1.20	1.20
N° 8 (OFF)	1.12	1.16	1.20	1.24	1.24
N° 9 (OFF)	1.08	1.20	1.16	1.20	1.24
N° 10 (OFF)	1.12	1.16	1.20	1.20	1.20
N° 11 (OFF)	1.12	1.16	1.16	1.20	1.20

Delta [Vil_DB5]

	0krad(Si)	41krad(Si)	78krad(Si)	114krad(Si)	150krad(Si)
N° 1 (Ref)	---	4.000E-2	8.000E-2	4.000E-2	0.000E+0
N° 2 (ON)	---	8.000E-2	8.000E-2	1.200E-1	8.000E-2
N° 3 (ON)	---	4.000E-2	4.000E-2	4.000E-2	8.000E-2
N° 4 (ON)	---	8.000E-2	4.000E-2	4.000E-2	8.000E-2
N° 5 (ON)	---	1.200E-1	8.000E-2	8.000E-2	1.200E-1
N° 6 (ON)	---	4.000E-2	4.000E-2	4.000E-2	4.000E-2
N° 7 (OFF)	---	8.000E-2	8.000E-2	8.000E-2	8.000E-2
N° 8 (OFF)	---	4.000E-2	8.000E-2	1.200E-1	1.200E-1
N° 9 (OFF)	---	1.200E-1	8.000E-2	1.200E-1	1.600E-1
N° 10 (OFF)	---	4.000E-2	8.000E-2	8.000E-2	8.000E-2
N° 11 (OFF)	---	4.000E-2	4.000E-2	8.000E-2	8.000E-2
Average (ON)	---	7.200E-2	5.600E-2	6.400E-2	8.000E-2
s (ON)	---	3.347E-2	2.191E-2	3.578E-2	2.828E-2
Average+3s (ON)	---	1.724E-1	1.217E-1	1.713E-1	1.649E-1
Average-3s (ON)	---	-2.840E-2	-9.727E-3	-4.333E-2	-4.853E-3
Average (OFF)	---	6.400E-2	7.200E-2	9.600E-2	1.040E-1
s (OFF)	---	3.578E-2	1.789E-2	2.191E-2	3.578E-2
Average+3s (OFF)	---	1.713E-1	1.257E-1	1.617E-1	2.113E-1
Average-3s (OFF)	---	-4.333E-2	1.833E-2	3.027E-2	-3.331E-3

24. Vil_DB6

Ta= 25°C ; Vcc = 5V

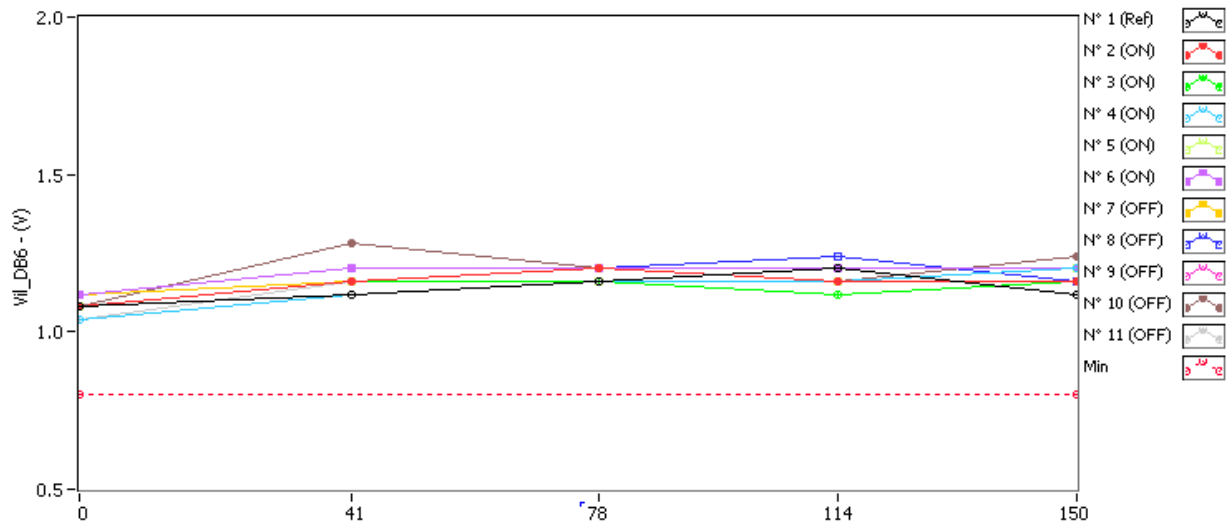

Vil_DB6 . (V) Min = 0.8

	0krad(Si)	41krad(Si)	78krad(Si)	114krad(Si)	150krad(Si)
N° 1 (Ref)	1.08	1.12	1.16	1.20	1.12
N° 2 (ON)	1.08	1.16	1.20	1.16	1.16
N° 3 (ON)	1.08	1.16	1.16	1.12	1.16
N° 4 (ON)	1.04	1.12	1.16	1.16	1.20
N° 5 (ON)	1.08	1.16	1.16	1.16	1.20
N° 6 (ON)	1.12	1.20	1.20	1.20	1.20
N° 7 (OFF)	1.12	1.16	1.20	1.16	1.20
N° 8 (OFF)	1.12	1.20	1.20	1.24	1.16
N° 9 (OFF)	1.08	1.16	1.20	1.20	1.20
N° 10 (OFF)	1.08	1.28	1.20	1.16	1.24
N° 11 (OFF)	1.04	1.16	1.20	1.20	1.20

Delta [Vil_DB6]

	0krad(Si)	41krad(Si)	78krad(Si)	114krad(Si)	150krad(Si)
N° 1 (Ref)	---	4.000E-2	8.000E-2	1.200E-1	4.000E-2
N° 2 (ON)	---	8.000E-2	1.200E-1	8.000E-2	8.000E-2
N° 3 (ON)	---	8.000E-2	8.000E-2	4.000E-2	8.000E-2
N° 4 (ON)	---	8.000E-2	1.200E-1	1.200E-1	1.600E-1
N° 5 (ON)	---	8.000E-2	8.000E-2	8.000E-2	1.200E-1
N° 6 (ON)	---	8.000E-2	8.000E-2	8.000E-2	8.000E-2
N° 7 (OFF)	---	4.000E-2	8.000E-2	4.000E-2	8.000E-2
N° 8 (OFF)	---	8.000E-2	8.000E-2	1.200E-1	4.000E-2
N° 9 (OFF)	---	8.000E-2	1.200E-1	1.200E-1	1.200E-1
N° 10 (OFF)	---	2.000E-1	1.200E-1	8.000E-2	1.600E-1
N° 11 (OFF)	---	1.200E-1	1.600E-1	1.600E-1	1.600E-1
Average (ON)	---	8.000E-2	9.600E-2	8.000E-2	1.040E-1
s (ON)	---	9.935E-17	2.191E-2	2.828E-2	3.578E-2
Average+3s (ON)	---	8.000E-2	1.617E-1	1.649E-1	2.113E-1
Average-3s (ON)	---	8.000E-2	3.027E-2	-4.853E-3	-3.331E-3
Average (OFF)	---	1.040E-1	1.120E-1	1.040E-1	1.120E-1
s (OFF)	---	6.066E-2	3.347E-2	4.561E-2	5.215E-2
Average+3s (OFF)	---	2.860E-1	2.124E-1	2.408E-1	2.685E-1
Average-3s (OFF)	---	-7.799E-2	1.160E-2	-3.282E-2	-4.446E-2

25. Vil_DB7

Ta= 25°C ; Vcc = 5V

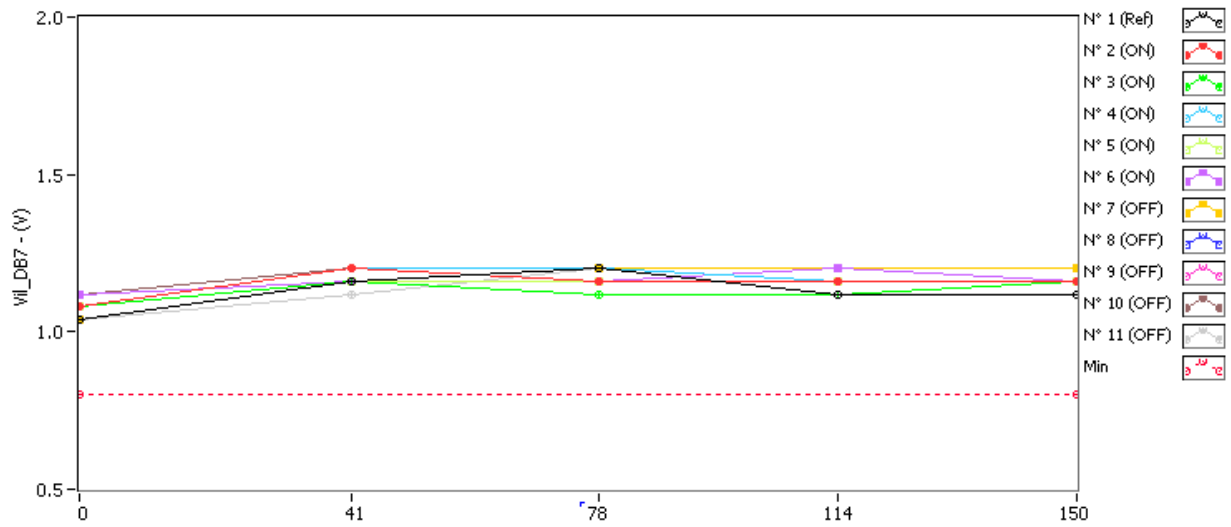

Vil_DB7 . (V) Min = 0.8

	0krad(Si)	41krad(Si)	78krad(Si)	114krad(Si)	150krad(Si)
N° 1 (Ref)	1.04	1.16	1.20	1.12	1.12
N° 2 (ON)	1.08	1.20	1.16	1.16	1.16
N° 3 (ON)	1.08	1.16	1.12	1.12	1.16
N° 4 (ON)	1.08	1.20	1.20	1.16	1.16
N° 5 (ON)	1.08	1.16	1.16	1.16	1.16
N° 6 (ON)	1.12	1.16	1.16	1.20	1.16
N° 7 (OFF)	1.04	1.16	1.20	1.20	1.20
N° 8 (OFF)	1.08	1.16	1.20	1.20	1.16
N° 9 (OFF)	1.08	1.16	1.20	1.20	1.16
N° 10 (OFF)	1.12	1.20	1.20	1.20	1.20
N° 11 (OFF)	1.04	1.12	1.20	1.16	1.16

Delta [Vil_DB7]

	0krad(Si)	41krad(Si)	78krad(Si)	114krad(Si)	150krad(Si)
N° 1 (Ref)	---	1.200E-1	1.600E-1	8.000E-2	8.000E-2
N° 2 (ON)	---	1.200E-1	8.000E-2	8.000E-2	8.000E-2
N° 3 (ON)	---	8.000E-2	4.000E-2	4.000E-2	8.000E-2
N° 4 (ON)	---	1.200E-1	1.200E-1	8.000E-2	8.000E-2
N° 5 (ON)	---	8.000E-2	8.000E-2	8.000E-2	8.000E-2
N° 6 (ON)	---	4.000E-2	4.000E-2	8.000E-2	4.000E-2
N° 7 (OFF)	---	1.200E-1	1.600E-1	1.600E-1	1.600E-1
N° 8 (OFF)	---	8.000E-2	1.200E-1	1.200E-1	8.000E-2
N° 9 (OFF)	---	8.000E-2	1.200E-1	1.200E-1	8.000E-2
N° 10 (OFF)	---	8.000E-2	8.000E-2	8.000E-2	8.000E-2
N° 11 (OFF)	---	8.000E-2	1.600E-1	1.200E-1	1.200E-1
Average (ON)	---	8.800E-2	7.200E-2	7.200E-2	7.200E-2
s (ON)	---	3.347E-2	3.347E-2	1.789E-2	1.789E-2
Average+3s (ON)	---	1.884E-1	1.724E-1	1.257E-1	1.257E-1
Average-3s (ON)	---	-1.240E-2	-2.840E-2	1.833E-2	1.833E-2
Average (OFF)	---	8.800E-2	1.280E-1	1.200E-1	1.040E-1
s (OFF)	---	1.789E-2	3.347E-2	2.828E-2	3.578E-2
Average+3s (OFF)	---	1.417E-1	2.284E-1	2.049E-1	2.113E-1
Average-3s (OFF)	---	3.433E-2	2.760E-2	3.515E-2	-3.331E-3

26. Vil_CS

Ta= 25°C ; Vcc = 5V

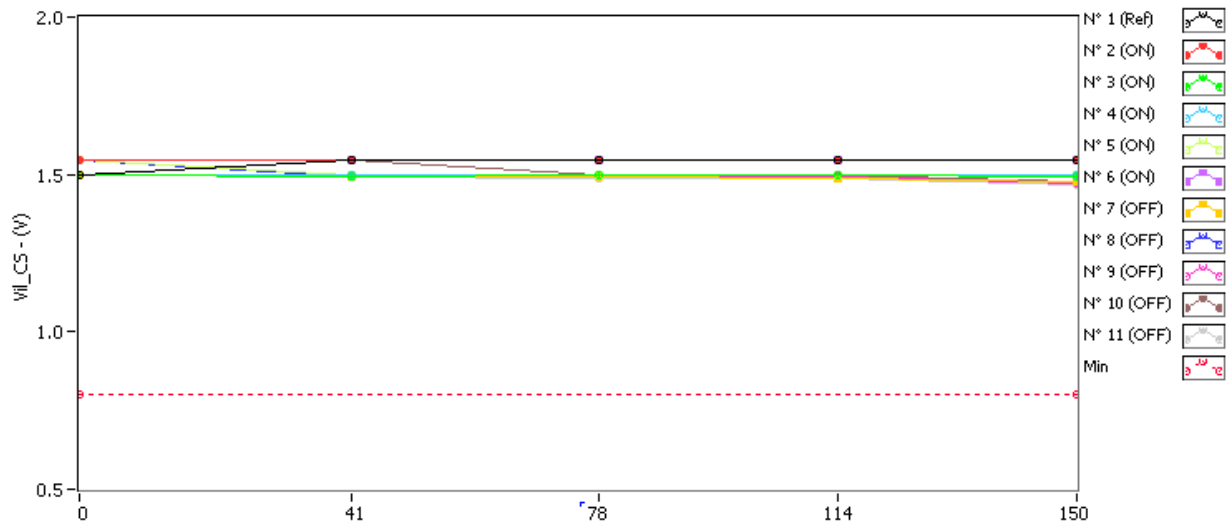

Vil_CS . (V) Min = 0.8

	0krad(Si)	41krad(Si)	78krad(Si)	114krad(Si)	150krad(Si)
N° 1 (Ref)	1.498	1.544	1.544	1.544	1.544
N° 2 (ON)	1.544	1.544	1.544	1.544	1.544
N° 3 (ON)	1.496	1.494	1.499	1.496	1.495
N° 4 (ON)	1.499	1.497	1.498	1.497	1.496
N° 5 (ON)	1.544	1.498	1.499	1.499	1.497
N° 6 (ON)	1.544	1.544	1.544	1.544	1.544
N° 7 (OFF)	1.497	1.494	1.494	1.488	1.479
N° 8 (OFF)	1.544	1.494	1.494	1.489	1.477
N° 9 (OFF)	1.544	1.494	1.494	1.494	1.474
N° 10 (OFF)	1.544	1.544	1.499	1.497	1.475
N° 11 (OFF)	1.544	1.494	1.489	1.487	1.468

Delta [Vil_CS]

	0krad(Si)	41krad(Si)	78krad(Si)	114krad(Si)	150krad(Si)
N° 1 (Ref)	---	4.600E-2	4.600E-2	4.600E-2	4.600E-2
N° 2 (ON)	---	0.000E+0	0.000E+0	0.000E+0	0.000E+0
N° 3 (ON)	---	-2.000E-3	3.000E-3	0.000E+0	-1.000E-3
N° 4 (ON)	---	-2.000E-3	-1.000E-3	-2.000E-3	-3.000E-3
N° 5 (ON)	---	-4.600E-2	-4.500E-2	-4.500E-2	-4.700E-2
N° 6 (ON)	---	0.000E+0	0.000E+0	0.000E+0	0.000E+0
N° 7 (OFF)	---	-3.000E-3	-3.000E-3	-9.000E-3	-1.800E-2
N° 8 (OFF)	---	-5.000E-2	-5.000E-2	-5.500E-2	-6.700E-2
N° 9 (OFF)	---	-5.000E-2	-5.000E-2	-5.000E-2	-7.000E-2
N° 10 (OFF)	---	0.000E+0	-4.500E-2	-4.700E-2	-6.900E-2
N° 11 (OFF)	---	-5.000E-2	-5.500E-2	-5.700E-2	-7.600E-2
Average (ON)	---	-1.000E-2	-8.600E-3	-9.400E-3	-1.020E-2
s (ON)	---	2.015E-2	2.040E-2	1.992E-2	2.061E-2
Average+3s (ON)	---	5.045E-2	5.261E-2	5.036E-2	5.162E-2
Average-3s (ON)	---	-7.045E-2	-6.981E-2	-6.916E-2	-7.202E-2
Average (OFF)	---	-3.060E-2	-4.060E-2	-4.360E-2	-6.000E-2
s (OFF)	---	2.659E-2	2.131E-2	1.974E-2	2.372E-2
Average+3s (OFF)	---	4.916E-2	2.334E-2	1.563E-2	1.115E-2
Average-3s (OFF)	---	-1.104E-1	-1.045E-1	-1.028E-1	-1.312E-1

27. Vil_CE

Ta= 25°C ; Vcc = 5V

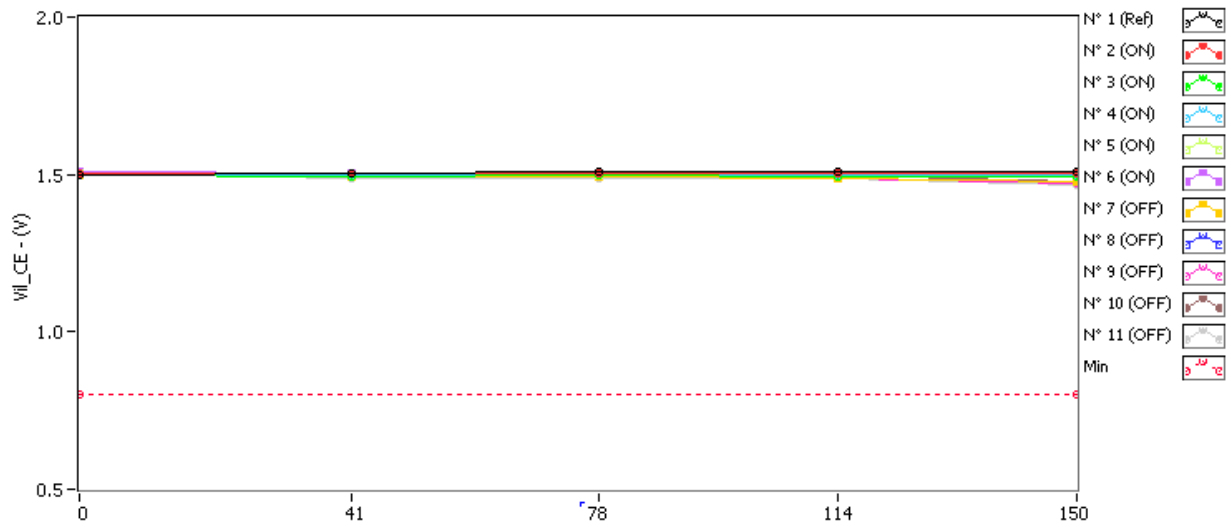

Vil_CE . (V) Min = 0.8

	0krad(Si)	41krad(Si)	78krad(Si)	114krad(Si)	150krad(Si)
N° 1 (Ref)	1.498	1.506	1.509	1.507	1.511
N° 2 (ON)	1.504	1.502	1.503	1.501	1.503
N° 3 (ON)	1.496	1.494	1.496	1.494	1.494
N° 4 (ON)	1.498	1.496	1.498	1.496	1.496
N° 5 (ON)	1.501	1.498	1.499	1.499	1.496
N° 6 (ON)	1.507	1.502	1.505	1.505	1.501
N° 7 (OFF)	1.497	1.492	1.491	1.490	1.479
N° 8 (OFF)	1.508	1.493	1.492	1.489	1.477
N° 9 (OFF)	1.506	1.492	1.492	1.489	1.474
N° 10 (OFF)	1.511	1.500	1.499	1.497	1.475
N° 11 (OFF)	1.503	1.490	1.489	1.489	1.468

Delta [Vil_CE]

	0krad(Si)	41krad(Si)	78krad(Si)	114krad(Si)	150krad(Si)
N° 1 (Ref)	---	8.000E-3	1.100E-2	9.000E-3	1.300E-2
N° 2 (ON)	---	-2.000E-3	-1.000E-3	-3.000E-3	-1.000E-3
N° 3 (ON)	---	-2.000E-3	0.000E+0	-2.000E-3	-2.000E-3
N° 4 (ON)	---	-2.000E-3	0.000E+0	-2.000E-3	-2.000E-3
N° 5 (ON)	---	-3.000E-3	-2.000E-3	-2.000E-3	-5.000E-3
N° 6 (ON)	---	-5.000E-3	-2.000E-3	-2.000E-3	-6.000E-3
N° 7 (OFF)	---	-5.000E-3	-6.000E-3	-7.000E-3	-1.800E-2
N° 8 (OFF)	---	-1.500E-2	-1.600E-2	-1.900E-2	-3.100E-2
N° 9 (OFF)	---	-1.400E-2	-1.400E-2	-1.700E-2	-3.200E-2
N° 10 (OFF)	---	-1.100E-2	-1.200E-2	-1.400E-2	-3.600E-2
N° 11 (OFF)	---	-1.300E-2	-1.400E-2	-1.400E-2	-3.500E-2
Average (ON)	---	-2.800E-3	-1.000E-3	-2.200E-3	-3.200E-3
s (ON)	---	1.304E-3	1.000E-3	4.472E-4	2.168E-3
Average+3s (ON)	---	1.112E-3	2.000E-3	-8.584E-4	3.304E-3
Average-3s (ON)	---	-6.712E-3	-4.000E-3	-3.542E-3	-9.704E-3
Average (OFF)	---	-1.160E-2	-1.240E-2	-1.420E-2	-3.040E-2
s (OFF)	---	3.975E-3	3.847E-3	4.550E-3	7.232E-3
Average+3s (OFF)	---	3.248E-4	-8.588E-4	-5.508E-4	-8.704E-3
Average-3s (OFF)	---	-2.352E-2	-2.394E-2	-2.785E-2	-5.210E-2

28. Iih_DBO

Ta = 25°C ; Vcc = 5V ; Vin = 5V

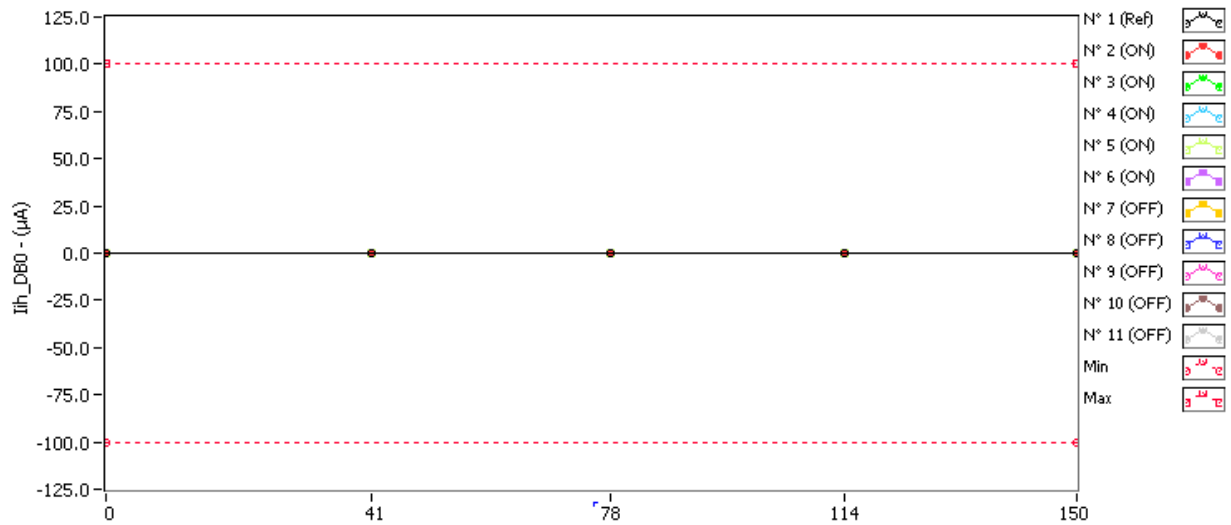

Iih_DBO . (µA) Min = -100.0 Max = 100.0

	0krad(Si)	41krad(Si)	78krad(Si)	114krad(Si)	150krad(Si)
N° 1 (Ref)	3.101E-4	2.599E-4	2.794E-4	2.695E-4	2.170E-4
N° 2 (ON)	2.783E-4	2.388E-4	2.875E-4	3.008E-4	3.014E-4
N° 3 (ON)	2.915E-4	2.485E-4	2.903E-4	2.999E-4	3.152E-4
N° 4 (ON)	2.951E-4	2.513E-4	2.963E-4	3.074E-4	3.267E-4
N° 5 (ON)	3.043E-4	2.539E-4	3.053E-4	3.189E-4	3.282E-4
N° 6 (ON)	2.814E-4	2.522E-4	2.955E-4	3.036E-4	3.229E-4
N° 7 (OFF)	2.935E-4	2.552E-4	2.710E-4	2.701E-4	2.977E-4
N° 8 (OFF)	2.264E-4	2.323E-4	2.705E-4	2.702E-4	3.066E-4
N° 9 (OFF)	2.304E-4	2.334E-4	2.729E-4	2.730E-4	3.613E-4
N° 10 (OFF)	2.481E-4	2.429E-4	2.839E-4	2.826E-4	3.716E-4
N° 11 (OFF)	2.419E-4	2.352E-4	2.779E-4	2.754E-4	3.498E-4

Delta [Iih_DBO]

	0krad(Si)	41krad(Si)	78krad(Si)	114krad(Si)	150krad(Si)
N° 1 (Ref)	---	-5.014E-5	-3.068E-5	-4.056E-5	-9.309E-5
N° 2 (ON)	---	-3.954E-5	9.187E-6	2.253E-5	2.306E-5
N° 3 (ON)	---	-4.301E-5	-1.207E-6	8.336E-6	2.369E-5
N° 4 (ON)	---	-4.378E-5	1.165E-6	1.235E-5	3.158E-5
N° 5 (ON)	---	-5.042E-5	1.008E-6	1.456E-5	2.387E-5
N° 6 (ON)	---	-2.921E-5	1.404E-5	2.218E-5	4.147E-5
N° 7 (OFF)	---	-3.835E-5	-2.252E-5	-2.341E-5	4.165E-6
N° 8 (OFF)	---	5.902E-6	4.411E-5	4.386E-5	8.026E-5
N° 9 (OFF)	---	3.043E-6	4.253E-5	4.263E-5	1.309E-4
N° 10 (OFF)	---	-5.160E-6	3.578E-5	3.451E-5	1.235E-4
N° 11 (OFF)	---	-6.666E-6	3.599E-5	3.353E-5	1.080E-4
Average (ON)	---	-4.119E-5	4.839E-6	1.599E-5	2.873E-5
s (ON)	---	7.768E-6	6.487E-6	6.223E-6	7.931E-6
Average+3s (ON)	---	-1.789E-5	2.430E-5	3.466E-5	5.253E-5
Average-3s (ON)	---	-6.449E-5	-1.462E-5	-2.676E-6	4.939E-6
Average (OFF)	---	-8.246E-6	2.718E-5	2.622E-5	8.937E-5
s (OFF)	---	1.765E-5	2.804E-5	2.813E-5	5.143E-5
Average+3s (OFF)	---	4.470E-5	1.113E-4	1.106E-4	2.437E-4
Average-3s (OFF)	---	-6.119E-5	-5.693E-5	-5.817E-5	-6.493E-5

29. lih_DB1

Ta= 25°C ; Vcc = 5V ; Vin = 5V

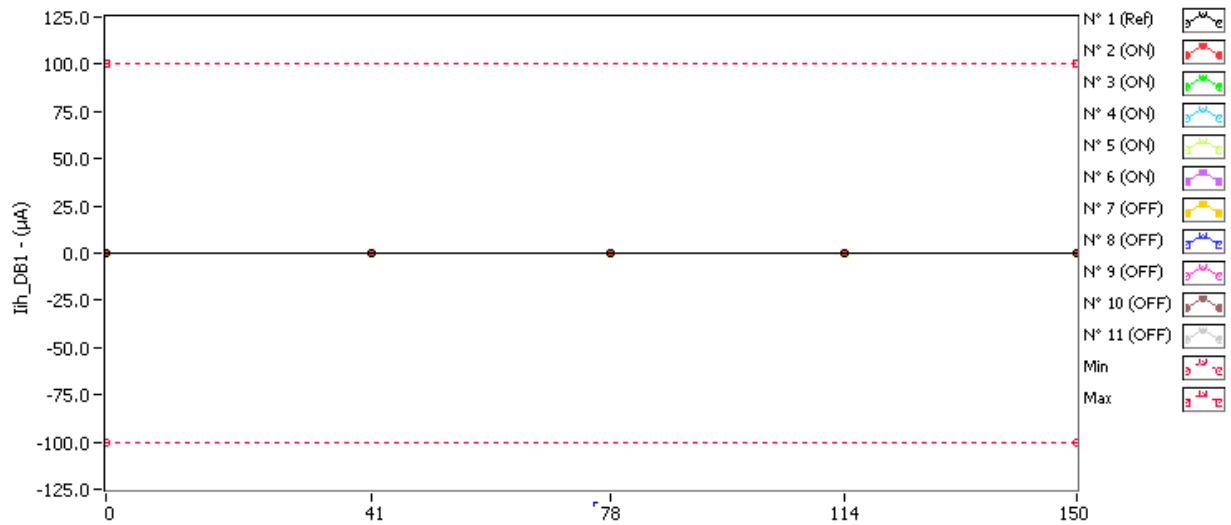

lih_DB1 . (µA) Min = -100.0 Max = 100.0

	0krad(Si)	41krad(Si)	78krad(Si)	114krad(Si)	150krad(Si)
N° 1 (Ref)	3.253E-4	2.742E-4	2.895E-4	2.840E-4	2.368E-4
N° 2 (ON)	2.961E-4	2.521E-4	3.001E-4	3.161E-4	3.196E-4
N° 3 (ON)	3.047E-4	2.607E-4	2.990E-4	3.150E-4	3.226E-4
N° 4 (ON)	3.084E-4	2.613E-4	3.051E-4	3.198E-4	3.522E-4
N° 5 (ON)	3.173E-4	2.445E-4	3.139E-4	3.293E-4	3.453E-4
N° 6 (ON)	2.936E-4	2.743E-4	3.035E-4	3.146E-4	3.437E-4
N° 7 (OFF)	3.058E-4	2.514E-4	2.762E-4	2.802E-4	3.080E-4
N° 8 (OFF)	2.442E-4	2.422E-4	2.761E-4	2.804E-4	3.192E-4
N° 9 (OFF)	2.473E-4	2.431E-4	2.776E-4	2.778E-4	3.718E-4
N° 10 (OFF)	2.621E-4	2.533E-4	2.892E-4	2.909E-4	3.881E-4
N° 11 (OFF)	2.616E-4	2.476E-4	2.836E-4	2.846E-4	3.621E-4

Delta [lih_DB1]

	0krad(Si)	41krad(Si)	78krad(Si)	114krad(Si)	150krad(Si)
N° 1 (Ref)	---	-5.105E-5	-3.580E-5	-4.128E-5	-8.845E-5
N° 2 (ON)	---	-4.400E-5	3.913E-6	1.999E-5	2.342E-5
N° 3 (ON)	---	-4.396E-5	-5.658E-6	1.033E-5	1.789E-5
N° 4 (ON)	---	-4.716E-5	-3.282E-6	1.139E-5	4.381E-5
N° 5 (ON)	---	-7.275E-5	-3.401E-6	1.198E-5	2.804E-5
N° 6 (ON)	---	-1.926E-5	9.976E-6	2.105E-5	5.011E-5
N° 7 (OFF)	---	-5.441E-5	-2.957E-5	-2.564E-5	2.217E-6
N° 8 (OFF)	---	-1.983E-6	3.195E-5	3.620E-5	7.503E-5
N° 9 (OFF)	---	-4.251E-6	3.030E-5	3.047E-5	1.245E-4
N° 10 (OFF)	---	-8.787E-6	2.713E-5	2.881E-5	1.260E-4
N° 11 (OFF)	---	-1.403E-5	2.203E-5	2.301E-5	1.005E-4
Average (ON)	---	-4.542E-5	3.096E-7	1.495E-5	3.265E-5
s (ON)	---	1.896E-5	6.494E-6	5.133E-6	1.373E-5
Average+3s (ON)	---	1.146E-5	1.979E-5	3.035E-5	7.384E-5
Average-3s (ON)	---	-1.023E-4	-1.917E-5	-4.502E-7	-8.531E-6
Average (OFF)	---	-1.669E-5	1.637E-5	1.857E-5	8.564E-5
s (OFF)	---	2.158E-5	2.596E-5	2.516E-5	5.106E-5
Average+3s (OFF)	---	4.806E-5	9.424E-5	9.404E-5	2.388E-4
Average-3s (OFF)	---	-8.145E-5	-6.150E-5	-5.690E-5	-6.754E-5

30. lih_DB2

Ta= 25°C ; Vcc = 5V ; Vin = 5V

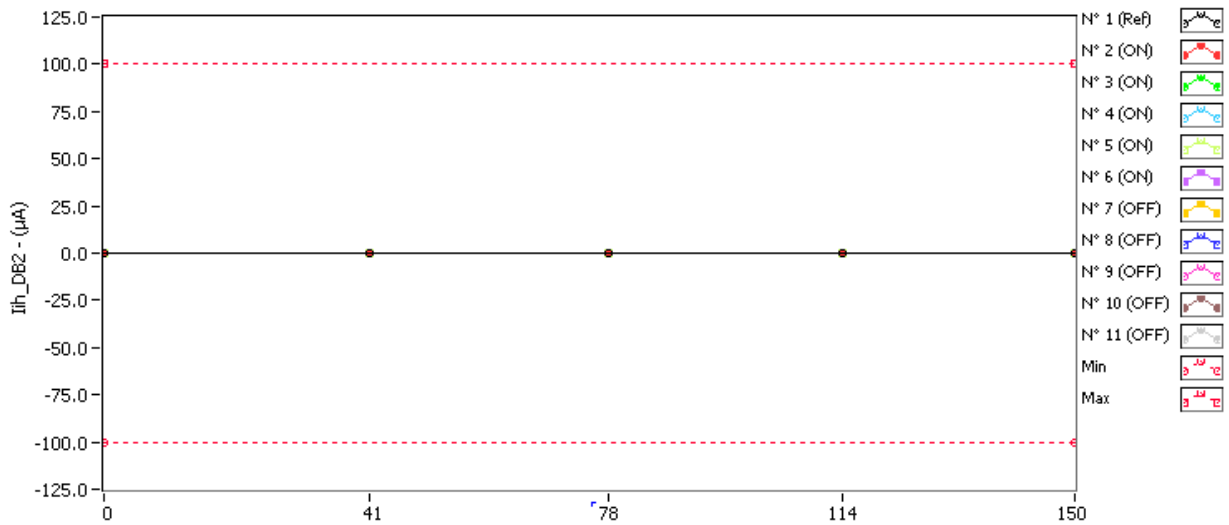

lih_DB2 . (µA) Min = -100.0 Max = 100.0

	0krad(Si)	41krad(Si)	78krad(Si)	114krad(Si)	150krad(Si)
N° 1 (Ref)	3.381E-4	2.870E-4	3.011E-4	2.971E-4	2.520E-4
N° 2 (ON)	3.087E-4	2.563E-4	3.022E-4	3.208E-4	3.250E-4
N° 3 (ON)	3.200E-4	2.648E-4	3.044E-4	3.214E-4	3.332E-4
N° 4 (ON)	3.231E-4	2.707E-4	3.121E-4	3.275E-4	3.582E-4
N° 5 (ON)	3.301E-4	2.765E-4	3.220E-4	3.210E-4	3.548E-4
N° 6 (ON)	3.030E-4	2.588E-4	3.098E-4	3.241E-4	3.438E-4
N° 7 (OFF)	3.164E-4	2.328E-4	2.813E-4	2.845E-4	3.137E-4
N° 8 (OFF)	2.565E-4	2.494E-4	2.828E-4	2.848E-4	3.246E-4
N° 9 (OFF)	2.610E-4	2.511E-4	2.840E-4	2.883E-4	3.460E-4
N° 10 (OFF)	2.794E-4	2.616E-4	2.959E-4	2.957E-4	3.965E-4
N° 11 (OFF)	2.716E-4	2.547E-4	2.894E-4	2.920E-4	3.733E-4

Delta [lih_DB2]

	0krad(Si)	41krad(Si)	78krad(Si)	114krad(Si)	150krad(Si)
N° 1 (Ref)	---	-5.109E-5	-3.705E-5	-4.098E-5	-8.610E-5
N° 2 (ON)	---	-5.239E-5	-6.508E-6	1.210E-5	1.624E-5
N° 3 (ON)	---	-5.518E-5	-1.557E-5	1.411E-6	1.318E-5
N° 4 (ON)	---	-5.236E-5	-1.104E-5	4.430E-6	3.507E-5
N° 5 (ON)	---	-5.362E-5	-8.122E-6	-9.159E-6	2.464E-5
N° 6 (ON)	---	-4.419E-5	6.762E-6	2.105E-5	4.077E-5
N° 7 (OFF)	---	-8.362E-5	-3.513E-5	-3.190E-5	-2.730E-6
N° 8 (OFF)	---	-7.097E-6	2.628E-5	2.830E-5	6.812E-5
N° 9 (OFF)	---	-9.931E-6	2.299E-5	2.729E-5	8.497E-5
N° 10 (OFF)	---	-1.776E-5	1.659E-5	1.635E-5	1.172E-4
N° 11 (OFF)	---	-1.691E-5	1.776E-5	2.035E-5	1.016E-4
Average (ON)	---	-5.155E-5	-6.895E-6	5.967E-6	2.598E-5
s (ON)	---	4.273E-6	8.376E-6	1.137E-5	1.185E-5
Average+3s (ON)	---	-3.873E-5	1.823E-5	4.008E-5	6.153E-5
Average-3s (ON)	---	-6.437E-5	-3.202E-5	-2.814E-5	-9.577E-6
Average (OFF)	---	-2.706E-5	9.699E-6	1.208E-5	7.383E-5
s (OFF)	---	3.194E-5	2.537E-5	2.508E-5	4.655E-5
Average+3s (OFF)	---	6.875E-5	8.580E-5	8.730E-5	2.135E-4
Average-3s (OFF)	---	-1.229E-4	-6.640E-5	-6.315E-5	-6.583E-5

31. lih_DB3

Ta= 25°C ; Vcc = 5V ; Vin = 5V

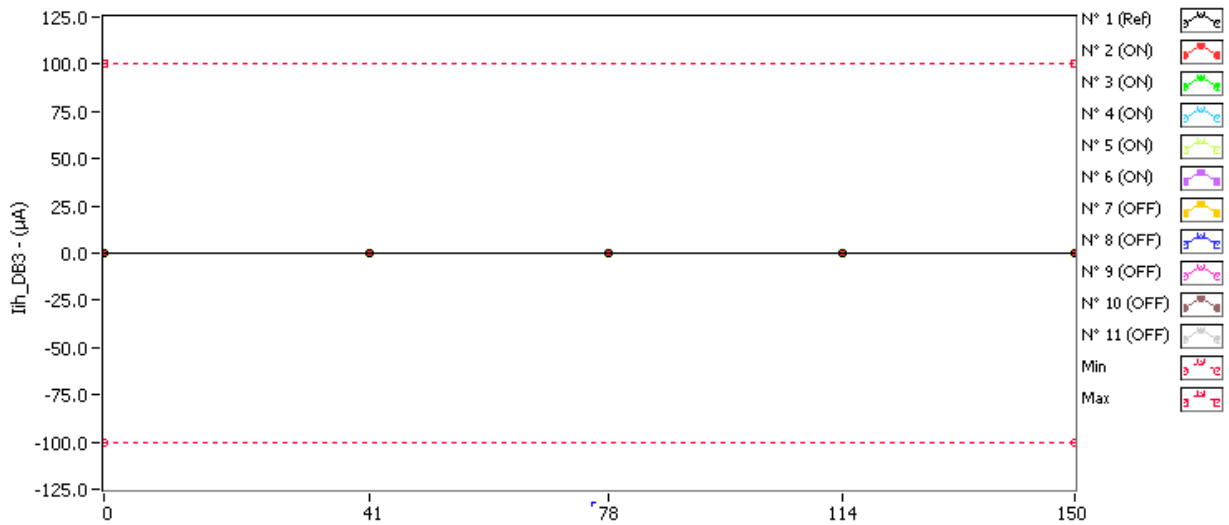

lih_DB3 . (µA) Min = -100.0 Max = 100.0

	0krad(Si)	41krad(Si)	78krad(Si)	114krad(Si)	150krad(Si)
N° 1 (Ref)	3.348E-4	2.831E-4	2.985E-4	2.905E-4	2.527E-4
N° 2 (ON)	3.030E-4	2.455E-4	2.858E-4	3.079E-4	3.264E-4
N° 3 (ON)	3.095E-4	2.620E-4	2.917E-4	3.126E-4	3.309E-4
N° 4 (ON)	3.143E-4	2.567E-4	2.963E-4	3.195E-4	3.624E-4
N° 5 (ON)	3.210E-4	2.607E-4	3.034E-4	3.271E-4	3.548E-4
N° 6 (ON)	2.989E-4	2.488E-4	2.906E-4	3.133E-4	3.416E-4
N° 7 (OFF)	3.082E-4	2.348E-4	2.697E-4	2.775E-4	3.049E-4
N° 8 (OFF)	2.533E-4	2.438E-4	2.744E-4	2.739E-4	3.197E-4
N° 9 (OFF)	2.587E-4	2.484E-4	2.765E-4	2.801E-4	3.432E-4
N° 10 (OFF)	2.780E-4	2.586E-4	2.885E-4	2.916E-4	3.874E-4
N° 11 (OFF)	2.707E-4	2.497E-4	2.820E-4	2.832E-4	3.650E-4

Delta [lih_DB3]

	0krad(Si)	41krad(Si)	78krad(Si)	114krad(Si)	150krad(Si)
N° 1 (Ref)	---	-5.169E-5	-3.627E-5	-4.431E-5	-8.208E-5
N° 2 (ON)	---	-5.747E-5	-1.722E-5	4.908E-6	2.343E-5
N° 3 (ON)	---	-4.746E-5	-1.777E-5	3.134E-6	2.143E-5
N° 4 (ON)	---	-5.757E-5	-1.801E-5	5.188E-6	4.806E-5
N° 5 (ON)	---	-6.029E-5	-1.757E-5	6.054E-6	3.378E-5
N° 6 (ON)	---	-5.006E-5	-8.298E-6	1.444E-5	4.270E-5
N° 7 (OFF)	---	-7.340E-5	-3.854E-5	-3.069E-5	-3.309E-6
N° 8 (OFF)	---	-9.417E-6	2.116E-5	2.068E-5	6.640E-5
N° 9 (OFF)	---	-1.035E-5	1.776E-5	2.141E-5	8.442E-5
N° 10 (OFF)	---	-1.940E-5	1.055E-5	1.364E-5	1.094E-4
N° 11 (OFF)	---	-2.109E-5	1.125E-5	1.244E-5	9.430E-5
Average (ON)	---	-5.457E-5	-1.578E-5	6.744E-6	3.388E-5
s (ON)	---	5.501E-6	4.190E-6	4.430E-6	1.165E-5
Average+3s (ON)	---	-3.807E-5	-3.205E-6	2.003E-5	6.883E-5
Average-3s (ON)	---	-7.107E-5	-2.835E-5	-6.545E-6	-1.066E-6
Average (OFF)	---	-2.673E-5	4.438E-6	7.494E-6	7.024E-5
s (OFF)	---	2.661E-5	2.443E-5	2.172E-5	4.398E-5
Average+3s (OFF)	---	5.309E-5	7.774E-5	7.267E-5	2.022E-4
Average-3s (OFF)	---	-1.066E-4	-6.886E-5	-5.768E-5	-6.171E-5

32. Iih_DB4

Ta= 25°C ; Vcc = 5V ; Vin = 5V

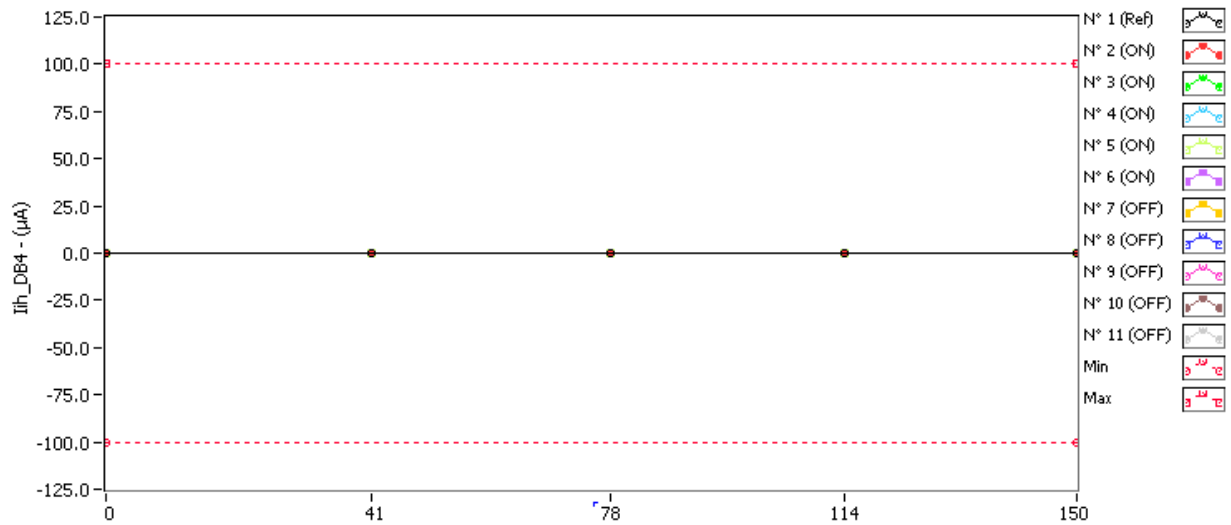

Iih_DB4 . (µA) Min = -100.0 Max = 100.0

	0krad(Si)	41krad(Si)	78krad(Si)	114krad(Si)	150krad(Si)
N° 1 (Ref)	3.179E-4	2.853E-4	2.944E-4	2.904E-4	2.608E-4
N° 2 (ON)	2.934E-4	2.504E-4	2.862E-4	3.085E-4	3.183E-4
N° 3 (ON)	3.067E-4	2.598E-4	2.923E-4	3.101E-4	3.254E-4
N° 4 (ON)	3.125E-4	2.630E-4	2.970E-4	3.156E-4	3.683E-4
N° 5 (ON)	3.182E-4	2.704E-4	3.061E-4	3.140E-4	3.446E-4
N° 6 (ON)	2.903E-4	2.549E-4	2.904E-4	3.049E-4	3.157E-4
N° 7 (OFF)	3.026E-4	2.493E-4	2.632E-4	2.687E-4	3.011E-4
N° 8 (OFF)	2.559E-4	2.371E-4	2.600E-4	2.679E-4	3.128E-4
N° 9 (OFF)	2.603E-4	2.407E-4	2.672E-4	2.719E-4	3.192E-4
N° 10 (OFF)	2.771E-4	2.518E-4	2.763E-4	2.843E-4	3.812E-4
N° 11 (OFF)	2.717E-4	2.433E-4	2.707E-4	2.758E-4	3.564E-4

Delta [Iih_DB4]

	0krad(Si)	41krad(Si)	78krad(Si)	114krad(Si)	150krad(Si)
N° 1 (Ref)	---	-3.261E-5	-2.356E-5	-2.753E-5	-5.712E-5
N° 2 (ON)	---	-4.300E-5	-7.166E-6	1.505E-5	2.486E-5
N° 3 (ON)	---	-4.696E-5	-1.439E-5	3.376E-6	1.863E-5
N° 4 (ON)	---	-4.952E-5	-1.551E-5	3.085E-6	5.576E-5
N° 5 (ON)	---	-4.775E-5	-1.204E-5	-4.208E-6	2.647E-5
N° 6 (ON)	---	-3.542E-5	5.500E-8	1.457E-5	2.543E-5
N° 7 (OFF)	---	-5.327E-5	-3.938E-5	-3.387E-5	-1.499E-6
N° 8 (OFF)	---	-1.886E-5	4.056E-6	1.202E-5	5.691E-5
N° 9 (OFF)	---	-1.962E-5	6.863E-6	1.163E-5	5.885E-5
N° 10 (OFF)	---	-2.529E-5	-8.450E-7	7.218E-6	1.041E-4
N° 11 (OFF)	---	-2.849E-5	-1.086E-6	4.065E-6	8.468E-5
Average (ON)	---	-4.453E-5	-9.811E-6	6.374E-6	3.023E-5
s (ON)	---	5.623E-6	6.379E-6	8.279E-6	1.460E-5
Average+3s (ON)	---	-2.766E-5	9.327E-6	3.121E-5	7.403E-5
Average-3s (ON)	---	-6.140E-5	-2.895E-5	-1.846E-5	-1.357E-5
Average (OFF)	---	-2.910E-5	-6.079E-6	2.154E-7	6.060E-5
s (OFF)	---	1.409E-5	1.892E-5	1.933E-5	3.982E-5
Average+3s (OFF)	---	1.317E-5	5.068E-5	5.822E-5	1.801E-4
Average-3s (OFF)	---	-7.138E-5	-6.284E-5	-5.779E-5	-5.885E-5

33. lih_DB5

Ta= 25°C ; Vcc = 5V ; Vin = 5V

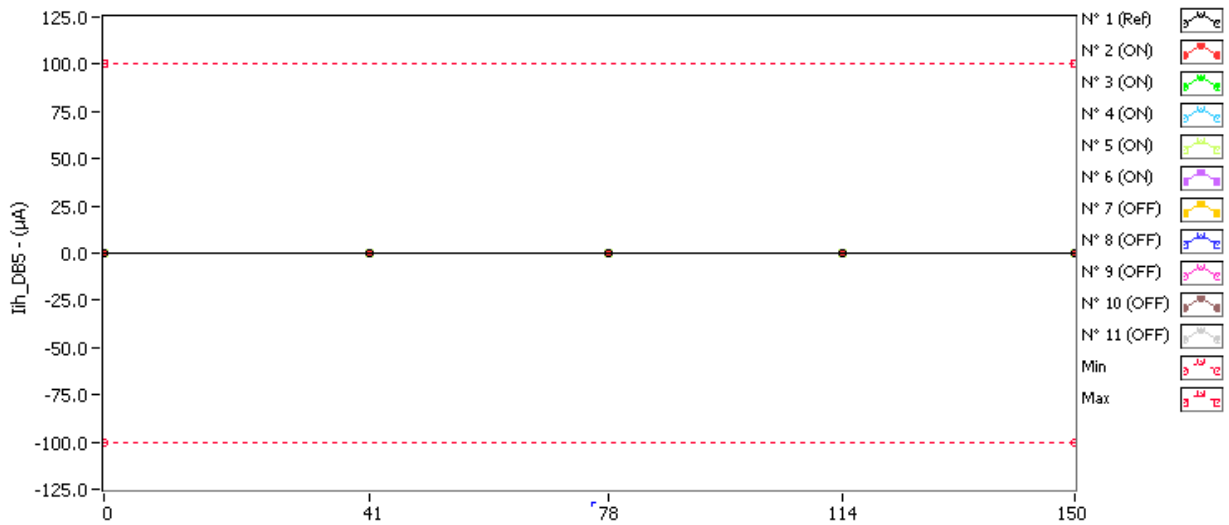

lih_DB5 . (µA) Min = -100.0 Max = 100.0

	0krad(Si)	41krad(Si)	78krad(Si)	114krad(Si)	150krad(Si)
N° 1 (Ref)	3.400E-4	2.944E-4	3.054E-4	3.003E-4	2.647E-4
N° 2 (ON)	3.127E-4	2.505E-4	2.873E-4	3.149E-4	3.288E-4
N° 3 (ON)	3.173E-4	2.567E-4	2.910E-4	3.144E-4	3.306E-4
N° 4 (ON)	3.251E-4	2.689E-4	2.995E-4	3.225E-4	3.476E-4
N° 5 (ON)	3.295E-4	2.669E-4	3.061E-4	3.177E-4	3.518E-4
N° 6 (ON)	3.030E-4	2.491E-4	2.905E-4	3.125E-4	3.556E-4
N° 7 (OFF)	3.159E-4	2.485E-4	2.739E-4	2.775E-4	3.175E-4
N° 8 (OFF)	2.597E-4	2.451E-4	2.706E-4	2.775E-4	3.216E-4
N° 9 (OFF)	2.710E-4	2.519E-4	2.767E-4	2.796E-4	3.411E-4
N° 10 (OFF)	2.864E-4	2.622E-4	2.877E-4	2.960E-4	3.930E-4
N° 11 (OFF)	2.791E-4	2.522E-4	2.814E-4	2.815E-4	3.683E-4

Delta [lih_DB5]

	0krad(Si)	41krad(Si)	78krad(Si)	114krad(Si)	150krad(Si)
N° 1 (Ref)	---	-4.564E-5	-3.463E-5	-3.970E-5	-7.532E-5
N° 2 (ON)	---	-6.223E-5	-2.543E-5	2.178E-6	1.606E-5
N° 3 (ON)	---	-6.066E-5	-2.631E-5	-2.941E-6	1.323E-5
N° 4 (ON)	---	-5.618E-5	-2.566E-5	-2.580E-6	2.246E-5
N° 5 (ON)	---	-6.257E-5	-2.343E-5	-1.187E-5	2.228E-5
N° 6 (ON)	---	-5.388E-5	-1.248E-5	9.468E-6	5.261E-5
N° 7 (OFF)	---	-6.737E-5	-4.194E-5	-3.834E-5	1.643E-6
N° 8 (OFF)	---	-1.463E-5	1.085E-5	1.775E-5	6.192E-5
N° 9 (OFF)	---	-1.912E-5	5.717E-6	8.650E-6	7.012E-5
N° 10 (OFF)	---	-2.414E-5	1.301E-6	9.669E-6	1.066E-4
N° 11 (OFF)	---	-2.682E-5	2.290E-6	2.471E-6	8.923E-5
Average (ON)	---	-5.911E-5	-2.266E-5	-1.148E-6	2.533E-5
s (ON)	---	3.874E-6	5.795E-6	7.809E-6	1.576E-5
Average+3s (ON)	---	-4.748E-5	-5.278E-6	2.228E-5	7.262E-5
Average-3s (ON)	---	-7.073E-5	-4.005E-5	-2.458E-5	-2.196E-5
Average (OFF)	---	-3.042E-5	-4.356E-6	3.900E-8	6.591E-5
s (OFF)	---	2.118E-5	2.134E-5	2.213E-5	3.989E-5
Average+3s (OFF)	---	3.313E-5	5.966E-5	6.644E-5	1.856E-4
Average-3s (OFF)	---	-9.396E-5	-6.838E-5	-6.636E-5	-5.377E-5

34. lih_DB6

Ta= 25°C ; Vcc = 5V ; Vin = 5V

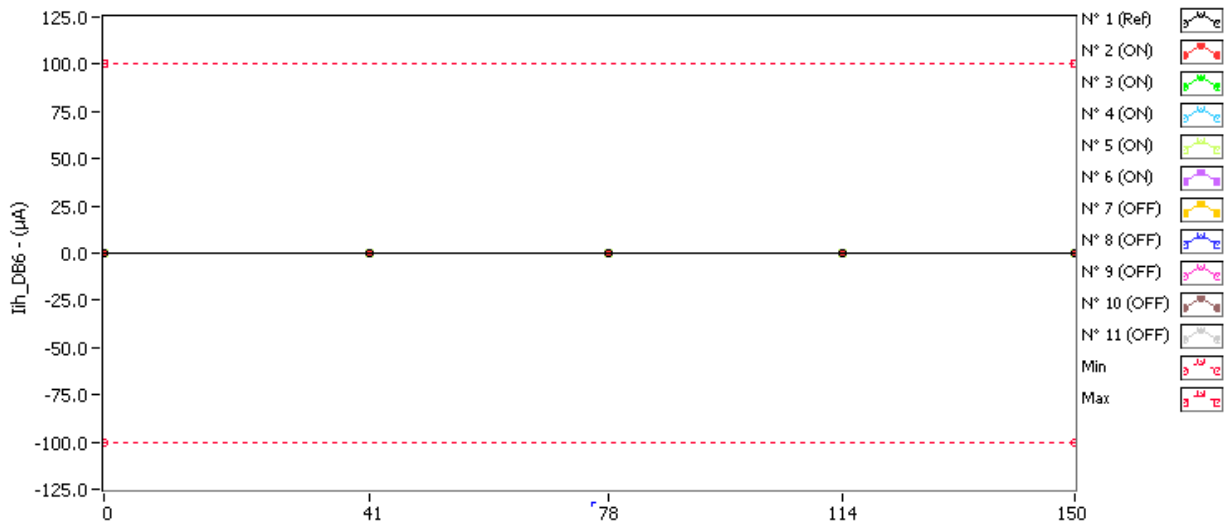

lih_DB6 . (µA) Min = -100.0 Max = 100.0

	0krad(Si)	41krad(Si)	78krad(Si)	114krad(Si)	150krad(Si)
N° 1 (Ref)	3.733E-4	3.261E-4	3.375E-4	3.325E-4	2.999E-4
N° 2 (ON)	3.515E-4	2.867E-4	3.248E-4	3.434E-4	3.520E-4
N° 3 (ON)	3.502E-4	2.881E-4	3.288E-4	3.434E-4	3.629E-4
N° 4 (ON)	3.561E-4	3.047E-4	3.349E-4	3.517E-4	3.526E-4
N° 5 (ON)	3.631E-4	3.064E-4	3.419E-4	3.570E-4	3.826E-4
N° 6 (ON)	3.333E-4	2.905E-4	3.273E-4	3.407E-4	3.716E-4
N° 7 (OFF)	3.510E-4	2.787E-4	2.992E-4	3.046E-4	3.402E-4
N° 8 (OFF)	2.895E-4	2.703E-4	2.948E-4	3.012E-4	3.455E-4
N° 9 (OFF)	2.967E-4	2.757E-4	3.017E-4	3.045E-4	3.600E-4
N° 10 (OFF)	3.196E-4	2.902E-4	3.175E-4	3.227E-4	4.249E-4
N° 11 (OFF)	3.130E-4	2.827E-4	3.096E-4	3.126E-4	3.951E-4

Delta [lih_DB6]

	0krad(Si)	41krad(Si)	78krad(Si)	114krad(Si)	150krad(Si)
N° 1 (Ref)	---	-4.722E-5	-3.575E-5	-4.074E-5	-7.334E-5
N° 2 (ON)	---	-6.472E-5	-2.662E-5	-8.056E-6	5.810E-7
N° 3 (ON)	---	-6.211E-5	-2.137E-5	-6.766E-6	1.265E-5
N° 4 (ON)	---	-5.140E-5	-2.124E-5	-4.436E-6	-3.556E-6
N° 5 (ON)	---	-5.675E-5	-2.117E-5	-6.132E-6	1.952E-5
N° 6 (ON)	---	-4.283E-5	-5.967E-6	7.371E-6	3.831E-5
N° 7 (OFF)	---	-7.231E-5	-5.186E-5	-4.647E-5	-1.078E-5
N° 8 (OFF)	---	-1.919E-5	5.284E-6	1.175E-5	5.607E-5
N° 9 (OFF)	---	-2.105E-5	5.006E-6	7.781E-6	6.329E-5
N° 10 (OFF)	---	-2.933E-5	-2.091E-6	3.114E-6	1.054E-4
N° 11 (OFF)	---	-3.026E-5	-3.371E-6	-3.980E-7	8.217E-5
Average (ON)	---	-5.556E-5	-1.927E-5	-3.604E-6	1.350E-5
s (ON)	---	8.768E-6	7.792E-6	6.272E-6	1.666E-5
Average+3s (ON)	---	-2.926E-5	4.103E-6	1.521E-5	6.348E-5
Average-3s (ON)	---	-8.187E-5	-4.265E-5	-2.242E-5	-3.648E-5
Average (OFF)	---	-3.443E-5	-9.405E-6	-4.845E-6	5.922E-5
s (OFF)	---	2.173E-5	2.406E-5	2.372E-5	4.354E-5
Average+3s (OFF)	---	3.077E-5	6.277E-5	6.631E-5	1.898E-4
Average-3s (OFF)	---	-9.963E-5	-8.158E-5	-7.600E-5	-7.139E-5

35. lih_DB7

Ta= 25°C ; Vcc = 5V ; Vin = 5V

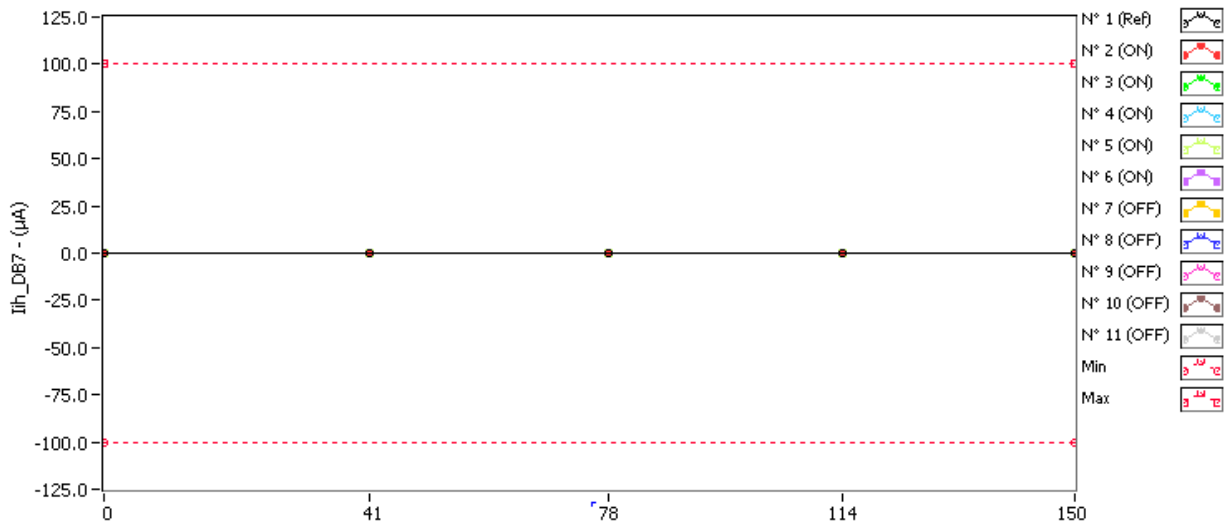

lih_DB7 . (µA) Min = -100.0 Max = 100.0

	0krad(Si)	41krad(Si)	78krad(Si)	114krad(Si)	150krad(Si)
N° 1 (Ref)	4.130E-4	3.669E-4	3.757E-4	3.713E-4	3.350E-4
N° 2 (ON)	3.896E-4	3.096E-4	3.437E-4	3.647E-4	3.757E-4
N° 3 (ON)	3.874E-4	3.134E-4	3.419E-4	3.616E-4	3.740E-4
N° 4 (ON)	3.966E-4	3.028E-4	3.523E-4	3.678E-4	4.127E-4
N° 5 (ON)	4.017E-4	3.273E-4	3.605E-4	3.708E-4	4.037E-4
N° 6 (ON)	3.644E-4	3.035E-4	3.356E-4	3.552E-4	3.713E-4
N° 7 (OFF)	3.879E-4	3.057E-4	3.279E-4	3.266E-4	3.236E-4
N° 8 (OFF)	3.219E-4	2.998E-4	3.236E-4	3.264E-4	3.667E-4
N° 9 (OFF)	3.309E-4	3.061E-4	3.303E-4	3.321E-4	3.821E-4
N° 10 (OFF)	3.585E-4	3.272E-4	3.508E-4	3.476E-4	4.510E-4
N° 11 (OFF)	3.478E-4	3.092E-4	3.380E-4	3.396E-4	4.181E-4

Delta [lih_DB7]

	0krad(Si)	41krad(Si)	78krad(Si)	114krad(Si)	150krad(Si)
N° 1 (Ref)	---	-4.608E-5	-3.727E-5	-4.175E-5	-7.805E-5
N° 2 (ON)	---	-8.001E-5	-4.593E-5	-2.490E-5	-1.390E-5
N° 3 (ON)	---	-7.401E-5	-4.548E-5	-2.578E-5	-1.343E-5
N° 4 (ON)	---	-9.373E-5	-4.424E-5	-2.872E-5	1.613E-5
N° 5 (ON)	---	-7.441E-5	-4.126E-5	-3.088E-5	1.970E-6
N° 6 (ON)	---	-6.086E-5	-2.880E-5	-9.167E-6	6.846E-6
N° 7 (OFF)	---	-8.213E-5	-5.994E-5	-6.125E-5	-6.422E-5
N° 8 (OFF)	---	-2.216E-5	1.659E-6	4.461E-6	4.479E-5
N° 9 (OFF)	---	-2.483E-5	-6.420E-7	1.203E-6	5.117E-5
N° 10 (OFF)	---	-3.132E-5	-7.700E-6	-1.091E-5	9.249E-5
N° 11 (OFF)	---	-3.868E-5	-9.805E-6	-8.289E-6	7.027E-5
Average (ON)	---	-7.660E-5	-4.114E-5	-2.389E-5	-4.774E-7
s (ON)	---	1.188E-5	7.134E-6	8.568E-6	1.307E-5
Average+3s (ON)	---	-4.097E-5	-1.974E-5	1.813E-6	3.873E-5
Average-3s (ON)	---	-1.122E-4	-6.254E-5	-4.959E-5	-3.969E-5
Average (OFF)	---	-3.983E-5	-1.529E-5	-1.496E-5	3.890E-5
s (OFF)	---	2.450E-5	2.541E-5	2.666E-5	6.057E-5
Average+3s (OFF)	---	3.366E-5	6.095E-5	6.501E-5	2.206E-4
Average-3s (OFF)	---	-1.133E-4	-9.153E-5	-9.493E-5	-1.428E-4

36. lih_CS

Ta= 25°C ; Vcc = 5V ; Vin = 5V

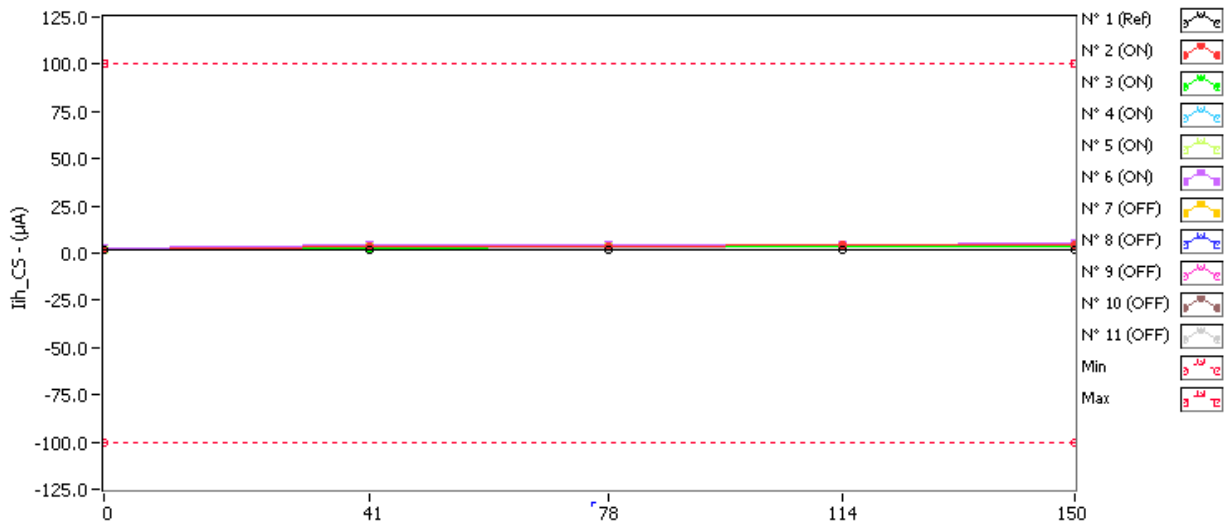

lih_CS . (µA) Min = -100.0 Max = 100.0

	0krad(Si)	41krad(Si)	78krad(Si)	114krad(Si)	150krad(Si)
N° 1 (Ref)	1.999	2.002	2.003	2.001	2.004
N° 2 (ON)	1.960	3.420	3.800	4.009	4.167
N° 3 (ON)	1.793	2.883	3.119	3.271	3.401
N° 4 (ON)	1.925	3.371	3.750	3.947	4.090
N° 5 (ON)	2.053	3.219	3.470	3.602	3.790
N° 6 (ON)	2.493	4.134	4.515	4.729	4.891
N° 7 (OFF)	2.012	3.026	3.310	3.486	3.636
N° 8 (OFF)	1.978	2.967	3.230	3.391	3.526
N° 9 (OFF)	1.963	2.919	3.166	3.328	3.455
N° 10 (OFF)	2.076	3.042	3.320	3.496	3.655
N° 11 (OFF)	1.835	2.742	2.991	3.139	3.273

Delta [lih_CS]

	0krad(Si)	41krad(Si)	78krad(Si)	114krad(Si)	150krad(Si)
N° 1 (Ref)	---	2.940E-3	3.150E-3	2.040E-3	4.990E-3
N° 2 (ON)	---	1.460E+0	1.840E+0	2.049E+0	2.207E+0
N° 3 (ON)	---	1.090E+0	1.326E+0	1.478E+0	1.608E+0
N° 4 (ON)	---	1.447E+0	1.826E+0	2.022E+0	2.165E+0
N° 5 (ON)	---	1.166E+0	1.417E+0	1.549E+0	1.737E+0
N° 6 (ON)	---	1.641E+0	2.022E+0	2.236E+0	2.398E+0
N° 7 (OFF)	---	1.014E+0	1.299E+0	1.475E+0	1.624E+0
N° 8 (OFF)	---	9.887E-1	1.252E+0	1.413E+0	1.548E+0
N° 9 (OFF)	---	9.565E-1	1.203E+0	1.365E+0	1.492E+0
N° 10 (OFF)	---	9.660E-1	1.244E+0	1.420E+0	1.579E+0
N° 11 (OFF)	---	9.070E-1	1.156E+0	1.304E+0	1.438E+0
Average (ON)	---	1.361E+0	1.686E+0	1.867E+0	2.023E+0
s (ON)	---	2.275E-1	2.991E-1	3.338E-1	3.349E-1
Average+3s (ON)	---	2.043E+0	2.584E+0	2.868E+0	3.028E+0
Average-3s (ON)	---	6.785E-1	7.889E-1	8.656E-1	1.018E+0
Average (OFF)	---	9.664E-1	1.231E+0	1.395E+0	1.536E+0
s (OFF)	---	3.994E-2	5.384E-2	6.410E-2	7.303E-2
Average+3s (OFF)	---	1.086E+0	1.392E+0	1.588E+0	1.755E+0
Average-3s (OFF)	---	8.466E-1	1.069E+0	1.203E+0	1.317E+0

37. lih_CE

Ta= 25°C ; Vcc = 5V ; Vin = 5V

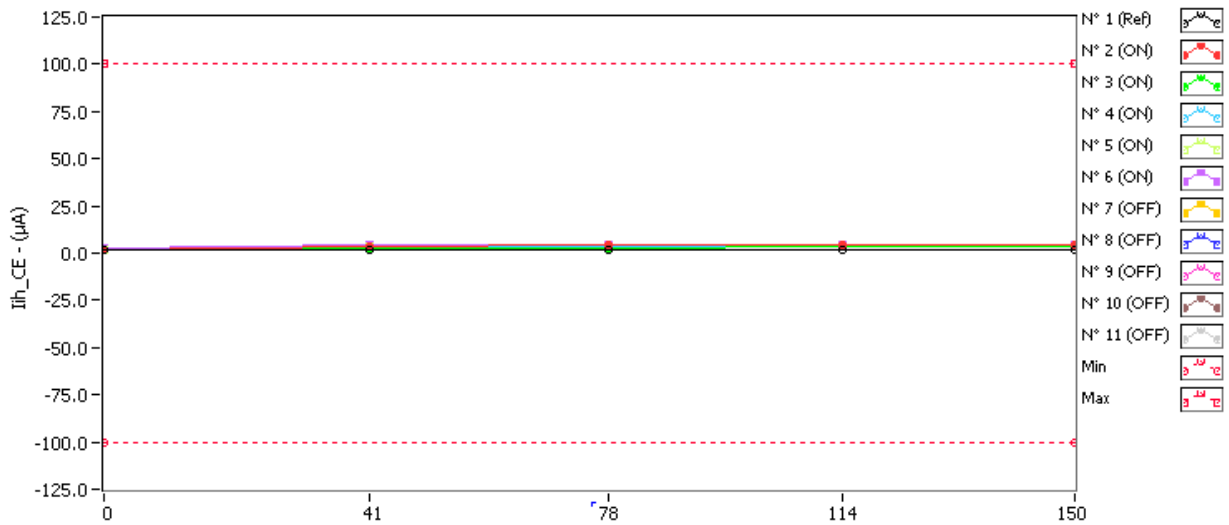

lih_CE . (µA) Min = -100.0 Max = 100.0

	0krad(Si)	41krad(Si)	78krad(Si)	114krad(Si)	150krad(Si)
N° 1 (Ref)	2.021	2.024	2.025	2.025	2.027
N° 2 (ON)	2.184	3.612	3.988	4.169	4.281
N° 3 (ON)	1.805	2.868	3.055	3.211	3.307
N° 4 (ON)	1.939	3.337	3.702	3.876	3.983
N° 5 (ON)	2.080	3.227	3.461	3.576	3.676
N° 6 (ON)	2.542	4.180	4.514	4.478	4.796
N° 7 (OFF)	2.035	3.033	3.305	3.458	3.579
N° 8 (OFF)	1.994	2.955	3.205	3.361	3.477
N° 9 (OFF)	1.927	2.844	3.087	3.232	3.353
N° 10 (OFF)	2.102	3.031	3.295	3.450	3.580
N° 11 (OFF)	1.853	2.727	2.960	3.092	3.216

Delta [lih_CE]

	0krad(Si)	41krad(Si)	78krad(Si)	114krad(Si)	150krad(Si)
N° 1 (Ref)	---	3.310E-3	4.410E-3	4.020E-3	6.340E-3
N° 2 (ON)	---	1.429E+0	1.805E+0	1.985E+0	2.097E+0
N° 3 (ON)	---	1.063E+0	1.250E+0	1.406E+0	1.502E+0
N° 4 (ON)	---	1.398E+0	1.763E+0	1.937E+0	2.044E+0
N° 5 (ON)	---	1.147E+0	1.381E+0	1.496E+0	1.596E+0
N° 6 (ON)	---	1.638E+0	1.971E+0	1.935E+0	2.253E+0
N° 7 (OFF)	---	9.985E-1	1.271E+0	1.423E+0	1.545E+0
N° 8 (OFF)	---	9.608E-1	1.211E+0	1.367E+0	1.483E+0
N° 9 (OFF)	---	9.177E-1	1.160E+0	1.305E+0	1.427E+0
N° 10 (OFF)	---	9.295E-1	1.193E+0	1.348E+0	1.479E+0
N° 11 (OFF)	---	8.740E-1	1.106E+0	1.239E+0	1.363E+0
Average (ON)	---	1.335E+0	1.634E+0	1.752E+0	1.898E+0
s (ON)	---	2.313E-1	3.046E-1	2.773E-1	3.301E-1
Average+3s (ON)	---	2.029E+0	2.548E+0	2.584E+0	2.889E+0
Average-3s (ON)	---	6.408E-1	7.203E-1	9.202E-1	9.083E-1
Average (OFF)	---	9.361E-1	1.188E+0	1.337E+0	1.459E+0
s (OFF)	---	4.678E-2	6.091E-2	6.905E-2	6.811E-2
Average+3s (OFF)	---	1.076E+0	1.371E+0	1.544E+0	1.664E+0
Average-3s (OFF)	---	7.958E-1	1.006E+0	1.129E+0	1.255E+0

38. IIL_DB0

Ta= 25°C ; Vcc = 5V ; Vin = 0V

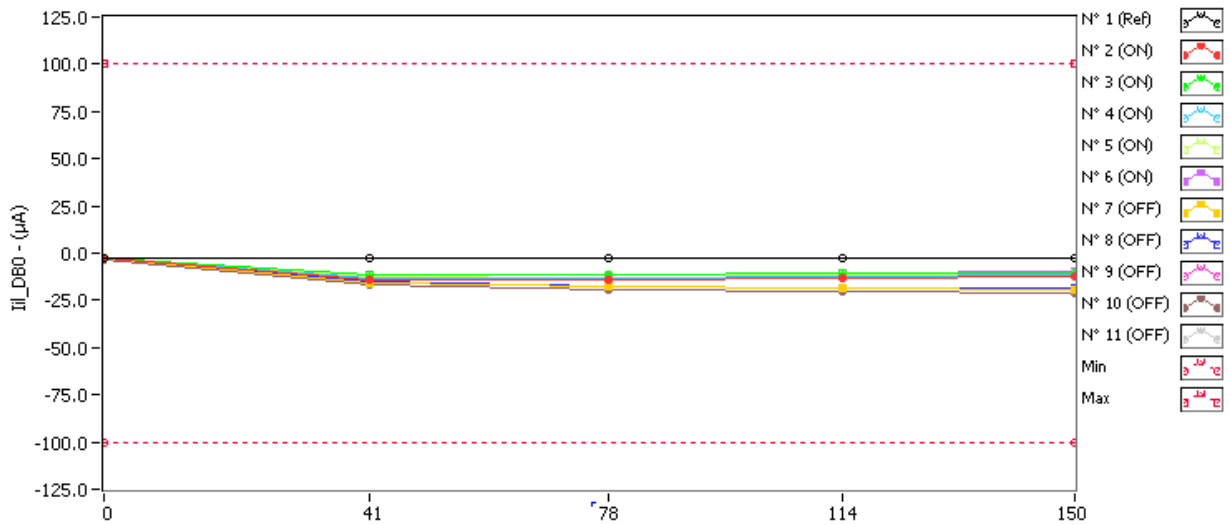

IIL_DB0 . (µA) Min = -100.0 Max = 100.0

	0krad(Si)	41krad(Si)	78krad(Si)	114krad(Si)	150krad(Si)
N° 1 (Ref)	-3.017	-3.002	-2.995	-2.997	-2.990
N° 2 (ON)	-2.777	-13.711	-13.712	-12.853	-12.032
N° 3 (ON)	-2.935	-11.485	-11.524	-10.841	-10.215
N° 4 (ON)	-2.709	-13.152	-13.037	-12.192	-11.427
N° 5 (ON)	-3.008	-11.892	-11.864	-11.088	-10.419
N° 6 (ON)	-2.461	-11.775	-11.359	-10.469	-9.704
N° 7 (OFF)	-2.759	-15.642	-17.892	-18.643	-18.953
N° 8 (OFF)	-2.665	-15.214	-17.535	-18.280	-18.619
N° 9 (OFF)	-2.680	-15.082	-17.529	-18.353	-18.685
N° 10 (OFF)	-3.244	-16.860	-19.651	-20.577	-20.930
N° 11 (OFF)	-2.723	-15.626	-17.965	-18.726	-18.827

Delta [IIL_DB0]

	0krad(Si)	41krad(Si)	78krad(Si)	114krad(Si)	150krad(Si)
N° 1 (Ref)	---	1.478E-2	2.133E-2	1.936E-2	2.640E-2
N° 2 (ON)	---	-1.093E+1	-1.094E+1	-1.008E+1	-9.254E+0
N° 3 (ON)	---	-8.550E+0	-8.589E+0	-7.906E+0	-7.280E+0
N° 4 (ON)	---	-1.044E+1	-1.033E+1	-9.483E+0	-8.717E+0
N° 5 (ON)	---	-8.883E+0	-8.856E+0	-8.079E+0	-7.411E+0
N° 6 (ON)	---	-9.315E+0	-8.899E+0	-8.008E+0	-7.243E+0
N° 7 (OFF)	---	-1.288E+1	-1.513E+1	-1.588E+1	-1.619E+1
N° 8 (OFF)	---	-1.255E+1	-1.487E+1	-1.562E+1	-1.595E+1
N° 9 (OFF)	---	-1.240E+1	-1.485E+1	-1.567E+1	-1.600E+1
N° 10 (OFF)	---	-1.362E+1	-1.641E+1	-1.733E+1	-1.769E+1
N° 11 (OFF)	---	-1.290E+1	-1.524E+1	-1.600E+1	-1.610E+1
Average (ON)	---	-9.625E+0	-9.521E+0	-8.710E+0	-7.981E+0
s (ON)	---	1.023E+0	1.043E+0	9.999E-1	9.387E-1
Average+3s (ON)	---	-6.557E+0	-6.393E+0	-5.710E+0	-5.165E+0
Average-3s (ON)	---	-1.269E+1	-1.265E+1	-1.171E+1	-1.080E+1
Average (OFF)	---	-1.287E+1	-1.530E+1	-1.610E+1	-1.639E+1
s (OFF)	---	4.691E-1	6.416E-1	7.059E-1	7.311E-1
Average+3s (OFF)	---	-1.146E+1	-1.338E+1	-1.398E+1	-1.420E+1
Average-3s (OFF)	---	-1.428E+1	-1.723E+1	-1.822E+1	-1.858E+1

39. IIL_DB1

Ta= 25°C ; Vcc = 5V ; Vin = 0V

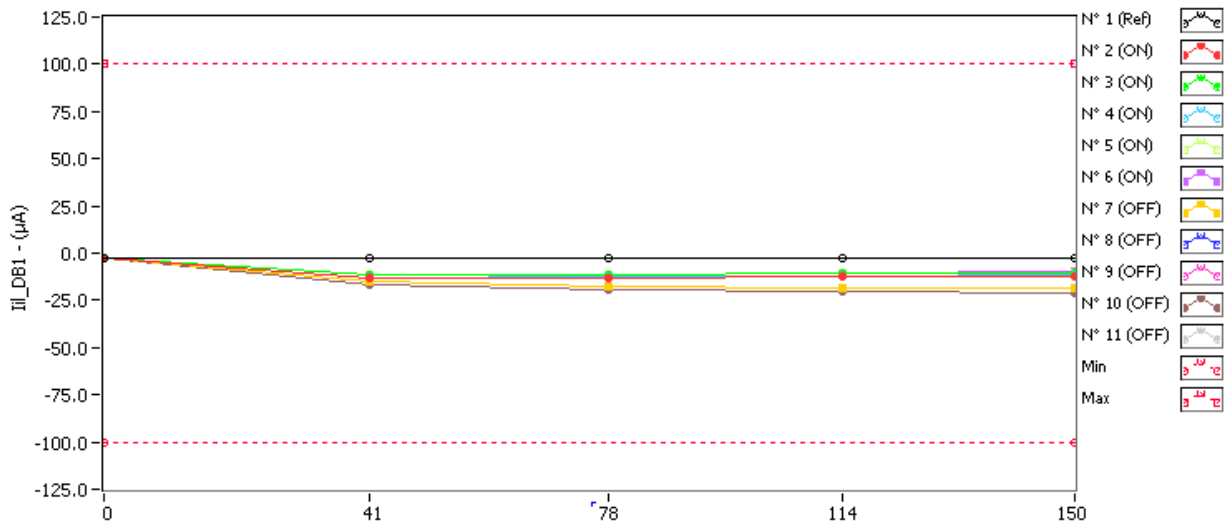

IIL_DB1 . (µA) Min = -100.0 Max = 100.0

	0krad(Si)	41krad(Si)	78krad(Si)	114krad(Si)	150krad(Si)
N° 1 (Ref)	-2.802	-2.788	-2.781	-2.784	-2.776
N° 2 (ON)	-2.743	-13.581	-13.550	-12.716	-11.915
N° 3 (ON)	-2.751	-11.355	-11.388	-10.745	-10.140
N° 4 (ON)	-2.564	-12.840	-12.734	-11.915	-11.190
N° 5 (ON)	-2.961	-11.698	-11.688	-10.941	-10.323
N° 6 (ON)	-2.421	-11.578	-11.213	-10.382	-9.656
N° 7 (OFF)	-2.760	-15.080	-17.385	-18.184	-18.534
N° 8 (OFF)	-2.631	-15.043	-17.337	-18.073	-18.403
N° 9 (OFF)	-2.585	-14.994	-17.431	-18.226	-18.545
N° 10 (OFF)	-3.019	-16.630	-19.388	-20.322	-20.689
N° 11 (OFF)	-2.727	-15.195	-17.569	-18.355	-18.471

Delta [IIL_DB1]

	0krad(Si)	41krad(Si)	78krad(Si)	114krad(Si)	150krad(Si)
N° 1 (Ref)	---	1.409E-2	2.097E-2	1.808E-2	2.644E-2
N° 2 (ON)	---	-1.084E+1	-1.081E+1	-9.973E+0	-9.172E+0
N° 3 (ON)	---	-8.604E+0	-8.637E+0	-7.994E+0	-7.389E+0
N° 4 (ON)	---	-1.028E+1	-1.017E+1	-9.352E+0	-8.627E+0
N° 5 (ON)	---	-8.738E+0	-8.727E+0	-7.981E+0	-7.362E+0
N° 6 (ON)	---	-9.157E+0	-8.793E+0	-7.962E+0	-7.236E+0
N° 7 (OFF)	---	-1.232E+1	-1.462E+1	-1.542E+1	-1.577E+1
N° 8 (OFF)	---	-1.241E+1	-1.471E+1	-1.544E+1	-1.577E+1
N° 9 (OFF)	---	-1.241E+1	-1.485E+1	-1.564E+1	-1.596E+1
N° 10 (OFF)	---	-1.361E+1	-1.637E+1	-1.730E+1	-1.767E+1
N° 11 (OFF)	---	-1.247E+1	-1.484E+1	-1.563E+1	-1.574E+1
Average (ON)	---	-9.523E+0	-9.427E+0	-8.652E+0	-7.957E+0
s (ON)	---	9.861E-1	9.962E-1	9.479E-1	8.833E-1
Average+3s (ON)	---	-6.564E+0	-6.438E+0	-5.808E+0	-5.307E+0
Average-3s (ON)	---	-1.248E+1	-1.242E+1	-1.150E+1	-1.061E+1
Average (OFF)	---	-1.264E+1	-1.508E+1	-1.589E+1	-1.618E+1
s (OFF)	---	5.428E-1	7.281E-1	7.975E-1	8.349E-1
Average+3s (OFF)	---	-1.102E+1	-1.289E+1	-1.350E+1	-1.368E+1
Average-3s (OFF)	---	-1.427E+1	-1.726E+1	-1.828E+1	-1.869E+1

40. IIL_DB2

Ta= 25°C ; Vcc = 5V ; Vin = 0V

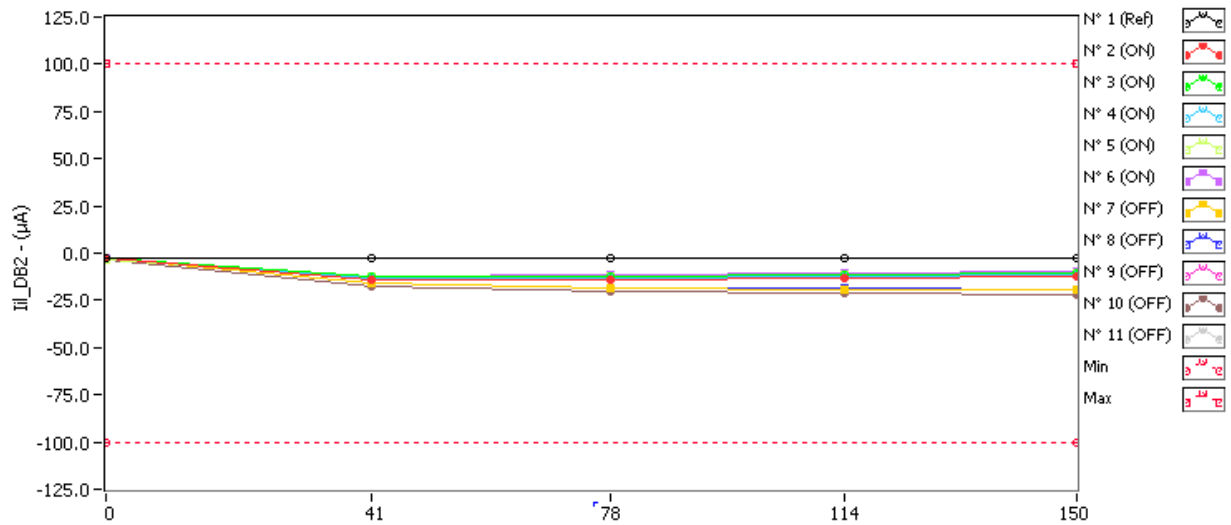

IIL_DB2 . (µA) Min = -100.0 Max = 100.0

	0krad(Si)	41krad(Si)	78krad(Si)	114krad(Si)	150krad(Si)
N° 1 (Ref)	-3.015	-2.999	-2.991	-2.994	-2.984
N° 2 (ON)	-2.946	-14.293	-14.306	-13.424	-12.555
N° 3 (ON)	-2.907	-11.912	-11.971	-11.254	-10.585
N° 4 (ON)	-2.666	-13.354	-13.422	-12.565	-11.770
N° 5 (ON)	-3.140	-12.282	-12.298	-11.513	-10.825
N° 6 (ON)	-2.559	-12.244	-11.779	-10.822	-9.992
N° 7 (OFF)	-2.968	-15.870	-18.290	-19.136	-19.491
N° 8 (OFF)	-2.644	-15.618	-18.096	-18.901	-19.268
N° 9 (OFF)	-2.718	-15.569	-18.179	-19.043	-19.392
N° 10 (OFF)	-3.299	-17.394	-20.337	-21.332	-21.715
N° 11 (OFF)	-2.847	-15.793	-18.352	-19.210	-19.366

Delta [IIL_DB2]

	0krad(Si)	41krad(Si)	78krad(Si)	114krad(Si)	150krad(Si)
N° 1 (Ref)	---	1.642E-2	2.403E-2	2.122E-2	3.088E-2
N° 2 (ON)	---	-1.135E+1	-1.136E+1	-1.048E+1	-9.609E+0
N° 3 (ON)	---	-9.005E+0	-9.063E+0	-8.347E+0	-7.678E+0
N° 4 (ON)	---	-1.069E+1	-1.076E+1	-9.898E+0	-9.104E+0
N° 5 (ON)	---	-9.143E+0	-9.159E+0	-8.374E+0	-7.685E+0
N° 6 (ON)	---	-9.685E+0	-9.219E+0	-8.262E+0	-7.433E+0
N° 7 (OFF)	---	-1.290E+1	-1.532E+1	-1.617E+1	-1.652E+1
N° 8 (OFF)	---	-1.297E+1	-1.545E+1	-1.626E+1	-1.662E+1
N° 9 (OFF)	---	-1.285E+1	-1.546E+1	-1.633E+1	-1.667E+1
N° 10 (OFF)	---	-1.409E+1	-1.704E+1	-1.803E+1	-1.842E+1
N° 11 (OFF)	---	-1.295E+1	-1.551E+1	-1.636E+1	-1.652E+1
Average (ON)	---	-9.973E+0	-9.912E+0	-9.072E+0	-8.302E+0
s (ON)	---	1.013E+0	1.070E+0	1.040E+0	9.843E-1
Average+3s (ON)	---	-6.933E+0	-6.702E+0	-5.951E+0	-5.349E+0
Average-3s (ON)	---	-1.301E+1	-1.312E+1	-1.219E+1	-1.125E+1
Average (OFF)	---	-1.315E+1	-1.576E+1	-1.663E+1	-1.695E+1
s (OFF)	---	5.282E-1	7.202E-1	7.881E-1	8.215E-1
Average+3s (OFF)	---	-1.157E+1	-1.360E+1	-1.426E+1	-1.449E+1
Average-3s (OFF)	---	-1.474E+1	-1.792E+1	-1.899E+1	-1.942E+1

41. IIL_DB3

Ta= 25°C ; Vcc = 5V ; Vin = 0V

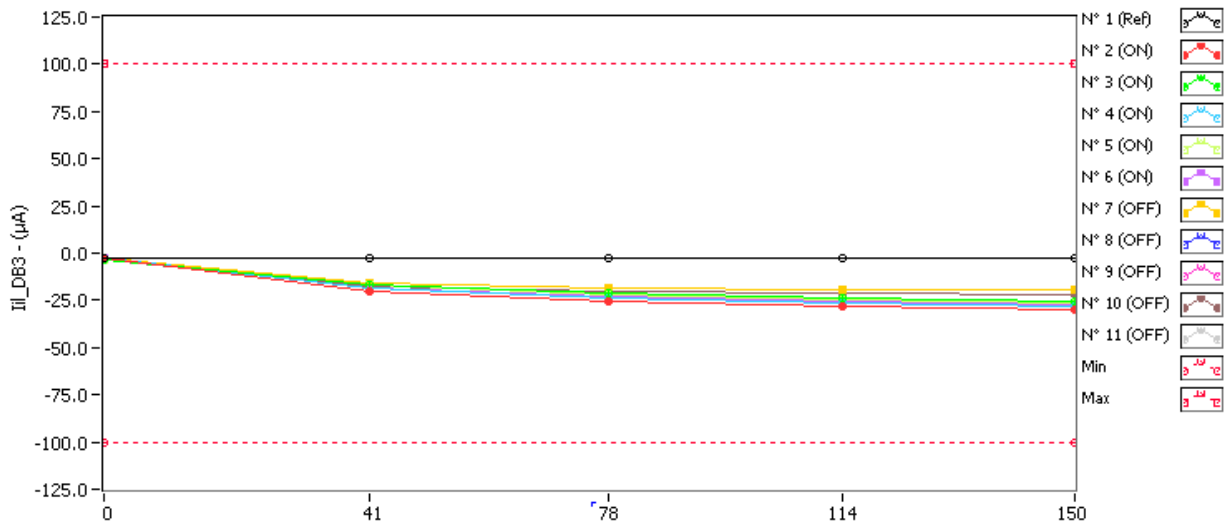

IIL_DB3 . (µA) Min = -100.0 Max = 100.0

	0krad(Si)	41krad(Si)	78krad(Si)	114krad(Si)	150krad(Si)
N° 1 (Ref)	-3.013	-2.996	-2.988	-2.992	-2.981
N° 2 (ON)	-3.049	-20.148	-25.233	-28.176	-30.104
N° 3 (ON)	-3.091	-16.409	-20.990	-23.517	-25.111
N° 4 (ON)	-2.998	-18.617	-23.558	-26.283	-28.094
N° 5 (ON)	-3.099	-17.044	-21.985	-24.672	-26.238
N° 6 (ON)	-2.638	-18.597	-23.297	-25.915	-27.518
N° 7 (OFF)	-2.902	-16.113	-18.602	-19.443	-19.788
N° 8 (OFF)	-2.682	-15.910	-18.399	-19.226	-19.585
N° 9 (OFF)	-2.819	-15.843	-18.413	-19.261	-19.595
N° 10 (OFF)	-3.312	-17.632	-20.539	-21.513	-21.901
N° 11 (OFF)	-2.856	-16.025	-18.549	-19.374	-19.498

Delta [IIL_DB3]

	0krad(Si)	41krad(Si)	78krad(Si)	114krad(Si)	150krad(Si)
N° 1 (Ref)	---	1.671E-2	2.472E-2	2.122E-2	3.167E-2
N° 2 (ON)	---	-1.710E+1	-2.218E+1	-2.513E+1	-2.706E+1
N° 3 (ON)	---	-1.332E+1	-1.790E+1	-2.043E+1	-2.202E+1
N° 4 (ON)	---	-1.562E+1	-2.056E+1	-2.328E+1	-2.510E+1
N° 5 (ON)	---	-1.394E+1	-1.889E+1	-2.157E+1	-2.314E+1
N° 6 (ON)	---	-1.596E+1	-2.066E+1	-2.328E+1	-2.488E+1
N° 7 (OFF)	---	-1.321E+1	-1.570E+1	-1.654E+1	-1.689E+1
N° 8 (OFF)	---	-1.323E+1	-1.572E+1	-1.654E+1	-1.690E+1
N° 9 (OFF)	---	-1.302E+1	-1.559E+1	-1.644E+1	-1.678E+1
N° 10 (OFF)	---	-1.432E+1	-1.723E+1	-1.820E+1	-1.859E+1
N° 11 (OFF)	---	-1.317E+1	-1.569E+1	-1.652E+1	-1.664E+1
Average (ON)	---	-1.519E+1	-2.004E+1	-2.274E+1	-2.444E+1
s (ON)	---	1.539E+0	1.671E+0	1.803E+0	1.937E+0
Average+3s (ON)	---	-1.057E+1	-1.503E+1	-1.733E+1	-1.863E+1
Average-3s (ON)	---	-1.980E+1	-2.505E+1	-2.815E+1	-3.025E+1
Average (OFF)	---	-1.339E+1	-1.599E+1	-1.685E+1	-1.716E+1
s (OFF)	---	5.257E-1	6.955E-1	7.571E-1	8.059E-1
Average+3s (OFF)	---	-1.181E+1	-1.390E+1	-1.458E+1	-1.474E+1
Average-3s (OFF)	---	-1.497E+1	-1.807E+1	-1.912E+1	-1.958E+1

42. Iil_DB4

Ta= 25°C ; Vcc = 5V ; Vin = 0V

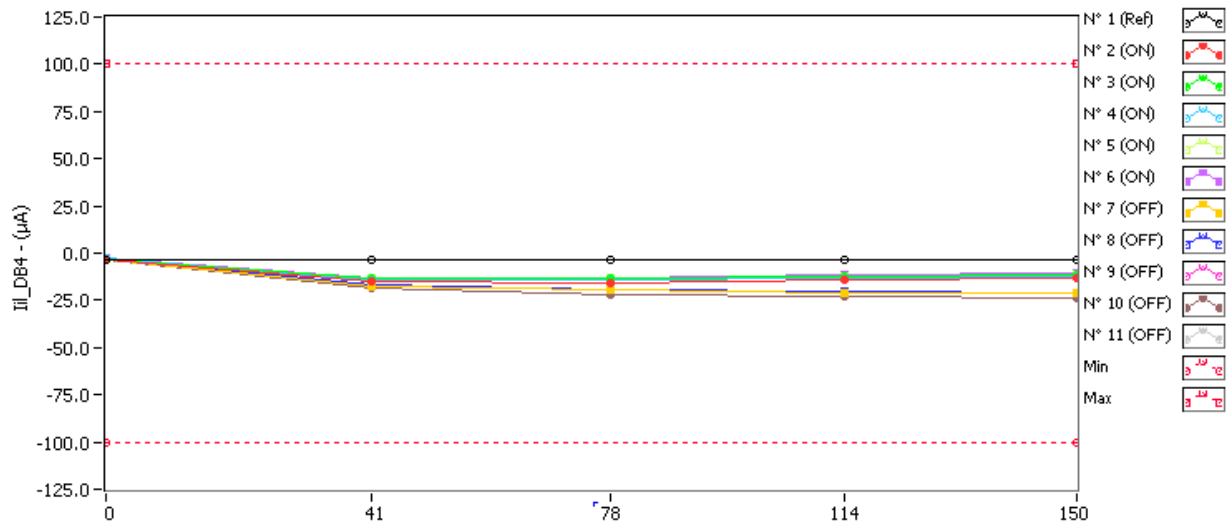

Iil_DB4 . (µA) Min = -100.0 Max = 100.0

	0krad(Si)	41krad(Si)	78krad(Si)	114krad(Si)	150krad(Si)
N° 1 (Ref)	-3.383	-3.363	-3.353	-3.358	-3.345
N° 2 (ON)	-3.296	-15.405	-15.418	-14.488	-13.587
N° 3 (ON)	-3.410	-12.798	-12.911	-12.165	-11.462
N° 4 (ON)	-3.058	-14.274	-14.361	-13.477	-12.650
N° 5 (ON)	-3.419	-13.269	-13.272	-12.394	-11.666
N° 6 (ON)	-2.923	-13.303	-12.826	-11.797	-10.901
N° 7 (OFF)	-3.125	-17.172	-19.804	-20.710	-21.090
N° 8 (OFF)	-2.918	-16.910	-19.599	-20.476	-20.877
N° 9 (OFF)	-3.053	-16.773	-19.605	-20.541	-20.931
N° 10 (OFF)	-3.634	-18.778	-22.025	-22.980	-23.393
N° 11 (OFF)	-3.125	-17.014	-19.801	-20.728	-20.879

Delta [Iil_DB4]

	0krad(Si)	41krad(Si)	78krad(Si)	114krad(Si)	150krad(Si)
N° 1 (Ref)	---	2.057E-2	3.043E-2	2.526E-2	3.862E-2
N° 2 (ON)	---	-1.211E+1	-1.212E+1	-1.119E+1	-1.029E+1
N° 3 (ON)	---	-9.387E+0	-9.500E+0	-8.754E+0	-8.051E+0
N° 4 (ON)	---	-1.122E+1	-1.130E+1	-1.042E+1	-9.592E+0
N° 5 (ON)	---	-9.850E+0	-9.853E+0	-8.975E+0	-8.247E+0
N° 6 (ON)	---	-1.038E+1	-9.903E+0	-8.875E+0	-7.979E+0
N° 7 (OFF)	---	-1.405E+1	-1.668E+1	-1.759E+1	-1.796E+1
N° 8 (OFF)	---	-1.399E+1	-1.668E+1	-1.756E+1	-1.796E+1
N° 9 (OFF)	---	-1.372E+1	-1.655E+1	-1.749E+1	-1.788E+1
N° 10 (OFF)	---	-1.514E+1	-1.839E+1	-1.935E+1	-1.976E+1
N° 11 (OFF)	---	-1.389E+1	-1.668E+1	-1.760E+1	-1.775E+1
Average (ON)	---	-1.059E+1	-1.054E+1	-9.643E+0	-8.832E+0
s (ON)	---	1.088E+0	1.123E+0	1.098E+0	1.047E+0
Average+3s (ON)	---	-7.325E+0	-7.168E+0	-6.348E+0	-5.691E+0
Average-3s (ON)	---	-1.385E+1	-1.390E+1	-1.294E+1	-1.197E+1
Average (OFF)	---	-1.416E+1	-1.700E+1	-1.792E+1	-1.826E+1
s (OFF)	---	5.650E-1	7.818E-1	8.007E-1	8.405E-1
Average+3s (OFF)	---	-1.246E+1	-1.465E+1	-1.551E+1	-1.574E+1
Average-3s (OFF)	---	-1.585E+1	-1.934E+1	-2.032E+1	-2.078E+1

43. IIL_DB5

Ta= 25°C ; Vcc = 5V ; Vin = 0V

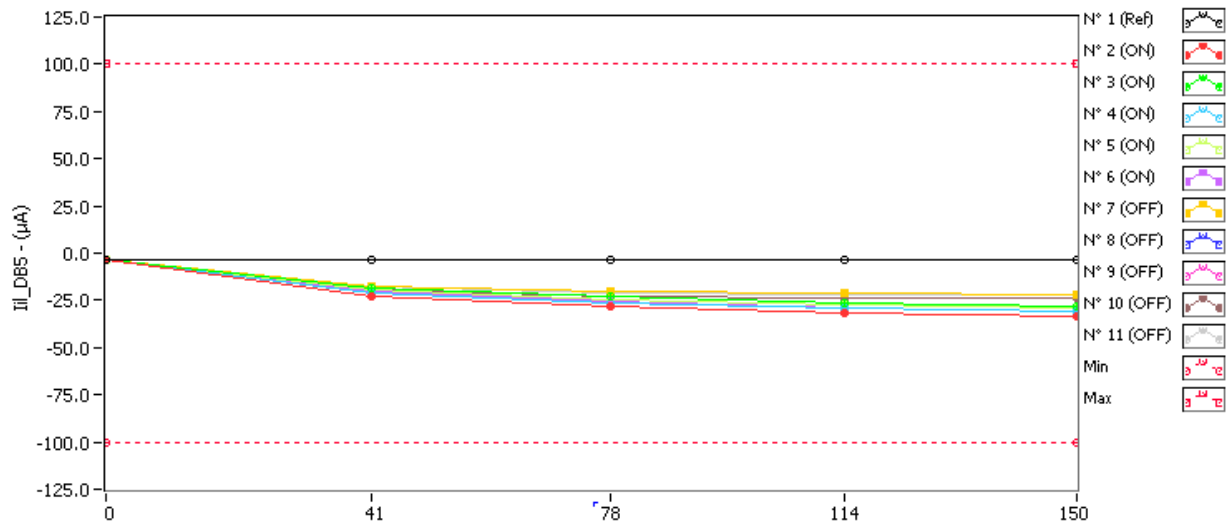

IIL_DB5 . (µA) Min = -100.0 Max = 100.0

	0krad(Si)	41krad(Si)	78krad(Si)	114krad(Si)	150krad(Si)
N° 1 (Ref)	-3.479	-3.455	-3.444	-3.450	-3.436
N° 2 (ON)	-3.467	-22.561	-28.144	-31.344	-33.453
N° 3 (ON)	-3.625	-18.228	-23.280	-26.060	-27.827
N° 4 (ON)	-3.240	-20.757	-26.143	-29.081	-31.031
N° 5 (ON)	-3.642	-18.939	-24.366	-27.292	-29.002
N° 6 (ON)	-3.094	-20.574	-25.756	-28.615	-30.386
N° 7 (OFF)	-3.335	-17.867	-20.543	-21.470	-21.869
N° 8 (OFF)	-3.221	-17.850	-20.547	-21.379	-21.781
N° 9 (OFF)	-3.293	-17.571	-20.430	-21.366	-21.749
N° 10 (OFF)	-3.747	-19.468	-22.694	-23.790	-24.192
N° 11 (OFF)	-3.349	-17.954	-20.738	-21.623	-21.724

Delta [IIL_DB5]

	0krad(Si)	41krad(Si)	78krad(Si)	114krad(Si)	150krad(Si)
N° 1 (Ref)	---	2.365E-2	3.528E-2	2.880E-2	4.320E-2
N° 2 (ON)	---	-1.909E+1	-2.468E+1	-2.788E+1	-2.999E+1
N° 3 (ON)	---	-1.460E+1	-1.965E+1	-2.244E+1	-2.420E+1
N° 4 (ON)	---	-1.752E+1	-2.290E+1	-2.584E+1	-2.779E+1
N° 5 (ON)	---	-1.530E+1	-2.072E+1	-2.365E+1	-2.536E+1
N° 6 (ON)	---	-1.748E+1	-2.266E+1	-2.552E+1	-2.729E+1
N° 7 (OFF)	---	-1.453E+1	-1.721E+1	-1.813E+1	-1.853E+1
N° 8 (OFF)	---	-1.463E+1	-1.733E+1	-1.816E+1	-1.856E+1
N° 9 (OFF)	---	-1.428E+1	-1.714E+1	-1.807E+1	-1.846E+1
N° 10 (OFF)	---	-1.572E+1	-1.895E+1	-2.004E+1	-2.045E+1
N° 11 (OFF)	---	-1.460E+1	-1.739E+1	-1.827E+1	-1.838E+1
Average (ON)	---	-1.680E+1	-2.212E+1	-2.506E+1	-2.693E+1
s (ON)	---	1.825E+0	1.967E+0	2.100E+0	2.243E+0
Average+3s (ON)	---	-1.132E+1	-1.622E+1	-1.877E+1	-2.020E+1
Average-3s (ON)	---	-2.227E+1	-2.802E+1	-3.136E+1	-3.365E+1
Average (OFF)	---	-1.475E+1	-1.760E+1	-1.854E+1	-1.887E+1
s (OFF)	---	5.590E-1	7.586E-1	8.452E-1	8.813E-1
Average+3s (OFF)	---	-1.308E+1	-1.533E+1	-1.600E+1	-1.623E+1
Average-3s (OFF)	---	-1.643E+1	-1.988E+1	-2.107E+1	-2.152E+1

44. IIL_DB6

Ta= 25°C ; Vcc = 5V ; Vin = 0V

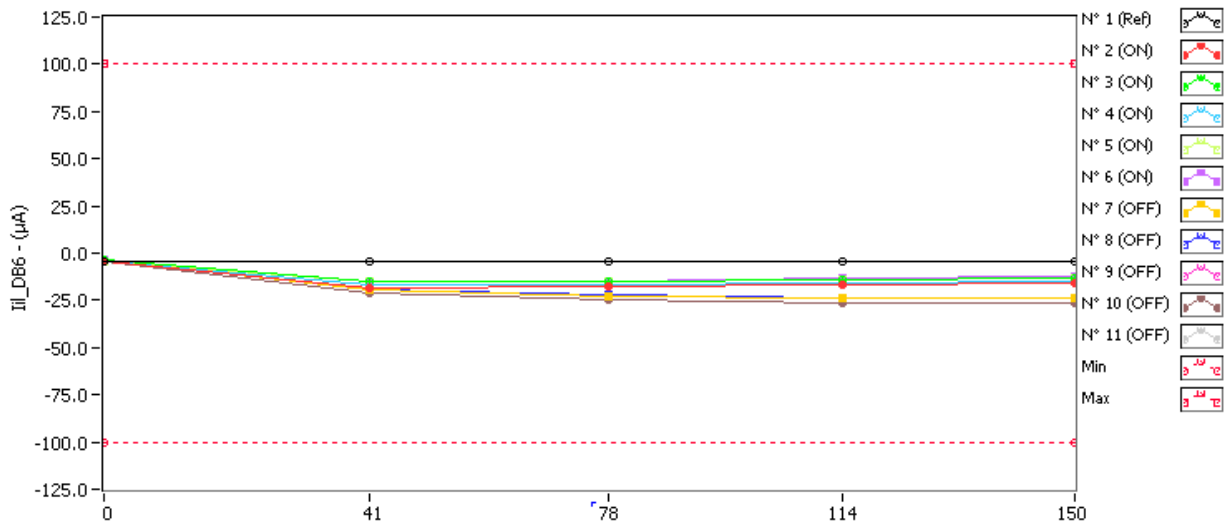

IIL_DB6 . (µA) Min = -100.0 Max = 100.0

	0krad(Si)	41krad(Si)	78krad(Si)	114krad(Si)	150krad(Si)
N° 1 (Ref)	-4.104	-4.069	-4.054	-4.063	-4.042
N° 2 (ON)	-4.252	-18.074	-17.925	-16.798	-15.701
N° 3 (ON)	-3.949	-14.733	-14.844	-13.984	-13.179
N° 4 (ON)	-3.966	-16.654	-16.712	-15.685	-14.735
N° 5 (ON)	-4.330	-15.259	-15.216	-14.214	-13.371
N° 6 (ON)	-3.372	-15.142	-14.555	-13.373	-12.416
N° 7 (OFF)	-3.951	-19.668	-22.632	-23.650	-24.110
N° 8 (OFF)	-3.510	-19.377	-22.393	-23.401	-23.832
N° 9 (OFF)	-3.889	-19.060	-22.256	-23.346	-23.802
N° 10 (OFF)	-4.335	-21.327	-24.963	-26.174	-26.672
N° 11 (OFF)	-3.730	-19.507	-22.654	-23.693	-23.864

Delta [IIL_DB6]

	0krad(Si)	41krad(Si)	78krad(Si)	114krad(Si)	150krad(Si)
N° 1 (Ref)	---	3.461E-2	4.991E-2	4.117E-2	6.136E-2
N° 2 (ON)	---	-1.382E+1	-1.367E+1	-1.255E+1	-1.145E+1
N° 3 (ON)	---	-1.078E+1	-1.090E+1	-1.003E+1	-9.230E+0
N° 4 (ON)	---	-1.269E+1	-1.275E+1	-1.172E+1	-1.077E+1
N° 5 (ON)	---	-1.093E+1	-1.089E+1	-9.883E+0	-9.041E+0
N° 6 (ON)	---	-1.177E+1	-1.118E+1	-1.000E+1	-9.044E+0
N° 7 (OFF)	---	-1.572E+1	-1.868E+1	-1.970E+1	-2.016E+1
N° 8 (OFF)	---	-1.587E+1	-1.888E+1	-1.989E+1	-2.032E+1
N° 9 (OFF)	---	-1.517E+1	-1.837E+1	-1.946E+1	-1.991E+1
N° 10 (OFF)	---	-1.699E+1	-2.063E+1	-2.184E+1	-2.234E+1
N° 11 (OFF)	---	-1.578E+1	-1.892E+1	-1.996E+1	-2.013E+1
Average (ON)	---	-1.200E+1	-1.188E+1	-1.084E+1	-9.906E+0
s (ON)	---	1.272E+0	1.266E+0	1.219E+0	1.126E+0
Average+3s (ON)	---	-8.183E+0	-8.079E+0	-7.178E+0	-6.528E+0
Average-3s (ON)	---	-1.581E+1	-1.567E+1	-1.450E+1	-1.329E+1
Average (OFF)	---	-1.590E+1	-1.910E+1	-2.017E+1	-2.057E+1
s (OFF)	---	6.660E-1	8.843E-1	9.535E-1	9.967E-1
Average+3s (OFF)	---	-1.391E+1	-1.644E+1	-1.731E+1	-1.758E+1
Average-3s (OFF)	---	-1.790E+1	-2.175E+1	-2.303E+1	-2.356E+1

45. IIL_DB7

Ta= 25°C ; Vcc = 5V ; Vin = 0V

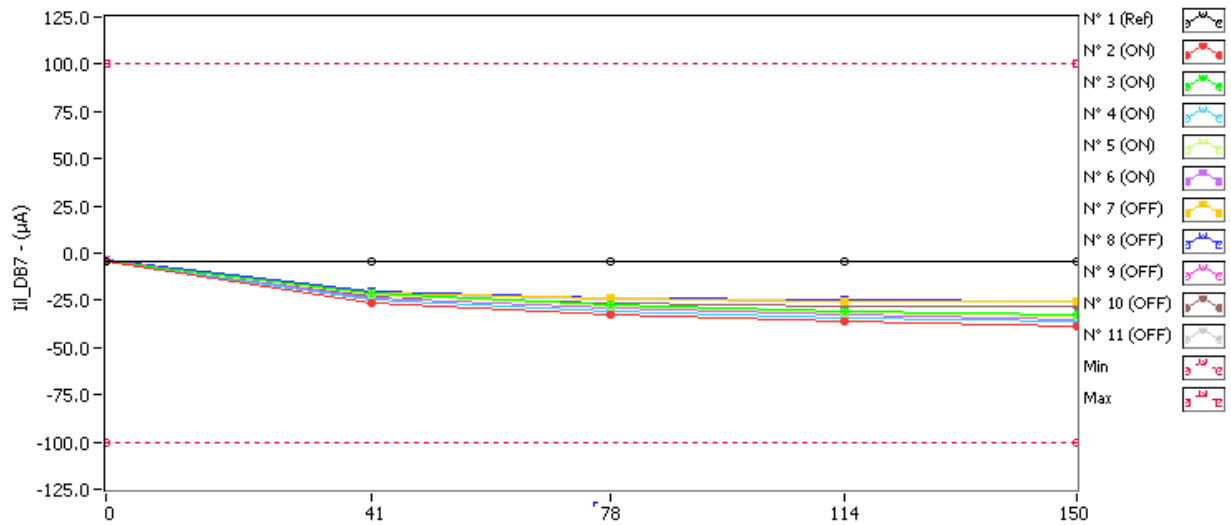

IIL_DB7 . (µA) Min = -100.0 Max = 100.0

	0krad(Si)	41krad(Si)	78krad(Si)	114krad(Si)	150krad(Si)
N° 1 (Ref)	-4.458	-4.418	-4.398	-4.409	-4.383
N° 2 (ON)	-4.634	-26.401	-32.802	-36.499	-38.994
N° 3 (ON)	-4.461	-21.360	-27.183	-30.411	-32.471
N° 4 (ON)	-4.412	-24.687	-30.828	-34.198	-36.450
N° 5 (ON)	-4.540	-21.939	-28.173	-31.520	-33.630
N° 6 (ON)	-3.895	-23.644	-29.435	-32.783	-34.936
N° 7 (OFF)	-4.165	-20.865	-24.020	-25.155	-25.705
N° 8 (OFF)	-3.871	-20.683	-23.794	-24.797	-25.354
N° 9 (OFF)	-4.240	-20.748	-23.915	-25.003	-25.494
N° 10 (OFF)	-4.656	-22.967	-26.694	-27.956	-28.592
N° 11 (OFF)	-4.099	-21.192	-24.320	-25.346	-25.642

Delta [IIL_DB7]

	0krad(Si)	41krad(Si)	78krad(Si)	114krad(Si)	150krad(Si)
N° 1 (Ref)	---	4.066E-2	6.074E-2	4.926E-2	7.538E-2
N° 2 (ON)	---	-2.177E+1	-2.817E+1	-3.187E+1	-3.436E+1
N° 3 (ON)	---	-1.690E+1	-2.272E+1	-2.595E+1	-2.801E+1
N° 4 (ON)	---	-2.027E+1	-2.642E+1	-2.979E+1	-3.204E+1
N° 5 (ON)	---	-1.740E+1	-2.363E+1	-2.698E+1	-2.909E+1
N° 6 (ON)	---	-1.975E+1	-2.554E+1	-2.889E+1	-3.104E+1
N° 7 (OFF)	---	-1.670E+1	-1.985E+1	-2.099E+1	-2.154E+1
N° 8 (OFF)	---	-1.681E+1	-1.992E+1	-2.093E+1	-2.148E+1
N° 9 (OFF)	---	-1.651E+1	-1.967E+1	-2.076E+1	-2.125E+1
N° 10 (OFF)	---	-1.831E+1	-2.204E+1	-2.330E+1	-2.394E+1
N° 11 (OFF)	---	-1.709E+1	-2.022E+1	-2.125E+1	-2.154E+1
Average (ON)	---	-1.922E+1	-2.530E+1	-2.869E+1	-3.091E+1
s (ON)	---	2.036E+0	2.177E+0	2.332E+0	2.496E+0
Average+3s (ON)	---	-1.311E+1	-1.877E+1	-2.170E+1	-2.342E+1
Average-3s (ON)	---	-2.533E+1	-3.183E+1	-3.569E+1	-3.840E+1
Average (OFF)	---	-1.708E+1	-2.034E+1	-2.145E+1	-2.195E+1
s (OFF)	---	7.174E-1	9.683E-1	1.051E+0	1.116E+0
Average+3s (OFF)	---	-1.493E+1	-1.744E+1	-1.829E+1	-1.860E+1
Average-3s (OFF)	---	-1.924E+1	-2.325E+1	-2.460E+1	-2.530E+1

46. IIL_CS

Ta= 25°C ; Vcc = 5V ; Vin = 0V

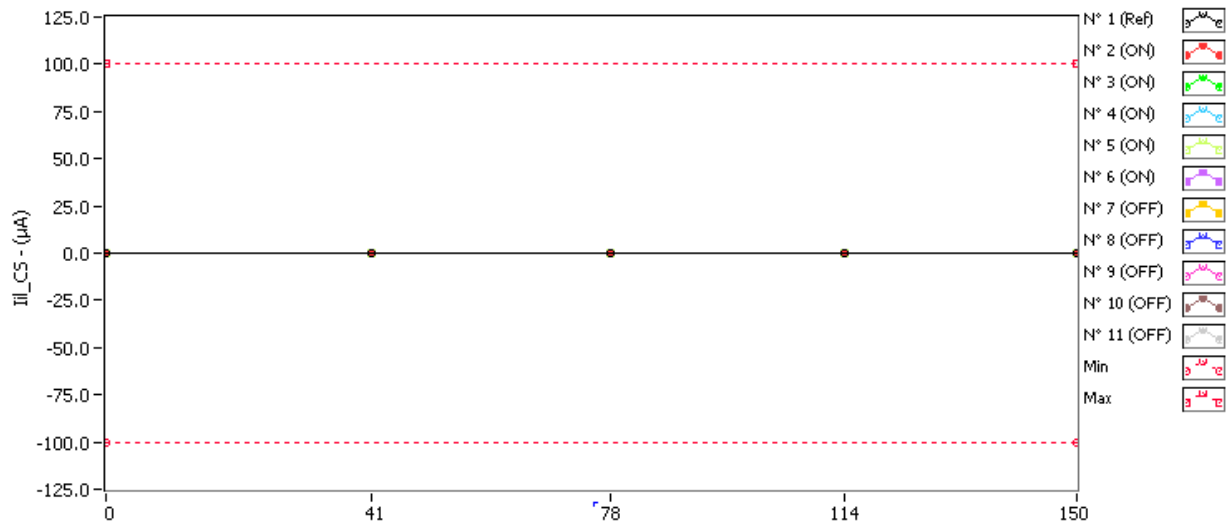

IIL_CS (µA) Min = -100.0 Max = 100.0

	0krad(Si)	41krad(Si)	78krad(Si)	114krad(Si)	150krad(Si)
N° 1 (Ref)	9.629E-5	7.988E-5	9.344E-5	9.413E-5	1.452E-4
N° 2 (ON)	1.293E-4	1.008E-4	8.834E-5	8.146E-5	8.176E-5
N° 3 (ON)	9.032E-5	1.017E-4	9.278E-5	8.559E-5	8.598E-5
N° 4 (ON)	9.204E-5	1.003E-4	9.075E-5	8.518E-5	8.613E-5
N° 5 (ON)	1.337E-4	1.064E-4	9.582E-5	9.097E-5	8.400E-5
N° 6 (ON)	1.200E-4	1.004E-4	8.302E-5	7.795E-5	2.971E-5
N° 7 (OFF)	1.314E-4	9.813E-5	8.900E-5	8.345E-5	7.688E-5
N° 8 (OFF)	8.734E-5	9.890E-5	8.841E-5	8.290E-5	7.582E-5
N° 9 (OFF)	8.859E-5	9.889E-5	8.990E-5	8.546E-5	7.214E-5
N° 10 (OFF)	9.724E-5	1.062E-4	9.458E-5	8.704E-5	7.802E-5
N° 11 (OFF)	9.016E-5	1.001E-4	9.012E-5	7.308E-5	7.487E-5

Delta [IIL_CS]

	0krad(Si)	41krad(Si)	78krad(Si)	114krad(Si)	150krad(Si)
N° 1 (Ref)	---	-1.640E-5	-2.851E-6	-2.158E-6	4.888E-5
N° 2 (ON)	---	-2.855E-5	-4.099E-5	-4.787E-5	-4.757E-5
N° 3 (ON)	---	1.139E-5	2.459E-6	-4.731E-6	-4.341E-6
N° 4 (ON)	---	8.231E-6	-1.286E-6	-6.859E-6	-5.912E-6
N° 5 (ON)	---	-2.733E-5	-3.788E-5	-4.273E-5	-4.970E-5
N° 6 (ON)	---	-1.957E-5	-3.695E-5	-4.202E-5	-9.026E-5
N° 7 (OFF)	---	-3.326E-5	-4.239E-5	-4.794E-5	-5.451E-5
N° 8 (OFF)	---	1.157E-5	1.073E-6	-4.435E-6	-1.152E-5
N° 9 (OFF)	---	1.030E-5	1.306E-6	-3.136E-6	-1.645E-5
N° 10 (OFF)	---	8.944E-6	-2.662E-6	-1.020E-5	-1.922E-5
N° 11 (OFF)	---	9.924E-6	-4.100E-8	-1.708E-5	-1.529E-5
Average (ON)	---	-1.117E-5	-2.293E-5	-2.884E-5	-3.956E-5
s (ON)	---	1.949E-5	2.156E-5	2.117E-5	3.574E-5
Average+3s (ON)	---	4.730E-5	4.175E-5	3.468E-5	6.767E-5
Average-3s (ON)	---	-6.963E-5	-8.761E-5	-9.236E-5	-1.468E-4
Average (OFF)	---	1.494E-6	-8.543E-6	-1.656E-5	-2.340E-5
s (OFF)	---	1.945E-5	1.899E-5	1.839E-5	1.761E-5
Average+3s (OFF)	---	5.985E-5	4.842E-5	3.861E-5	2.944E-5
Average-3s (OFF)	---	-5.686E-5	-6.550E-5	-7.172E-5	-7.624E-5

47. Iil_CE

Ta= 25°C ; Vcc = 5V ; Vin = 0V

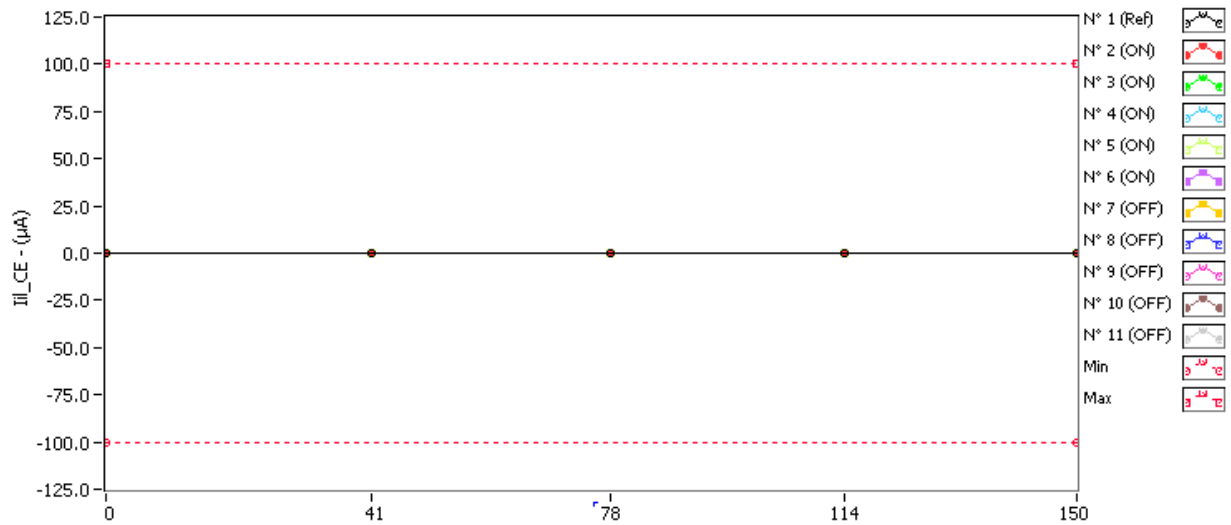

Iil_CE . (µA) Min = -100.0 Max = 100.0

	0krad(Si)	41krad(Si)	78krad(Si)	114krad(Si)	150krad(Si)
N° 1 (Ref)	7.099E-5	7.243E-5	6.982E-5	7.141E-5	7.997E-5
N° 2 (ON)	7.657E-5	5.124E-5	4.215E-5	3.670E-5	3.827E-5
N° 3 (ON)	7.314E-5	4.863E-5	4.117E-5	3.628E-5	3.447E-5
N° 4 (ON)	7.026E-5	4.476E-5	3.602E-5	2.940E-5	2.718E-5
N° 5 (ON)	6.547E-5	4.456E-5	3.809E-5	3.395E-5	2.638E-5
N° 6 (ON)	6.419E-5	4.122E-5	4.062E-5	2.890E-5	3.370E-5
N° 7 (OFF)	7.623E-5	6.162E-5	3.960E-5	3.481E-5	2.926E-5
N° 8 (OFF)	6.780E-5	4.346E-5	3.491E-5	2.993E-5	2.190E-5
N° 9 (OFF)	7.073E-5	4.841E-5	3.753E-5	3.384E-5	2.759E-5
N° 10 (OFF)	7.973E-5	5.301E-5	4.375E-5	3.799E-5	2.600E-5
N° 11 (OFF)	6.983E-5	4.609E-5	3.762E-5	3.230E-5	2.154E-6

Delta [Iil_CE]

	0krad(Si)	41krad(Si)	78krad(Si)	114krad(Si)	150krad(Si)
N° 1 (Ref)	---	1.440E-6	-1.174E-6	4.160E-7	8.975E-6
N° 2 (ON)	---	-2.533E-5	-3.441E-5	-3.987E-5	-3.830E-5
N° 3 (ON)	---	-2.451E-5	-3.197E-5	-3.686E-5	-3.867E-5
N° 4 (ON)	---	-2.550E-5	-3.424E-5	-4.086E-5	-4.308E-5
N° 5 (ON)	---	-2.091E-5	-2.738E-5	-3.152E-5	-3.910E-5
N° 6 (ON)	---	-2.297E-5	-2.357E-5	-3.529E-5	-3.049E-5
N° 7 (OFF)	---	-1.461E-5	-3.663E-5	-4.142E-5	-4.697E-5
N° 8 (OFF)	---	-2.434E-5	-3.289E-5	-3.787E-5	-4.590E-5
N° 9 (OFF)	---	-2.232E-5	-3.320E-5	-3.689E-5	-4.314E-5
N° 10 (OFF)	---	-2.671E-5	-3.598E-5	-4.174E-5	-5.373E-5
N° 11 (OFF)	---	-2.374E-5	-3.221E-5	-3.753E-5	-6.767E-5
Average (ON)	---	-2.384E-5	-3.031E-5	-3.688E-5	-3.793E-5
s (ON)	---	1.921E-6	4.719E-6	3.741E-6	4.580E-6
Average+3s (ON)	---	-1.808E-5	-1.616E-5	-2.566E-5	-2.419E-5
Average-3s (ON)	---	-2.961E-5	-4.447E-5	-4.810E-5	-5.167E-5
Average (OFF)	---	-2.234E-5	-3.418E-5	-3.909E-5	-5.148E-5
s (OFF)	---	4.606E-6	1.986E-6	2.303E-6	9.853E-6
Average+3s (OFF)	---	-8.525E-6	-2.823E-5	-3.218E-5	-2.192E-5
Average-3s (OFF)	---	-3.616E-5	-4.014E-5	-4.600E-5	-8.104E-5