

PROTONS DISPLACEMENT DAMAGE TEST REPORT

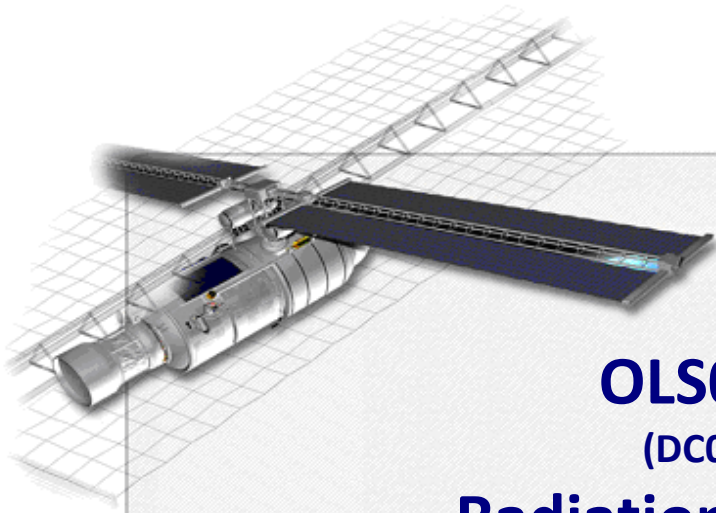

OLS0449 (DC0949) Radiation Tolerant Hermetic Surface Mount Optocoupler From ISOLINK

TRAD/TP/OLS449/XXX1/ESA/YP/1104		Labège, April 16th, 2012
 		TRAD, Bât Gallium 907, Voie l'Occitane - 31670 LABEGE France ☎ : 05 61 00 95 60 Fax : 05 61 00 95 61 Email : trad@trad.fr Web Site: www.trad.fr SIRET 397 862 038 00056 - TVA FR59397862038
Written by	Verified by / Quality control	Approved by
A. SAMARAS 10/04/2012	M.SAUVAGNAC/Y.PADIE 16/04/2012	C.CHATRY 16/04/2012
Issue : 0		
To: Marc POIZAT	Project/Program :	ESA Contract N°4000102571/10/NL/AF-Radiation Characterization of Laplace RH optocouplers, sensors and detectors

TABLE OF CONTENT

1	INTRODUCTION	3
2	DOCUMENTS	3
2.1	Applicable Documents	3
2.2	Reference Documents.....	3
3	DEVICE INFORMATION.....	3
3.1	Device description.....	3
3.2	Procurement information	4
3.3	External view.....	4
3.4	Internal view	4
3.5	Serialization.....	5
4	IRRADIATION MEANS AND CONDITIONS	6
4.1	AGORFIRM/KVI irradiation facility (The Netherlands)	6
4.2	Energy and Flux measurement	6
4.3	Experimental conditions	6
5	ELECTRICAL TESTS.....	7
5.1	Test set-up	7
5.2	Test configuration.....	7
5.3	Electrical parameters	8
6	TEST HISTORY	8
7	SUMMARY RESULTS.....	8
7.1	30 MeV proton irradiation summary results	9
7.2	60 MeV proton irradiation summary results	10
7.3	190 MeV proton irradiation summary results	11
8	CONCLUSION.....	12
9	DETAILED TESTS RESULTS.....	15

LIST OF FIGURES

Figure 1:	package marking.....	4
Figure 2:	package view and back-side	4
Figure 3:	Internal overall view	4
Figure 4:	view of photodetector and LED.....	4
Figure 5:	samples installed for irradiation.....	6
Figure 6:	test principle	7
Figure 7:	ON bias1	8
Figure 8:	ON bias2.....	8
Figure 9:	ON Bias 1 under 30 MeV protons	9
Figure 10:	ON Bias 2 under 30 MeV protons	9
Figure 11:	OFF Bias under 30 MeV protons.....	9
Figure 12:	ON Bias 1 under 60 MeV protons	10
Figure 13:	ON Bias 2 under 60 MeV protons	10
Figure 14:	OFF Bias under 60 MeV protons.....	10
Figure 15:	ON Bias 1 under 190 MeV protons	11
Figure 16:	ON Bias 2 under 190 MeV protons	11
Figure 17:	OFF Bias under 190 MeV protons.....	11
Figure 18:	Average drift current transfer ratio under 30 MeV protons	13
Figure 19:	Average drift current transfer ratio under 60 MeV protons	14
Figure 20:	Average drift current transfer ratio under 190 MeV protons	14

1 INTRODUCTION

This report includes the test results of OLS0449, a hermetic surface mount Optocoupler from ISOLINK to evaluate displacement damage effects under proton irradiation. During January and February 2012, TRAD characterized this device for proton sensitivity at the KVI Facility, in GRONINGEN, The Netherlands using their AGOR cyclotron.

The objectives of the test are:

- to detect and measure the degradation of device parameters as a function of proton fluence,
- to determine if device parameters are within specified limits after exposure to final level of proton fluence.

2 DOCUMENTS

2.1 Applicable Documents

AD	1.	ESA contract	N°4000102571/10/NL/AF-Radiation Characterization of Laplace RH optocouplers, sensors and detectors
AD	2.	Irradiation Test Plan	ITP-TP-OLS449-ISO-ESA-1119, Iss.5, 19/03/2012

2.2 Reference Documents

RD	1.	Datasheet OLS449	Radiation Tolerant Phototransistor Hermetic Surface Mount Optocouplers
----	----	------------------	--

3 DEVICE INFORMATION

3.1 Device description

The OL449 is designed for hi-rel and space applications requiring optical isolation in radiation environments such as gamma, neutron and proton radiation with high current transfer ratio (CTR) and low saturation Vce. OLH449 presents same reliable processing and construction as the well-known OLS249 but with higher CTR and using a GaAlAs LED generating three times more current. Each optocoupler consists of a light emitting diode and a NPN silicon phototransistor electrically isolated but optically coupled inside a hermetic 6-pin leadless chip carrier package. Electrical parameters are similar to the JEDEC registered 4N49U optocoupler but with higher CTR and much better CTR degradation characteristics due to radiation exposure

Type	OLS0449
Manufacturer	ISOLINK
Function	Optocoupler
Package	LCC4
Date Code	0949
Sample size	46 parts (3X15 test parts + 1 control sample)

3.2 Procurement information

75 parts OLS449 were procured from ISOLINK through the French representative EUROMIP. Parts delivered are OLS0449, containing same die than the OLS449 but packaged in a LCC4 instead of a LCC6.

3.3 External view



Figure 1: package marking

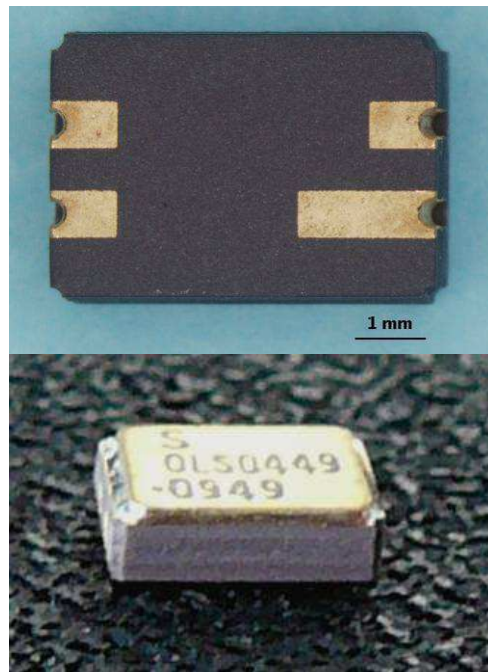

Figure 2: package view and back-side

3.4 Internal view

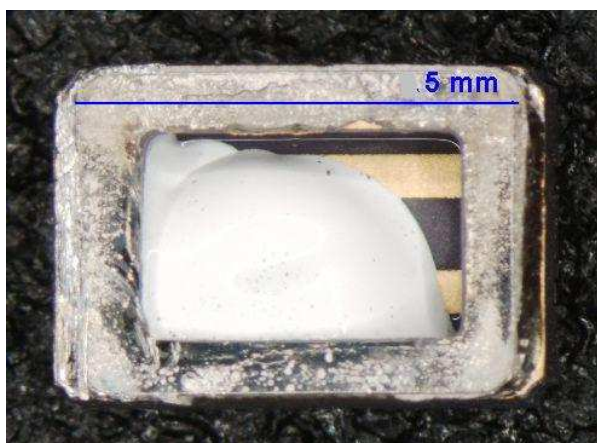

Figure 3: Internal overall view

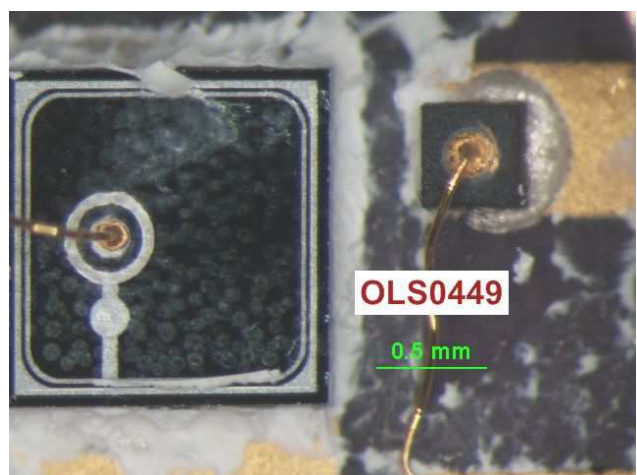

Figure 4: view of photodetector and LED

3.5 Serialization

Each part is serialized to enable pre and post test identification and comparison.

Serial Number			
P1 (30MeV)	P2 (60MeV)	P3 (190MeV)	Mode
1 (Control sample)			
2	2	2	Bias 1
3	3	3	Bias 1
4	4	4	Bias 1
5	5	5	Bias 1
6	6	6	Bias 1
7	7	7	Bias 2
8	8	8	Bias 2
9	9	9	Bias 2
10	10	10	Bias 2
11	11	11	Bias 2
12	12	12	Off
13	13	13	Off
14	14	14	Off
15	15	15	Off
16	16	16	Off

4 IRRADIATION MEANS AND CONDITIONS

4.1 AGORFIRM/KVI irradiation facility (The Netherlands)

AGORFIRM is a facility that uses a dedicated beam line of the AGOR cyclotron for irradiations with protons in air. The facility is available for radiation damage studies. The standard proton beams used for irradiations produced by this cyclotron have primary energies of 90, 150 and 190 MeV. The standard irradiation field has a diameter of 70 mm and homogeneity of better than $\pm 3\%$.



Figure 5: samples installed for irradiation

4.2 Energy and Flux measurement

The energy resolution of the beam when leaving the cyclotron is typically better than 0.25%. However, at the DUT position the resolution is in the order of a few MeV due to scattering in air, the scatter system and, when used, the energy degrader.

The proton flux at the centre of the irradiation field is measured with a 10 mm diameter scintillator detector. During the irradiation, the flux is monitored with a Beam Intensity Monitor (BIM). Before an irradiation the BIM signal (in Monitor Units) is related to the scintillator signal to obtain the flux calibration in protons cm^{-2} per MU. This calibration is conducted for every field size and every energy used during an irradiation.

4.3 Experimental conditions

An Equivalent total fluence of $1\text{E}12 \text{ \#/cm}^2$ of 10 MeV protons is required [AD2] for this TNID (Total Non-Ionizing Dose) evaluation test. Considering NIEL (Non Ionizing Energy Loss) value for 10 MeV proton ($7.86\text{E}-03 \text{ MeV cm}^2 \text{ g}^{-1}$), total fluence to be reached at each energy is:

30	MeV	$8,22\text{E}+11 \text{ cm}^{-2}$
60	MeV	$1,14\text{E}+12 \text{ cm}^{-2}$
190	MeV	$1,91\text{E}+12 \text{ cm}^{-2}$

Five steps were defined to determine the component degradation under 30MeV, 60MeV, 190MeV proton irradiation. The test devices have been exposed to the following proton fluence levels:

p/cm2	1,70E+10	8,50E+10	1,70E+11	1,70E+12
Energy (MeV)	30	30	30	30
p/cm2	2,30E+10	1,15E+11	2,30E+11	1,14E+12
Energy (MeV)	60	60	60	60
p/cm2	4,00E+10	2,00E+11	4,00E+11	1,91E+12
Energy (MeV)	190	190	190	190

5 ELECTRICAL TESTS

Electrical parameters to be measured in pre and post exposure tests are described in the following table. Electrical tests are performed on each part using the test set-up hereunder. All required data are recorded for each device. Test conditions and limits are given in the applicable irradiation test plan [AD2] and shown hereafter.

5.1 Test set-up

TEST BOARD	TRAD/CT1/N/OPTO/ZIP14/BR/1109
TEST PROGRAM	OLS049_TP30MeV_XXX1_B1_V10.Ilb OLS049_TP60MeV_XXX1_B1_V10.Ilb OLS049_TP200MeV_XXX1_B1_V10.Ilb

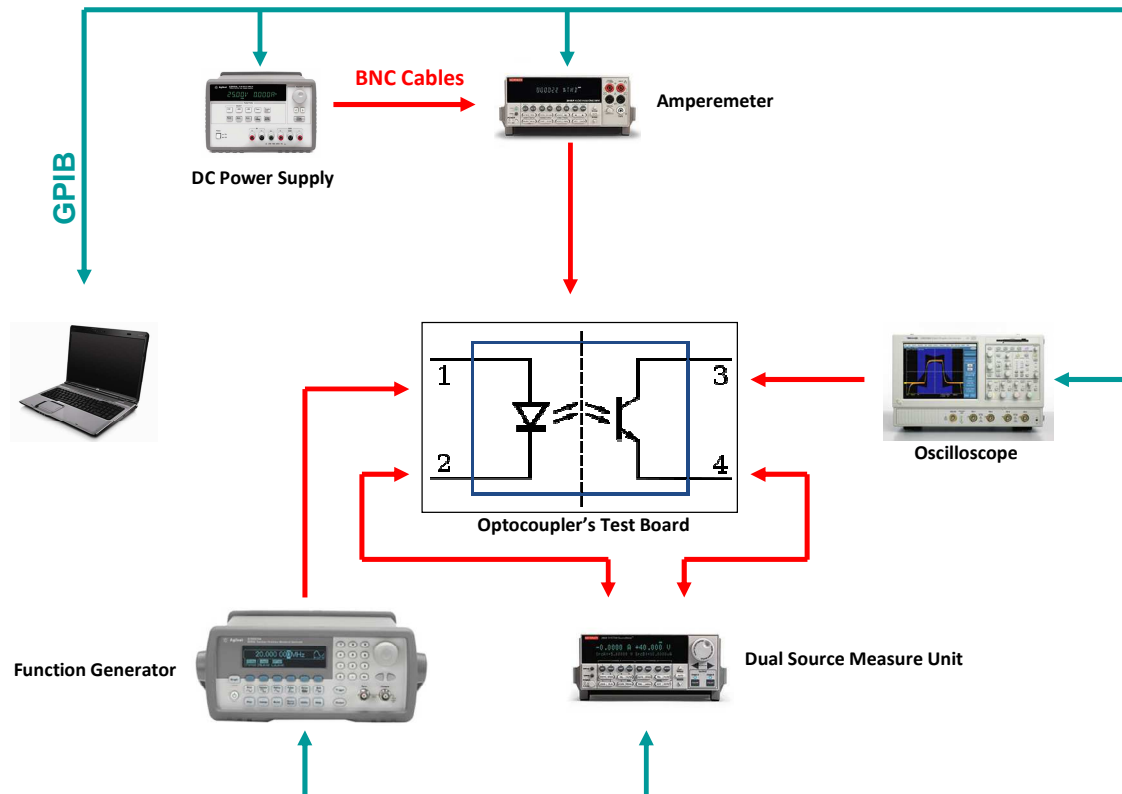

Figure 6: test principle

5.2 Test configuration

Samples were exposed to proton irradiation in three different modes - two on-modes (Figure 7 and Figure 8) and one off-mode (all terminal leads short-circuited) –

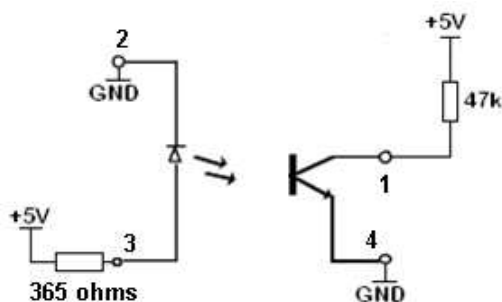

Figure 7: ON bias1

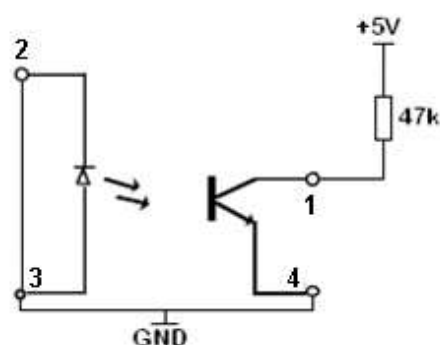

Figure 8: ON bias2

5.3 Electrical parameters

PARAMETER	SYMBOL	TEST CONDITION	MIN	MAX	UNIT
On-State Collector Current	CTR1/IC(ON)	IF = 1 mA, VCE = 5.0V	15	40	mA
Saturation Voltage	VCE(SAT)	IF = 1 mA, IC = 5.0mA		0,3	V
Breakdown Voltage Collector to Emitter	BV _{CEO}	ICE = 1mA	65		V
Breakdown Voltage Collector to Emitter	BV _{ECO}	IEC=100μA			V
Leakage Current Collector to Emitter	ICE(OFF)	VCE = 20V		100	nA
Input Forward Voltage	VF	IF = 10mA	1,2	1,7	V
Input Reverse Current	IR	VR = 2.0V		100	μA
Rise Time	tr	VCC = 10V, RL = 100Ω, IF = 5mA		25	μs
Fall Time	tf	VCC = 10V, RL = 100Ω, IF = 5mA		25	μs
Current transfer ratio	CTR1	IF = 1 mA, Vce = 5.0V	1500	4000	%
	CTR2	If = 2mA, Vce = 5V			%
	CTR3	If = 10mA, Vce = 5V			%
	CTR4	If = 40mA, Vce = 5V			%
	CTR5	If = 10mA, Vce = 32V			%
Input Diode Reverse Recovery Time	Trr	If = 2mA, RI = 100Ω, Irec = 10% Irm			ns

Min/ Max values are those specified in the reference data-sheet [RD1].

Test measurements are performed at 25°C ± 10°C.

6 TEST HISTORY

Test sequence and all required conditions were executed as described in the test plan.
No incident during the test was noticed.

7 SUMMARY RESULTS

7.1 30 MeV proton irradiation summary results

Only the parameters with applicable test limits are shown hereunder.

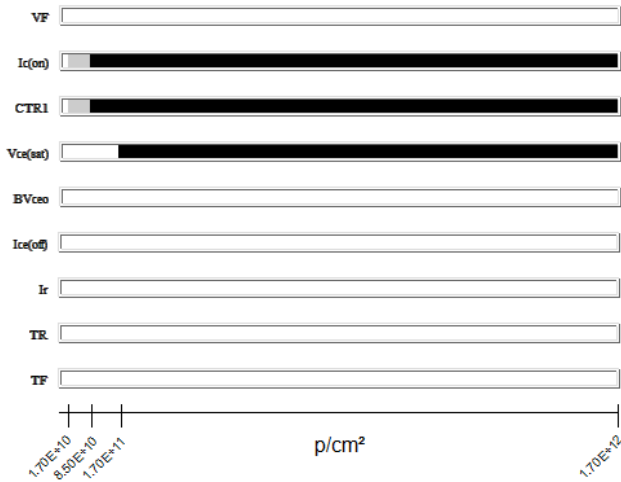

Figure 9: ON Bias 1 under 30 MeV protons

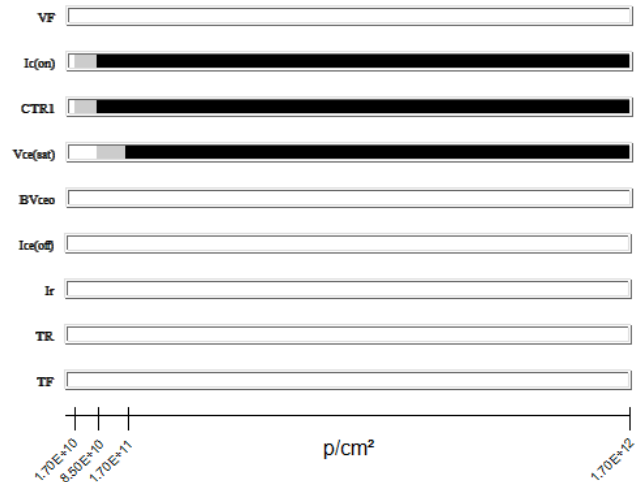

Figure 10: ON Bias 2 under 30 MeV protons

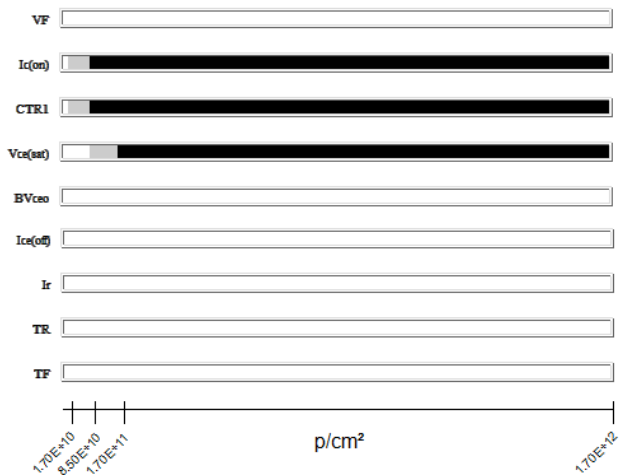
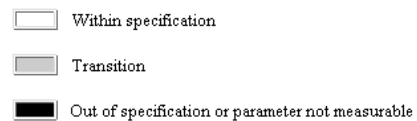

Figure 11: OFF Bias under 30 MeV protons



Ic(on) and CTR1 are out of specification, whatever the Bias mode, at step 8.5E10.p/cm²:

- Ic(on) and CTR1, with the condition ON Bias1, are out of specification at 7.1 E10.p/cm² by interpolation
- The Figure 10 shows that, with the condition ON Bias2, Ic(on) and CTR1 are out of specification at 6.2 E+10.p/cm² by interpolation
- In OFF state, Ic(on) and CTR1 are out of specification at 6.6 E+10.p/cm² by interpolation

The parameter Vce(sat) is not measurable, whatever the Bias mode, at step 1.7E12.p/cm²:

- The Figure 10 shows that, with the condition ON Bias2, the parameter Vce(sat) is out of specification at 8.8 E10.p/cm² by interpolation.
- In OFF state, the parameter Vce(sat) is out of specification at 1.47 E+11.p/cm² by interpolation.

7.2 60 MeV proton irradiation summary results

Only the parameters with applicable test limits are shown hereunder.

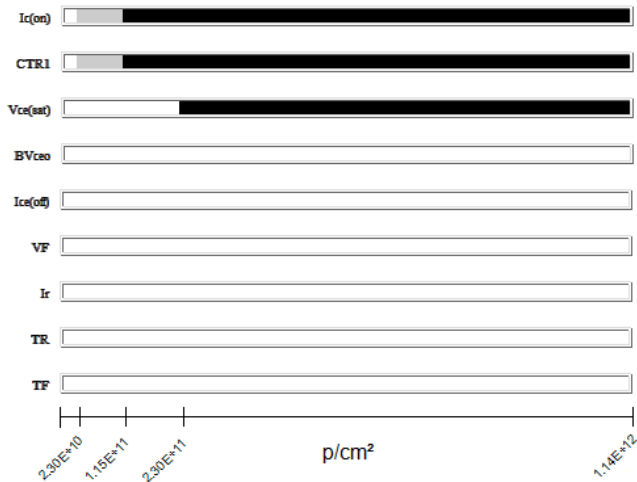

Figure 12: ON Bias 1 under 60 MeV protons

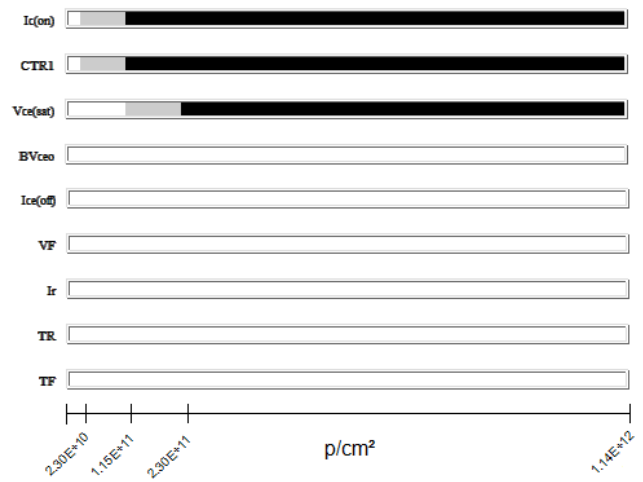

Figure 13: ON Bias 2 under 60 MeV protons

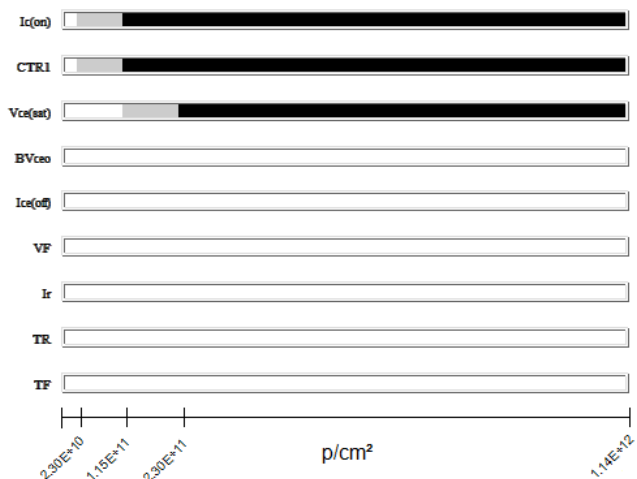

Figure 14: OFF Bias under 60 MeV protons

Within specification
 Transition
 Out of specification or parameter not measurable

Ic(on) and CTR1 are out of specification, whatever the Bias mode, at step 1.15E11.p/cm².

- Ic(on) and CTR1, with the condition ON Bias1, are out of specification at 9.9 E10.p/cm² by interpolation
- The figure 13 shows that, with the condition ON Bias2, Ic(on) and CTR1 are out of specification at 9.4 E+10.p/cm² by interpolation
- In OFF state, Ic(on) and CTR1 are out of specification at 8.1 E+10.p/cm² by interpolation

The parameter Vce(sat) is not measurable, whatever the Bias mode, at step 1.14E12.p/cm².

- The figure 13 shows that, with the condition ON Bias2, the parameter Vce(sat) is out of specification at 2.02E11.p/cm² by interpolation.
- In OFF state, the parameter Vce(sat) is out of specification at 2.04E11 E+11.p/cm² by interpolation.

7.3 190 MeV proton irradiation summary results

Only the parameters with applicable test limits are shown hereunder.

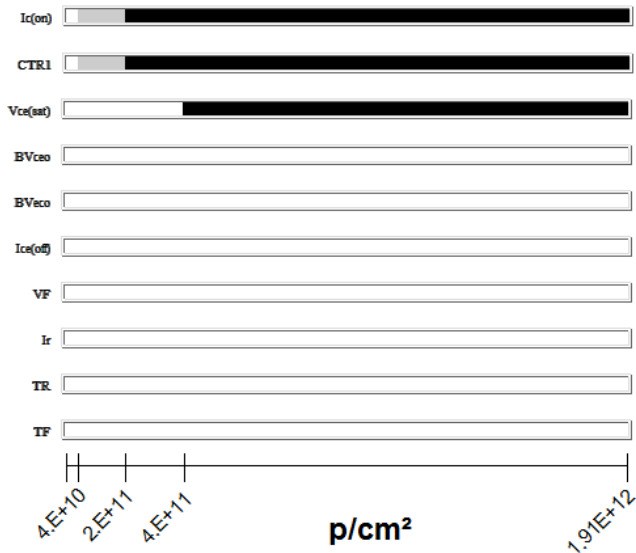

Figure 15: ON Bias 1 under 190 MeV protons

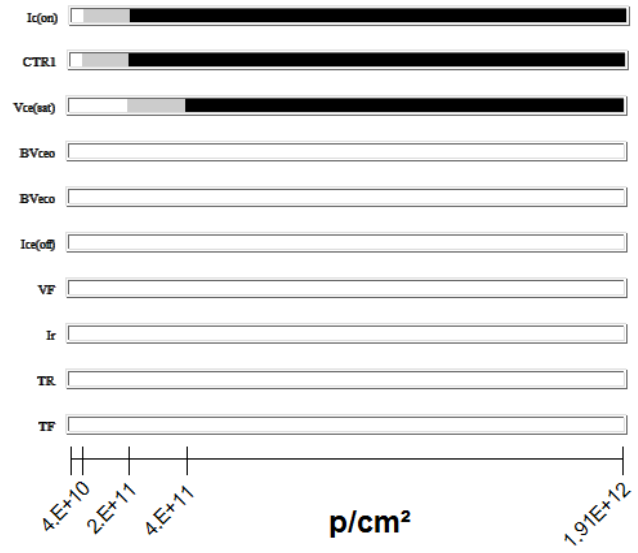

Figure 16: ON Bias 2 under 190 MeV protons

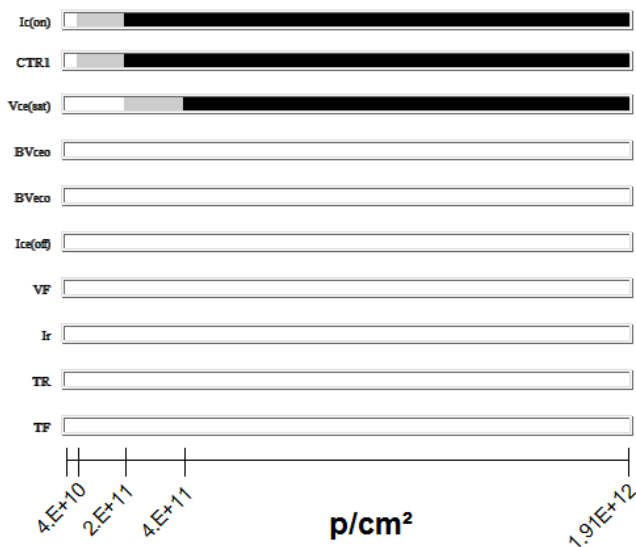

Figure 17: OFF Bias under 190 MeV protons

Within specification
 Transition
 Out of specification or parameter not measurable

Ic(on) and CTRL are out of specification, whatever the Bias mode, at step 2E11.p/cm².

- Ic(on) and CTRL are out of specification at 1.78 E11.p/cm² by interpolation under ON Bias1 mode (Figure15)
- Ic(on) and CTRL are out of specification at 1.43 E+11.p/cm² by interpolation under ON Bias2 mode (Figure 16).
- In OFF mode, Ic(on) and CTRL are out of specification at 1.51 E+11.p/cm² by interpolation (figure 17).

Vce(sat) is not measurable, whatever the Bias mode, at step 4E11.p/cm².

- In ON Bias2 mode, Vce(sat) is out of specification at 3.48E11.p/cm² by interpolation.
- In OFF mode, Vce(sat) is out of specification at 3.47E11 E+11.p/cm² by interpolation.

8 CONCLUSION

Total fluence steady-state irradiation test using protons has been applied on OLS0449 type, Radiation Tolerant Phototransistor Hermetic Surface Mount Optocoupler from ISOLINK:

- up to 1.7E+12 protons/cm², with an energy of 30 MeV
- up to 1,14E+12 protons/cm², with an energy of 60 MeV
- up to 1,91E+12 protons/cm², with an energy of 190 MeV

The results indicate that:

- Under 30MeV proton Beam: Components are functional up to 1.7E10p/cm².
Ic(on) and Vce(sat) drifts are observed with the three bias conditions.
OFF and ON Bias2 conditions are more sensitive to proton displacement damage.
- Under 60MeV proton Beam: Components are functional up to 2.3E10p/cm².
Ic(on) and Vce(sat) drifts are observed with the three bias conditions.
OFF and ON Bias2 conditions are more sensitive to proton displacement damage.
- Under 190MeV proton Beam: Components are functional up to 4E10p/cm².
Ic(on) and Vce(sat) drifts are observed with the three bias conditions.
OFF and ON Bias2 conditions are more sensitive to proton displacement damage.

CTR drifts are different according to proton energy:

Under 30 MeV proton irradiation:

- CTR4 configuration (If = 40mA, Vce = 5V) exhibits the smallest average parameter drift whatever the bias condition, while CRT1 configuration (If = 1mA, Vce = 5V) exhibits the greater parameter degradation.
- All CTR configurations exhibit the smallest parameter degradation when tested in ON Bias1 mode.
- Conversely, all CTR configurations exhibit the greatest parameter degradation when tested in ON Bias2 mode.

Under 60 MeV proton irradiation:

- CTR5 configuration (If = 10mA, Vce = 32V) exhibits the smallest average parameter drift whatever the bias condition, while CRT1 configuration (If = 1mA, Vce = 5V) exhibits the greater parameter degradation.
- All CTR configurations exhibit the smallest average parameter degradation when tested in ON Bias1 mode.
- Conversely, all CTR configurations exhibit the greatest parameter degradation when tested in OFF mode.

Under 190 MeV proton irradiation:

- CTR5 configuration ($I_f = 10\text{mA}$, $V_{ce} = 32\text{V}$) exhibits the smallest average parameter drift whatever the Bias condition, while CRT1 configuration ($I_f = 1\text{mA}$, $V_{ce} = 5\text{V}$) exhibits the greater parameter degradation.
- All CTR configurations exhibit the smallest average parameter degradation when tested in ON Bias1 mode.
- Conversely, all CTR configurations exhibit the greatest parameter degradation when tested in ON Bias2 mode.

Moreover CTR1 ($I_f = 1\text{ mA}$, $V_{ce} = 5.0\text{V}$), which is the only CTR configuration for which a specification limit is indicated in the data-sheet, is out of specification at step $8.5\text{E}10\text{p}/\text{cm}^2$ with 30MeV proton, at step $1.15\text{E}11.\text{p}/\text{cm}^2$ with 60MeV proton and at step $2\text{E}11.\text{p}/\text{cm}^2$ with 190MeV proton.

Average drift current transfer ratio are shown in next Figures depending on proton energy, CTR configuration and bias condition at final irradiation step.

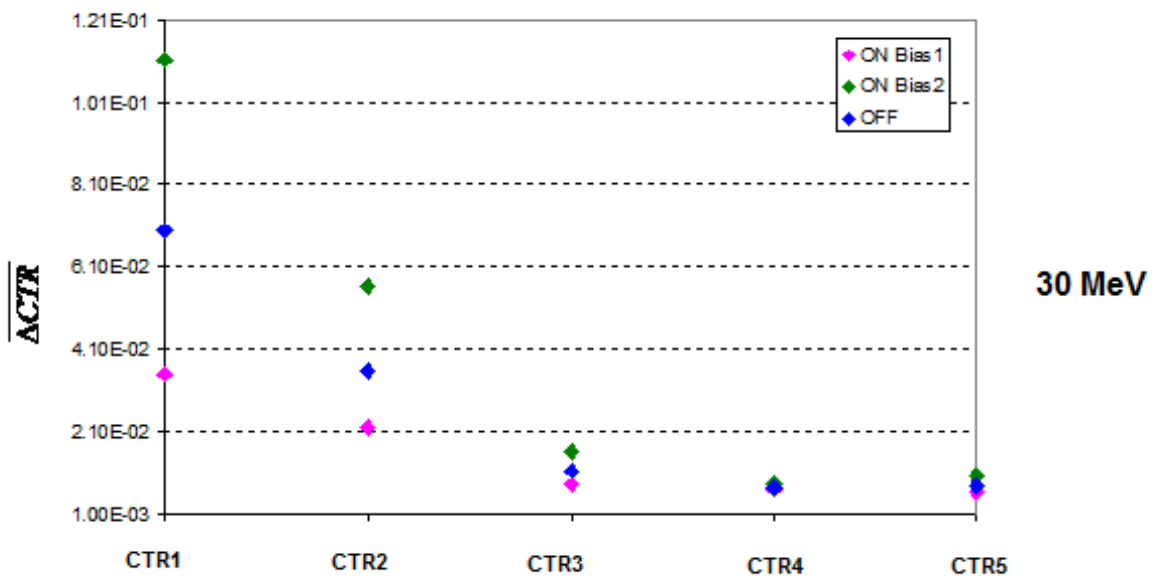

Figure 18: Average drift current transfer ratio under 30 MeV protons

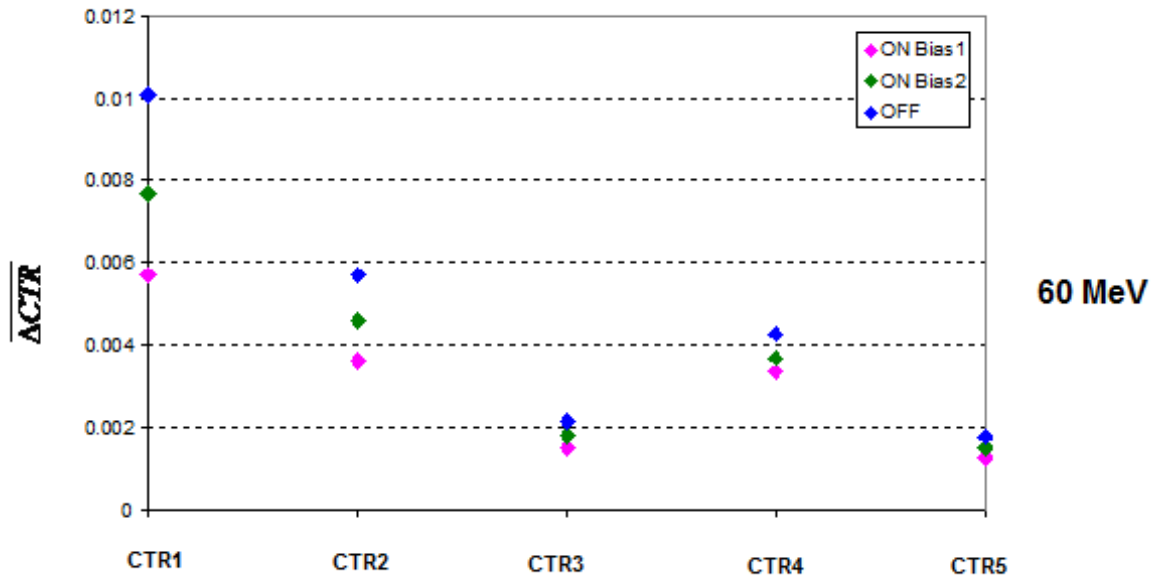

Figure 19: Average drift current transfer ratio under 60 MeV protons

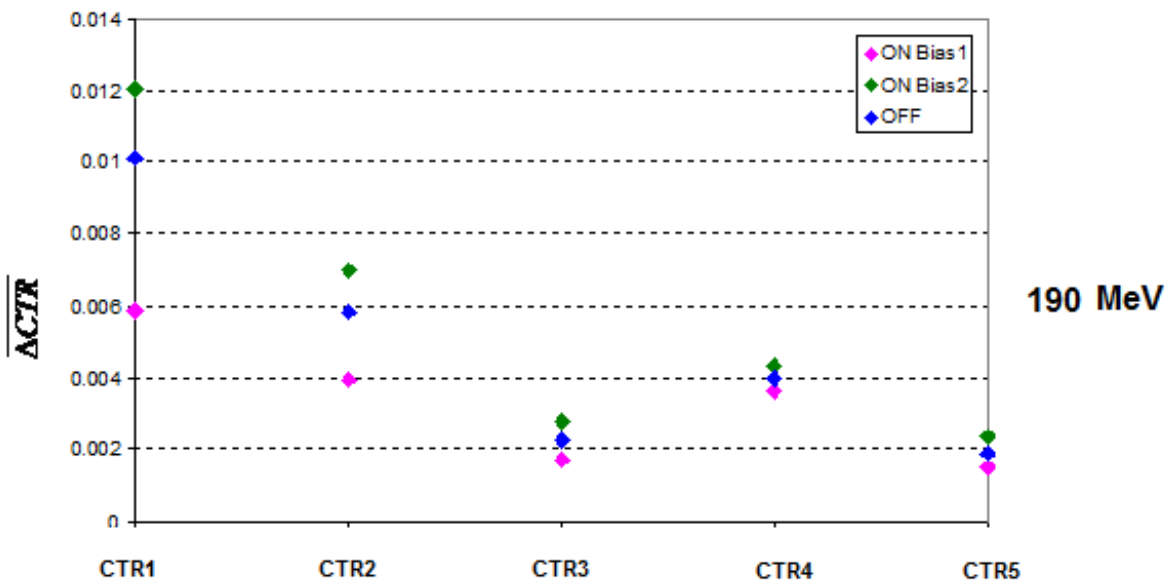

Figure 20: Average drift current transfer ratio under 190 MeV protons

9 DETAILED TESTS RESULTS

The pre and post radiation test results are shown graphically in the following pages:

- 30MeV: 9-2 to 9-31
- 60MeV: 10-2 to 10-31
- 190MeV: 11-2 to 11-31

The data is displayed in the following tables and graphs.

These graphs show parameter's shifts observed during the proton testing sequence. The Control sample results are shown on each graph (black curve).

When available in the device data-sheet/specification, the maximum/minimum/typical values are also shown (red dotted line).

The tables include drift calculation between each measurement step and the "0" proton/cm² step.

For CTR values, the formula used is:

$$\text{Drift} = \frac{1}{\text{measurement (X protons /cm}^2)} - \frac{1}{\text{measurement (0 proton /cm}^2)}$$

For the other measurements the formula used is:

$$\text{Drift value} = \text{measurement (X protons/cm}^2) - \text{measurement (0 proton/cm}^2)$$

30 MeV proton / detailed results

CONTENTS

1. Ic(on)	2
2. CTR1	4
3. Vce(sat)	6
4. BVceo	8
5. BVeco	10
6. Ice(off)	12
7. VF	14
8. Ir	16
9. TR	18
10. TF	20
11. CTR2	22
12. CTR3	24
13. CTR4	26
14. CTR5	28
15. TRR	30

30 MeV proton / detailed results

1. $I_c(on)$

$T_a = 25^\circ C$; $I_F = 1mA$; $V_{ce} = 5V$

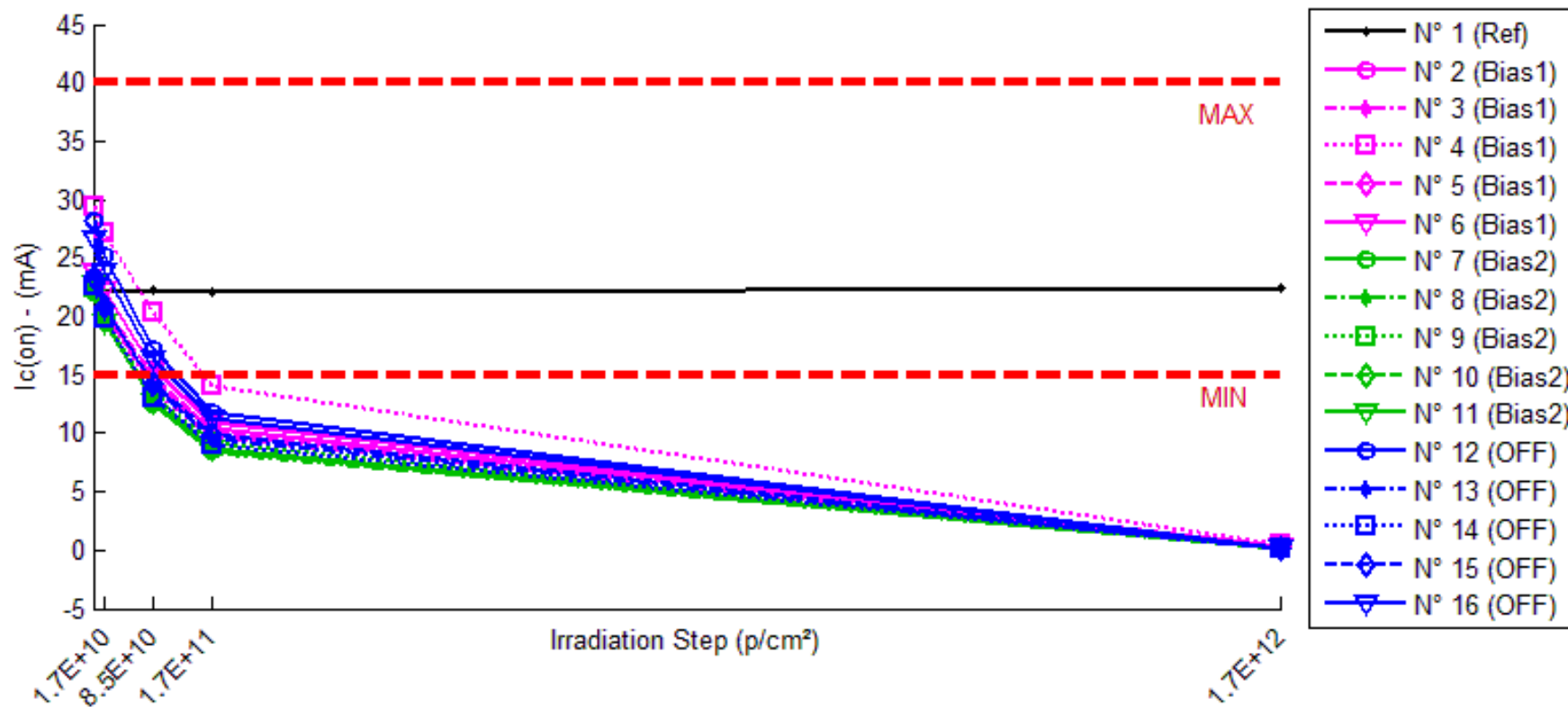

30 MeV proton / detailed results

Ic(on) . (mA)

Min = 2.0

	0.p/cm ²	1.7E10.p/cm ²	8.5E10.p/cm ²	1.7E11.p/cm ²	1.7E12.p/cm ²
N° 1 (Ref)	22.262	22.138	22.185	22.131	22.509
N° 2 (Bias1)	22.885	20.521	14.130	10.447	0.267
N° 3 (Bias1)	22.873	20.329	13.666	9.657	0.194
N° 4 (Bias1)	29.439	27.100	20.322	13.998	0.488
N° 5 (Bias1)	22.652	20.793	14.970	10.098	0.269
N° 6 (Bias1)	23.790	22.248	15.529	11.000	0.335
N° 7 (Bias2)	22.162	19.919	12.424	8.496	0.097
N° 8 (Bias2)	22.184	19.705	12.743	8.380	0.090
N° 9 (Bias2)	22.390	19.758	13.215	9.138	0.086
N° 10 (Bias2)	22.259	19.594	12.847	8.694	0.096
N° 11 (Bias2)	22.728	19.467	12.732	8.631	0.082
N° 12 (OFF)	28.113	25.284	17.238	11.829	0.175
N° 13 (OFF)	23.637	20.937	14.066	9.570	0.132
N° 14 (OFF)	22.641	19.769	13.101	9.008	0.091
N° 15 (OFF)	23.306	20.933	14.323	9.921	0.178
N° 16 (OFF)	26.689	23.895	16.360	11.350	0.195

Delta [Ic(on)]

	0.p/cm ²	1.7E10.p/cm ²	8.5E10.p/cm ²	1.7E11.p/cm ²	1.7E12.p/cm ²
N° 1 (Ref)	---	-1.246E-1	-7.792E-2	-1.317E-1	2.469E-1
N° 2 (Bias1)	---	-2.364E+0	-8.755E+0	-1.244E+1	-2.262E+1
N° 3 (Bias1)	---	-2.544E+0	-9.206E+0	-1.322E+1	-2.268E+1
N° 4 (Bias1)	---	-2.339E+0	-9.117E+0	-1.544E+1	-2.895E+1
N° 5 (Bias1)	---	-1.859E+0	-7.682E+0	-1.255E+1	-2.238E+1
N° 6 (Bias1)	---	-1.543E+0	-8.261E+0	-1.279E+1	-2.346E+1
N° 7 (Bias2)	---	-2.243E+0	-9.739E+0	-1.367E+1	-2.207E+1
N° 8 (Bias2)	---	-2.479E+0	-9.441E+0	-1.380E+1	-2.209E+1
N° 9 (Bias2)	---	-2.632E+0	-9.175E+0	-1.325E+1	-2.230E+1
N° 10 (Bias2)	---	-2.665E+0	-9.412E+0	-1.357E+1	-2.216E+1
N° 11 (Bias2)	---	-3.261E+0	-9.997E+0	-1.410E+1	-2.265E+1
N° 12 (OFF)	---	-2.829E+0	-1.087E+1	-1.628E+1	-2.794E+1
N° 13 (OFF)	---	-2.700E+0	-9.571E+0	-1.407E+1	-2.351E+1
N° 14 (OFF)	---	-2.873E+0	-9.540E+0	-1.363E+1	-2.255E+1
N° 15 (OFF)	---	-2.372E+0	-8.983E+0	-1.338E+1	-2.313E+1
N° 16 (OFF)	---	-2.794E+0	-1.033E+1	-1.534E+1	-2.649E+1
Average (OFF)	---	-2.130E+0	-8.605E+0	-1.329E+1	-2.402E+1
σ (OFF)	---	4.148E-1	6.355E-1	1.240E+0	2.787E+0
Average+3σ (OFF)	---	-8.855E-1	-6.698E+0	-9.569E+0	-1.565E+1
Average-3σ (OFF)	---	-3.374E+0	-1.051E+1	-1.701E+1	-3.238E+1
Average (Bias1)	---	-2.656E+0	-9.553E+0	-1.368E+1	-2.225E+1
σ (Bias1)	---	3.770E-1	3.188E-1	3.107E-1	2.378E-1
Average+3σ (Bias1)	---	-1.525E+0	-8.596E+0	-1.275E+1	-2.154E+1
Average-3σ (Bias1)	---	-3.787E+0	-1.051E+1	-1.461E+1	-2.297E+1
Average (Bias2)	---	-2.714E+0	-9.860E+0	-1.454E+1	-2.472E+1
σ (Bias2)	---	2.012E-1	7.424E-1	1.231E+0	2.357E+0
Average+3σ (Bias2)	---	-2.110E+0	-7.632E+0	-1.085E+1	-1.765E+1
Average-3σ (Bias2)	---	-3.317E+0	-1.209E+1	-1.823E+1	-3.179E+1

30 MeV proton / detailed results

2. CTR1

Ta = 25°C ; IF = 1mA ; Vce = 5V

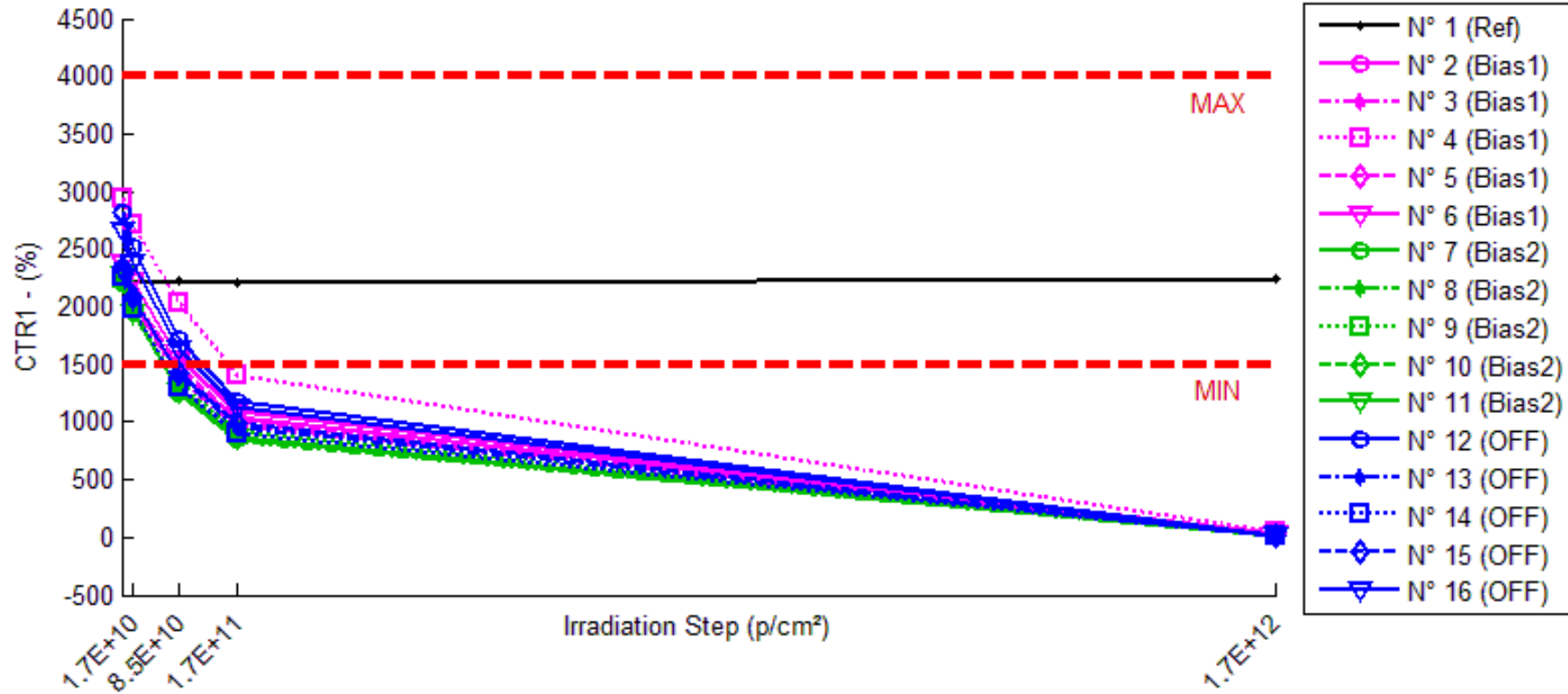

30 MeV proton / detailed results

CTR1 . (%)

	0.p/cm ²	1.7E10.p/cm ²	8.5E10.p/cm ²	1.7E11.p/cm ²	1.7E12.p/cm ²
N° 1 (Ref)	2226.25	2213.79	2218.46	2213.08	2250.94
N° 2 (Bias1)	2288.52	2052.09	1412.98	1044.69	26.74
N° 3 (Bias1)	2287.26	2032.89	1366.62	965.74	19.43
N° 4 (Bias1)	2943.89	2709.97	2032.20	1399.83	48.80
N° 5 (Bias1)	2265.24	2079.34	1496.99	1009.83	26.92
N° 6 (Bias1)	2379.04	2224.77	1552.91	1099.98	33.53
N° 7 (Bias2)	2216.23	1991.92	1242.38	849.64	9.72
N° 8 (Bias2)	2218.39	1970.52	1274.33	837.95	9.03
N° 9 (Bias2)	2238.97	1975.78	1321.45	913.78	8.58
N° 10 (Bias2)	2225.95	1959.42	1284.70	869.37	9.58
N° 11 (Bias2)	2272.83	1946.74	1273.15	863.10	8.16
N° 12 (OFF)	2811.32	2528.44	1723.84	1182.89	17.47
N° 13 (OFF)	2363.73	2093.74	1406.65	956.97	13.18
N° 14 (OFF)	2264.13	1976.86	1310.09	900.75	9.13
N° 15 (OFF)	2330.56	2093.35	1432.27	992.06	17.80
N° 16 (OFF)	2668.93	2389.49	1636.02	1135.01	19.52

1/Delta [CTR1]

	0.p/cm ²	1.7E10.p/cm ²	8.5E10.p/cm ²	1.7E11.p/cm ²	1.7E12.p/cm ²
N° 1 (Ref)	---	2.527E-6	1.578E-6	2.673E-6	-4.926E-6
N° 2 (Bias1)	---	5.035E-5	2.708E-4	5.203E-4	3.696E-2
N° 3 (Bias1)	---	5.471E-5	2.945E-4	5.983E-4	5.102E-2
N° 4 (Bias1)	---	2.932E-5	1.524E-4	3.747E-4	2.015E-2
N° 5 (Bias1)	---	3.947E-5	2.266E-4	5.488E-4	3.670E-2
N° 6 (Bias1)	---	2.915E-5	2.236E-4	4.888E-4	2.940E-2
N° 7 (Bias2)	---	5.081E-5	3.537E-4	7.258E-4	1.024E-1
N° 8 (Bias2)	---	5.670E-5	3.339E-4	7.426E-4	1.103E-1
N° 9 (Bias2)	---	5.949E-5	3.101E-4	6.477E-4	1.162E-1
N° 10 (Bias2)	---	6.111E-5	3.291E-4	7.010E-4	1.040E-1
N° 11 (Bias2)	---	7.370E-5	3.455E-4	7.186E-4	1.221E-1
N° 12 (OFF)	---	3.980E-5	2.244E-4	4.897E-4	5.689E-2
N° 13 (OFF)	---	5.455E-5	2.878E-4	6.219E-4	7.546E-2
N° 14 (OFF)	---	6.418E-5	3.216E-4	6.685E-4	1.091E-1
N° 15 (OFF)	---	4.862E-5	2.691E-4	5.789E-4	5.575E-2
N° 16 (OFF)	---	4.382E-5	2.366E-4	5.064E-4	5.085E-2
Average (OFF)	---	4.060E-5	2.336E-4	5.062E-4	3.484E-2
σ (OFF)	---	1.176E-5	5.440E-5	8.380E-5	1.135E-2
Average+3σ (OFF)	---	7.589E-5	3.968E-4	7.576E-4	6.889E-2
Average-3σ (OFF)	---	5.305E-6	7.037E-5	2.548E-4	8.030E-4
Average (Bias1)	---	6.036E-5	3.345E-4	7.071E-4	1.110E-1
σ (Bias1)	---	8.422E-6	1.668E-5	3.642E-5	8.258E-3
Average+3σ (Bias1)	---	8.563E-5	3.845E-4	8.164E-4	1.358E-1
Average-3σ (Bias1)	---	3.510E-5	2.844E-4	5.979E-4	8.622E-2
Average (Bias2)	---	5.019E-5	2.679E-4	5.731E-4	6.962E-2
σ (Bias2)	---	9.564E-6	3.925E-5	7.571E-5	2.399E-2
Average+3σ (Bias2)	---	7.889E-5	3.857E-4	8.002E-4	1.416E-1
Average-3σ (Bias2)	---	2.150E-5	1.502E-4	3.459E-4	-2.366E-3

30 MeV proton / detailed results

3. Vce(sat)

Ta = 25°C ; IF = 1mA ; Ic = 2mA



30 MeV proton / detailed results

Vce(sat) . (V)

Max = 0.3

	0.p/cm ²	1.7E10.p/cm ²	8.5E10.p/cm ²	1.7E11.p/cm ²	1.7E12.p/cm ²
N° 1 (Ref)	0.168	0.173	0.172	0.169	0.170
N° 2 (Bias1)	0.167	0.181	0.224	0.278	Not Measurable*
N° 3 (Bias1)	0.167	0.182	0.228	0.295	Not Measurable*
N° 4 (Bias1)	0.154	0.165	0.200	0.241	Not Measurable*
N° 5 (Bias1)	0.164	0.176	0.221	0.282	Not Measurable*
N° 6 (Bias1)	0.163	0.175	0.219	0.271	Not Measurable*
N° 7 (Bias2)	0.167	0.185	0.271	0.350	Not Measurable*
N° 8 (Bias2)	0.167	0.184	0.262	0.375	Not Measurable*
N° 9 (Bias2)	0.164	0.187	0.246	0.370	Not Measurable*
N° 10 (Bias2)	0.166	0.196	0.295	0.452	Not Measurable*
N° 11 (Bias2)	0.166	0.195	0.245	0.339	Not Measurable*
N° 12 (OFF)	0.155	0.174	0.211	0.268	Not Measurable*
N° 13 (OFF)	0.162	0.179	0.228	0.315	Not Measurable*
N° 14 (OFF)	0.166	0.184	0.231	0.326	Not Measurable*
N° 15 (OFF)	0.163	0.180	0.225	0.300	Not Measurable*
N° 16 (OFF)	0.156	0.171	0.214	0.271	Not Measurable*

*Not measurable (test equipment limit)

Delta [Vce(sat)]

	0.p/cm ²	1.7E10.p/cm ²	8.5E10.p/cm ²	1.7E11.p/cm ²	1.7E12.p/cm ²
N° 1 (Ref)	---	5.000E-3	4.000E-3	1.000E-3	2.000E-3
N° 2 (Bias1)	---	1.400E-2	5.700E-2	1.110E-1	NaN
N° 3 (Bias1)	---	1.500E-2	6.100E-2	1.280E-1	NaN
N° 4 (Bias1)	---	1.100E-2	4.600E-2	8.700E-2	NaN
N° 5 (Bias1)	---	1.200E-2	5.700E-2	1.180E-1	NaN
N° 6 (Bias1)	---	1.200E-2	5.600E-2	1.080E-1	NaN
N° 7 (Bias2)	---	1.800E-2	1.040E-1	1.830E-1	NaN
N° 8 (Bias2)	---	1.700E-2	9.500E-2	2.080E-1	NaN
N° 9 (Bias2)	---	2.300E-2	8.200E-2	2.060E-1	NaN
N° 10 (Bias2)	---	3.000E-2	1.290E-1	2.860E-1	NaN
N° 11 (Bias2)	---	2.900E-2	7.900E-2	1.730E-1	NaN
N° 12 (OFF)	---	1.900E-2	5.600E-2	1.130E-1	NaN
N° 13 (OFF)	---	1.700E-2	6.600E-2	1.530E-1	NaN
N° 14 (OFF)	---	1.800E-2	6.500E-2	1.600E-1	NaN
N° 15 (OFF)	---	1.700E-2	6.200E-2	1.370E-1	NaN
N° 16 (OFF)	---	1.500E-2	5.800E-2	1.150E-1	NaN
Average (OFF)	---	1.280E-2	5.540E-2	1.104E-1	NaN
σ (OFF)	---	1.643E-3	5.595E-3	1.518E-2	0.000E+0
Average+3σ (OFF)	---	1.773E-2	7.218E-2	1.559E-1	NaN
Average-3σ (OFF)	---	7.870E-3	3.862E-2	6.487E-2	NaN
Average (Bias1)	---	2.340E-2	9.780E-2	2.112E-1	NaN
σ (Bias1)	---	6.025E-3	2.014E-2	4.440E-2	0.000E+0
Average+3σ (Bias1)	---	4.147E-2	1.582E-1	3.444E-1	NaN
Average-3σ (Bias1)	---	5.325E-3	3.737E-2	7.799E-2	NaN
Average (Bias2)	---	1.720E-2	6.140E-2	1.356E-1	NaN
σ (Bias2)	---	1.483E-3	4.336E-3	2.142E-2	0.000E+0
Average+3σ (Bias2)	---	2.165E-2	7.441E-2	1.999E-1	NaN
Average-3σ (Bias2)	---	1.275E-2	4.839E-2	7.134E-2	NaN

30 MeV proton / detailed results

4. BV_{ceo}

T_a = 25°C ; Ice = 1mA

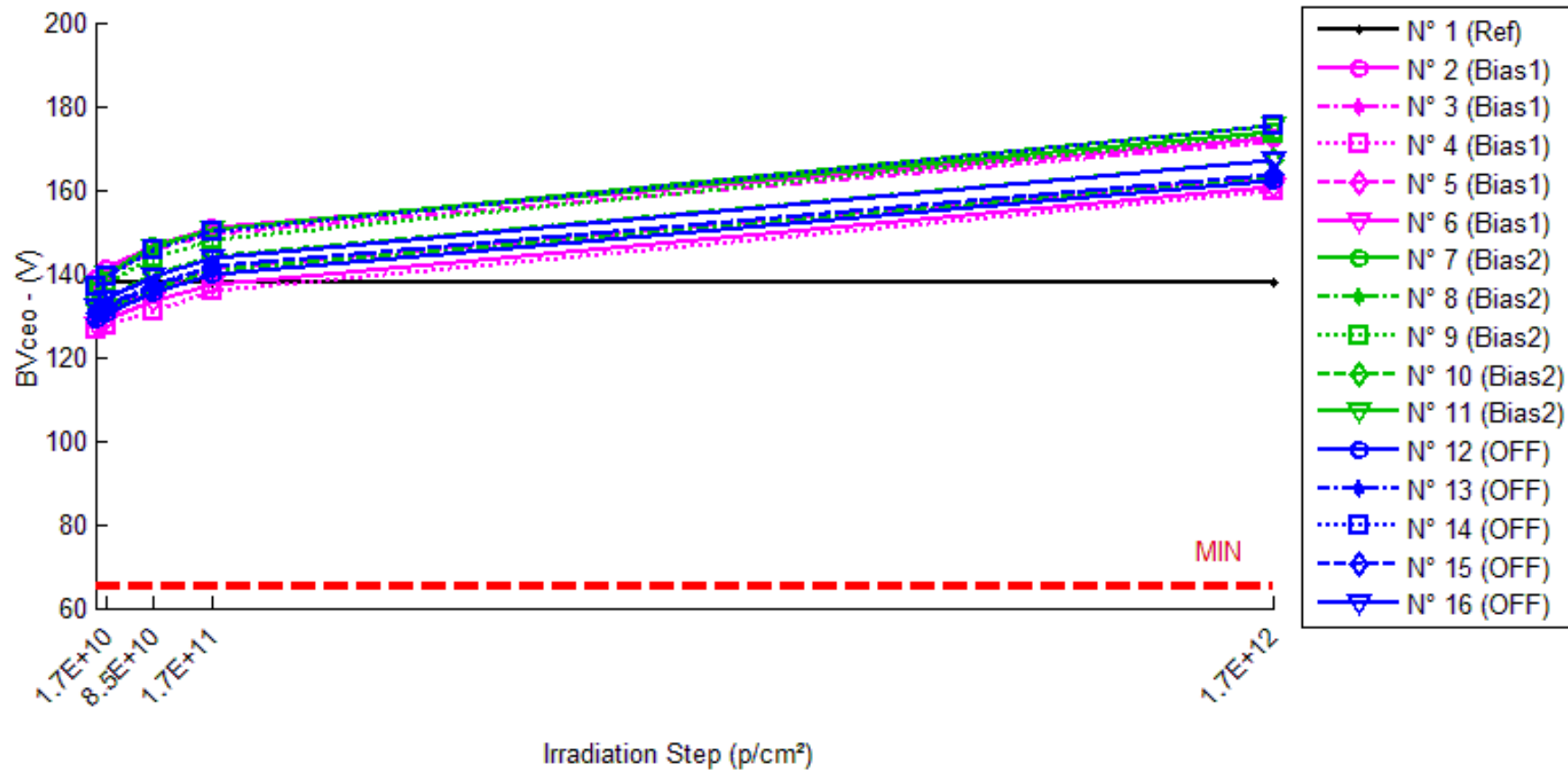

30 MeV proton / detailed results

BVceo . (V)

Min = 65.0

	0.p/cm ²	1.7E10.p/cm ²	8.5E10.p/cm ²	1.7E11.p/cm ²	1.7E12.p/cm ²
N° 1 (Ref)	137.6	137.8	137.7	137.6	137.7
N° 2 (Bias1)	139.0	141.2	146.8	150.8	172.4
N° 3 (Bias1)	137.4	139.7	145.5	149.4	171.4
N° 4 (Bias1)	126.6	127.4	131.2	135.8	159.7
N° 5 (Bias1)	130.6	131.9	136.3	141.0	163.4
N° 6 (Bias1)	127.7	128.8	133.3	137.5	160.8
N° 7 (Bias2)	137.3	139.7	146.4	150.3	173.7
N° 8 (Bias2)	129.7	131.1	136.3	140.8	162.8
N° 9 (Bias2)	135.4	137.6	143.8	147.9	173.2
N° 10 (Bias2)	132.5	134.1	139.7	144.2	167.2
N° 11 (Bias2)	137.1	139.9	146.1	150.3	175.6
N° 12 (OFF)	129.0	130.3	135.4	139.9	162.0
N° 13 (OFF)	131.0	132.4	137.2	141.8	163.7
N° 14 (OFF)	136.9	139.4	145.7	150.1	175.2
N° 15 (OFF)	130.5	131.8	137.0	141.5	163.9
N° 16 (OFF)	132.1	133.7	139.1	143.8	166.9

Delta [BVceo]

	0.p/cm ²	1.7E10.p/cm ²	8.5E10.p/cm ²	1.7E11.p/cm ²	1.7E12.p/cm ²
N° 1 (Ref)	---	1.822E-1	6.130E-2	5.000E-4	1.153E-1
N° 2 (Bias1)	---	2.157E+0	7.791E+0	1.172E+1	3.339E+1
N° 3 (Bias1)	---	2.293E+0	8.073E+0	1.202E+1	3.399E+1
N° 4 (Bias1)	---	8.418E-1	4.636E+0	9.200E+0	3.309E+1
N° 5 (Bias1)	---	1.293E+0	5.670E+0	1.041E+1	3.283E+1
N° 6 (Bias1)	---	1.172E+0	5.597E+0	9.819E+0	3.311E+1
N° 7 (Bias2)	---	2.363E+0	9.034E+0	1.294E+1	3.637E+1
N° 8 (Bias2)	---	1.346E+0	6.600E+0	1.112E+1	3.312E+1
N° 9 (Bias2)	---	2.190E+0	8.344E+0	1.250E+1	3.774E+1
N° 10 (Bias2)	---	1.648E+0	7.221E+0	1.170E+1	3.475E+1
N° 11 (Bias2)	---	2.804E+0	8.930E+0	1.313E+1	3.846E+1
N° 12 (OFF)	---	1.302E+0	6.412E+0	1.092E+1	3.298E+1
N° 13 (OFF)	---	1.367E+0	6.238E+0	1.077E+1	3.275E+1
N° 14 (OFF)	---	2.483E+0	8.853E+0	1.326E+1	3.831E+1
N° 15 (OFF)	---	1.366E+0	6.521E+0	1.098E+1	3.343E+1
N° 16 (OFF)	---	1.585E+0	7.067E+0	1.175E+1	3.482E+1
Average (OFF)	---	1.551E+0	6.353E+0	1.063E+1	3.328E+1
σ (OFF)	---	6.387E-1	1.501E+0	1.212E+0	4.431E-1
Average+3σ (OFF)	---	3.467E+0	1.086E+1	1.427E+1	3.461E+1
Average-3σ (OFF)	---	-3.647E-1	1.851E+0	6.998E+0	3.195E+1
Average (Bias1)	---	2.070E+0	8.026E+0	1.228E+1	3.609E+1
σ (Bias1)	---	5.792E-1	1.074E+0	8.488E-1	2.183E+0
Average+3σ (Bias1)	---	3.808E+0	1.125E+1	1.483E+1	4.264E+1
Average-3σ (Bias1)	---	3.324E-1	4.803E+0	9.734E+0	2.954E+1
Average (Bias2)	---	1.621E+0	7.018E+0	1.154E+1	3.446E+1
σ (Bias2)	---	4.940E-1	1.072E+0	1.038E+0	2.299E+0
Average+3σ (Bias2)	---	3.103E+0	1.023E+1	1.465E+1	4.135E+1
Average-3σ (Bias2)	---	1.389E-1	3.803E+0	8.421E+0	2.756E+1

30 MeV proton / detailed results

5. BVeco

Ta = 25°C ; Iec = 100μA

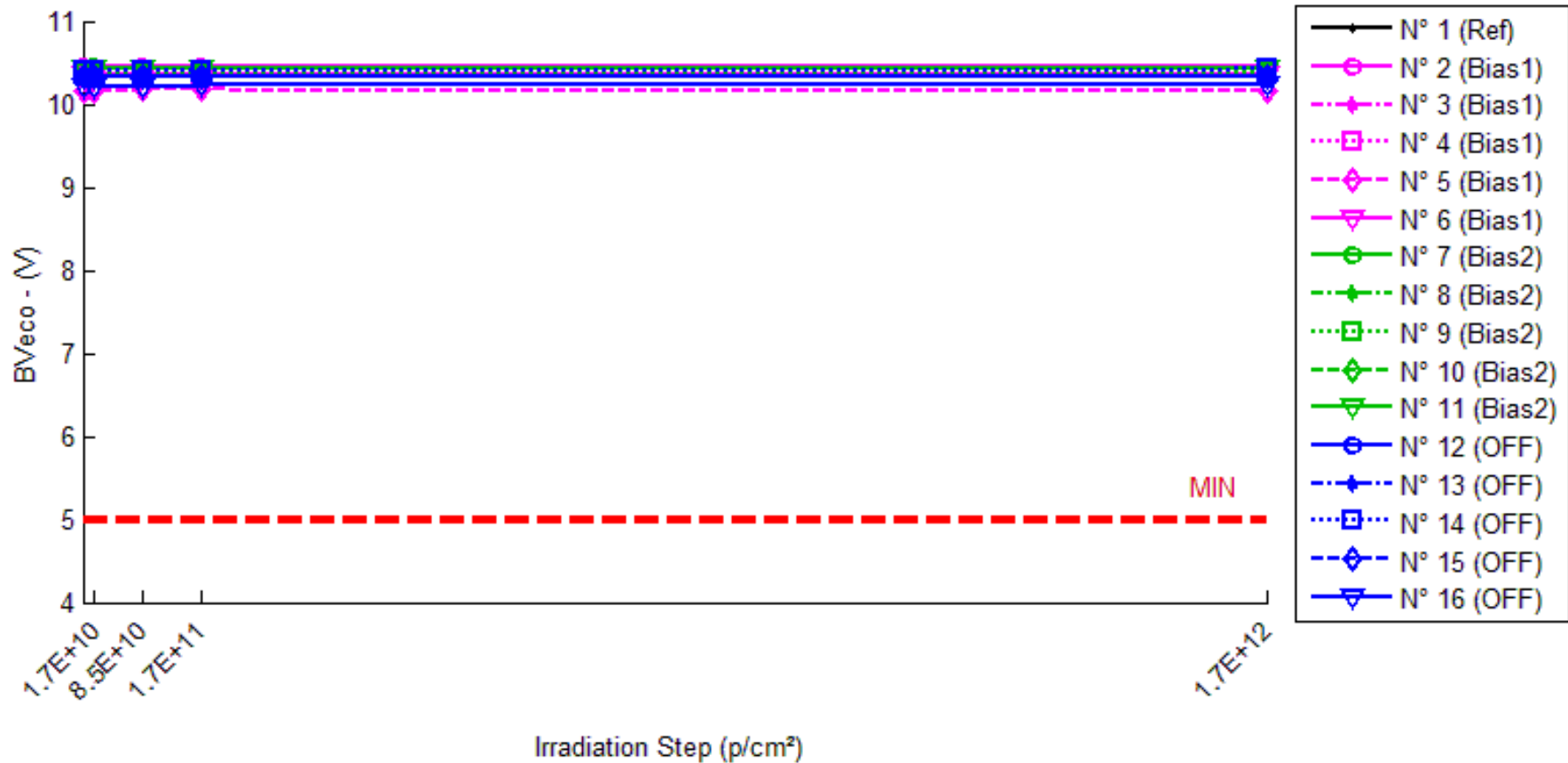

30 MeV proton / detailed results

BVeco . (V)

Min = 5.0

	0.p/cm ²	1.7E10.p/cm ²	8.5E10.p/cm ²	1.7E11.p/cm ²	1.7E12.p/cm ²
N° 1 (Ref)	10.433	10.449	10.439	10.435	10.439
N° 2 (Bias1)	10.449	10.446	10.448	10.444	10.448
N° 3 (Bias1)	10.428	10.423	10.425	10.421	10.418
N° 4 (Bias1)	10.360	10.352	10.360	10.358	10.354
N° 5 (Bias1)	10.165	10.165	10.183	10.180	10.162
N° 6 (Bias1)	10.345	10.343	10.348	10.346	10.356
N° 7 (Bias2)	10.432	10.445	10.436	10.428	10.435
N° 8 (Bias2)	10.337	10.340	10.338	10.338	10.326
N° 9 (Bias2)	10.389	10.389	10.389	10.382	10.383
N° 10 (Bias2)	10.332	10.331	10.332	10.332	10.318
N° 11 (Bias2)	10.427	10.427	10.426	10.423	10.427
N° 12 (OFF)	10.331	10.331	10.329	10.333	10.320
N° 13 (OFF)	10.330	10.329	10.328	10.332	10.325
N° 14 (OFF)	10.413	10.411	10.410	10.414	10.425
N° 15 (OFF)	10.328	10.329	10.329	10.328	10.322
N° 16 (OFF)	10.212	10.214	10.216	10.222	10.223

Delta [BVeco]

	0.p/cm ²	1.7E10.p/cm ²	8.5E10.p/cm ²	1.7E11.p/cm ²	1.7E12.p/cm ²
N° 1 (Ref)	---	1.580E-2	5.990E-3	1.790E-3	5.870E-3
N° 2 (Bias1)	---	-2.660E-3	-7.800E-4	-4.890E-3	-6.200E-4
N° 3 (Bias1)	---	-5.560E-3	-3.540E-3	-7.170E-3	-1.083E-2
N° 4 (Bias1)	---	-8.160E-3	2.000E-5	-1.650E-3	-5.520E-3
N° 5 (Bias1)	---	-1.100E-4	1.790E-2	1.444E-2	-2.840E-3
N° 6 (Bias1)	---	-1.580E-3	3.170E-3	1.150E-3	1.130E-2
N° 7 (Bias2)	---	1.285E-2	4.450E-3	-3.440E-3	3.650E-3
N° 8 (Bias2)	---	2.860E-3	1.090E-3	1.420E-3	-1.033E-2
N° 9 (Bias2)	---	-4.000E-4	-6.000E-4	-7.030E-3	-6.010E-3
N° 10 (Bias2)	---	-8.100E-4	1.800E-4	4.900E-4	-1.418E-2
N° 11 (Bias2)	---	1.900E-4	-1.470E-3	-4.000E-3	3.500E-4
N° 12 (OFF)	---	-3.700E-4	-1.980E-3	1.200E-3	-1.164E-2
N° 13 (OFF)	---	-1.440E-3	-2.140E-3	1.760E-3	-4.750E-3
N° 14 (OFF)	---	-2.560E-3	-3.110E-3	7.800E-4	1.185E-2
N° 15 (OFF)	---	1.150E-3	9.300E-4	7.000E-5	-6.780E-3
N° 16 (OFF)	---	2.210E-3	4.210E-3	9.620E-3	1.048E-2
Average (OFF)	---	-3.614E-3	3.354E-3	3.760E-4	-1.702E-3
σ (OFF)	---	3.232E-3	8.476E-3	8.473E-3	8.207E-3
Average+3 σ (OFF)	---	6.081E-3	2.878E-2	2.580E-2	2.292E-2
Average-3 σ (OFF)	---	-1.331E-2	-2.207E-2	-2.504E-2	-2.632E-2
Average (Bias1)	---	2.938E-3	7.300E-4	-2.512E-3	-5.304E-3
σ (Bias1)	---	5.723E-3	2.285E-3	3.463E-3	7.360E-3
Average+3 σ (Bias1)	---	2.011E-2	7.584E-3	7.876E-3	1.678E-2
Average-3 σ (Bias1)	---	-1.423E-2	-6.124E-3	-1.290E-2	-2.738E-2
Average (Bias2)	---	-2.020E-4	-4.180E-4	2.686E-3	-1.680E-4
σ (Bias2)	---	1.921E-3	2.995E-3	3.925E-3	1.066E-2
Average+3 σ (Bias2)	---	5.562E-3	8.568E-3	1.446E-2	3.180E-2
Average-3 σ (Bias2)	---	-5.966E-3	-9.404E-3	-9.089E-3	-3.213E-2

30 MeV proton / detailed results

6. Ice(off)

Ta = 25°C ; Vce = 20V

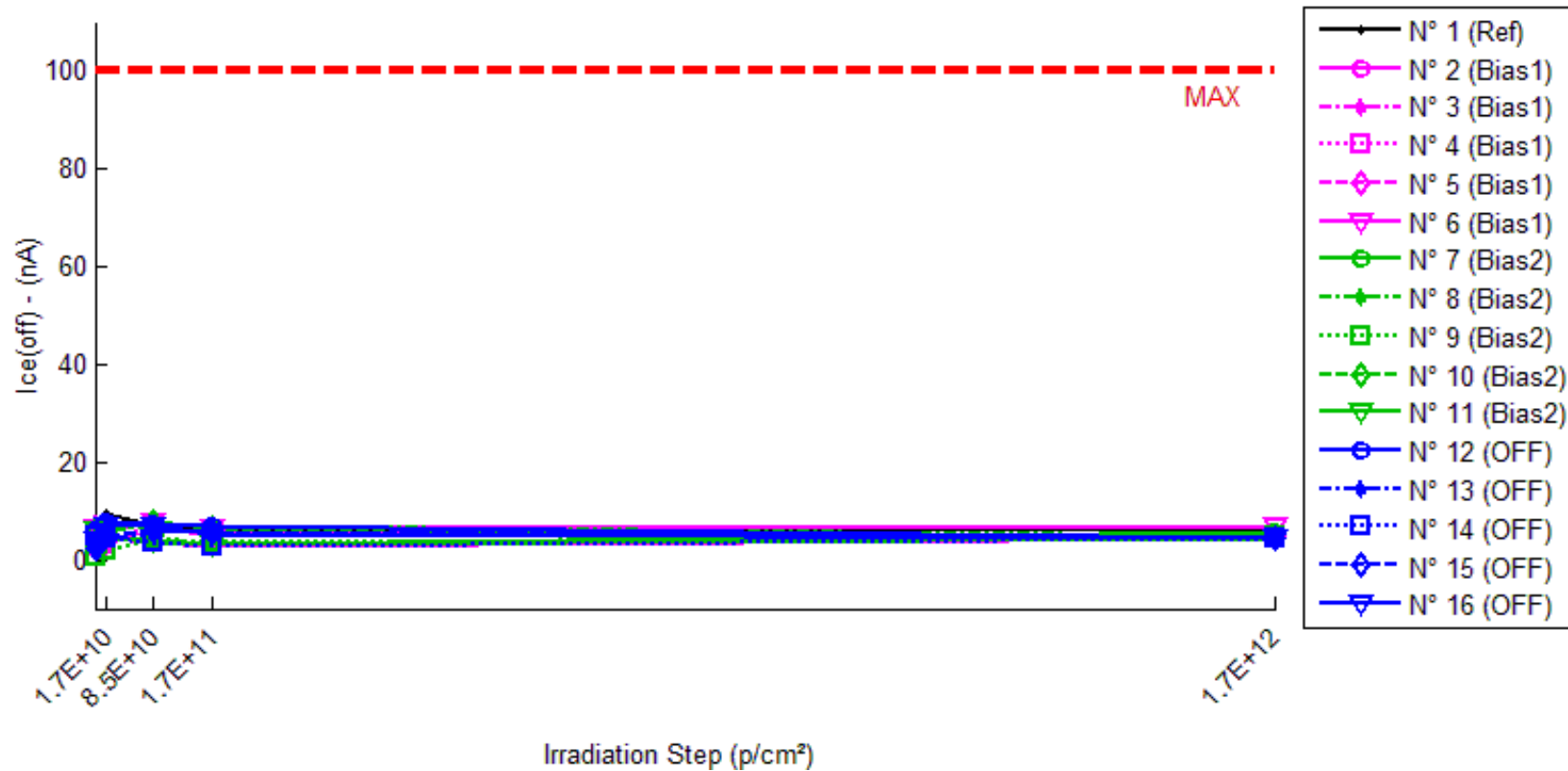

30 MeV proton / detailed results

Ice(off) . (nA)

Max = 100.0

	0.p/cm ²	1.7E10.p/cm ²	8.5E10.p/cm ²	1.7E11.p/cm ²	1.7E12.p/cm ²
N° 1 (Ref)	6.110	9.466	7.034	6.058	6.401
N° 2 (Bias1)	5.842	4.550	3.601	2.626	4.246
N° 3 (Bias1)	7.324	4.566	3.630	2.727	4.298
N° 4 (Bias1)	2.764	3.207	6.348	5.681	4.788
N° 5 (Bias1)	2.849	3.742	6.896	4.990	4.736
N° 6 (Bias1)	6.394	6.283	7.837	6.346	6.774
N° 7 (Bias2)	2.938	4.842	3.446	3.162	5.699
N° 8 (Bias2)	2.920	5.602	7.303	7.066	4.800
N° 9 (Bias2)	0.814	2.018	4.262	3.747	4.981
N° 10 (Bias2)	6.130	6.183	7.703	6.470	4.486
N° 11 (Bias2)	5.926	4.232	3.906	3.127	4.359
N° 12 (OFF)	6.040	7.588	7.433	7.108	4.579
N° 13 (OFF)	1.933	3.804	5.471	5.837	4.630
N° 14 (OFF)	4.908	4.346	3.448	2.914	4.432
N° 15 (OFF)	2.244	4.751	6.195	5.759	4.558
N° 16 (OFF)	4.122	6.861	6.995	5.425	4.481

Delta [Ice(off)]

	0.p/cm ²	1.7E10.p/cm ²	8.5E10.p/cm ²	1.7E11.p/cm ²	1.7E12.p/cm ²
N° 1 (Ref)	---	3.356E+0	9.240E-1	-5.254E-2	2.906E-1
N° 2 (Bias1)	---	-1.292E+0	-2.241E+0	-3.216E+0	-1.596E+0
N° 3 (Bias1)	---	-2.758E+0	-3.694E+0	-4.597E+0	-3.025E+0
N° 4 (Bias1)	---	4.430E-1	3.584E+0	2.916E+0	2.024E+0
N° 5 (Bias1)	---	8.934E-1	4.047E+0	2.141E+0	1.887E+0
N° 6 (Bias1)	---	-1.110E-1	1.443E+0	-4.835E-2	3.805E-1
N° 7 (Bias2)	---	1.904E+0	5.079E-1	2.234E-1	2.760E+0
N° 8 (Bias2)	---	2.682E+0	4.383E+0	4.146E+0	1.880E+0
N° 9 (Bias2)	---	1.204E+0	3.447E+0	2.933E+0	4.167E+0
N° 10 (Bias2)	---	5.258E-2	1.573E+0	3.397E-1	-1.644E+0
N° 11 (Bias2)	---	-1.694E+0	-2.020E+0	-2.799E+0	-1.567E+0
N° 12 (OFF)	---	1.548E+0	1.393E+0	1.067E+0	-1.461E+0
N° 13 (OFF)	---	1.871E+0	3.537E+0	3.904E+0	2.697E+0
N° 14 (OFF)	---	-5.624E-1	-1.461E+0	-1.994E+0	-4.761E-1
N° 15 (OFF)	---	2.507E+0	3.950E+0	3.515E+0	2.314E+0
N° 16 (OFF)	---	2.739E+0	2.873E+0	1.303E+0	3.591E-1
Average (OFF)	---	-5.649E-1	6.280E-1	-5.608E-1	-6.597E-2
σ (OFF)	---	1.474E+0	3.464E+0	3.279E+0	2.207E+0
Average+3σ (OFF)	---	3.856E+0	1.102E+1	9.275E+0	6.555E+0
Average-3σ (OFF)	---	-4.986E+0	-9.764E+0	-1.040E+1	-6.687E+0
Average (Bias1)	---	8.297E-1	1.578E+0	9.686E-1	1.119E+0
σ (Bias1)	---	1.710E+0	2.523E+0	2.697E+0	2.618E+0
Average+3σ (Bias1)	---	5.960E+0	9.147E+0	9.060E+0	8.973E+0
Average-3σ (Bias1)	---	-4.301E+0	-5.990E+0	-7.123E+0	-6.735E+0
Average (Bias2)	---	1.620E+0	2.059E+0	1.559E+0	6.865E-1
σ (Bias2)	---	1.310E+0	2.194E+0	2.359E+0	1.786E+0
Average+3σ (Bias2)	---	5.552E+0	8.641E+0	8.635E+0	6.045E+0

30 MeV proton / detailed results

7. VF

Ta = 25°C ; VF = 10mA

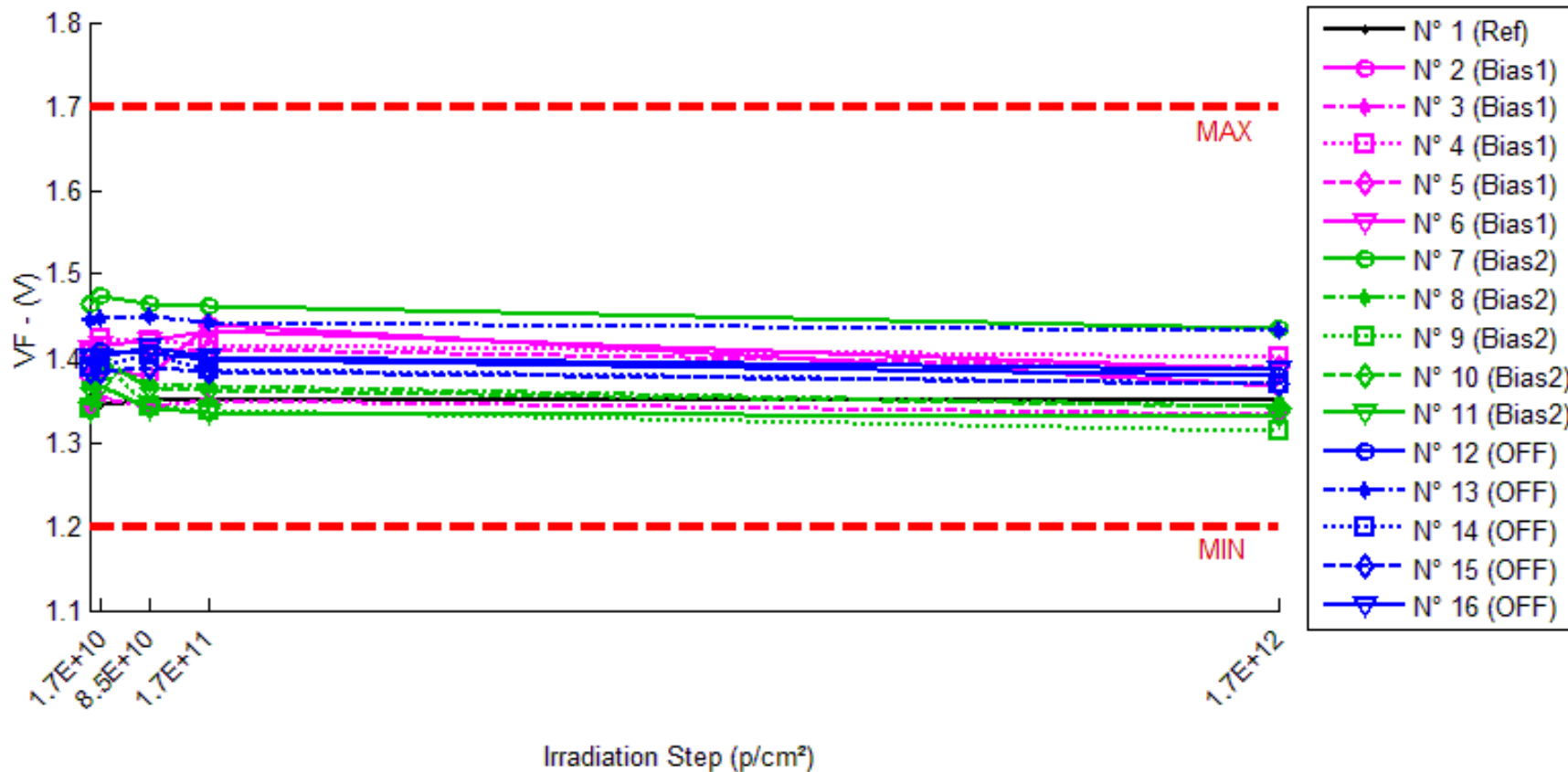

30 MeV proton / detailed results

VF . (V)

Min = 1.2 Max = 1.7

	0.p/cm ²	1.7E10.p/cm ²	8.5E10.p/cm ²	1.7E11.p/cm ²	1.7E12.p/cm ²
N° 1 (Ref)	1.352	1.346	1.349	1.351	1.349
N° 2 (Bias1)	1.378	1.387	1.380	1.441	1.367
N° 3 (Bias1)	1.341	1.353	1.343	1.349	1.334
N° 4 (Bias1)	1.406	1.422	1.420	1.417	1.402
N° 5 (Bias1)	1.401	1.407	1.409	1.410	1.390
N° 6 (Bias1)	1.411	1.415	1.420	1.433	1.387
N° 7 (Bias2)	1.464	1.475	1.465	1.462	1.436
N° 8 (Bias2)	1.370	1.395	1.369	1.366	1.342
N° 9 (Bias2)	1.340	1.396	1.342	1.338	1.313
N° 10 (Bias2)	1.364	1.399	1.365	1.361	1.342
N° 11 (Bias2)	1.337	1.366	1.340	1.336	1.330
N° 12 (OFF)	1.401	1.409	1.406	1.399	1.379
N° 13 (OFF)	1.445	1.448	1.450	1.443	1.434
N° 14 (OFF)	1.389	1.391	1.403	1.387	1.370
N° 15 (OFF)	1.384	1.385	1.389	1.383	1.369
N° 16 (OFF)	1.402	1.402	1.413	1.401	1.387

Delta [VF]

	0.p/cm ²	1.7E10.p/cm ²	8.5E10.p/cm ²	1.7E11.p/cm ²	1.7E12.p/cm ²
N° 1 (Ref)	---	-5.375E-3	-2.935E-3	-5.900E-4	-2.499E-3
N° 2 (Bias1)	---	8.442E-3	1.515E-3	6.277E-2	-1.153E-2
N° 3 (Bias1)	---	1.220E-2	2.782E-3	8.320E-3	-6.142E-3
N° 4 (Bias1)	---	1.600E-2	1.348E-2	1.126E-2	-3.989E-3
N° 5 (Bias1)	---	5.635E-3	7.221E-3	8.210E-3	-1.174E-2
N° 6 (Bias1)	---	4.077E-3	8.523E-3	2.116E-2	-2.390E-2
N° 7 (Bias2)	---	1.103E-2	1.229E-3	-2.537E-3	-2.843E-2
N° 8 (Bias2)	---	2.498E-2	-4.130E-4	-3.636E-3	-2.744E-2
N° 9 (Bias2)	---	5.591E-2	2.115E-3	-2.325E-3	-2.730E-2
N° 10 (Bias2)	---	3.550E-2	9.730E-4	-2.609E-3	-2.167E-2
N° 11 (Bias2)	---	2.825E-2	2.351E-3	-1.712E-3	-7.208E-3
N° 12 (OFF)	---	7.838E-3	5.064E-3	-1.293E-3	-2.138E-2
N° 13 (OFF)	---	3.381E-3	4.921E-3	-1.816E-3	-1.069E-2
N° 14 (OFF)	---	1.694E-3	1.349E-2	-1.839E-3	-1.862E-2
N° 15 (OFF)	---	1.118E-3	5.131E-3	-1.266E-3	-1.493E-2
N° 16 (OFF)	---	3.920E-4	1.121E-2	-9.000E-4	-1.513E-2
Average (OFF)	---	9.271E-3	6.705E-3	2.234E-2	-1.146E-2
σ (OFF)	---	4.867E-3	4.792E-3	2.321E-2	7.727E-3
Average+3σ (OFF)	---	2.387E-2	2.108E-2	9.198E-2	1.172E-2
Average-3σ (OFF)	---	-5.330E-3	-7.672E-3	-4.729E-2	-3.464E-2
Average (Bias1)	---	3.114E-2	1.251E-3	-2.564E-3	-2.241E-2
σ (Bias1)	---	1.646E-2	1.096E-3	6.955E-4	8.903E-3
Average+3σ (Bias1)	---	8.050E-2	4.538E-3	-4.773E-4	4.301E-3
Average-3σ (Bias1)	---	-1.823E-2	-2.036E-3	-4.650E-3	-4.912E-2
Average (Bias2)	---	2.885E-3	7.962E-3	-1.423E-3	-1.615E-2
σ (Bias2)	---	2.981E-3	4.085E-3	4.008E-4	4.056E-3
Average+3σ (Bias2)	---	1.183E-2	2.022E-2	-2.204E-4	-3.985E-3
Average-3σ (Bias2)	---	-6.057E-3	-4.292E-3	-2.625E-3	-2.832E-2

30 MeV proton / detailed results

8. Ir

Ta = 25°C ; Vr = 2V

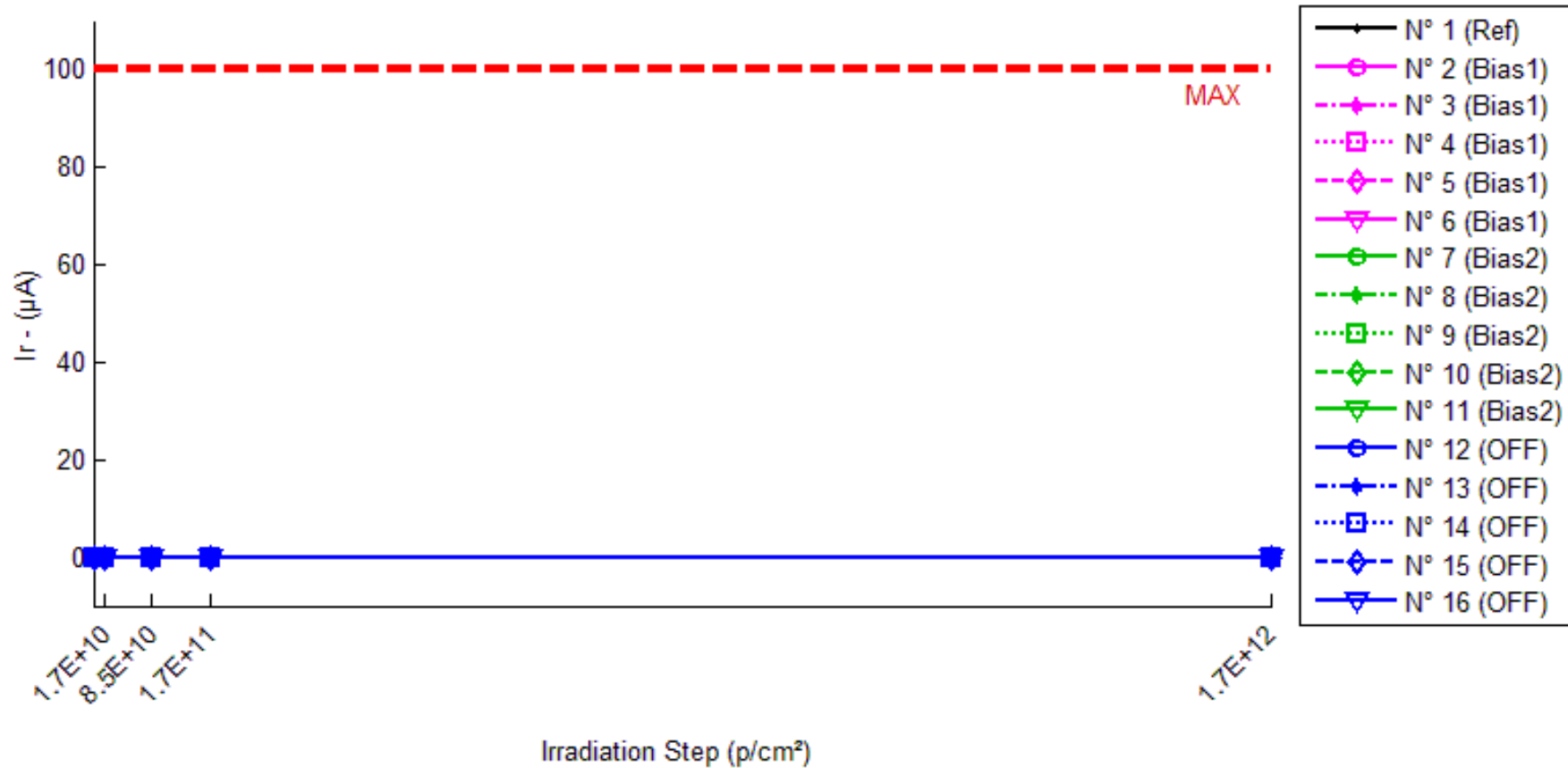

30 MeV proton / detailed results

Ir . (µA)

Max = 100.0

	0.p/cm ²	1.7E10.p/cm ²	8.5E10.p/cm ²	1.7E11.p/cm ²	1.7E12.p/cm ²
N° 1 (Ref)	1.488E-6	2.445E-5	2.190E-5	1.339E-5	1.678E-5
N° 2 (Bias1)	2.871E-6	1.460E-5	1.456E-5	1.435E-5	3.160E-7
N° 3 (Bias1)	1.656E-6	1.528E-5	1.833E-5	2.102E-5	4.213E-6
N° 4 (Bias1)	4.038E-5	1.121E-5	1.414E-5	1.075E-5	1.134E-5
N° 5 (Bias1)	2.242E-6	1.025E-5	1.666E-5	1.196E-5	1.068E-6
N° 6 (Bias1)	1.027E-6	9.953E-6	1.276E-5	9.869E-6	6.516E-6
N° 7 (Bias2)	4.464E-6	4.281E-5	3.539E-5	3.556E-5	1.792E-5
N° 8 (Bias2)	1.758E-5	2.269E-5	1.947E-5	2.206E-5	2.330E-7
N° 9 (Bias2)	1.153E-6	1.980E-5	2.165E-5	1.641E-5	1.783E-6
N° 10 (Bias2)	1.146E-5	1.134E-5	1.347E-5	1.913E-5	1.570E-5
N° 11 (Bias2)	1.702E-4	1.541E-4	1.369E-4	1.567E-4	1.485E-4
N° 12 (OFF)	1.470E-7	1.762E-5	1.913E-5	1.020E-5	2.705E-6
N° 13 (OFF)	4.170E-6	2.148E-5	1.922E-5	8.234E-6	1.787E-5
N° 14 (OFF)	8.236E-6	1.599E-5	1.972E-5	2.081E-5	1.875E-5
N° 15 (OFF)	1.781E-6	1.595E-5	2.173E-5	1.863E-5	3.288E-6
N° 16 (OFF)	3.793E-6	2.751E-5	1.922E-5	1.741E-5	7.354E-6

Delta [Ir]

	0.p/cm ²	1.7E10.p/cm ²	8.5E10.p/cm ²	1.7E11.p/cm ²	1.7E12.p/cm ²
N° 1 (Ref)	---	2.297E-5	2.041E-5	1.190E-5	1.530E-5
N° 2 (Bias1)	---	1.173E-5	1.169E-5	1.148E-5	-2.555E-6
N° 3 (Bias1)	---	1.362E-5	1.668E-5	1.936E-5	2.557E-6
N° 4 (Bias1)	---	-2.917E-5	-2.624E-5	-2.963E-5	-2.904E-5
N° 5 (Bias1)	---	8.005E-6	1.442E-5	9.723E-6	-1.174E-6
N° 6 (Bias1)	---	8.926E-6	1.173E-5	8.842E-6	5.489E-6
N° 7 (Bias2)	---	3.835E-5	3.093E-5	3.110E-5	1.345E-5
N° 8 (Bias2)	---	5.111E-6	1.884E-6	4.482E-6	-1.735E-5
N° 9 (Bias2)	---	1.865E-5	2.049E-5	1.525E-5	6.300E-7
N° 10 (Bias2)	---	-1.280E-7	2.010E-6	7.668E-6	4.235E-6
N° 11 (Bias2)	---	-1.609E-5	-3.328E-5	-1.350E-5	-2.175E-5
N° 12 (OFF)	---	1.747E-5	1.898E-5	1.006E-5	2.558E-6
N° 13 (OFF)	---	1.731E-5	1.505E-5	4.064E-6	1.370E-5
N° 14 (OFF)	---	7.752E-6	1.148E-5	1.257E-5	1.052E-5
N° 15 (OFF)	---	1.416E-5	1.995E-5	1.685E-5	1.507E-6
N° 16 (OFF)	---	2.372E-5	1.542E-5	1.362E-5	3.561E-6
Average (OFF)	---	2.623E-6	5.657E-6	3.955E-6	-4.945E-6
σ (OFF)	---	1.791E-5	1.795E-5	1.923E-5	1.384E-5
Average+3σ (OFF)	---	5.636E-5	5.951E-5	6.165E-5	3.657E-5
Average-3σ (OFF)	---	-5.112E-5	-4.819E-5	-5.374E-5	-4.646E-5
Average (Bias1)	---	9.177E-6	4.407E-6	9.000E-6	-4.157E-6
σ (Bias1)	---	2.051E-5	2.447E-5	1.625E-5	1.489E-5
Average+3σ (Bias1)	---	7.070E-5	7.781E-5	5.774E-5	4.052E-5
Average-3σ (Bias1)	---	-5.235E-5	-6.899E-5	-3.974E-5	-4.883E-5
Average (Bias2)	---	1.608E-5	1.618E-5	1.143E-5	6.369E-6
σ (Bias2)	---	5.806E-6	3.391E-6	4.785E-6	5.409E-6
Average+3σ (Bias2)	---	3.350E-5	2.635E-5	2.579E-5	2.260E-5
Average-3σ (Bias2)	---	-1.335E-6	6.003E-6	-2.923E-6	-9.859E-6

30 MeV proton / detailed results

9. TR

Ta = 25°C ; Vcc = 10V ; RL = 100 Ohms ; IF = 5mA

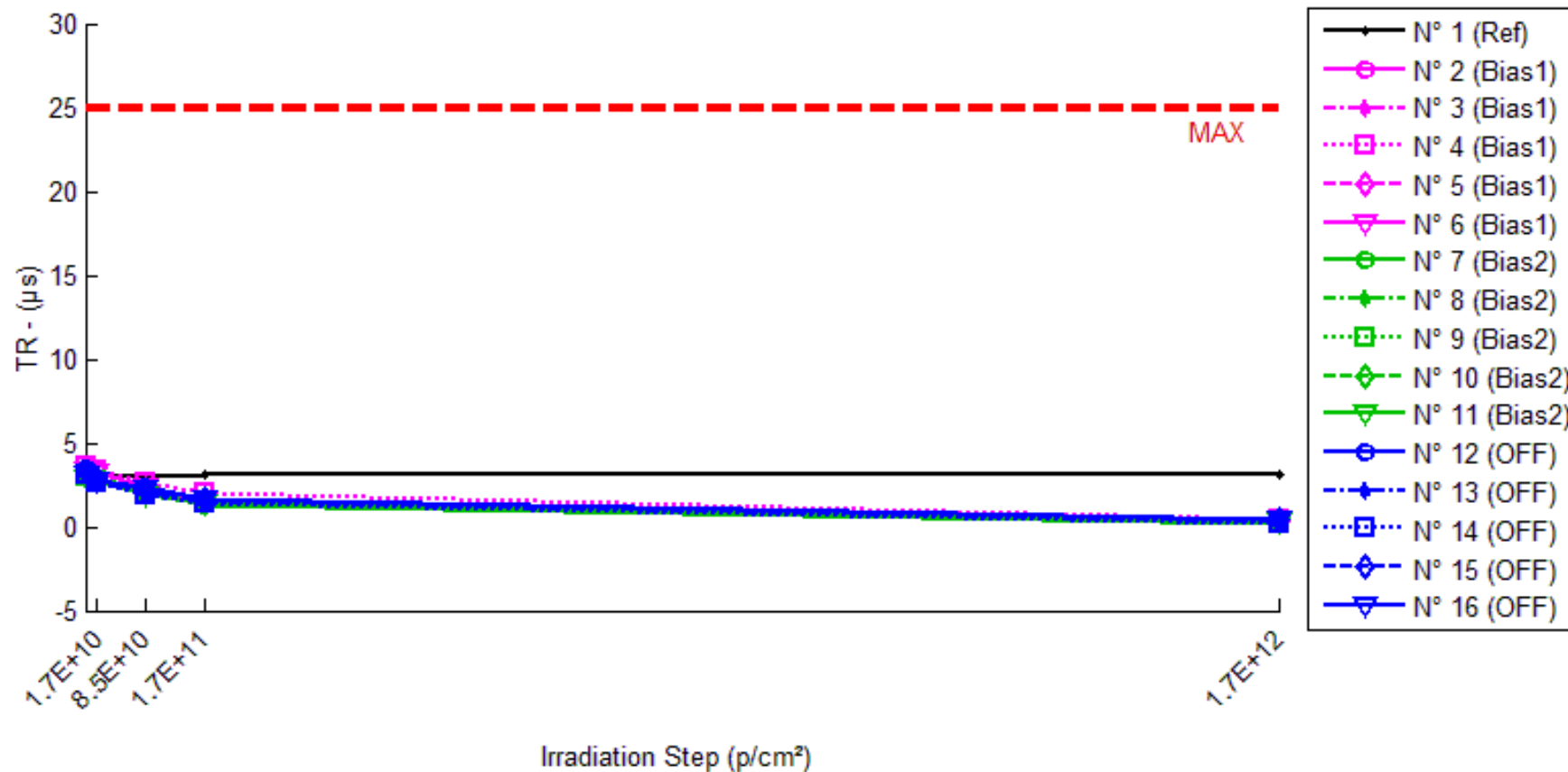

30 MeV proton / detailed results

TR . (μs)

Max = 20.0

	0.p/cm ²	1.7E10.p/cm ²	8.5E10.p/cm ²	1.7E11.p/cm ²	1.7E12.p/cm ²
N° 1 (Ref)	3.0	3.1	3.0	3.1	3.1
N° 2 (Bias1)	3.1	2.8	2.1	1.6	0.2
N° 3 (Bias1)	3.1	2.8	2.0	1.4	0.3
N° 4 (Bias1)	3.6	3.4	2.6	2.0	0.4
N° 5 (Bias1)	3.1	2.8	2.2	1.6	0.3
N° 6 (Bias1)	3.3	3.2	2.4	1.7	0.3
N° 7 (Bias2)	3.0	2.8	2.1	1.3	0.2
N° 8 (Bias2)	3.1	2.9	2.2	1.5	0.4
N° 9 (Bias2)	3.0	2.7	2.0	1.4	0.3
N° 10 (Bias2)	3.1	2.9	2.1	1.6	0.4
N° 11 (Bias2)	2.9	2.7	1.9	1.4	0.3
N° 12 (OFF)	3.5	2.7	2.4	1.7	0.4
N° 13 (OFF)	3.0	2.8	2.0	1.5	0.3
N° 14 (OFF)	3.1	2.6	1.9	1.4	0.2
N° 15 (OFF)	3.2	2.9	2.1	1.6	0.4
N° 16 (OFF)	3.1	2.8	2.2	1.6	0.4

Delta [TR]

	0.p/cm ²	1.7E10.p/cm ²	8.5E10.p/cm ²	1.7E11.p/cm ²	1.7E12.p/cm ²
N° 1 (Ref)	---	1.000E-1	0.000E+0	1.000E-1	1.000E-1
N° 2 (Bias1)	---	-3.000E-1	-1.000E+0	-1.500E+0	-2.900E+0
N° 3 (Bias1)	---	-3.000E-1	-1.100E+0	-1.700E+0	-2.800E+0
N° 4 (Bias1)	---	-2.000E-1	-1.000E+0	-1.600E+0	-3.200E+0
N° 5 (Bias1)	---	-3.000E-1	-9.000E-1	-1.500E+0	-2.800E+0
N° 6 (Bias1)	---	-1.000E-1	-9.000E-1	-1.600E+0	-3.000E+0
N° 7 (Bias2)	---	-2.000E-1	-9.000E-1	-1.700E+0	-2.800E+0
N° 8 (Bias2)	---	-2.000E-1	-9.000E-1	-1.600E+0	-2.700E+0
N° 9 (Bias2)	---	-3.000E-1	-1.000E+0	-1.600E+0	-2.700E+0
N° 10 (Bias2)	---	-2.000E-1	-1.000E+0	-1.500E+0	-2.700E+0
N° 11 (Bias2)	---	-2.000E-1	-1.000E+0	-1.500E+0	-2.600E+0
N° 12 (OFF)	---	-8.000E-1	-1.100E+0	-1.800E+0	-3.100E+0
N° 13 (OFF)	---	-2.000E-1	-1.000E+0	-1.500E+0	-2.700E+0
N° 14 (OFF)	---	-5.000E-1	-1.200E+0	-1.700E+0	-2.900E+0
N° 15 (OFF)	---	-3.000E-1	-1.100E+0	-1.600E+0	-2.800E+0
N° 16 (OFF)	---	-3.000E-1	-9.000E-1	-1.500E+0	-2.700E+0
Average (OFF)	---	-2.400E-1	-9.800E-1	-1.580E+0	-2.940E+0
σ (OFF)	---	8.944E-2	8.367E-2	8.367E-2	1.673E-1
Average+3σ (OFF)	---	2.833E-2	-7.290E-1	-1.329E+0	-2.438E+0
Average-3σ (OFF)	---	-5.083E-1	-1.231E+0	-1.831E+0	-3.442E+0
Average (Bias1)	---	-2.200E-1	-9.600E-1	-1.580E+0	-2.700E+0
σ (Bias1)	---	4.472E-2	5.477E-2	8.367E-2	7.071E-2
Average+3σ (Bias1)	---	-8.584E-2	-7.957E-1	-1.329E+0	-2.488E+0
Average-3σ (Bias1)	---	-3.542E-1	-1.124E+0	-1.831E+0	-2.912E+0
Average (Bias2)	---	-4.200E-1	-1.060E+0	-1.620E+0	-2.840E+0
σ (Bias2)	---	2.387E-1	1.140E-1	1.304E-1	1.673E-1
Average+3σ (Bias2)	---	2.962E-1	-7.179E-1	-1.229E+0	-2.338E+0
Average-3σ (Bias2)	---	-1.136E+0	-1.402E+0	-2.011E+0	-3.342E+0

30 MeV proton / detailed results

10.TF

Ta = 25°C ; Vcc = 10V ; RL = 100 Ohms ; IF = 5mA

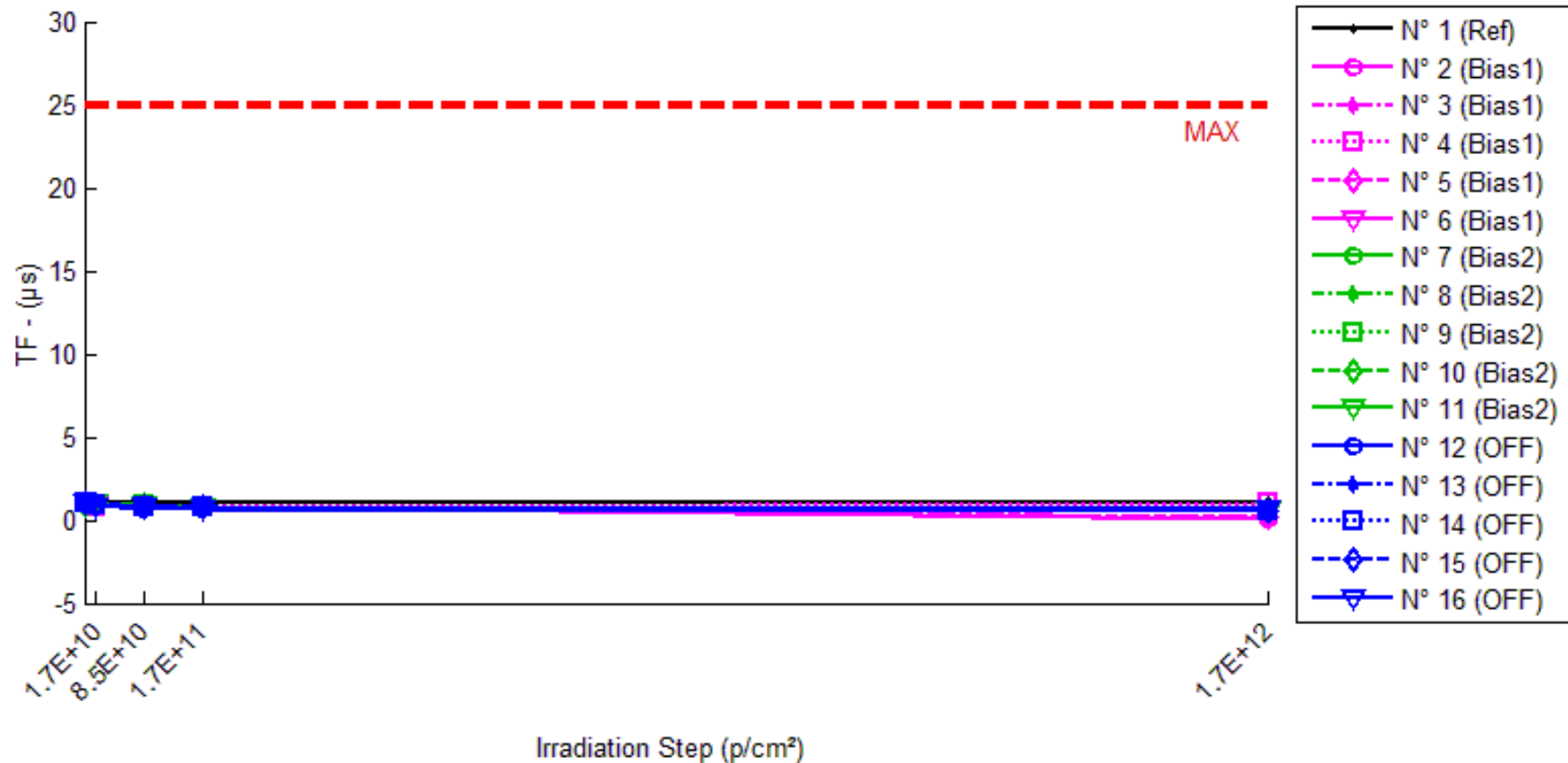

30 MeV proton / detailed results

TF . (µs)

Max = 20.0

	0.p/cm ²	1.7E10.p/cm ²	8.5E10.p/cm ²	1.7E11.p/cm ²	1.7E12.p/cm ²
N° 1 (Ref)	1.0	1.1	1.0	1.0	1.1
N° 2 (Bias1)	1.2	1.0	0.8	0.8	0.1
N° 3 (Bias1)	1.1	1.0	0.8	0.8	0.2
N° 4 (Bias1)	1.0	0.8	0.8	0.8	1.0
N° 5 (Bias1)	1.0	0.9	0.8	0.8	0.2
N° 6 (Bias1)	1.0	0.9	0.8	0.8	0.6
N° 7 (Bias2)	1.1	0.9	0.9	0.8	0.6
N° 8 (Bias2)	1.0	0.9	0.8	0.8	0.6
N° 9 (Bias2)	1.0	0.9	0.9	0.8	0.6
N° 10 (Bias2)	0.9	0.9	0.9	0.8	0.6
N° 11 (Bias2)	1.0	1.0	0.9	0.8	0.5
N° 12 (OFF)	1.0	0.9	0.7	0.7	0.6
N° 13 (OFF)	0.9	1.0	0.8	0.8	0.6
N° 14 (OFF)	1.0	0.9	0.8	0.8	0.6
N° 15 (OFF)	1.0	0.9	0.8	0.8	0.6
N° 16 (OFF)	1.0	0.8	0.8	0.7	0.7

Delta [TF]

	0.p/cm ²	1.7E10.p/cm ²	8.5E10.p/cm ²	1.7E11.p/cm ²	1.7E12.p/cm ²
N° 1 (Ref)	---	1.000E-1	0.000E+0	0.000E+0	1.000E-1
N° 2 (Bias1)	---	-2.000E-1	-4.000E-1	-4.000E-1	-1.100E+0
N° 3 (Bias1)	---	-1.000E-1	-3.000E-1	-3.000E-1	-9.000E-1
N° 4 (Bias1)	---	-2.000E-1	-2.000E-1	-2.000E-1	0.000E+0
N° 5 (Bias1)	---	-1.000E-1	-2.000E-1	-2.000E-1	-8.000E-1
N° 6 (Bias1)	---	-1.000E-1	-2.000E-1	-2.000E-1	-4.000E-1
N° 7 (Bias2)	---	-2.000E-1	-2.000E-1	-3.000E-1	-5.000E-1
N° 8 (Bias2)	---	-1.000E-1	-2.000E-1	-2.000E-1	-4.000E-1
N° 9 (Bias2)	---	-1.000E-1	-1.000E-1	-2.000E-1	-4.000E-1
N° 10 (Bias2)	---	0.000E+0	0.000E+0	-1.000E-1	-3.000E-1
N° 11 (Bias2)	---	0.000E+0	-1.000E-1	-2.000E-1	-5.000E-1
N° 12 (OFF)	---	-1.000E-1	-3.000E-1	-3.000E-1	-4.000E-1
N° 13 (OFF)	---	1.000E-1	-1.000E-1	-1.000E-1	-3.000E-1
N° 14 (OFF)	---	-1.000E-1	-2.000E-1	-2.000E-1	-4.000E-1
N° 15 (OFF)	---	-1.000E-1	-2.000E-1	-2.000E-1	-4.000E-1
N° 16 (OFF)	---	-2.000E-1	-2.000E-1	-3.000E-1	-3.000E-1
Average (OFF)	---	-1.400E-1	-2.600E-1	-2.600E-1	-6.400E-1
σ (OFF)	---	5.477E-2	8.944E-2	8.944E-2	4.393E-1
Average+3σ (OFF)	---	2.432E-2	8.328E-3	8.328E-3	6.780E-1
Average-3σ (OFF)	---	-3.043E-1	-5.283E-1	-5.283E-1	-1.958E+0
Average (Bias1)	---	-8.000E-2	-1.200E-1	-2.000E-1	-4.200E-1
σ (Bias1)	---	8.367E-2	8.367E-2	7.071E-2	8.367E-2
Average+3σ (Bias1)	---	1.710E-1	1.310E-1	1.213E-2	-1.690E-1
Average-3σ (Bias1)	---	-3.310E-1	-3.710E-1	-4.121E-1	-6.710E-1
Average (Bias2)	---	-8.000E-2	-2.000E-1	-2.200E-1	-3.600E-1
σ (Bias2)	---	1.095E-1	7.071E-2	8.367E-2	5.477E-2
Average+3σ (Bias2)	---	2.486E-1	1.213E-2	3.100E-2	-1.957E-1
Average-3σ (Bias2)	---	-4.086E-1	-4.121E-1	-4.710E-1	-5.243E-1

30 MeV proton / detailed results

11.CTR2

Ta = 25°C ; IF = 2mA ; Vce = 5V

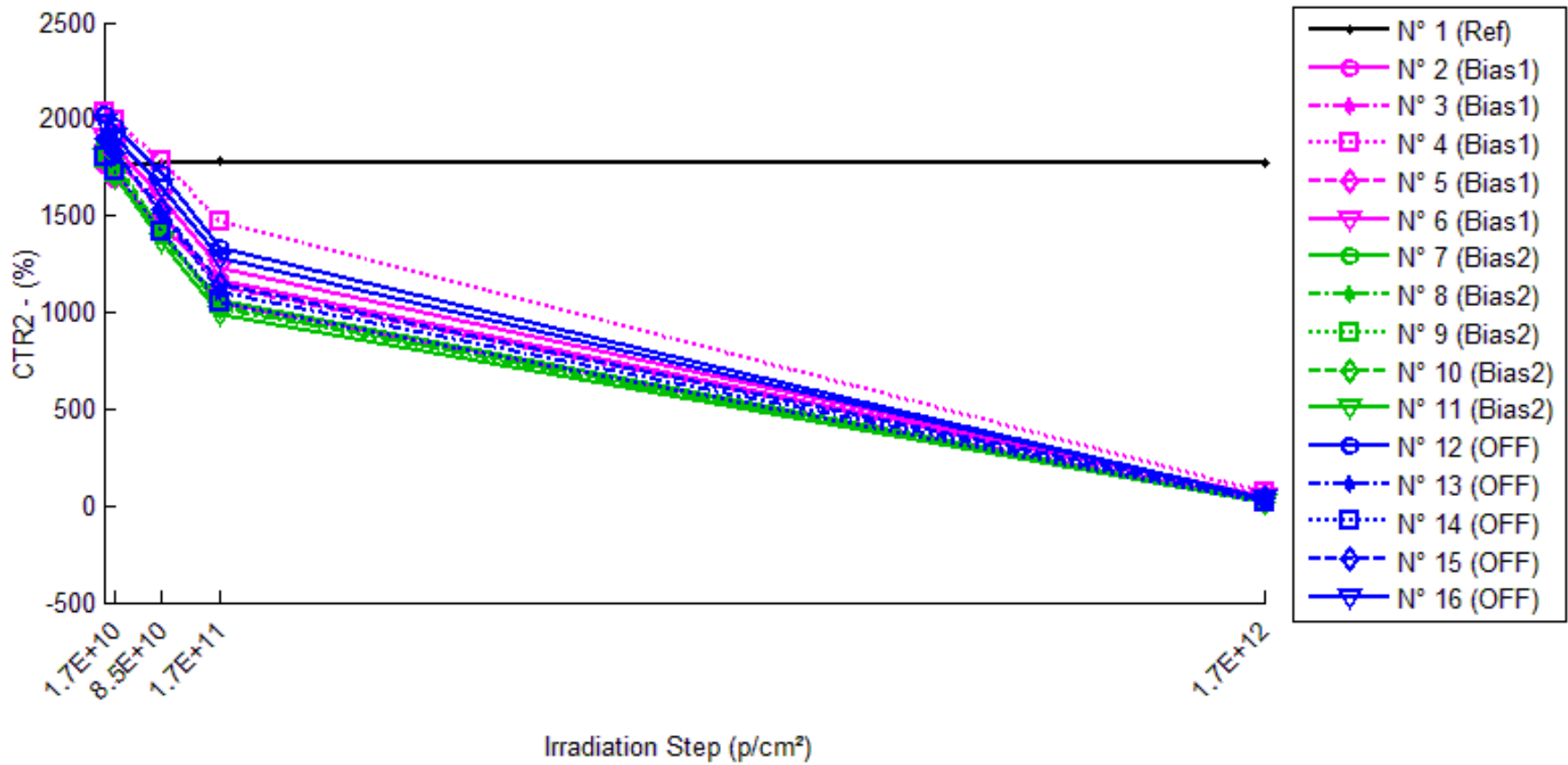

30 MeV proton / detailed results

CTR2 . (%)

	0.p/cm ²	1.7E10.p/cm ²	8.5E10.p/cm ²	1.7E11.p/cm ²	1.7E12.p/cm ²
N° 1 (Ref)	1782.18	1759.49	1772.80	1779.54	1776.14
N° 2 (Bias1)	1758.63	1686.40	1452.76	1164.72	44.42
N° 3 (Bias1)	1787.17	1712.40	1407.88	1054.40	30.11
N° 4 (Bias1)	2036.68	1993.43	1788.94	1471.87	70.44
N° 5 (Bias1)	1871.03	1813.02	1517.35	1139.03	43.85
N° 6 (Bias1)	1909.67	1855.24	1593.16	1227.86	53.33
N° 7 (Bias2)	1808.13	1711.57	1395.65	1061.42	18.77
N° 8 (Bias2)	1867.45	1793.55	1421.26	1020.11	18.99
N° 9 (Bias2)	1797.90	1716.46	1413.09	1043.49	17.97
N° 10 (Bias2)	1848.09	1758.97	1421.99	1033.53	19.44
N° 11 (Bias2)	1800.97	1695.64	1363.00	986.00	14.36
N° 12 (OFF)	2028.24	1963.06	1725.60	1339.38	33.43
N° 13 (OFF)	1898.31	1827.52	1508.74	1102.63	23.45
N° 14 (OFF)	1807.97	1727.20	1420.32	1051.69	19.67
N° 15 (OFF)	1897.97	1830.41	1537.39	1150.52	33.52
N° 16 (OFF)	1978.53	1906.35	1652.21	1285.34	36.83

1/Delta [CTR2]

	0.p/cm ²	1.7E10.p/cm ²	8.5E10.p/cm ²	1.7E11.p/cm ²	1.7E12.p/cm ²
N° 1 (Ref)	---	7.233E-6	2.969E-6	8.302E-7	1.906E-6
N° 2 (Bias1)	---	2.436E-5	1.197E-4	2.899E-4	2.194E-2
N° 3 (Bias1)	---	2.443E-5	1.507E-4	3.889E-4	3.265E-2
N° 4 (Bias1)	---	1.065E-5	6.799E-5	1.884E-4	1.371E-2
N° 5 (Bias1)	---	1.710E-5	1.246E-4	3.435E-4	2.227E-2
N° 6 (Bias1)	---	1.536E-5	1.040E-4	2.908E-4	1.823E-2
N° 7 (Bias2)	---	3.120E-5	1.635E-4	3.891E-4	5.272E-2
N° 8 (Bias2)	---	2.206E-5	1.681E-4	4.448E-4	5.214E-2
N° 9 (Bias2)	---	2.639E-5	1.515E-4	4.021E-4	5.511E-2
N° 10 (Bias2)	---	2.742E-5	1.621E-4	4.265E-4	5.090E-2
N° 11 (Bias2)	---	3.449E-5	1.784E-4	4.589E-4	6.906E-2
N° 12 (OFF)	---	1.637E-5	8.647E-5	2.536E-4	2.942E-2
N° 13 (OFF)	---	2.040E-5	1.360E-4	3.801E-4	4.211E-2
N° 14 (OFF)	---	2.587E-5	1.510E-4	3.977E-4	5.029E-2
N° 15 (OFF)	---	1.944E-5	1.236E-4	3.423E-4	2.930E-2
N° 16 (OFF)	---	1.914E-5	9.983E-5	2.726E-4	2.664E-2
Average (OFF)	---	1.838E-5	1.134E-4	3.003E-4	2.176E-2
σ (OFF)	---	5.974E-6	3.045E-5	7.487E-5	7.004E-3
Average+3σ (OFF)	---	3.630E-5	2.048E-4	5.249E-4	4.277E-2
Average-3σ (OFF)	---	4.584E-7	2.206E-5	7.567E-5	7.481E-4
Average (Bias1)	---	2.831E-5	1.647E-4	4.243E-4	5.598E-2
σ (Bias1)	---	4.746E-6	9.786E-6	2.897E-5	7.467E-3
Average+3σ (Bias1)	---	4.255E-5	1.941E-4	5.112E-4	7.839E-2
Average-3σ (Bias1)	---	1.407E-5	1.354E-4	3.374E-4	3.358E-2
Average (Bias2)	---	2.025E-5	1.194E-4	3.293E-4	3.555E-2
σ (Bias2)	---	3.482E-6	2.625E-5	6.401E-5	1.020E-2
Average+3σ (Bias2)	---	3.069E-5	1.981E-4	5.213E-4	6.615E-2
Average-3σ (Bias2)	---	9.798E-6	4.061E-5	1.372E-4	4.955E-3

30 MeV proton / detailed results

12.CTR3

Ta = 25°C ; IF = 10mA ; Vce = 5V

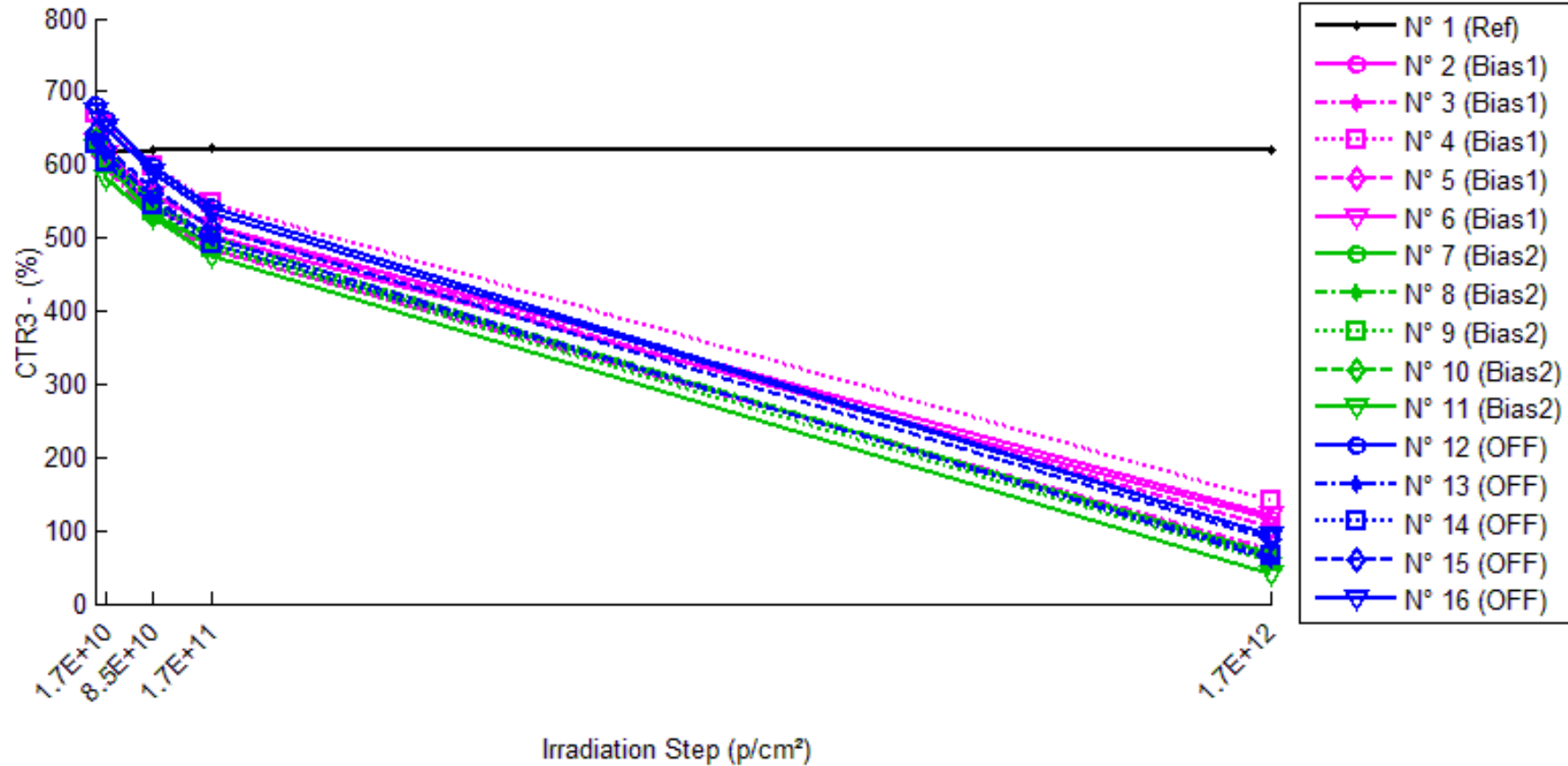

30 MeV proton / detailed results

CTR3 . (%)

	0.p/cm ²	1.7E10.p/cm ²	8.5E10.p/cm ²	1.7E11.p/cm ²	1.7E12.p/cm ²
N° 1 (Ref)	621.42	617.44	619.50	621.78	619.64
N° 2 (Bias1)	626.13	603.20	541.93	501.76	115.58
N° 3 (Bias1)	616.98	594.79	530.01	484.03	72.95
N° 4 (Bias1)	670.25	653.84	597.52	547.34	140.43
N° 5 (Bias1)	632.91	615.63	558.88	513.51	103.81
N° 6 (Bias1)	631.91	615.08	558.73	517.20	121.36
N° 7 (Bias2)	628.81	603.46	529.65	491.55	67.99
N° 8 (Bias2)	637.52	617.68	546.42	499.52	65.87
N° 9 (Bias2)	629.33	605.65	535.23	487.63	55.80
N° 10 (Bias2)	634.88	607.05	549.79	499.52	64.03
N° 11 (Bias2)	621.82	581.85	527.16	476.15	39.58
N° 12 (OFF)	681.89	660.72	597.49	541.14	92.63
N° 13 (OFF)	634.48	613.53	552.93	500.29	61.10
N° 14 (OFF)	627.77	604.77	545.01	493.22	64.35
N° 15 (OFF)	644.04	624.05	566.59	515.09	88.39
N° 16 (OFF)	673.87	651.64	589.22	535.11	93.34

1/Delta [CTR3]

	0.p/cm ²	1.7E10.p/cm ²	8.5E10.p/cm ²	1.7E11.p/cm ²	1.7E12.p/cm ²
N° 1 (Ref)	---	1.038E-5	4.971E-6	-9.423E-7	4.619E-6
N° 2 (Bias1)	---	6.072E-5	2.482E-4	3.959E-4	7.055E-3
N° 3 (Bias1)	---	6.046E-5	2.660E-4	4.452E-4	1.209E-2
N° 4 (Bias1)	---	3.744E-5	1.816E-4	3.350E-4	5.629E-3
N° 5 (Bias1)	---	4.435E-5	2.093E-4	3.674E-4	8.053E-3
N° 6 (Bias1)	---	4.330E-5	2.073E-4	3.510E-4	6.657E-3
N° 7 (Bias2)	---	6.681E-5	2.977E-4	4.441E-4	1.312E-2
N° 8 (Bias2)	---	5.037E-5	2.615E-4	4.333E-4	1.361E-2
N° 9 (Bias2)	---	6.212E-5	2.794E-4	4.617E-4	1.633E-2
N° 10 (Bias2)	---	7.219E-5	2.438E-4	4.268E-4	1.404E-2
N° 11 (Bias2)	---	1.105E-4	2.888E-4	4.920E-4	2.366E-2
N° 12 (OFF)	---	4.697E-5	2.071E-4	3.814E-4	9.329E-3
N° 13 (OFF)	---	5.381E-5	2.325E-4	4.228E-4	1.479E-2
N° 14 (OFF)	---	6.056E-5	2.419E-4	4.346E-4	1.395E-2
N° 15 (OFF)	---	4.974E-5	2.123E-4	3.887E-4	9.761E-3
N° 16 (OFF)	---	5.062E-5	2.132E-4	3.848E-4	9.230E-3
Average (OFF)	---	4.925E-5	2.225E-4	3.789E-4	7.897E-3
σ (OFF)	---	1.068E-5	3.401E-5	4.335E-5	2.499E-3
Average+3σ (OFF)	---	8.129E-5	3.245E-4	5.089E-4	1.539E-2
Average-3σ (OFF)	---	1.722E-5	1.204E-4	2.488E-4	3.997E-4
Average (Bias1)	---	7.239E-5	2.742E-4	4.516E-4	1.615E-2
σ (Bias1)	---	2.276E-5	2.168E-5	2.616E-5	4.372E-3
Average+3σ (Bias1)	---	1.407E-4	3.393E-4	5.301E-4	2.927E-2
Average-3σ (Bias1)	---	4.111E-6	2.092E-4	3.731E-4	3.038E-3
Average (Bias2)	---	5.234E-5	2.214E-4	4.025E-4	1.141E-2
σ (Bias2)	---	5.205E-6	1.497E-5	2.442E-5	2.723E-3
Average+3σ (Bias2)	---	6.796E-5	2.663E-4	4.757E-4	1.958E-2
Average-3σ (Bias2)	---	3.673E-5	1.765E-4	3.292E-4	3.242E-3

30 MeV proton / detailed results

13.CTR4

Ta = 25°C ; IF = 40mA ; Vce = 5V

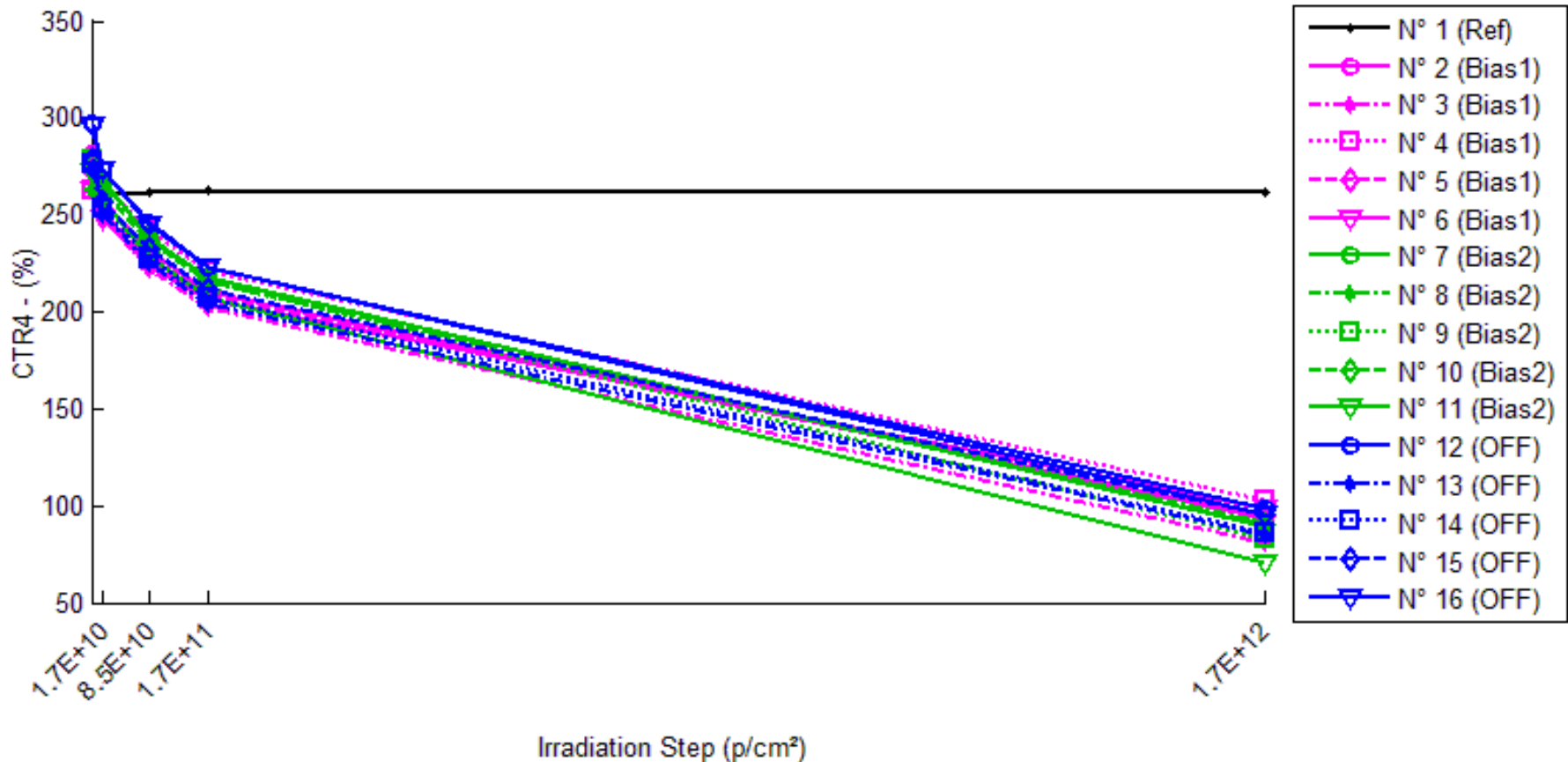

30 MeV proton / detailed results

CTR4 . (%)

	0.p/cm ²	1.7E10.p/cm ²	8.5E10.p/cm ²	1.7E11.p/cm ²	1.7E12.p/cm ²
N° 1 (Ref)	274.52	261.13	261.69	262.42	261.53
N° 2 (Bias1)	281.56	257.39	231.81	210.37	93.80
N° 3 (Bias1)	270.84	249.44	222.07	202.13	80.60
N° 4 (Bias1)	262.49	266.20	241.88	220.95	103.19
N° 5 (Bias1)	272.30	251.30	227.18	208.05	94.45
N° 6 (Bias1)	262.49	248.56	224.13	206.66	98.95
N° 7 (Bias2)	277.97	267.73	237.44	217.25	88.76
N° 8 (Bias2)	262.49	267.67	238.59	215.58	91.74
N° 9 (Bias2)	278.36	267.01	238.79	215.58	83.41
N° 10 (Bias2)	276.00	262.04	236.84	216.17	90.39
N° 11 (Bias2)	272.57	257.74	228.26	207.43	70.35
N° 12 (OFF)	296.75	272.71	245.99	222.92	98.70
N° 13 (OFF)	273.66	250.69	225.20	203.68	84.98
N° 14 (OFF)	276.29	253.23	227.34	207.07	86.25
N° 15 (OFF)	278.47	256.71	232.41	211.29	95.07
N° 16 (OFF)	296.02	272.83	244.97	223.22	95.31

1/Delta [CTR4]

	0.p/cm ²	1.7E10.p/cm ²	8.5E10.p/cm ²	1.7E11.p/cm ²	1.7E12.p/cm ²
N° 1 (Ref)	---	1.868E-4	1.787E-4	1.681E-4	1.810E-4
N° 2 (Bias1)	---	3.336E-4	7.622E-4	1.202E-3	7.110E-3
N° 3 (Bias1)	---	3.168E-4	8.109E-4	1.255E-3	8.715E-3
N° 4 (Bias1)	---	-5.301E-5	3.247E-4	7.163E-4	5.881E-3
N° 5 (Bias1)	---	3.069E-4	7.293E-4	1.134E-3	6.915E-3
N° 6 (Bias1)	---	2.136E-4	6.520E-4	1.029E-3	6.296E-3
N° 7 (Bias2)	---	1.376E-4	6.140E-4	1.006E-3	7.669E-3
N° 8 (Bias2)	---	-7.372E-5	3.816E-4	8.290E-4	7.091E-3
N° 9 (Bias2)	---	1.526E-4	5.953E-4	1.046E-3	8.396E-3
N° 10 (Bias2)	---	1.930E-4	5.990E-4	1.003E-3	7.441E-3
N° 11 (Bias2)	---	2.111E-4	7.122E-4	1.152E-3	1.055E-2
N° 12 (OFF)	---	2.972E-4	6.955E-4	1.116E-3	6.762E-3
N° 13 (OFF)	---	3.348E-4	7.864E-4	1.256E-3	8.113E-3
N° 14 (OFF)	---	3.295E-4	7.793E-4	1.210E-3	7.975E-3
N° 15 (OFF)	---	3.043E-4	7.116E-4	1.142E-3	6.928E-3
N° 16 (OFF)	---	2.871E-4	7.040E-4	1.102E-3	7.113E-3
Average (OFF)	---	2.236E-4	6.558E-4	1.067E-3	6.983E-3
σ (OFF)	---	1.615E-4	1.939E-4	2.136E-4	1.085E-3
Average+3 σ (OFF)	---	7.081E-4	1.238E-3	1.708E-3	1.024E-2
Average-3 σ (OFF)	---	-2.609E-4	7.407E-5	4.264E-4	3.729E-3
Average (Bias1)	---	1.241E-4	5.804E-4	1.007E-3	8.229E-3
σ (Bias1)	---	1.145E-4	1.210E-4	1.165E-4	1.381E-3
Average+3 σ (Bias1)	---	4.677E-4	9.435E-4	1.357E-3	1.237E-2
Average-3 σ (Bias1)	---	-2.194E-4	2.174E-4	6.575E-4	4.086E-3
Average (Bias2)	---	3.106E-4	7.354E-4	1.165E-3	7.378E-3
σ (Bias2)	---	2.070E-5	4.380E-5	6.548E-5	6.221E-4
Average+3 σ (Bias2)	---	3.727E-4	8.668E-4	1.361E-3	9.245E-3
Average-3 σ (Bias2)	---	2.485E-4	6.040E-4	9.686E-4	5.512E-3

30 MeV proton / detailed results

14.CTR5

Ta = 25°C ; IF = 10mA ; Vce = 32V

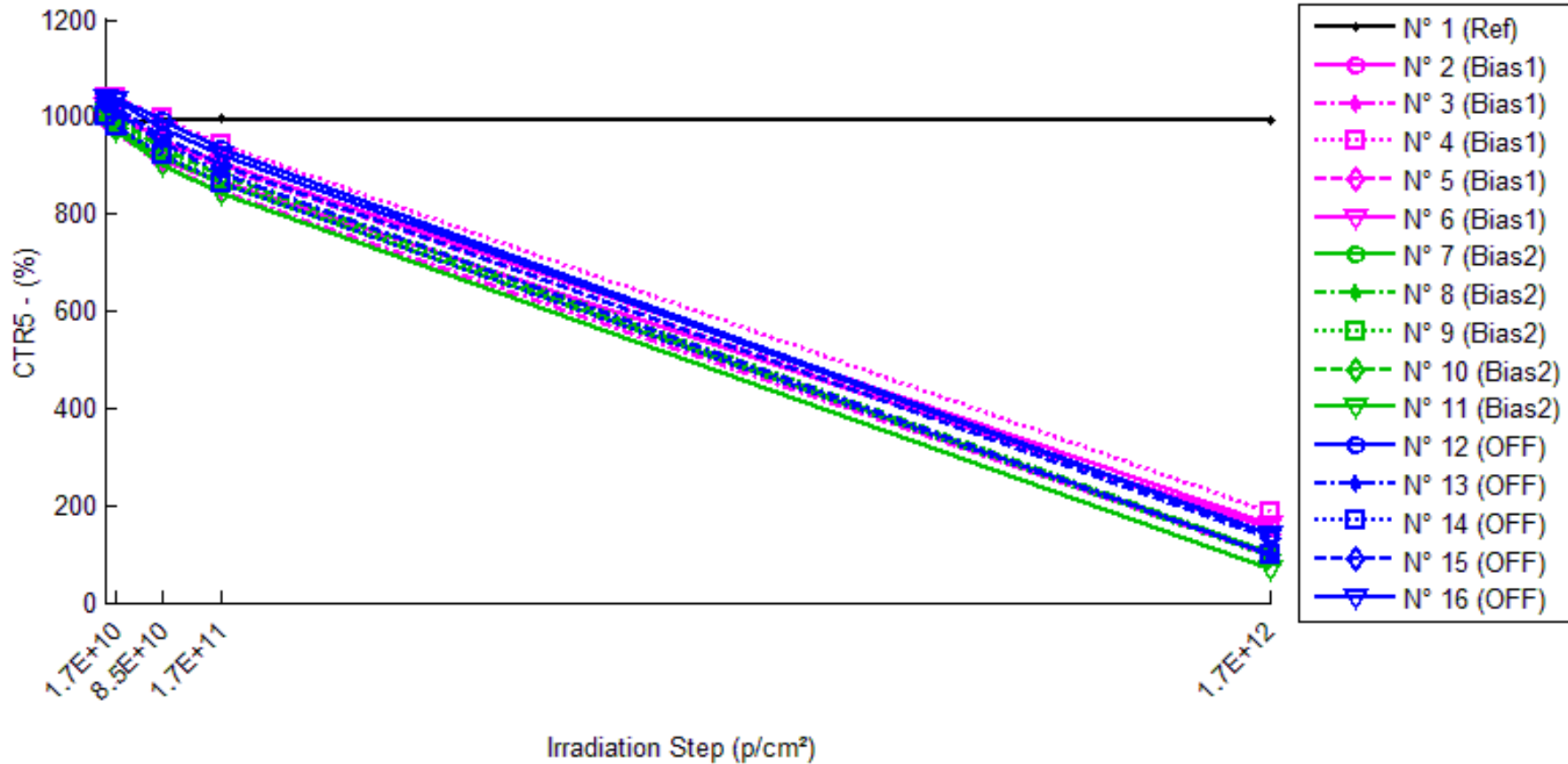

30 MeV proton / detailed results

CTR5 . (%)

	0.p/cm ²	1.7E10.p/cm ²	8.5E10.p/cm ²	1.7E11.p/cm ²	1.7E12.p/cm ²
N° 1 (Ref)	993.778	989.318	993.400	995.789	991.696
N° 2 (Bias1)	996.336	974.976	910.221	867.340	151.793
N° 3 (Bias1)	989.877	969.978	902.146	847.073	100.317
N° 4 (Bias1)	1039.913	1039.022	995.211	941.452	187.431
N° 5 (Bias1)	1020.834	1007.454	948.329	895.157	139.545
N° 6 (Bias1)	1021.774	1008.990	952.364	903.158	162.755
N° 7 (Bias2)	1005.286	978.320	918.913	863.075	101.242
N° 8 (Bias2)	1026.698	1010.168	948.396	886.241	101.181
N° 9 (Bias2)	1008.380	988.388	923.609	869.233	92.550
N° 10 (Bias2)	1016.594	997.719	935.673	879.698	99.834
N° 11 (Bias2)	997.497	972.584	902.899	842.329	67.929
N° 12 (OFF)	1039.919	1039.849	992.824	933.601	139.125
N° 13 (OFF)	1024.497	1008.316	946.881	884.353	100.078
N° 14 (OFF)	1002.341	981.551	920.672	863.703	99.035
N° 15 (OFF)	1030.314	1016.160	959.316	901.936	130.696
N° 16 (OFF)	1039.911	1033.659	978.292	921.075	139.426

1/Delta [CTR5]

	0.p/cm ²	1.7E10.p/cm ²	8.5E10.p/cm ²	1.7E11.p/cm ²	1.7E12.p/cm ²
N° 1 (Ref)	---	4.536E-6	3.821E-7	-2.032E-6	2.112E-6
N° 2 (Bias1)	---	2.199E-5	9.496E-5	1.493E-4	5.584E-3
N° 3 (Bias1)	---	2.072E-5	9.824E-5	1.703E-4	8.958E-3
N° 4 (Bias1)	---	8.246E-7	4.319E-5	1.006E-4	4.374E-3
N° 5 (Bias1)	---	1.301E-5	7.490E-5	1.375E-4	6.187E-3
N° 6 (Bias1)	---	1.240E-5	7.133E-5	1.285E-4	5.166E-3
N° 7 (Bias2)	---	2.742E-5	9.350E-5	1.639E-4	8.883E-3
N° 8 (Bias2)	---	1.594E-5	8.042E-5	1.544E-4	8.909E-3
N° 9 (Bias2)	---	2.006E-5	9.102E-5	1.587E-4	9.813E-3
N° 10 (Bias2)	---	1.861E-5	8.507E-5	1.531E-4	9.033E-3
N° 11 (Bias2)	---	2.568E-5	1.050E-4	1.847E-4	1.372E-2
N° 12 (OFF)	---	6.473E-8	4.561E-5	1.095E-4	6.226E-3
N° 13 (OFF)	---	1.566E-5	8.001E-5	1.547E-4	9.016E-3
N° 14 (OFF)	---	2.113E-5	8.850E-5	1.601E-4	9.100E-3
N° 15 (OFF)	---	1.352E-5	7.183E-5	1.381E-4	6.681E-3
N° 16 (OFF)	---	5.816E-6	6.057E-5	1.241E-4	6.211E-3
Average (OFF)	---	1.379E-5	7.652E-5	1.372E-4	6.054E-3
σ (OFF)	---	8.455E-6	2.209E-5	2.578E-5	1.753E-3
Average+3σ (OFF)	---	3.915E-5	1.428E-4	2.146E-4	1.131E-2
Average-3σ (OFF)	---	-1.158E-5	1.025E-5	5.990E-5	7.961E-4
Average (Bias1)	---	2.154E-5	9.101E-5	1.630E-4	1.007E-2
σ (Bias1)	---	4.844E-6	9.359E-6	1.286E-5	2.074E-3
Average+3σ (Bias1)	---	3.607E-5	1.191E-4	2.015E-4	1.629E-2
Average-3σ (Bias1)	---	7.009E-6	6.293E-5	1.244E-4	3.848E-3
Average (Bias2)	---	1.124E-5	6.930E-5	1.373E-4	7.447E-3
σ (Bias2)	---	8.320E-6	1.679E-5	2.105E-5	1.483E-3
Average+3σ (Bias2)	---	3.620E-5	1.197E-4	2.005E-4	1.190E-2
Average-3σ (Bias2)	---	-1.372E-5	1.895E-5	7.417E-5	2.997E-3

30 MeV proton / detailed results

15.TRR

Ta = 25°C ; IF = 2mA ; RL = 100 Ohms ; Irec = 10% Irm

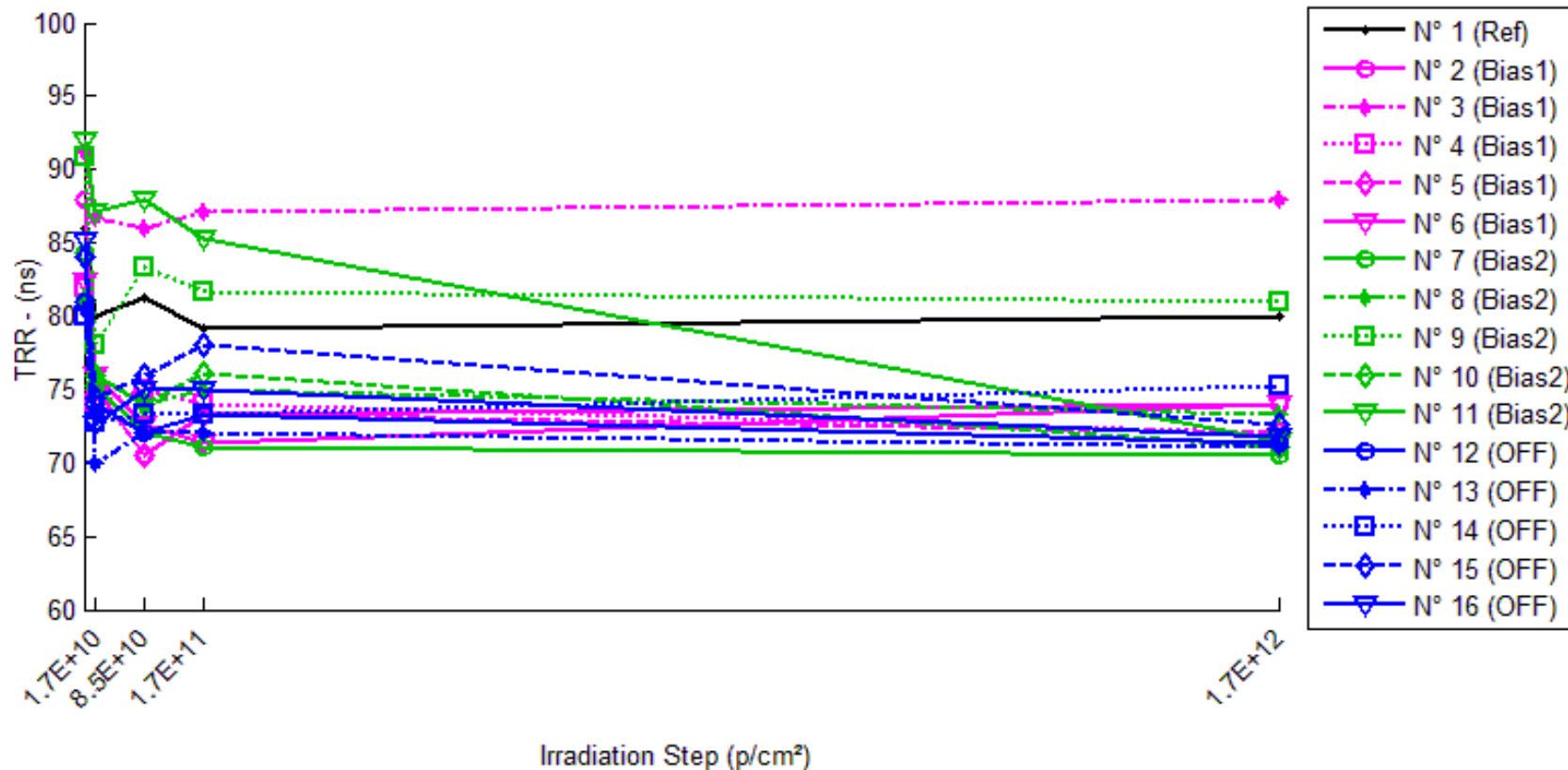

30 MeV proton / detailed results

TRR . (ns)

	0.p/cm ²	1.7E10.p/cm ²	8.5E10.p/cm ²	1.7E11.p/cm ²	1.7E12.p/cm ²
N° 1 (Ref)	86.00	80.00	81.19	79.21	80.00
N° 2 (Bias1)	88.00	75.25	70.59	73.27	74.00
N° 3 (Bias1)	91.09	86.67	85.95	87.13	88.00
N° 4 (Bias1)	82.00	74.00	75.00	74.00	72.00
N° 5 (Bias1)	84.00	75.00	70.59	73.27	72.00
N° 6 (Bias1)	82.35	76.00	72.55	71.29	74.00
N° 7 (Bias2)	84.30	75.25	72.00	71.07	70.59
N° 8 (Bias2)	81.19	76.00	74.00	75.00	73.33
N° 9 (Bias2)	90.91	78.00	83.33	81.67	80.99
N° 10 (Bias2)	80.99	76.00	74.00	76.03	71.07
N° 11 (Bias2)	92.00	87.13	88.00	85.25	71.50
N° 12 (OFF)	80.99	74.00	72.00	73.27	71.29
N° 13 (OFF)	80.39	70.00	72.00	72.00	71.07
N° 14 (OFF)	80.00	72.73	73.27	73.27	75.25
N° 15 (OFF)	84.00	74.38	76.00	78.00	72.55
N° 16 (OFF)	85.15	72.55	75.00	75.00	71.84

Delta [TRR]

	0.p/cm ²	1.7E10.p/cm ²	8.5E10.p/cm ²	1.7E11.p/cm ²	1.7E12.p/cm ²
N° 1 (Ref)	---	-6.000E+0	-4.810E+0	-6.790E+0	-6.000E+0
N° 2 (Bias1)	---	-1.275E+1	-1.741E+1	-1.473E+1	-1.400E+1
N° 3 (Bias1)	---	-4.420E+0	-5.140E+0	-3.960E+0	-3.090E+0
N° 4 (Bias1)	---	-8.000E+0	-7.000E+0	-8.000E+0	-1.000E+1
N° 5 (Bias1)	---	-9.000E+0	-1.341E+1	-1.073E+1	-1.200E+1
N° 6 (Bias1)	---	-6.350E+0	-9.800E+0	-1.106E+1	-8.350E+0
N° 7 (Bias2)	---	-9.050E+0	-1.230E+1	-1.323E+1	-1.371E+1
N° 8 (Bias2)	---	-5.190E+0	-7.190E+0	-6.190E+0	-7.860E+0
N° 9 (Bias2)	---	-1.291E+1	-7.580E+0	-9.240E+0	-9.920E+0
N° 10 (Bias2)	---	-4.990E+0	-6.990E+0	-4.960E+0	-9.920E+0
N° 11 (Bias2)	---	-4.870E+0	-4.000E+0	-6.750E+0	-2.050E+1
N° 12 (OFF)	---	-6.990E+0	-8.990E+0	-7.720E+0	-9.700E+0
N° 13 (OFF)	---	-1.039E+1	-8.390E+0	-8.390E+0	-9.320E+0
N° 14 (OFF)	---	-7.270E+0	-6.730E+0	-6.730E+0	-4.750E+0
N° 15 (OFF)	---	-9.620E+0	-8.000E+0	-6.000E+0	-1.145E+1
N° 16 (OFF)	---	-1.260E+1	-1.015E+1	-1.015E+1	-1.331E+1
Average (OFF)	---	-8.104E+0	-1.055E+1	-9.696E+0	-9.488E+0
σ (OFF)	---	3.124E+0	4.941E+0	4.002E+0	4.158E+0
Average+3 σ (OFF)	---	1.269E+0	4.272E+0	2.309E+0	2.986E+0
Average-3 σ (OFF)	---	-1.748E+1	-2.538E+1	-2.170E+1	-2.196E+1
Average (Bias1)	---	-7.402E+0	-7.612E+0	-8.074E+0	-1.238E+1
σ (Bias1)	---	3.542E+0	2.983E+0	3.277E+0	5.006E+0
Average+3 σ (Bias1)	---	3.223E+0	1.337E+0	1.756E+0	2.636E+0
Average-3 σ (Bias1)	---	-1.803E+1	-1.656E+1	-1.790E+1	-2.740E+1
Average (Bias2)	---	-9.374E+0	-8.452E+0	-7.798E+0	-9.706E+0
σ (Bias2)	---	2.324E+0	1.260E+0	1.602E+0	3.191E+0
Average+3 σ (Bias2)	---	-2.401E+0	-4.673E+0	-2.993E+0	-1.317E-1
Average-3 σ (Bias2)	---	-1.635E+1	-1.223E+1	-1.260E+1	-1.928E+1

60 MeV proton / detailed results

CONTENTS

1. Ic(on)	2
2. CTR1	4
3. Vce(sat)	6
4. BVceo	8
5. BVeco	10
6. Ice(off)	12
7. VF	14
8. Ir	16
9. TR	18
10. TF	20
11. CTR2	22
12. CTR3	24
13. CTR4	26
14. CTR5	28
15. TRR	30

60 MeV proton / detailed results

1. Ic(on)

Ta = 25°C ; IF = 1mA ; Vce = 5V

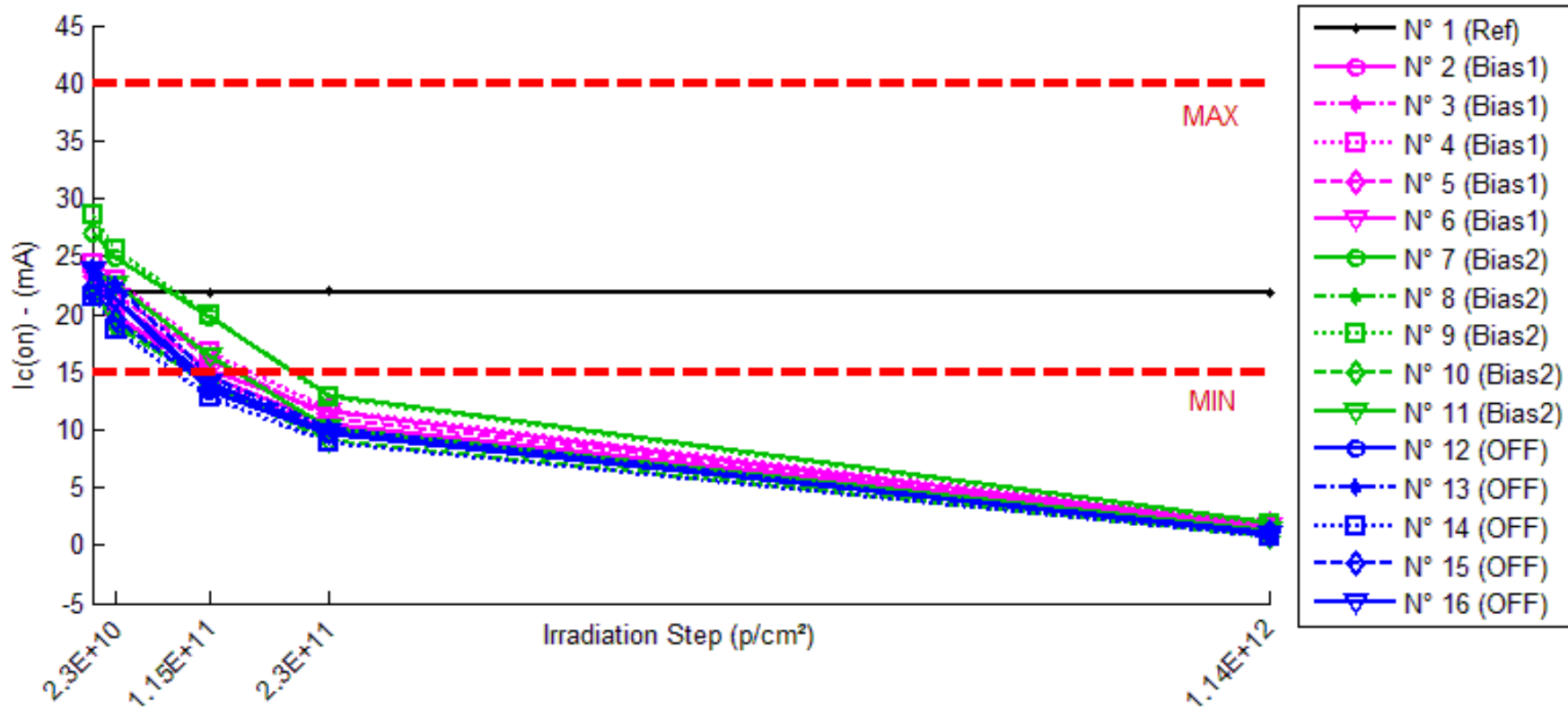

60 MeV proton / detailed results

Ic(on) . (mA)

Min = 2.0

	0.p/cm ²	2.3E10.p/cm ²	1.15E11.p/cm ²	2.3E11.p/cm ²	1.14E12.p/cm ²
N° 1 (Ref)	21.772	21.864	21.924	21.967	21.858
N° 2 (Bias1)	21.973	19.977	14.588	10.542	1.578
N° 3 (Bias1)	21.582	19.938	13.998	9.999	1.378
N° 4 (Bias1)	24.346	22.997	16.762	11.813	1.855
N° 5 (Bias1)	23.242	21.627	16.184	11.126	1.902
N° 6 (Bias1)	23.701	21.190	15.134	11.576	1.583
N° 7 (Bias2)	27.066	24.816	19.664	12.980	1.994
N° 8 (Bias2)	22.033	19.575	13.650	9.590	1.000
N° 9 (Bias2)	28.635	25.519	19.853	12.883	1.771
N° 10 (Bias2)	21.694	18.967	13.845	9.108	0.849
N° 11 (Bias2)	23.852	22.495	16.331	10.118	1.256
N° 12 (OFF)	21.926	21.394	13.377	9.568	1.066
N° 13 (OFF)	23.902	22.651	14.529	10.160	1.026
N° 14 (OFF)	21.578	18.709	12.824	8.853	0.770
N° 15 (OFF)	22.396	19.596	13.731	9.822	1.106
N° 16 (OFF)	23.746	21.321	14.081	9.747	0.883

Delta [Ic(on)]

	0.p/cm ²	2.3E10.p/cm ²	1.15E11.p/cm ²	2.3E11.p/cm ²	1.14E12.p/cm ²
N° 1 (Ref)	---	9.134E-2	1.511E-1	1.943E-1	8.567E-2
N° 2 (Bias1)	---	-1.996E+0	-7.385E+0	-1.143E+1	-2.040E+1
N° 3 (Bias1)	---	-1.644E+0	-7.584E+0	-1.158E+1	-2.020E+1
N° 4 (Bias1)	---	-1.350E+0	-7.584E+0	-1.253E+1	-2.249E+1
N° 5 (Bias1)	---	-1.615E+0	-7.058E+0	-1.212E+1	-2.134E+1
N° 6 (Bias1)	---	-2.511E+0	-8.567E+0	-1.213E+1	-2.212E+1
N° 7 (Bias2)	---	-2.250E+0	-7.401E+0	-1.409E+1	-2.507E+1
N° 8 (Bias2)	---	-2.458E+0	-8.383E+0	-1.244E+1	-2.103E+1
N° 9 (Bias2)	---	-3.117E+0	-8.783E+0	-1.575E+1	-2.686E+1
N° 10 (Bias2)	---	-2.727E+0	-7.850E+0	-1.259E+1	-2.085E+1
N° 11 (Bias2)	---	-1.357E+0	-7.521E+0	-1.373E+1	-2.260E+1
N° 12 (OFF)	---	-5.318E-1	-8.549E+0	-1.236E+1	-2.086E+1
N° 13 (OFF)	---	-1.251E+0	-9.373E+0	-1.374E+1	-2.288E+1
N° 14 (OFF)	---	-2.868E+0	-8.754E+0	-1.272E+1	-2.081E+1
N° 15 (OFF)	---	-2.799E+0	-8.665E+0	-1.257E+1	-2.129E+1
N° 16 (OFF)	---	-2.425E+0	-9.665E+0	-1.400E+1	-2.286E+1
Average (OFF)	---	-1.823E+0	-7.636E+0	-1.196E+1	-2.131E+1
σ (OFF)	---	4.481E-1	5.633E-1	4.482E-1	1.013E+0
Average+3σ (OFF)	---	-4.787E-1	-5.946E+0	-1.061E+1	-1.827E+1
Average-3σ (OFF)	---	-3.167E+0	-9.326E+0	-1.330E+1	-2.435E+1
Average (Bias1)	---	-2.382E+0	-7.988E+0	-1.372E+1	-2.328E+1
σ (Bias1)	---	6.581E-1	5.850E-1	1.340E+0	2.622E+0
Average+3σ (Bias1)	---	-4.075E-1	-6.233E+0	-9.701E+0	-1.542E+1
Average-3σ (Bias1)	---	-4.356E+0	-9.742E+0	-1.774E+1	-3.115E+1
Average (Bias2)	---	-1.975E+0	-9.001E+0	-1.308E+1	-2.174E+1
σ (Bias2)	---	1.035E+0	4.893E-1	7.394E-1	1.048E+0
Average+3σ (Bias2)	---	1.131E+0	-7.533E+0	-1.086E+1	-1.859E+1
Average-3σ (Bias2)	---	-5.081E+0	-1.047E+1	-1.530E+1	-2.488E+1

60 MeV proton / detailed results

2. CTR1

Ta = 25°C ; IF = 1mA ; Vce = 5V

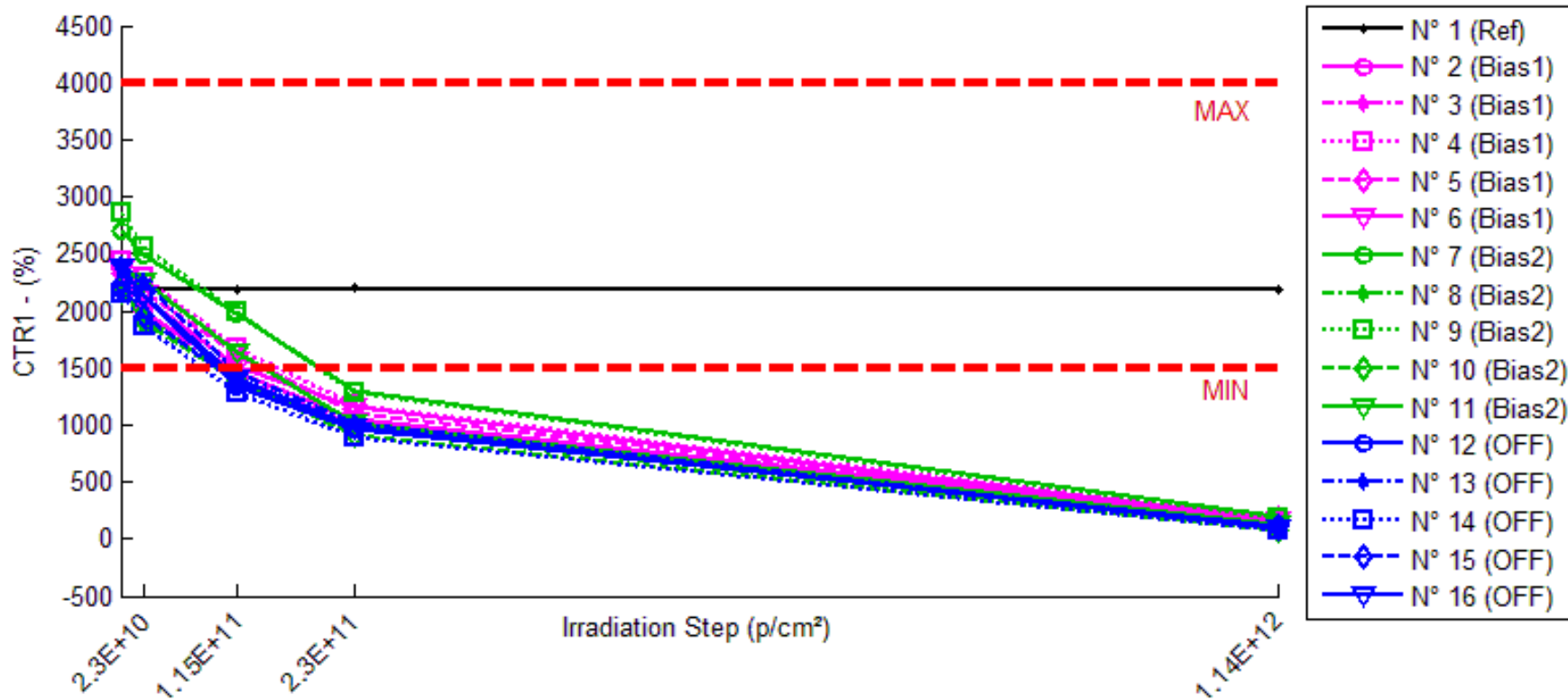

60 MeV proton / detailed results

CTR1 . (%)

	0,p/cm ²	2.3E10,p/cm ²	1.15E11,p/cm ²	2.3E11,p/cm ²	1.14E12,p/cm ²
N° 1 (Ref)	2177.25	2186.38	2192.36	2196.67	2185.82
N° 2 (Bias1)	2197.30	1997.74	1458.78	1054.25	157.78
N° 3 (Bias1)	2158.19	1993.79	1399.83	999.95	137.75
N° 4 (Bias1)	2434.62	2299.67	1676.24	1181.27	185.55
N° 5 (Bias1)	2324.22	2162.74	1618.37	1112.55	190.25
N° 6 (Bias1)	2370.11	2118.97	1513.37	1157.59	158.33
N° 7 (Bias2)	2706.59	2481.63	1966.45	1297.96	199.43
N° 8 (Bias2)	2203.27	1957.47	1365.02	959.00	99.99
N° 9 (Bias2)	2863.54	2551.87	1985.26	1288.33	177.08
N° 10 (Bias2)	2169.45	1896.75	1384.47	910.80	84.86
N° 11 (Bias2)	2385.20	2249.48	1633.10	1011.81	125.57
N° 12 (OFF)	2192.58	2139.41	1337.68	956.80	106.60
N° 13 (OFF)	2390.21	2265.14	1452.86	1016.03	102.60
N° 14 (OFF)	2157.78	1870.94	1282.37	885.31	76.95
N° 15 (OFF)	2239.59	1959.65	1373.09	982.17	110.61
N° 16 (OFF)	2374.58	2132.07	1408.07	974.65	88.29

1/Delta [CTR1]

	0,p/cm ²	2.3E10,p/cm ²	1.15E11,p/cm ²	2.3E11,p/cm ²	1.14E12,p/cm ²
N° 1 (Ref)	---	-1.919E-6	-3.166E-6	-4.062E-6	-1.800E-6
N° 2 (Bias1)	---	4.546E-5	2.304E-4	4.934E-4	5.883E-3
N° 3 (Bias1)	---	3.821E-5	2.510E-4	5.367E-4	6.796E-3
N° 4 (Bias1)	---	2.410E-5	1.858E-4	4.358E-4	4.979E-3
N° 5 (Bias1)	---	3.212E-5	1.877E-4	4.686E-4	4.826E-3
N° 6 (Bias1)	---	5.001E-5	2.389E-4	4.419E-4	5.894E-3
N° 7 (Bias2)	---	3.349E-5	1.391E-4	4.010E-4	4.645E-3
N° 8 (Bias2)	---	5.699E-5	2.787E-4	5.889E-4	9.547E-3
N° 9 (Bias2)	---	4.265E-5	1.545E-4	4.270E-4	5.298E-3
N° 10 (Bias2)	---	6.627E-5	2.614E-4	6.370E-4	1.132E-2
N° 11 (Bias2)	---	2.530E-5	1.931E-4	5.691E-4	7.544E-3
N° 12 (OFF)	---	1.134E-5	2.915E-4	5.891E-4	8.924E-3
N° 13 (OFF)	---	2.310E-5	2.699E-4	5.658E-4	9.329E-3
N° 14 (OFF)	---	7.105E-5	3.164E-4	6.661E-4	1.253E-2
N° 15 (OFF)	---	6.378E-5	2.818E-4	5.716E-4	8.594E-3
N° 16 (OFF)	---	4.790E-5	2.891E-4	6.049E-4	1.091E-2
Average (OFF)	---	3.798E-5	2.188E-4	4.753E-4	5.676E-3
σ (OFF)	---	1.034E-5	3.013E-5	4.128E-5	7.990E-4
Average+3σ (OFF)	---	6.899E-5	3.092E-4	5.991E-4	8.072E-3
Average-3σ (OFF)	---	6.967E-6	1.284E-4	3.514E-4	3.279E-3
Average (Bias1)	---	4.494E-5	2.053E-4	5.246E-4	7.672E-3
σ (Bias1)	---	1.675E-5	6.255E-5	1.043E-4	2.814E-3
Average+3σ (Bias1)	---	9.520E-5	3.930E-4	8.376E-4	1.611E-2
Average-3σ (Bias1)	---	-5.315E-6	1.769E-5	2.115E-4	-7.691E-4
Average (Bias2)	---	4.343E-5	2.897E-4	5.995E-4	1.006E-2
σ (Bias2)	---	2.569E-5	1.709E-5	4.026E-5	1.643E-3
Average+3σ (Bias2)	---	1.205E-4	3.410E-4	7.203E-4	1.499E-2
Average-3σ (Bias2)	---	-3.364E-5	2.384E-4	4.787E-4	5.128E-3

60 MeV proton / detailed results

3. Vce(sat)

Ta = 25°C ; IF = 1mA ; Ic = 2mA

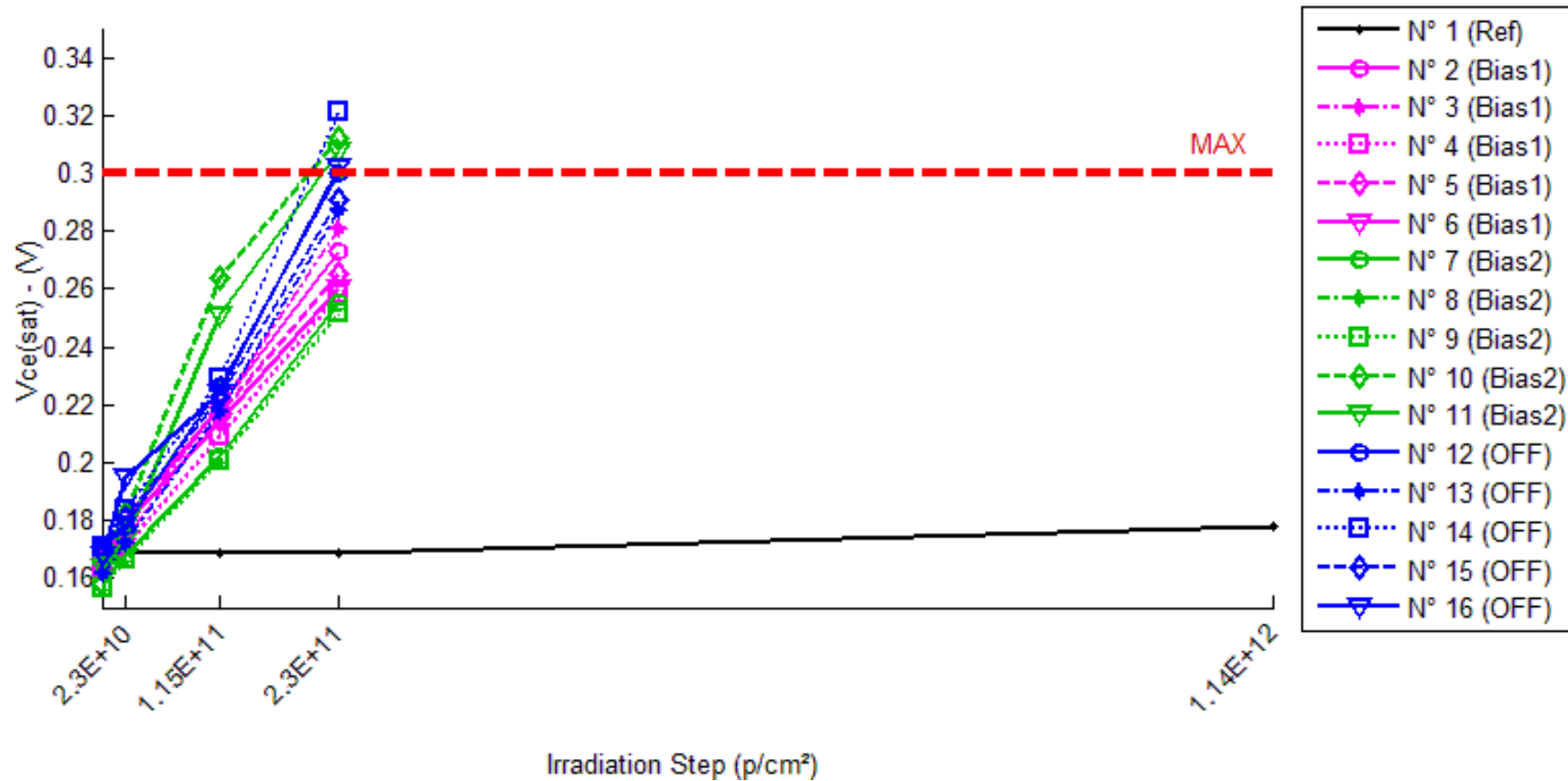

60 MeV proton / detailed results

Vce(sat) . (V)

Max = 0.3

	0.p/cm ²	2.3E10.p/cm ²	1.15E11.p/cm ²	2.3E11.p/cm ²	1.14E12.p/cm ²
N° 1 (Ref)	0.170	0.169	0.169	0.169	0.178
N° 2 (Bias1)	0.170	0.181	0.219	0.273	Not Measurable*
N° 3 (Bias1)	0.167	0.177	0.219	0.281	Not Measurable*
N° 4 (Bias1)	0.164	0.171	0.209	0.258	Not Measurable*
N° 5 (Bias1)	0.165	0.174	0.217	0.265	Not Measurable*
N° 6 (Bias1)	0.168	0.179	0.214	0.260	Not Measurable*
N° 7 (Bias2)	0.158	0.168	0.202	0.255	Not Measurable*
N° 8 (Bias2)	0.166	0.179	0.226	0.300	Not Measurable*
N° 9 (Bias2)	0.157	0.167	0.201	0.252	Not Measurable*
N° 10 (Bias2)	0.168	0.182	0.264	0.312	Not Measurable*
N° 11 (Bias2)	0.164	0.174	0.251	0.308	Not Measurable*
N° 12 (OFF)	0.171	0.178	0.226	0.300	Not Measurable*
N° 13 (OFF)	0.162	0.172	0.218	0.287	Not Measurable*
N° 14 (OFF)	0.171	0.184	0.229	0.321	Not Measurable*
N° 15 (OFF)	0.169	0.181	0.223	0.291	Not Measurable*
N° 16 (OFF)	0.168	0.195	0.224	0.302	Not Measurable*

*(CTR1 > 200%)

Delta [Vce(sat)]

	0.p/cm ²	2.3E10.p/cm ²	1.15E11.p/cm ²	2.3E11.p/cm ²	1.14E12.p/cm ²
N° 1 (Ref)	---	-8.370E-4	-8.472E-4	-3.343E-4	8.377E-3
N° 2 (Bias1)	---	1.063E-2	4.862E-2	1.023E-1	NaN
N° 3 (Bias1)	---	9.673E-3	5.175E-2	1.139E-1	NaN
N° 4 (Bias1)	---	7.622E-3	4.548E-2	9.397E-2	NaN
N° 5 (Bias1)	---	8.699E-3	5.174E-2	1.003E-1	NaN
N° 6 (Bias1)	---	1.018E-2	4.562E-2	9.191E-2	NaN
N° 7 (Bias2)	---	1.018E-2	4.478E-2	9.733E-2	NaN
N° 8 (Bias2)	---	1.282E-2	5.983E-2	1.343E-1	NaN
N° 9 (Bias2)	---	9.542E-3	4.422E-2	9.484E-2	NaN
N° 10 (Bias2)	---	1.410E-2	9.623E-2	1.438E-1	NaN
N° 11 (Bias2)	---	1.022E-2	8.727E-2	1.444E-1	NaN
N° 12 (OFF)	---	6.629E-3	5.444E-2	1.284E-1	NaN
N° 13 (OFF)	---	9.544E-3	5.632E-2	1.251E-1	NaN
N° 14 (OFF)	---	1.325E-2	5.865E-2	1.505E-1	NaN
N° 15 (OFF)	---	1.243E-2	5.397E-2	1.217E-1	NaN
N° 16 (OFF)	---	2.698E-2	5.644E-2	1.342E-1	NaN
Average (OFF)	---	9.363E-3	4.864E-2	1.005E-1	NaN
σ (OFF)	---	1.210E-3	3.100E-3	8.634E-3	0.000E+0
Average+3σ (OFF)	---	1.299E-2	5.794E-2	1.264E-1	NaN
Average-3σ (OFF)	---	5.732E-3	3.935E-2	7.457E-2	NaN
Average (Bias1)	---	1.137E-2	6.646E-2	1.229E-1	NaN
σ (Bias1)	---	1.979E-3	2.413E-2	2.484E-2	0.000E+0
Average+3σ (Bias1)	---	1.731E-2	1.388E-1	1.974E-1	NaN
Average-3σ (Bias1)	---	5.438E-3	-5.913E-3	4.841E-2	NaN
Average (Bias2)	---	1.377E-2	5.597E-2	1.320E-1	NaN
σ (Bias2)	---	7.834E-3	1.859E-3	1.133E-2	0.000E+0
Average+3σ (Bias2)	---	3.727E-2	6.154E-2	1.660E-1	NaN
Average-3σ (Bias2)	---	-9.736E-3	5.039E-2	9.798E-2	NaN

60 MeV proton / detailed results

4. BV_{ceo}

T_a = 25°C ; I_{ce} = 1mA

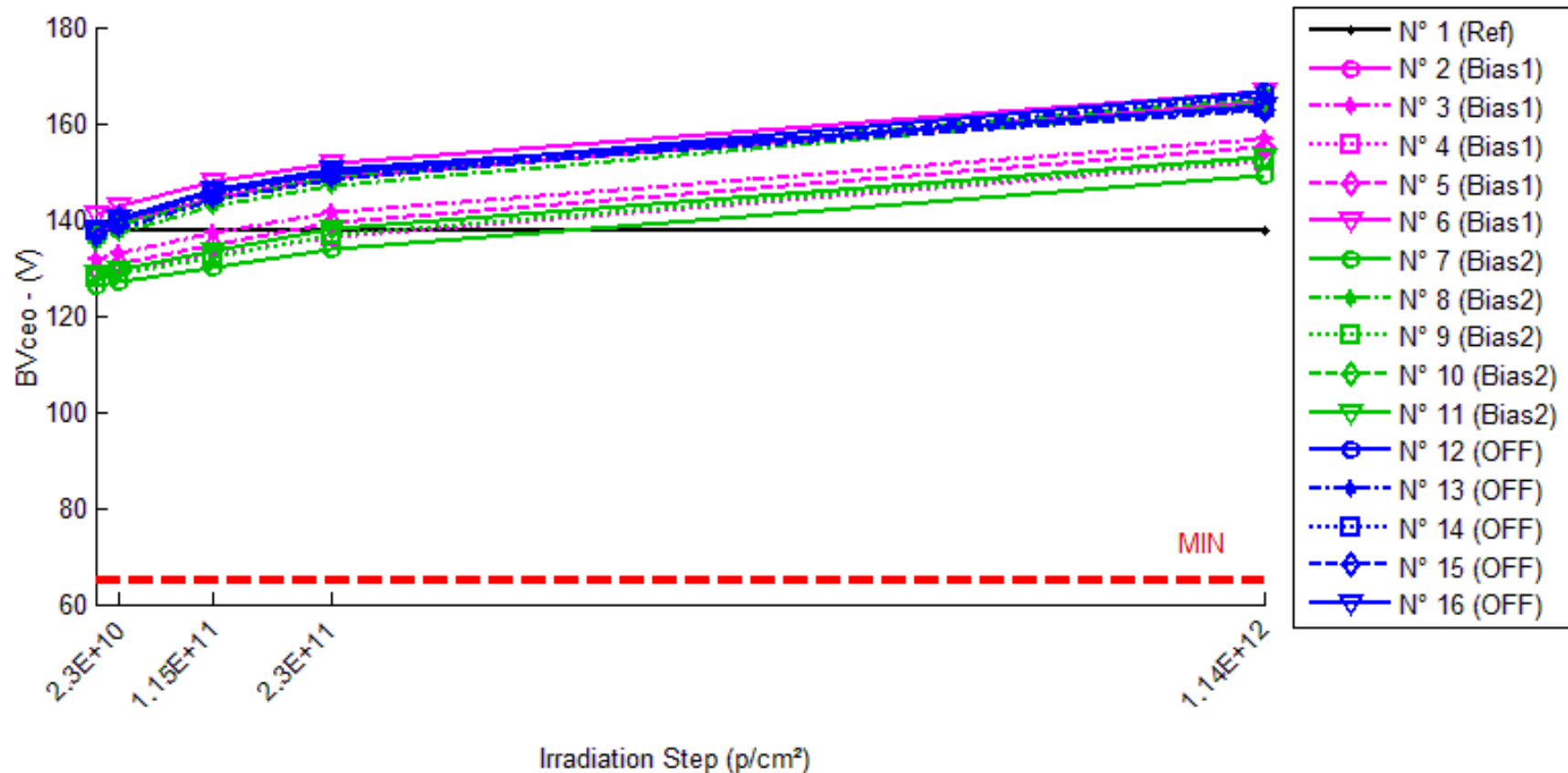

60 MeV proton / detailed results

BVceo . (V)

Min = 65.0

	0.p/cm ²	2.3E10.p/cm ²	1.15E11.p/cm ²	2.3E11.p/cm ²	1.14E12.p/cm ²
N° 1 (Ref)	137.64	137.60	137.63	137.59	137.62
N° 2 (Bias1)	137.27	139.28	144.64	148.64	164.52
N° 3 (Bias1)	131.77	132.97	137.41	141.62	156.97
N° 4 (Bias1)	127.91	128.88	132.63	136.41	151.96
N° 5 (Bias1)	129.68	130.72	134.78	139.20	155.10
N° 6 (Bias1)	141.05	142.83	148.07	151.77	166.74
N° 7 (Bias2)	126.03	126.89	129.79	133.98	149.28
N° 8 (Bias2)	135.16	137.21	142.93	147.19	164.23
N° 9 (Bias2)	127.84	128.69	132.27	136.80	152.67
N° 10 (Bias2)	136.50	138.89	143.92	148.70	165.50
N° 11 (Bias2)	128.52	129.61	133.45	138.06	153.05
N° 12 (OFF)	137.72	139.92	145.60	149.56	166.58
N° 13 (OFF)	135.99	138.17	144.20	148.46	165.79
N° 14 (OFF)	137.68	139.94	145.51	149.73	163.20
N° 15 (OFF)	137.86	140.02	145.64	149.60	162.92
N° 16 (OFF)	137.83	140.11	146.23	150.35	163.80

Delta [BVceo]

	0.p/cm ²	2.3E10.p/cm ²	1.15E11.p/cm ²	2.3E11.p/cm ²	1.14E12.p/cm ²
N° 1 (Ref)	---	-3.400E-2	-9.800E-3	-4.170E-2	-1.600E-2
N° 2 (Bias1)	---	2.015E+0	7.377E+0	1.137E+1	2.726E+1
N° 3 (Bias1)	---	1.200E+0	5.634E+0	9.847E+0	2.520E+1
N° 4 (Bias1)	---	9.702E-1	4.724E+0	8.507E+0	2.405E+1
N° 5 (Bias1)	---	1.035E+0	5.097E+0	9.517E+0	2.541E+1
N° 6 (Bias1)	---	1.786E+0	7.027E+0	1.073E+1	2.570E+1
N° 7 (Bias2)	---	8.679E-1	3.766E+0	7.951E+0	2.325E+1
N° 8 (Bias2)	---	2.045E+0	7.762E+0	1.202E+1	2.906E+1
N° 9 (Bias2)	---	8.513E-1	4.436E+0	8.962E+0	2.483E+1
N° 10 (Bias2)	---	2.388E+0	7.415E+0	1.219E+1	2.900E+1
N° 11 (Bias2)	---	1.086E+0	4.933E+0	9.541E+0	2.453E+1
N° 12 (OFF)	---	2.195E+0	7.884E+0	1.184E+1	2.886E+1
N° 13 (OFF)	---	2.183E+0	8.206E+0	1.247E+1	2.980E+1
N° 14 (OFF)	---	2.251E+0	7.828E+0	1.204E+1	2.551E+1
N° 15 (OFF)	---	2.157E+0	7.778E+0	1.174E+1	2.505E+1
N° 16 (OFF)	---	2.275E+0	8.403E+0	1.252E+1	2.597E+1
Average (OFF)	---	1.401E+0	5.972E+0	9.993E+0	2.552E+1
σ (OFF)	---	4.704E-1	1.175E+0	1.105E+0	1.153E+0
Average+3σ (OFF)	---	2.812E+0	9.497E+0	1.331E+1	2.898E+1
Average-3σ (OFF)	---	-1.021E-2	2.447E+0	6.677E+0	2.207E+1
Average (Bias1)	---	1.448E+0	5.662E+0	1.013E+1	2.614E+1
σ (Bias1)	---	7.183E-1	1.810E+0	1.891E+0	2.710E+0
Average+3σ (Bias1)	---	3.603E+0	1.109E+1	1.581E+1	3.427E+1
Average-3σ (Bias1)	---	-7.072E-1	2.315E-1	4.461E+0	1.800E+1
Average (Bias2)	---	2.212E+0	8.020E+0	1.212E+1	2.704E+1
σ (Bias2)	---	4.940E-2	2.714E-1	3.591E-1	2.142E+0
Average+3σ (Bias2)	---	2.360E+0	8.834E+0	1.320E+1	3.347E+1
Average-3σ (Bias2)	---	2.064E+0	7.205E+0	1.104E+1	2.061E+1

60 MeV proton / detailed results

5. BV_{eco}

T_a = 25°C ; I_{ec} = 100μA

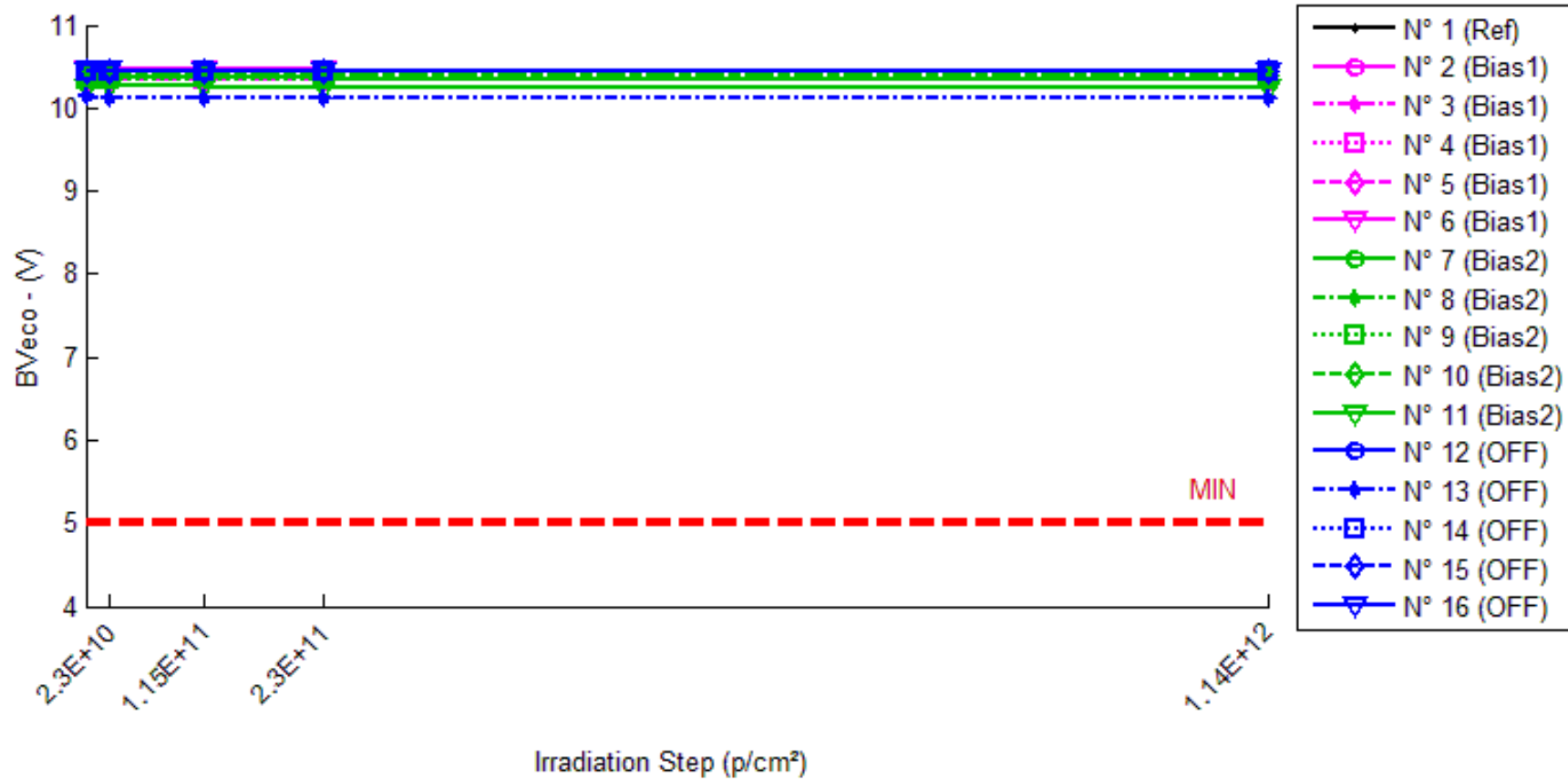

60 MeV proton / detailed results

BVeco . (V)

Min = 5.0

	0.p/cm ²	2.3E10.p/cm ²	1.15E11.p/cm ²	2.3E11.p/cm ²	1.14E12.p/cm ²
N° 1 (Ref)	10.440	10.438	10.439	10.438	10.439
N° 2 (Bias1)	10.448	10.447	10.454	10.448	10.439
N° 3 (Bias1)	10.339	10.338	10.341	10.342	10.344
N° 4 (Bias1)	10.343	10.342	10.348	10.349	10.348
N° 5 (Bias1)	10.340	10.339	10.348	10.342	10.335
N° 6 (Bias1)	10.460	10.456	10.458	10.459	10.445
N° 7 (Bias2)	10.362	10.362	10.369	10.361	10.352
N° 8 (Bias2)	10.393	10.390	10.394	10.388	10.381
N° 9 (Bias2)	10.350	10.349	10.359	10.350	10.345
N° 10 (Bias2)	10.416	10.418	10.424	10.412	10.401
N° 11 (Bias2)	10.253	10.259	10.258	10.247	10.232
N° 12 (OFF)	10.439	10.430	10.431	10.431	10.441
N° 13 (OFF)	10.135	10.130	10.127	10.124	10.126
N° 14 (OFF)	10.438	10.436	10.437	10.435	10.433
N° 15 (OFF)	10.447	10.445	10.446	10.442	10.437
N° 16 (OFF)	10.449	10.455	10.446	10.442	10.444

Delta [BVeco]

	0.p/cm ²	2.3E10.p/cm ²	1.15E11.p/cm ²	2.3E11.p/cm ²	1.14E12.p/cm ²
N° 1 (Ref)	---	-1.340E-3	-1.170E-3	-2.000E-3	-3.000E-4
N° 2 (Bias1)	---	-3.700E-4	6.070E-3	-1.300E-4	-9.060E-3
N° 3 (Bias1)	---	-6.000E-4	1.720E-3	2.840E-3	4.870E-3
N° 4 (Bias1)	---	-2.000E-4	5.250E-3	6.340E-3	5.520E-3
N° 5 (Bias1)	---	-9.500E-4	8.610E-3	2.610E-3	-4.260E-3
N° 6 (Bias1)	---	-3.190E-3	-1.150E-3	-9.200E-4	-1.465E-2
N° 7 (Bias2)	---	5.500E-4	7.340E-3	-1.300E-4	-9.530E-3
N° 8 (Bias2)	---	-2.900E-3	1.030E-3	-4.940E-3	-1.224E-2
N° 9 (Bias2)	---	-9.600E-4	8.240E-3	-6.300E-4	-5.060E-3
N° 10 (Bias2)	---	1.590E-3	7.940E-3	-4.290E-3	-1.461E-2
N° 11 (Bias2)	---	6.060E-3	4.450E-3	-5.840E-3	-2.158E-2
N° 12 (OFF)	---	-9.240E-3	-7.980E-3	-8.070E-3	1.750E-3
N° 13 (OFF)	---	-5.120E-3	-8.440E-3	-1.134E-2	-9.140E-3
N° 14 (OFF)	---	-1.940E-3	-1.370E-3	-2.680E-3	-4.970E-3
N° 15 (OFF)	---	-2.690E-3	-1.680E-3	-5.590E-3	-1.037E-2
N° 16 (OFF)	---	6.110E-3	-2.960E-3	-6.470E-3	-4.750E-3
Average (OFF)	---	-1.062E-3	4.100E-3	2.148E-3	-3.516E-3
σ (OFF)	---	1.222E-3	3.833E-3	2.866E-3	8.764E-3
Average+3 σ (OFF)	---	2.605E-3	1.560E-2	1.075E-2	2.278E-2
Average-3 σ (OFF)	---	-4.729E-3	-7.399E-3	-6.451E-3	-2.981E-2
Average (Bias1)	---	8.680E-4	5.800E-3	-3.166E-3	-1.260E-2
σ (Bias1)	---	3.359E-3	3.061E-3	2.608E-3	6.146E-3
Average+3 σ (Bias1)	---	1.094E-2	1.498E-2	4.658E-3	5.834E-3
Average-3 σ (Bias1)	---	-9.208E-3	-3.383E-3	-1.099E-2	-3.104E-2
Average (Bias2)	---	-2.576E-3	-4.486E-3	-6.830E-3	-5.496E-3
σ (Bias2)	---	5.629E-3	3.455E-3	3.192E-3	4.753E-3
Average+3 σ (Bias2)	---	1.431E-2	5.880E-3	2.747E-2	8.764E-3
Average-3 σ (Bias2)	---	-1.946E-2	-1.485E-2	-1.641E-2	-1.976E-2

60 MeV proton / detailed results

6. Ice(off)

Ta = 25°C ; Vce = 20V

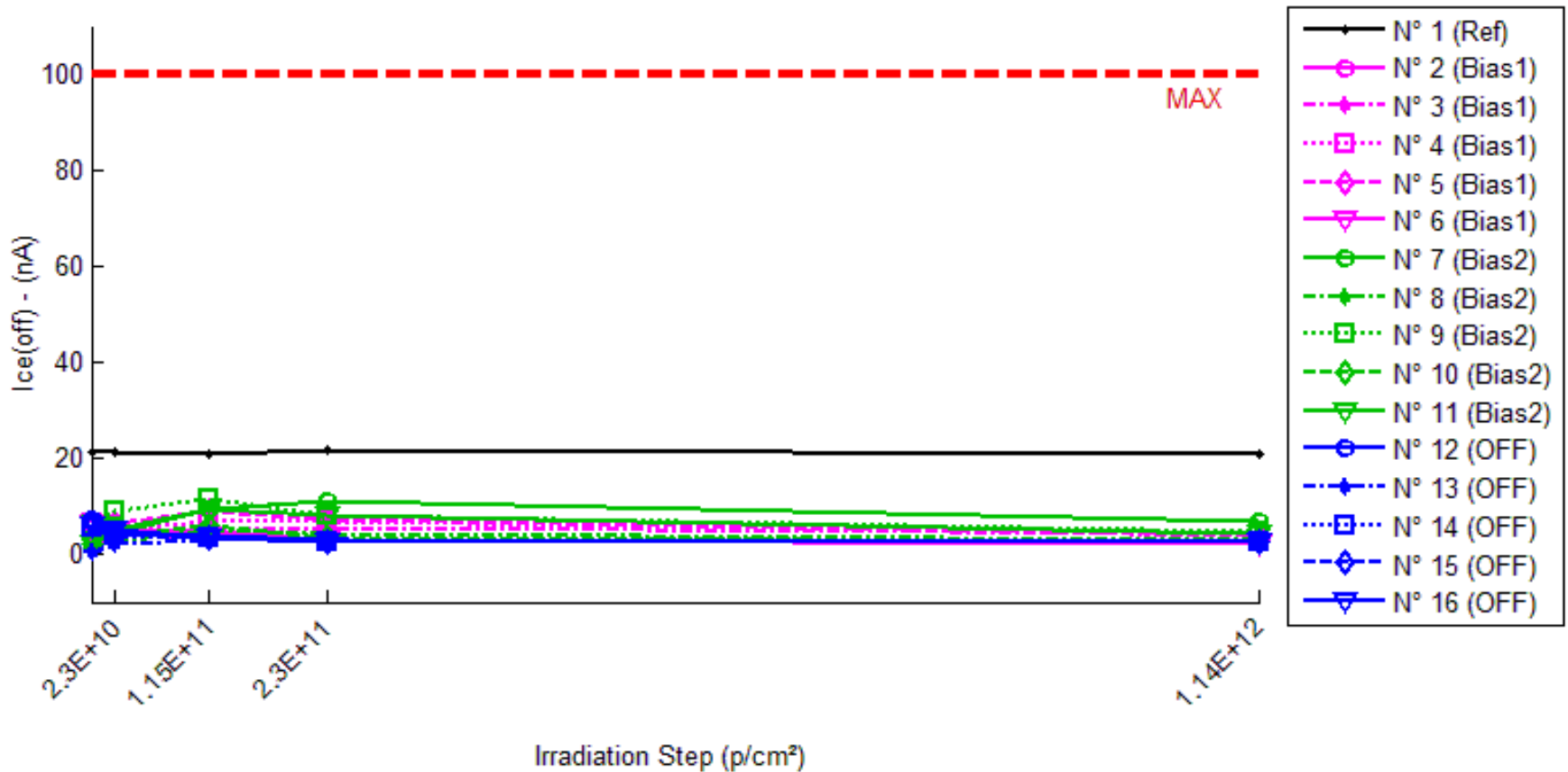

60 MeV proton / detailed results

Ice(off) . (nA)

Max = 100.0

	0,p/cm ²	2.3E10.p/cm ²	1.15E11.p/cm ²	2.3E11.p/cm ²	1.14E12.p/cm ²
N° 1 (Ref)	21.395	21.468	21.056	21.521	20.751
N° 2 (Bias1)	6.557	4.965	4.771	3.056	2.415
N° 3 (Bias1)	2.058	3.432	5.256	5.355	4.152
N° 4 (Bias1)	6.569	5.018	6.861	6.891	3.967
N° 5 (Bias1)	5.642	6.541	8.892	7.086	3.753
N° 6 (Bias1)	6.369	4.373	3.540	3.160	2.211
N° 7 (Bias2)	2.037	4.100	9.564	10.860	6.678
N° 8 (Bias2)	0.718	2.679	4.968	4.053	2.781
N° 9 (Bias2)	5.999	9.036	11.696	7.973	4.839
N° 10 (Bias2)	3.158	3.999	5.836	3.356	2.546
N° 11 (Bias2)	2.155	5.275	9.329	8.256	4.363
N° 12 (OFF)	7.140	4.465	3.709	3.017	2.553
N° 13 (OFF)	0.513	2.050	3.117	2.996	2.602
N° 14 (OFF)	5.356	3.891	3.343	2.681	2.455
N° 15 (OFF)	6.319	4.249	3.533	2.721	2.447
N° 16 (OFF)	6.030	5.161	3.293	2.610	2.498

Delta [Ice(off)]

	0,p/cm ²	2.3E10.p/cm ²	1.15E11.p/cm ²	2.3E11.p/cm ²	1.14E12.p/cm ²
N° 1 (Ref)	---	7.308E-2	-3.390E-1	1.254E-1	-6.440E-1
N° 2 (Bias1)	---	-1.592E+0	-1.786E+0	-3.501E+0	-4.142E+0
N° 3 (Bias1)	---	1.374E+0	3.199E+0	3.298E+0	2.095E+0
N° 4 (Bias1)	---	-1.551E+0	2.917E-1	3.223E-1	-2.603E+0
N° 5 (Bias1)	---	8.984E-1	3.249E+0	1.444E+0	-1.890E+0
N° 6 (Bias1)	---	-1.996E+0	-2.828E+0	-3.208E+0	-4.157E+0
N° 7 (Bias2)	---	2.064E+0	7.528E+0	8.823E+0	4.641E+0
N° 8 (Bias2)	---	1.961E+0	4.251E+0	3.335E+0	2.063E+0
N° 9 (Bias2)	---	3.036E+0	5.697E+0	1.973E+0	-1.160E+0
N° 10 (Bias2)	---	8.409E-1	2.678E+0	1.979E-1	-6.128E-1
N° 11 (Bias2)	---	3.121E+0	7.174E+0	6.101E+0	2.208E+0
N° 12 (OFF)	---	-2.676E+0	-3.431E+0	-4.123E+0	-4.587E+0
N° 13 (OFF)	---	1.537E+0	2.604E+0	2.483E+0	2.089E+0
N° 14 (OFF)	---	-1.465E+0	-2.013E+0	-2.674E+0	-2.901E+0
N° 15 (OFF)	---	-2.070E+0	-2.787E+0	-3.598E+0	-3.872E+0
N° 16 (OFF)	---	-8.681E-1	-2.736E+0	-3.420E+0	-3.531E+0
Average (OFF)	---	-5.732E-1	4.253E-1	-3.290E-1	-2.139E+0
σ (OFF)	---	1.579E+0	2.791E+0	2.961E+0	2.564E+0
Average+3σ (OFF)	---	4.165E+0	8.798E+0	8.554E+0	5.551E+0
Average-3σ (OFF)	---	-5.311E+0	-7.948E+0	-9.212E+0	-9.830E+0
Average (Bias1)	---	2.205E+0	5.465E+0	4.086E+0	1.428E+0
σ (Bias1)	---	9.314E-1	2.029E+0	3.415E+0	2.356E+0
Average+3σ (Bias1)	---	4.999E+0	1.155E+1	1.433E+1	8.496E+0
Average-3σ (Bias1)	---	-5.896E-1	-6.226E-1	-6.159E+0	-5.640E+0
Average (Bias2)	---	-1.108E+0	-1.673E+0	-2.266E+0	-2.560E+0
σ (Bias2)	---	1.625E+0	2.443E+0	2.705E+0	2.669E+0
Average+3σ (Bias2)	---	3.767E+0	5.655E+0	5.850E+0	5.447E+0
Average-3σ (Bias2)	---	-5.984E+0	-9.000E+0	-1.038E+1	-1.057E+1

60 MeV proton / detailed results

7. VF

Ta = 25°C ; VF = 10mA

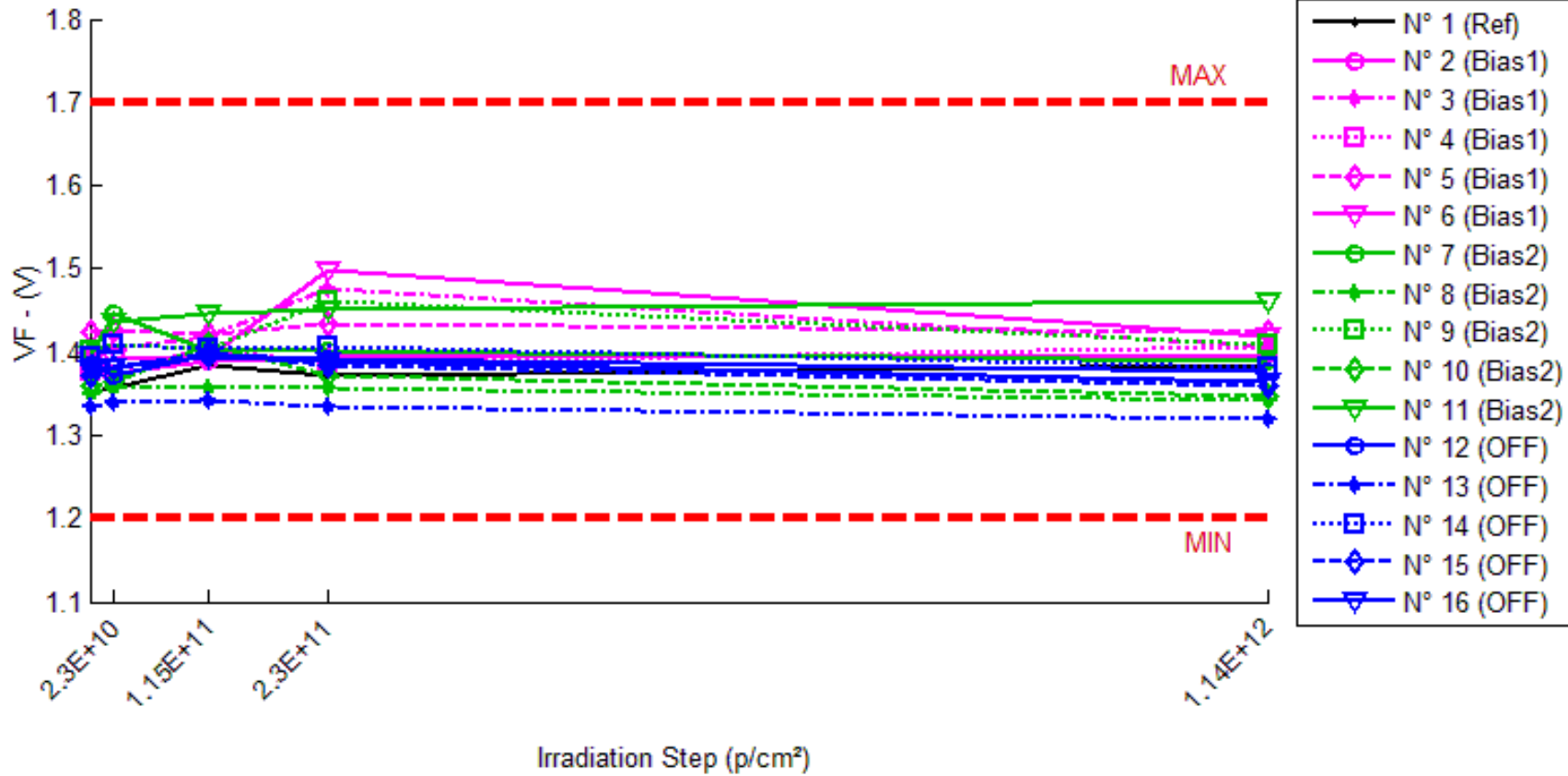

60 MeV proton / detailed results

VF . (V)

Min = 1.2 Max = 1.7

	0.p/cm ²	2.3E10.p/cm ²	1.15E11.p/cm ²	2.3E11.p/cm ²	1.14E12.p/cm ²
N° 1 (Ref)	1.353	1.356	1.385	1.373	1.384
N° 2 (Bias1)	1.374	1.375	1.389	1.394	1.397
N° 3 (Bias1)	1.401	1.404	1.420	1.476	1.407
N° 4 (Bias1)	1.378	1.380	1.405	1.386	1.406
N° 5 (Bias1)	1.423	1.427	1.422	1.435	1.425
N° 6 (Bias1)	1.389	1.392	1.393	1.498	1.420
N° 7 (Bias2)	1.399	1.447	1.402	1.401	1.388
N° 8 (Bias2)	1.350	1.358	1.357	1.357	1.343
N° 9 (Bias2)	1.401	1.409	1.404	1.462	1.408
N° 10 (Bias2)	1.360	1.364	1.410	1.371	1.348
N° 11 (Bias2)	1.397	1.437	1.447	1.451	1.461
N° 12 (OFF)	1.384	1.372	1.396	1.391	1.377
N° 13 (OFF)	1.335	1.339	1.342	1.335	1.319
N° 14 (OFF)	1.395	1.410	1.404	1.406	1.381
N° 15 (OFF)	1.371	1.382	1.399	1.383	1.359
N° 16 (OFF)	1.379	1.382	1.395	1.388	1.365

Delta [VF]

	0.p/cm ²	2.3E10.p/cm ²	1.15E11.p/cm ²	2.3E11.p/cm ²	1.14E12.p/cm ²
N° 1 (Ref)	---	2.533E-3	3.184E-2	1.999E-2	3.075E-2
N° 2 (Bias1)	---	1.343E-3	1.502E-2	1.954E-2	2.330E-2
N° 3 (Bias1)	---	2.909E-3	1.894E-2	7.458E-2	5.975E-3
N° 4 (Bias1)	---	2.143E-3	2.679E-2	8.063E-3	2.742E-2
N° 5 (Bias1)	---	3.887E-3	-1.147E-3	1.177E-2	1.181E-3
N° 6 (Bias1)	---	3.652E-3	4.305E-3	1.097E-1	3.107E-2
N° 7 (Bias2)	---	4.792E-2	3.085E-3	1.664E-3	-1.079E-2
N° 8 (Bias2)	---	8.172E-3	6.708E-3	6.599E-3	-6.593E-3
N° 9 (Bias2)	---	7.913E-3	3.009E-3	6.109E-2	6.635E-3
N° 10 (Bias2)	---	3.197E-3	4.942E-2	1.099E-2	-1.211E-2
N° 11 (Bias2)	---	3.976E-2	4.957E-2	5.391E-2	6.347E-2
N° 12 (OFF)	---	-1.177E-2	1.155E-2	6.586E-3	-7.372E-3
N° 13 (OFF)	---	4.378E-3	6.969E-3	1.170E-4	-1.582E-2
N° 14 (OFF)	---	1.436E-2	9.140E-3	1.056E-2	-1.442E-2
N° 15 (OFF)	---	1.141E-2	2.870E-2	1.239E-2	-1.189E-2
N° 16 (OFF)	---	3.427E-3	1.601E-2	9.386E-3	-1.328E-2
Average (OFF)	---	2.787E-3	1.278E-2	4.472E-2	1.779E-2
σ (OFF)	---	1.057E-3	1.124E-2	4.520E-2	1.337E-2
Average+3σ (OFF)	---	5.959E-3	4.649E-2	1.803E-1	5.790E-2
Average-3σ (OFF)	---	-3.856E-4	-2.093E-2	-9.088E-2	-2.232E-2
Average (Bias1)	---	2.139E-2	2.236E-2	2.685E-2	8.122E-3
σ (Bias1)	---	2.079E-2	2.482E-2	2.829E-2	3.182E-2
Average+3σ (Bias1)	---	8.376E-2	9.681E-2	1.117E-1	1.036E-1
Average-3σ (Bias1)	---	-4.097E-2	-5.210E-2	-5.801E-2	-8.733E-2
Average (Bias2)	---	4.361E-3	1.447E-2	7.809E-3	-1.256E-2
σ (Bias2)	---	1.013E-2	8.633E-3	4.789E-3	3.240E-3
Average+3σ (Bias2)	---	3.476E-2	4.037E-2	2.217E-2	-2.836E-3
Average-3σ (Bias2)	---	-2.604E-2	-1.143E-2	-6.557E-3	-2.228E-2

60 MeV proton / detailed results

8. Ir

Ta = 25°C ; Vr = 2V



60 MeV proton / detailed results

Ir . (µA)

Max = 100.0

	0,p/cm ²	2.3E10,p/cm ²	1.15E11,p/cm ²	2.3E11,p/cm ²	1.14E12,p/cm ²
N° 1 (Ref)	4.186E-5	4.605E-5	4.760E-5	4.160E-5	4.776E-5
N° 2 (Bias1)	3.817E-5	3.884E-5	5.988E-5	3.909E-5	3.892E-5
N° 3 (Bias1)	4.156E-5	3.859E-5	4.114E-5	3.963E-5	4.177E-5
N° 4 (Bias1)	3.754E-5	3.943E-5	3.993E-5	4.366E-5	3.695E-5
N° 5 (Bias1)	3.905E-5	4.051E-5	3.930E-5	4.332E-5	3.817E-5
N° 6 (Bias1)	3.993E-5	3.540E-5	3.972E-5	4.156E-5	2.957E-5
N° 7 (Bias2)	3.737E-5	4.307E-5	4.169E-5	4.278E-5	4.328E-5
N° 8 (Bias2)	3.691E-5	4.374E-5	4.014E-5	4.102E-5	4.341E-5
N° 9 (Bias2)	4.307E-5	4.600E-5	4.986E-5	4.010E-5	3.758E-5
N° 10 (Bias2)	3.913E-5	4.450E-5	4.806E-5	3.913E-5	3.532E-5
N° 11 (Bias2)	4.081E-5	5.778E-5	4.005E-5	4.328E-5	3.829E-5
N° 12 (OFF)	3.553E-5	4.030E-5	4.005E-5	4.106E-5	3.607E-5
N° 13 (OFF)	3.750E-5	4.538E-5	3.880E-5	4.169E-5	3.188E-5
N° 14 (OFF)	3.616E-5	4.026E-5	1.375E-4	3.657E-5	3.494E-5
N° 15 (OFF)	3.595E-5	4.177E-5	4.010E-5	4.026E-5	3.347E-5
N° 16 (OFF)	3.314E-5	1.220E-4	4.110E-5	4.207E-5	3.636E-5

Delta [Ir]

	0,p/cm ²	2.3E10,p/cm ²	1.15E11,p/cm ²	2.3E11,p/cm ²	1.14E12,p/cm ²
N° 1 (Ref)	---	4.190E-6	5.741E-6	-2.536E-7	5.907E-6
N° 2 (Bias1)	---	6.690E-7	2.171E-5	9.201E-7	7.519E-7
N° 3 (Bias1)	---	-2.978E-6	-4.209E-7	-1.930E-6	2.068E-7
N° 4 (Bias1)	---	1.884E-6	2.387E-6	6.117E-6	-5.894E-7
N° 5 (Bias1)	---	1.465E-6	2.498E-7	4.273E-6	-8.827E-7
N° 6 (Bias1)	---	-4.529E-6	-2.115E-7	1.632E-6	-1.036E-5
N° 7 (Bias2)	---	5.698E-6	4.315E-6	5.405E-6	5.907E-6
N° 8 (Bias2)	---	6.829E-6	3.225E-6	4.105E-6	6.494E-6
N° 9 (Bias2)	---	2.931E-6	6.787E-6	-2.978E-6	-5.494E-6
N° 10 (Bias2)	---	5.362E-6	8.925E-6	-2.340E-9	-3.817E-6
N° 11 (Bias2)	---	1.697E-5	-7.570E-7	2.471E-6	-2.518E-6
N° 12 (OFF)	---	4.776E-6	4.525E-6	5.530E-6	5.423E-7
N° 13 (OFF)	---	7.878E-6	1.297E-6	4.189E-6	-5.619E-6
N° 14 (OFF)	---	4.105E-6	1.013E-4	4.169E-7	-1.218E-6
N° 15 (OFF)	---	5.824E-6	4.147E-6	4.315E-6	-2.476E-6
N° 16 (OFF)	---	8.885E-5	7.962E-6	8.925E-6	3.225E-6
Average (OFF)	---	-6.975E-7	4.743E-6	2.203E-6	-2.174E-6
σ (OFF)	---	2.876E-6	9.550E-6	3.109E-6	4.619E-6
Average+3σ (OFF)	---	7.931E-6	3.339E-5	1.153E-5	1.168E-5
Average-3σ (OFF)	---	-9.326E-6	-2.391E-5	-7.124E-6	-1.603E-5
Average (Bias1)	---	7.559E-6	4.499E-6	1.800E-6	1.146E-7
σ (Bias1)	---	5.451E-6	3.678E-6	3.348E-6	5.659E-6
Average+3σ (Bias1)	---	2.391E-5	1.553E-5	1.184E-5	1.709E-5
Average-3σ (Bias1)	---	-8.794E-6	-6.535E-6	-8.244E-6	-1.686E-5
Average (Bias2)	---	2.229E-5	2.385E-5	4.675E-6	-1.109E-6
σ (Bias2)	---	3.724E-5	4.336E-5	3.053E-6	3.306E-6
Average+3σ (Bias2)	---	1.340E-4	1.539E-4	1.384E-5	8.810E-6
Average-3σ (Bias2)	---	-8.943E-5	-1.062E-4	-4.485E-6	-1.103E-5

60 MeV proton / detailed results

9. TR

Ta = 25°C ; Vcc = 10V ; RL = 100 Ohms ; IF = 5mA

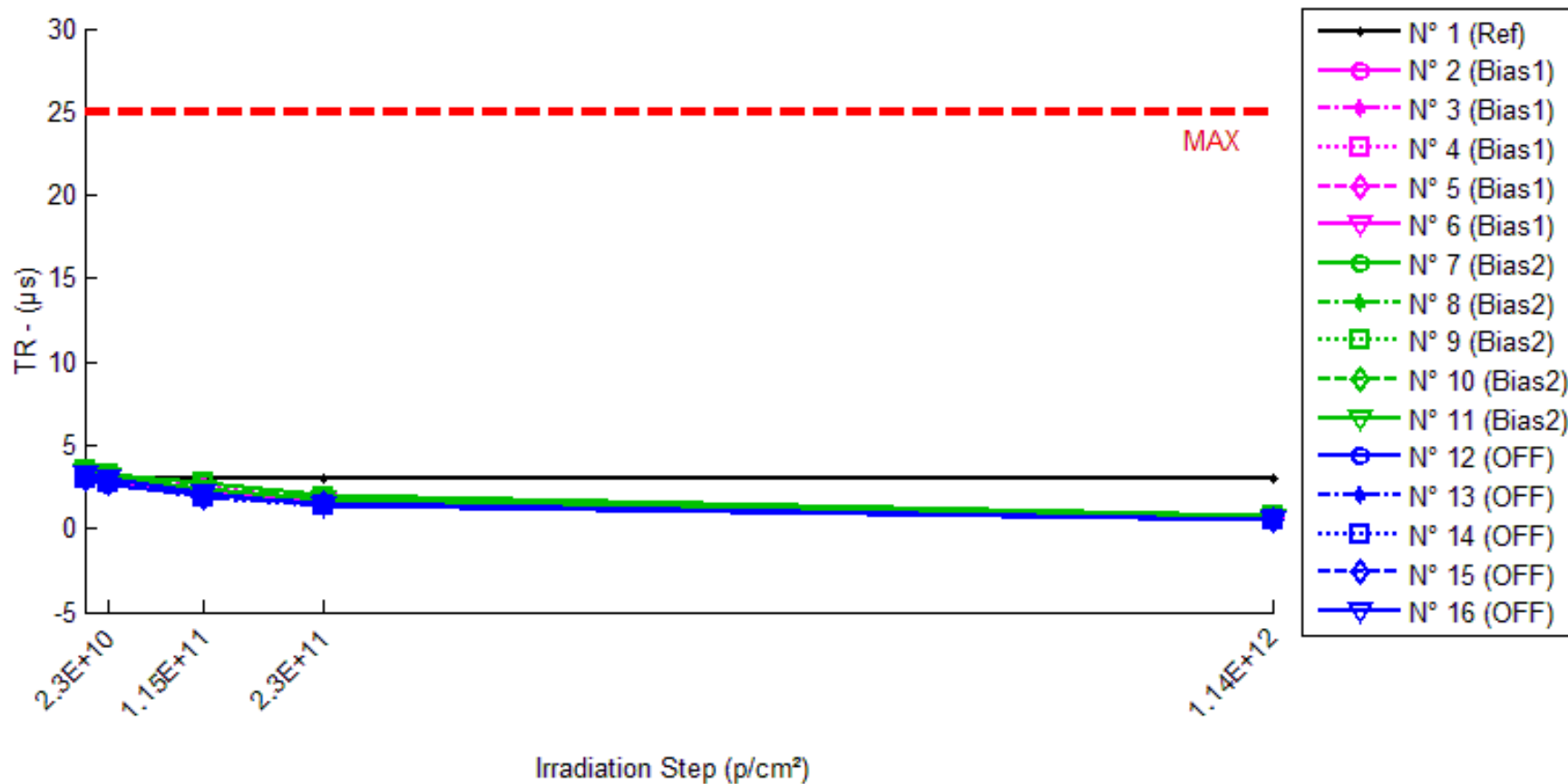

60 MeV proton / detailed results

TR . (μs)

Max = 20.0

	0.p/cm ²	2.3E10.p/cm ²	1.15E11.p/cm ²	2.3E11.p/cm ²	1.14E12.p/cm ²
N° 1 (Ref)	3.1	3.1	3.0	3.0	3.0
N° 2 (Bias1)	3.1	2.8	2.1	1.6	0.6
N° 3 (Bias1)	3.0	2.9	2.2	1.7	0.6
N° 4 (Bias1)	3.5	3.3	2.6	1.9	0.8
N° 5 (Bias1)	3.2	3.1	2.4	1.8	0.6
N° 6 (Bias1)	3.2	3.0	2.3	1.7	0.6
N° 7 (Bias2)	3.4	3.3	2.7	2.0	0.8
N° 8 (Bias2)	2.9	2.7	2.0	1.5	0.5
N° 9 (Bias2)	3.5	3.3	2.7	1.9	0.8
N° 10 (Bias2)	3.0	2.8	2.0	1.5	0.5
N° 11 (Bias2)	3.4	3.1	2.4	1.8	0.7
N° 12 (OFF)	3.0	2.6	2.0	1.5	0.5
N° 13 (OFF)	3.0	2.7	1.9	1.5	0.5
N° 14 (OFF)	3.0	2.7	1.9	1.4	0.5
N° 15 (OFF)	3.0	2.7	1.9	1.5	0.5
N° 16 (OFF)	3.2	3.0	2.1	1.4	0.5

Delta [TR]

	0.p/cm ²	2.3E10.p/cm ²	1.15E11.p/cm ²	2.3E11.p/cm ²	1.14E12.p/cm ²
N° 1 (Ref)	---	0.000E+0	-1.000E-1	-1.000E-1	-1.000E-1
N° 2 (Bias1)	---	-3.000E-1	-1.000E+0	-1.500E+0	-2.500E+0
N° 3 (Bias1)	---	-1.000E-1	-8.000E-1	-1.300E+0	-2.400E+0
N° 4 (Bias1)	---	-2.000E-1	-9.000E-1	-1.600E+0	-2.700E+0
N° 5 (Bias1)	---	-1.000E-1	-8.000E-1	-1.400E+0	-2.600E+0
N° 6 (Bias1)	---	-2.000E-1	-9.000E-1	-1.500E+0	-2.600E+0
N° 7 (Bias2)	---	-1.000E-1	-7.000E-1	-1.400E+0	-2.600E+0
N° 8 (Bias2)	---	-2.000E-1	-9.000E-1	-1.400E+0	-2.400E+0
N° 9 (Bias2)	---	-2.000E-1	-8.000E-1	-1.600E+0	-2.700E+0
N° 10 (Bias2)	---	-2.000E-1	-1.000E+0	-1.500E+0	-2.500E+0
N° 11 (Bias2)	---	-3.000E-1	-1.000E+0	-1.600E+0	-2.700E+0
N° 12 (OFF)	---	-4.000E-1	-1.000E+0	-1.500E+0	-2.500E+0
N° 13 (OFF)	---	-3.000E-1	-1.100E+0	-1.500E+0	-2.500E+0
N° 14 (OFF)	---	-3.000E-1	-1.100E+0	-1.600E+0	-2.500E+0
N° 15 (OFF)	---	-3.000E-1	-1.100E+0	-1.500E+0	-2.500E+0
N° 16 (OFF)	---	-2.000E-1	-1.100E+0	-1.800E+0	-2.700E+0
Average (OFF)	---	-1.800E-1	-8.800E-1	-1.460E+0	-2.560E+0
σ (OFF)	---	8.367E-2	8.367E-2	1.140E-1	1.140E-1
Average+3 σ (OFF)	---	7.100E-2	-6.290E-1	-1.118E+0	-2.218E+0
Average-3 σ (OFF)	---	-4.310E-1	-1.131E+0	-1.802E+0	-2.902E+0
Average (Bias1)	---	-2.000E-1	-8.800E-1	-1.500E+0	-2.580E+0
σ (Bias1)	---	7.071E-2	1.304E-1	1.000E-1	1.304E-1
Average+3 σ (Bias1)	---	1.213E-2	-4.888E-1	-1.200E+0	-2.189E+0
Average-3 σ (Bias1)	---	-4.121E-1	-1.271E+0	-1.800E+0	-2.971E+0
Average (Bias2)	---	-3.000E-1	-1.080E+0	-1.580E+0	-2.540E+0
σ (Bias2)	---	7.071E-2	4.472E-2	1.304E-1	8.944E-2
Average+3 σ (Bias2)	---	-8.787E-2	-9.458E-1	-1.189E+0	-2.272E+0
Average-3 σ (Bias2)	---	-5.121E-1	-1.214E+0	-1.971E+0	-2.808E+0

60 MeV proton / detailed results

10.TF

Ta = 25°C ; Vcc = 10V ; RL = 100 Ohms ; IF = 5mA

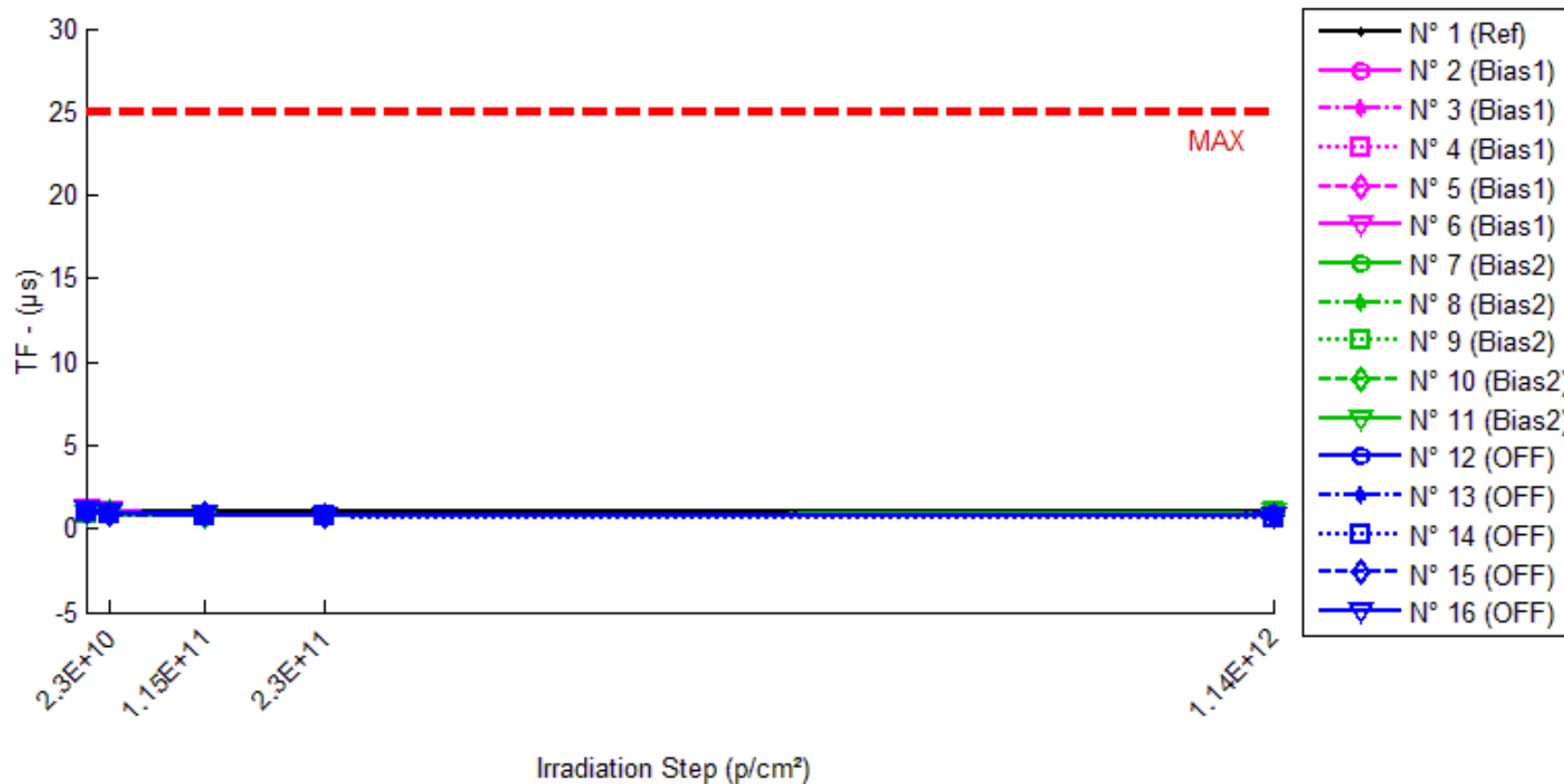

60 MeV proton / detailed results

TF . (μs)

Max = 20.0

	0.p/cm ²	2.3E10.p/cm ²	1.15E11.p/cm ²	2.3E11.p/cm ²	1.14E12.p/cm ²
N° 1 (Ref)	1.0	1.0	1.0	1.0	1.0
N° 2 (Bias1)	1.0	0.9	0.9	0.8	0.9
N° 3 (Bias1)	0.9	0.9	0.8	0.8	0.8
N° 4 (Bias1)	0.9	0.9	0.8	0.8	1.0
N° 5 (Bias1)	1.0	0.9	0.9	0.8	0.8
N° 6 (Bias1)	1.3	1.2	0.8	0.8	0.8
N° 7 (Bias2)	0.9	1.0	0.8	0.8	1.0
N° 8 (Bias2)	1.0	1.0	0.8	0.8	0.8
N° 9 (Bias2)	0.9	0.9	0.8	0.8	1.0
N° 10 (Bias2)	1.0	1.0	0.8	0.8	0.9
N° 11 (Bias2)	0.9	0.9	0.8	0.8	1.0
N° 12 (OFF)	1.0	1.0	0.8	0.8	0.9
N° 13 (OFF)	1.0	0.9	0.8	0.8	0.9
N° 14 (OFF)	1.0	0.9	0.8	0.8	0.7
N° 15 (OFF)	1.0	0.9	0.9	0.8	0.8
N° 16 (OFF)	1.1	1.0	0.9	0.8	0.8

Delta [TF]

	0.p/cm ²	2.3E10.p/cm ²	1.15E11.p/cm ²	2.3E11.p/cm ²	1.14E12.p/cm ²
N° 1 (Ref)	---	0.000E+0	0.000E+0	0.000E+0	0.000E+0
N° 2 (Bias1)	---	-1.000E-1	-1.000E-1	-2.000E-1	-1.000E-1
N° 3 (Bias1)	---	0.000E+0	-1.000E-1	-1.000E-1	-1.000E-1
N° 4 (Bias1)	---	0.000E+0	-1.000E-1	-1.000E-1	1.000E-1
N° 5 (Bias1)	---	-1.000E-1	-1.000E-1	-2.000E-1	-2.000E-1
N° 6 (Bias1)	---	-1.000E-1	-5.000E-1	-5.000E-1	-5.000E-1
N° 7 (Bias2)	---	1.000E-1	-1.000E-1	-1.000E-1	1.000E-1
N° 8 (Bias2)	---	0.000E+0	-2.000E-1	-2.000E-1	-2.000E-1
N° 9 (Bias2)	---	0.000E+0	-1.000E-1	-1.000E-1	1.000E-1
N° 10 (Bias2)	---	0.000E+0	-2.000E-1	-2.000E-1	-1.000E-1
N° 11 (Bias2)	---	0.000E+0	-1.000E-1	-1.000E-1	1.000E-1
N° 12 (OFF)	---	0.000E+0	-2.000E-1	-2.000E-1	-1.000E-1
N° 13 (OFF)	---	-1.000E-1	-2.000E-1	-2.000E-1	-1.000E-1
N° 14 (OFF)	---	-1.000E-1	-2.000E-1	-2.000E-1	-3.000E-1
N° 15 (OFF)	---	-1.000E-1	-1.000E-1	-2.000E-1	-2.000E-1
N° 16 (OFF)	---	-1.000E-1	-2.000E-1	-3.000E-1	-3.000E-1
Average (OFF)	---	-6.000E-2	-1.800E-1	-2.200E-1	-1.600E-1
σ (OFF)	---	5.477E-2	1.789E-1	1.643E-1	2.191E-1
Average+3σ (OFF)	---	1.043E-1	3.567E-1	2.730E-1	4.973E-1
Average-3σ (OFF)	---	-2.243E-1	-7.167E-1	-7.130E-1	-8.173E-1
Average (Bias1)	---	2.000E-2	-1.400E-1	-1.400E-1	0.000E+0
σ (Bias1)	---	4.472E-2	5.477E-2	5.477E-2	1.414E-1
Average+3σ (Bias1)	---	1.542E-1	2.432E-2	2.432E-2	4.243E-1
Average-3σ (Bias1)	---	-1.142E-1	-3.043E-1	-3.043E-1	-4.243E-1
Average (Bias2)	---	-8.000E-2	-1.800E-1	-2.200E-1	-2.000E-1
σ (Bias2)	---	4.472E-2	4.472E-2	4.472E-2	1.000E-1
Average+3σ (Bias2)	---	5.416E-2	-4.584E-2	-8.584E-2	1.000E-1
Average-3σ (Bias2)	---	-2.142E-1	-3.142E-1	-3.542E-1	-5.000E-1

60 MeV proton / detailed results

11.CTR2

Ta = 25°C ; IF = 2mA ; Vce = 5V

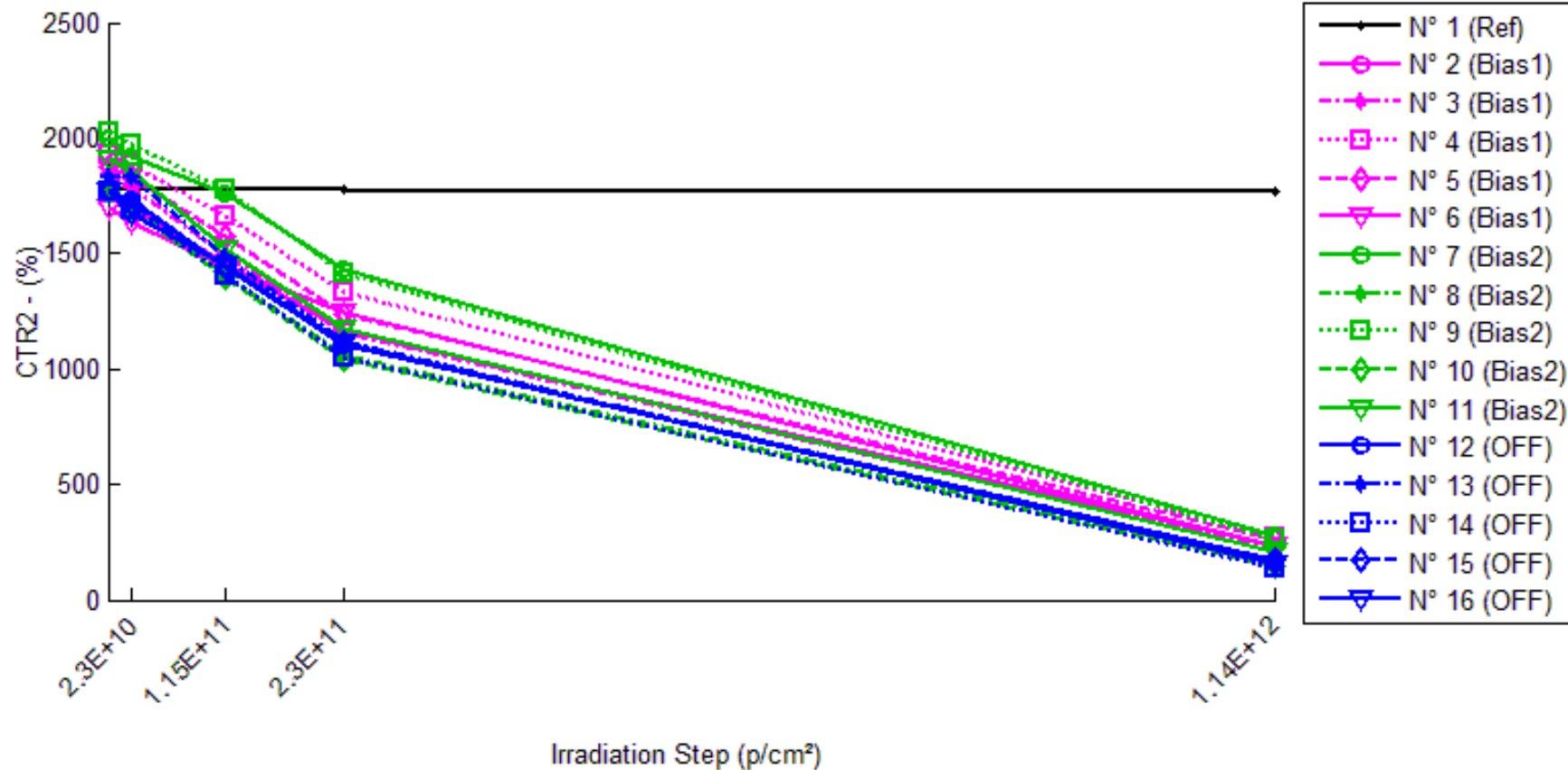

60 MeV proton / detailed results

CTR2 . (%)

	0,p/cm ²	2.3E10.p/cm ²	1.15E11.p/cm ²	2.3E11.p/cm ²	1.14E12.p/cm ²
N° 1 (Ref)	1775.14	1780.28	1778.12	1781.64	1764.81
N° 2 (Bias1)	1757.15	1693.61	1460.20	1168.97	232.33
N° 3 (Bias1)	1838.62	1786.19	1495.22	1160.09	215.86
N° 4 (Bias1)	1928.91	1887.33	1660.61	1330.30	270.36
N° 5 (Bias1)	1875.50	1829.62	1574.49	1235.84	260.88
N° 6 (Bias1)	1699.27	1639.95	1438.66	1246.86	237.53
N° 7 (Bias2)	1995.08	1923.11	1758.62	1431.89	276.89
N° 8 (Bias2)	1775.77	1708.37	1409.55	1059.57	159.55
N° 9 (Bias2)	2023.30	1972.72	1776.04	1417.61	260.62
N° 10 (Bias2)	1770.80	1690.15	1399.47	1039.95	143.92
N° 11 (Bias2)	1913.50	1856.84	1523.18	1177.90	205.25
N° 12 (OFF)	1772.95	1736.90	1439.93	1102.47	175.71
N° 13 (OFF)	1829.41	1831.31	1484.05	1123.68	163.40
N° 14 (OFF)	1767.63	1693.15	1405.08	1051.29	141.35
N° 15 (OFF)	1781.01	1711.64	1443.64	1108.53	173.69
N° 16 (OFF)	1771.89	1667.08	1448.01	1109.79	152.74

1/Delta [CTR2]

	0,p/cm ²	2.3E10.p/cm ²	1.15E11.p/cm ²	2.3E11.p/cm ²	1.14E12.p/cm ²
N° 1 (Ref)	---	-1.625E-6	-9.432E-7	-2.054E-6	3.298E-6
N° 2 (Bias1)	---	2.135E-5	1.157E-4	2.863E-4	3.735E-3
N° 3 (Bias1)	---	1.596E-5	1.249E-4	3.181E-4	4.089E-3
N° 4 (Bias1)	---	1.142E-5	8.376E-5	2.333E-4	3.180E-3
N° 5 (Bias1)	---	1.337E-5	1.019E-4	2.760E-4	3.300E-3
N° 6 (Bias1)	---	2.129E-5	1.066E-4	2.135E-4	3.622E-3
N° 7 (Bias2)	---	1.876E-5	6.739E-5	1.971E-4	3.110E-3
N° 8 (Bias2)	---	2.222E-5	1.463E-4	3.806E-4	5.705E-3
N° 9 (Bias2)	---	1.267E-5	6.881E-5	2.112E-4	3.343E-3
N° 10 (Bias2)	---	2.695E-5	1.498E-4	3.969E-4	6.383E-3
N° 11 (Bias2)	---	1.595E-5	1.339E-4	3.264E-4	4.349E-3
N° 12 (OFF)	---	1.171E-5	1.304E-4	3.430E-4	5.127E-3
N° 13 (OFF)	---	-5.692E-7	1.272E-4	3.433E-4	5.573E-3
N° 14 (OFF)	---	2.489E-5	1.460E-4	3.855E-4	6.509E-3
N° 15 (OFF)	---	2.276E-5	1.312E-4	3.406E-4	5.196E-3
N° 16 (OFF)	---	3.548E-5	1.262E-4	3.367E-4	5.983E-3
Average (OFF)	---	1.668E-5	1.066E-4	2.655E-4	3.585E-3
σ (OFF)	---	4.532E-6	1.551E-5	4.199E-5	3.615E-4
Average+3 σ (OFF)	---	3.027E-5	1.531E-4	3.914E-4	4.670E-3
Average-3 σ (OFF)	---	3.083E-6	6.006E-5	1.395E-4	2.501E-3
Average (Bias1)	---	1.931E-5	1.133E-4	3.024E-4	4.578E-3
σ (Bias1)	---	5.533E-6	4.164E-5	9.357E-5	1.437E-3
Average+3 σ (Bias1)	---	3.591E-5	2.382E-4	5.832E-4	8.890E-3
Average-3 σ (Bias1)	---	2.709E-6	-1.168E-5	2.172E-5	2.668E-4
Average (Bias2)	---	1.885E-5	1.322E-4	3.498E-4	5.678E-3
σ (Bias2)	---	1.375E-5	7.975E-6	2.011E-5	5.766E-4
Average+3 σ (Bias2)	---	6.011E-5	1.561E-4	4.101E-4	7.407E-3
Average-3 σ (Bias2)	---	-2.240E-5	1.083E-4	2.895E-4	3.948E-3

60 MeV proton / detailed results

12.CTR3

Ta = 25°C ; IF = 10mA ; Vce = 5V

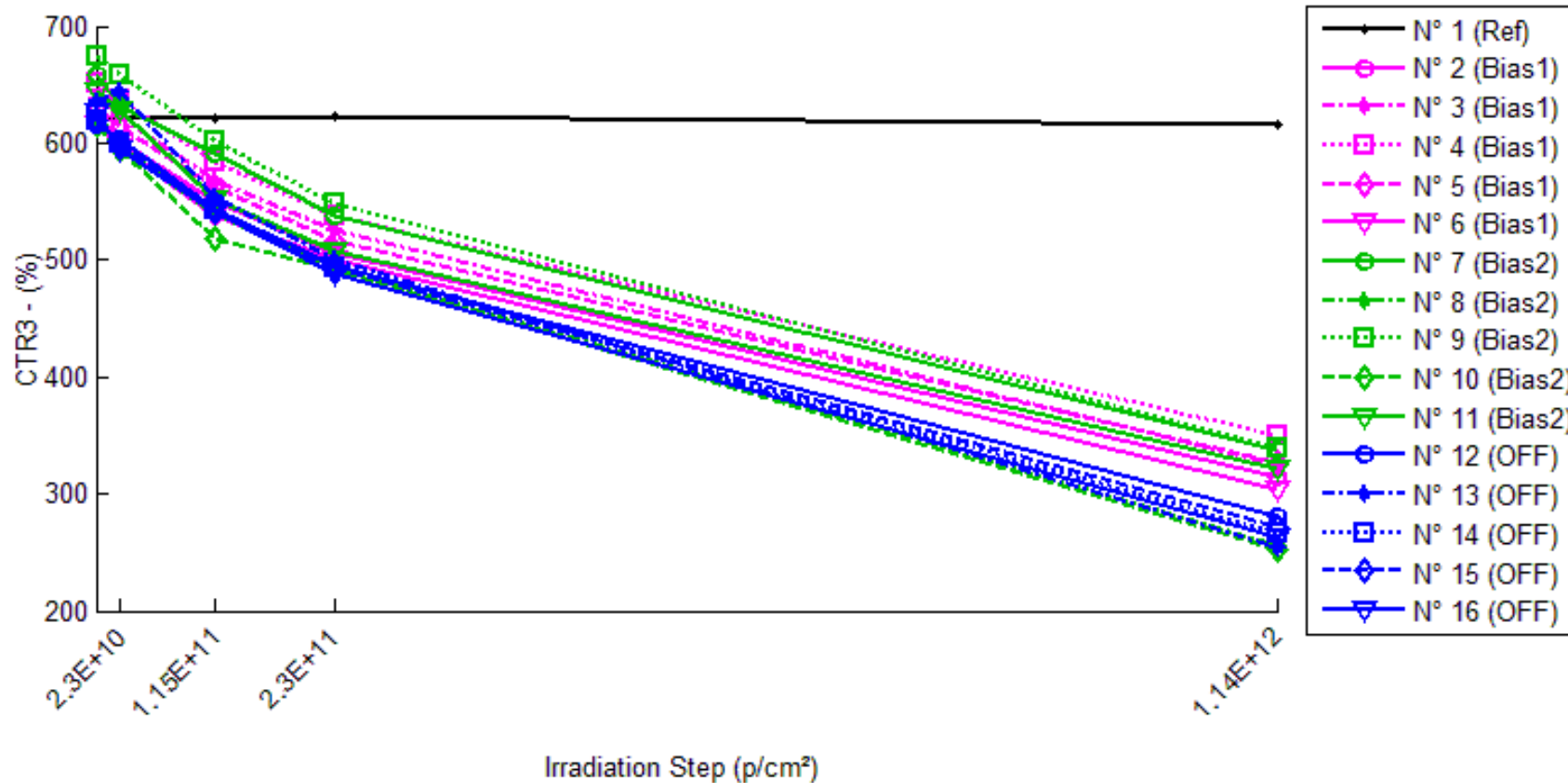

60 MeV proton / detailed results

CTR3 . (%)

	0.p/cm ²	2.3E10.p/cm ²	1.15E11.p/cm ²	2.3E11.p/cm ²	1.14E12.p/cm ²
N° 1 (Ref)	620.82	622.04	621.89	622.09	615.26
N° 2 (Bias1)	620.84	601.65	549.72	505.74	314.10
N° 3 (Bias1)	637.74	622.28	568.45	524.71	325.73
N° 4 (Bias1)	650.96	637.63	584.73	538.51	349.40
N° 5 (Bias1)	629.25	614.79	562.01	517.37	327.14
N° 6 (Bias1)	616.57	596.14	538.55	499.69	303.10
N° 7 (Bias2)	657.53	632.17	591.43	538.49	338.19
N° 8 (Bias2)	614.23	595.90	539.92	492.88	255.48
N° 9 (Bias2)	674.69	657.94	602.42	547.60	339.79
N° 10 (Bias2)	615.16	594.14	518.21	491.34	252.31
N° 11 (Bias2)	643.32	627.62	552.62	506.79	321.06
N° 12 (OFF)	615.28	603.37	543.01	495.12	281.35
N° 13 (OFF)	634.99	644.55	553.82	501.08	254.45
N° 14 (OFF)	619.97	599.21	542.99	492.79	266.44
N° 15 (OFF)	619.81	599.20	542.04	492.90	271.25
N° 16 (OFF)	626.78	594.40	541.15	487.45	262.57

1/Delta [CTR3]

	0.p/cm ²	2.3E10.p/cm ²	1.15E11.p/cm ²	2.3E11.p/cm ²	1.14E12.p/cm ²
N° 1 (Ref)	---	-3.168E-6	-2.769E-6	-3.298E-6	1.456E-5
N° 2 (Bias1)	---	5.140E-5	2.084E-4	3.666E-4	1.573E-3
N° 3 (Bias1)	---	3.894E-5	1.911E-4	3.378E-4	1.502E-3
N° 4 (Bias1)	---	3.212E-5	1.740E-4	3.208E-4	1.326E-3
N° 5 (Bias1)	---	3.738E-5	1.901E-4	3.436E-4	1.468E-3
N° 6 (Bias1)	---	5.558E-5	2.350E-4	3.794E-4	1.677E-3
N° 7 (Bias2)	---	6.101E-5	1.700E-4	3.362E-4	1.436E-3
N° 8 (Bias2)	---	5.009E-5	2.241E-4	4.009E-4	2.286E-3
N° 9 (Bias2)	---	3.774E-5	1.778E-4	3.440E-4	1.461E-3
N° 10 (Bias2)	---	5.751E-5	3.041E-4	4.097E-4	2.338E-3
N° 11 (Bias2)	---	3.889E-5	2.551E-4	4.188E-4	1.560E-3
N° 12 (OFF)	---	3.209E-5	2.163E-4	3.945E-4	1.929E-3
N° 13 (OFF)	---	-2.336E-5	2.308E-4	4.209E-4	2.355E-3
N° 14 (OFF)	---	5.587E-5	2.287E-4	4.163E-4	2.140E-3
N° 15 (OFF)	---	5.552E-5	2.315E-4	4.154E-4	2.073E-3
N° 16 (OFF)	---	8.692E-5	2.525E-4	4.560E-4	2.213E-3
Average (OFF)	---	4.308E-5	1.997E-4	3.496E-4	1.509E-3
σ (OFF)	---	9.940E-6	2.315E-5	2.335E-5	1.302E-4
Average+3 σ (OFF)	---	7.290E-5	2.692E-4	4.197E-4	1.900E-3
Average-3 σ (OFF)	---	1.326E-5	1.303E-4	2.796E-4	1.119E-3
Average (Bias1)	---	4.905E-5	2.262E-4	3.819E-4	1.816E-3
σ (Bias1)	---	1.057E-5	5.571E-5	3.879E-5	4.553E-4
Average+3 σ (Bias1)	---	8.076E-5	3.933E-4	4.983E-4	3.182E-3
Average-3 σ (Bias1)	---	1.733E-5	5.910E-5	2.655E-4	4.503E-4
Average (Bias2)	---	4.141E-5	2.320E-4	4.206E-4	2.142E-3
σ (Bias2)	---	4.111E-5	1.302E-5	2.227E-5	1.586E-4
Average+3 σ (Bias2)	---	1.648E-4	2.710E-4	4.874E-4	2.618E-3
Average-3 σ (Bias2)	---	-8.194E-5	1.929E-4	3.538E-4	1.666E-3

60 MeV proton / detailed results

13.CTR4

Ta = 25°C ; IF = 40mA ; Vce = 5V

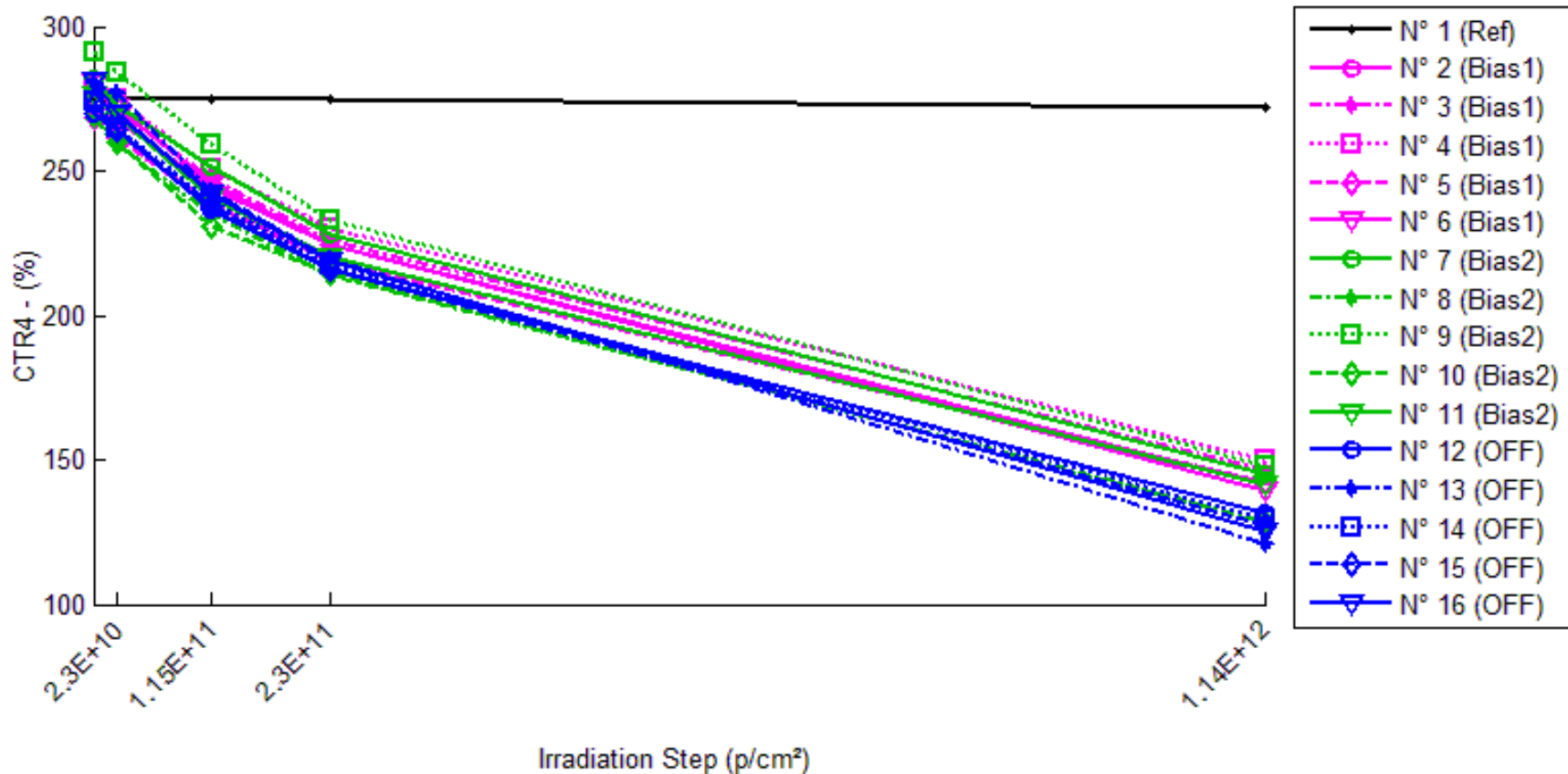

60 MeV proton / detailed results

CTR4 . (%)

	0,p/cm ²	2.3E10.p/cm ²	1.15E11.p/cm ²	2.3E11.p/cm ²	1.14E12.p/cm ²
N° 1 (Ref)	274.16	274.57	274.51	274.54	272.26
N° 2 (Bias1)	276.32	267.97	244.20	224.57	141.41
N° 3 (Bias1)	278.53	271.44	246.97	226.24	146.39
N° 4 (Bias1)	280.80	274.63	250.75	230.42	150.22
N° 5 (Bias1)	268.72	261.59	238.65	218.94	142.53
N° 6 (Bias1)	280.69	271.81	245.51	224.67	139.11
N° 7 (Bias2)	281.95	272.78	251.57	227.77	144.76
N° 8 (Bias2)	268.00	259.32	234.85	213.75	128.41
N° 9 (Bias2)	291.40	284.01	259.09	232.97	148.18
N° 10 (Bias2)	269.65	260.07	230.66	214.53	128.36
N° 11 (Bias2)	276.33	269.44	240.96	220.33	141.21
N° 12 (OFF)	269.55	264.10	236.78	215.98	131.74
N° 13 (OFF)	280.49	277.16	243.26	219.44	121.11
N° 14 (OFF)	274.02	264.99	239.53	217.72	129.49
N° 15 (OFF)	273.40	264.29	238.16	216.19	127.35
N° 16 (OFF)	281.38	269.70	242.51	218.51	124.83

1/Delta [CTR4]

	0,p/cm ²	2.3E10.p/cm ²	1.15E11.p/cm ²	2.3E11.p/cm ²	1.14E12.p/cm ²
N° 1 (Ref)	---	-5.372E-6	-4.666E-6	-5.001E-6	2.547E-5
N° 2 (Bias1)	---	1.128E-4	4.760E-4	8.341E-4	3.453E-3
N° 3 (Bias1)	---	9.373E-5	4.588E-4	8.297E-4	3.241E-3
N° 4 (Bias1)	---	8.008E-5	4.268E-4	7.786E-4	3.096E-3
N° 5 (Bias1)	---	1.014E-4	4.688E-4	8.461E-4	3.295E-3
N° 6 (Bias1)	---	1.163E-4	5.104E-4	8.883E-4	3.626E-3
N° 7 (Bias2)	---	1.192E-4	4.283E-4	8.438E-4	3.361E-3
N° 8 (Bias2)	---	1.248E-4	5.266E-4	9.469E-4	4.056E-3
N° 9 (Bias2)	---	8.934E-5	4.279E-4	8.607E-4	3.317E-3
N° 10 (Bias2)	---	1.367E-4	6.269E-4	9.530E-4	4.082E-3
N° 11 (Bias2)	---	9.250E-5	5.312E-4	9.197E-4	3.463E-3
N° 12 (OFF)	---	7.655E-5	5.135E-4	9.202E-4	3.881E-3
N° 13 (OFF)	---	4.286E-5	5.455E-4	9.918E-4	4.692E-3
N° 14 (OFF)	---	1.243E-4	5.254E-4	9.436E-4	4.073E-3
N° 15 (OFF)	---	1.261E-4	5.411E-4	9.678E-4	4.195E-3
N° 16 (OFF)	---	1.539E-4	5.696E-4	1.022E-3	4.457E-3
Average (OFF)	---	1.009E-4	4.682E-4	8.354E-4	3.342E-3
σ (OFF)	---	1.471E-5	3.019E-5	3.928E-5	2.037E-4
Average+3 σ (OFF)	---	1.450E-4	5.587E-4	9.532E-4	3.953E-3
Average-3 σ (OFF)	---	5.675E-5	3.776E-4	7.175E-4	2.731E-3
Average (Bias1)	---	1.125E-4	5.082E-4	9.048E-4	3.656E-3
σ (Bias1)	---	2.071E-5	8.337E-5	4.997E-5	3.810E-4
Average+3 σ (Bias1)	---	1.746E-4	7.583E-4	1.055E-3	4.799E-3
Average-3 σ (Bias1)	---	5.036E-5	2.581E-4	7.549E-4	2.513E-3
Average (Bias2)	---	1.047E-4	5.390E-4	9.692E-4	4.260E-3
σ (Bias2)	---	4.438E-5	2.131E-5	4.003E-5	3.195E-4
Average+3 σ (Bias2)	---	2.379E-4	6.029E-4	1.089E-3	5.218E-3
Average-3 σ (Bias2)	---	-2.840E-5	4.751E-4	8.491E-4	3.301E-3

60 MeV proton / detailed results

14.CTR5

Ta = 25°C ; IF = 10mA ; Vce = 32V

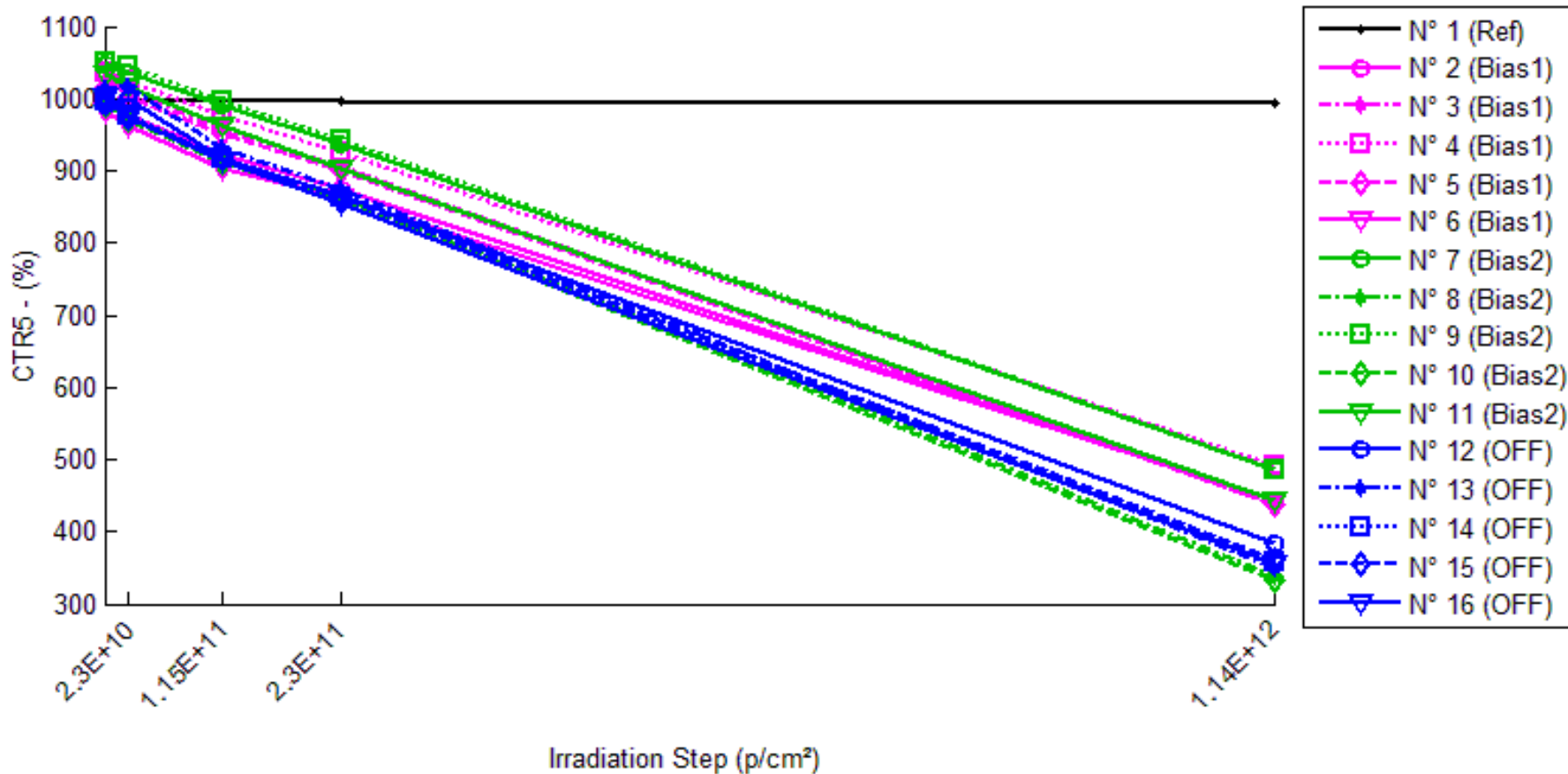

60 MeV proton / detailed results

CTR5 . (%)

	0.p/cm ²	2.3E10.p/cm ²	1.15E11.p/cm ²	2.3E11.p/cm ²	1.14E12.p/cm ²
N° 1 (Ref)	994.112	995.975	996.179	996.454	994.376
N° 2 (Bias1)	996.524	976.767	922.523	874.385	441.922
N° 3 (Bias1)	1024.319	1009.607	955.549	906.847	437.798
N° 4 (Bias1)	1036.678	1026.120	975.729	925.707	491.613
N° 5 (Bias1)	1016.431	1002.801	950.283	899.145	437.865
N° 6 (Bias1)	983.196	962.860	902.894	862.472	444.365
N° 7 (Bias2)	1046.311	1036.334	991.324	936.967	484.826
N° 8 (Bias2)	991.225	974.115	916.639	864.203	337.443
N° 9 (Bias2)	1049.919	1045.134	996.506	942.631	485.680
N° 10 (Bias2)	990.422	970.053	911.325	859.932	333.412
N° 11 (Bias2)	1031.944	1017.394	962.814	902.996	444.014
N° 12 (OFF)	989.740	998.370	917.754	865.085	383.920
N° 13 (OFF)	1013.044	1017.098	932.568	875.035	348.940
N° 14 (OFF)	995.314	975.252	917.857	862.229	357.996
N° 15 (OFF)	994.608	974.723	916.354	861.923	361.918
N° 16 (OFF)	1000.737	975.166	914.269	855.815	354.034

1/Delta [CTR5]

	0.p/cm ²	2.3E10.p/cm ²	1.15E11.p/cm ²	2.3E11.p/cm ²	1.14E12.p/cm ²
N° 1 (Ref)	---	-1.881E-6	-2.088E-6	-2.364E-6	-2.670E-7
N° 2 (Bias1)	---	2.030E-5	8.050E-5	1.402E-4	1.259E-3
N° 3 (Bias1)	---	1.423E-5	7.026E-5	1.265E-4	1.308E-3
N° 4 (Bias1)	---	9.925E-6	6.025E-5	1.156E-4	1.069E-3
N° 5 (Bias1)	---	1.337E-5	6.848E-5	1.283E-4	1.300E-3
N° 6 (Bias1)	---	2.148E-5	9.046E-5	1.424E-4	1.233E-3
N° 7 (Bias2)	---	9.201E-6	5.301E-5	1.115E-4	1.107E-3
N° 8 (Bias2)	---	1.772E-5	8.209E-5	1.483E-4	1.955E-3
N° 9 (Bias2)	---	4.361E-6	5.105E-5	1.084E-4	1.107E-3
N° 10 (Bias2)	---	2.120E-5	8.763E-5	1.532E-4	1.990E-3
N° 11 (Bias2)	---	1.386E-5	6.958E-5	1.384E-4	1.283E-3
N° 12 (OFF)	---	-8.734E-6	7.925E-5	1.456E-4	1.594E-3
N° 13 (OFF)	---	-3.935E-6	8.518E-5	1.557E-4	1.879E-3
N° 14 (OFF)	---	2.067E-5	8.479E-5	1.551E-4	1.789E-3
N° 15 (OFF)	---	2.051E-5	8.586E-5	1.548E-4	1.758E-3
N° 16 (OFF)	---	2.620E-5	9.451E-5	1.692E-4	1.825E-3
Average (OFF)	---	1.586E-5	7.399E-5	1.306E-4	1.234E-3
σ (OFF)	---	4.883E-6	1.169E-5	1.091E-5	9.685E-5
Average+3 σ (OFF)	---	3.051E-5	1.091E-4	1.633E-4	1.525E-3
Average-3 σ (OFF)	---	1.211E-6	3.893E-5	9.786E-5	9.435E-4
Average (Bias1)	---	1.327E-5	6.867E-5	1.320E-4	1.488E-3
σ (Bias1)	---	6.689E-6	1.655E-5	2.080E-5	4.478E-4
Average+3 σ (Bias1)	---	3.334E-5	1.183E-4	1.944E-4	2.832E-3
Average-3 σ (Bias1)	---	-6.800E-6	1.901E-5	6.955E-5	1.447E-4
Average (Bias2)	---	1.094E-5	8.592E-5	1.561E-4	1.769E-3
σ (Bias2)	---	1.603E-5	5.479E-6	8.447E-6	1.075E-4
Average+3 σ (Bias2)	---	5.902E-5	1.024E-4	1.814E-4	2.091E-3
Average-3 σ (Bias2)	---	-3.714E-5	6.948E-5	1.307E-4	1.446E-3

60 MeV proton / detailed results

15.TRR

Ta = 25°C ; IF = 2mA ; RL = 100 Ohms ; Irec = 10% Irm

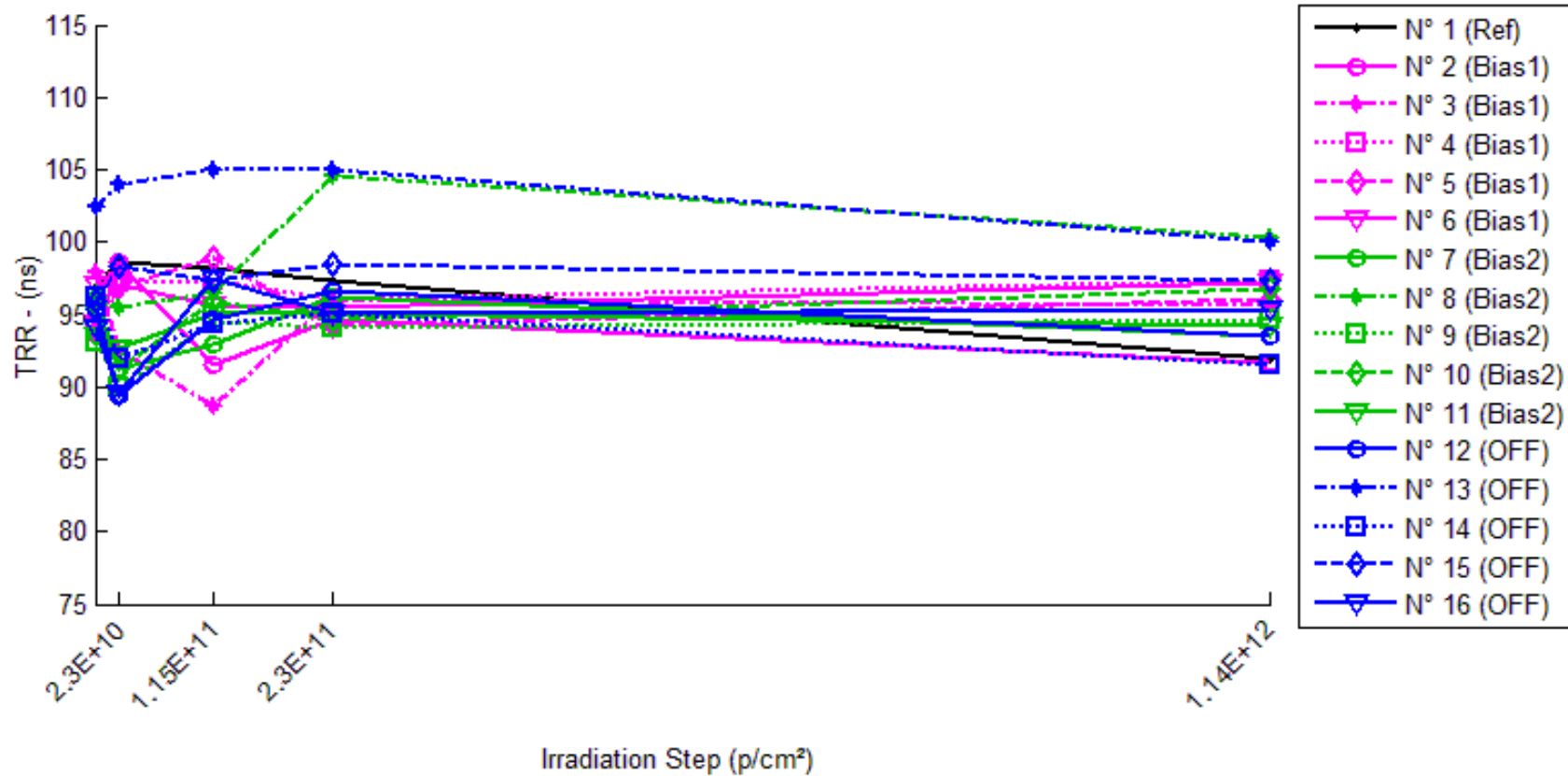

60 MeV proton / detailed results

TRR . (ns)

	0.p/cm ²	2.3E10.p/cm ²	1.15E11.p/cm ²	2.3E11.p/cm ²	1.14E12.p/cm ²
N° 1 (Ref)	96.95	98.62	98.20	97.38	92.00
N° 2 (Bias1)	93.62	98.64	91.54	94.62	91.67
N° 3 (Bias1)	97.94	92.50	88.75	96.08	95.68
N° 4 (Bias1)	94.17	97.24	97.33	96.08	97.30
N° 5 (Bias1)	93.85	96.86	98.85	94.26	96.13
N° 6 (Bias1)	97.03	97.03	95.59	95.56	97.21
N° 7 (Bias2)	95.52	91.29	92.90	96.17	93.47
N° 8 (Bias2)	96.13	95.52	96.45	104.55	100.29
N° 9 (Bias2)	93.08	90.00	94.53	94.12	94.65
N° 10 (Bias2)	96.14	91.29	95.98	94.58	96.75
N° 11 (Bias2)	93.53	92.68	95.04	95.04	94.21
N° 12 (OFF)	95.36	89.42	94.67	96.69	93.49
N° 13 (OFF)	102.49	104.00	104.97	104.98	100.00
N° 14 (OFF)	96.26	92.00	94.31	95.02	91.54
N° 15 (OFF)	95.95	98.36	97.35	98.53	97.32
N° 16 (OFF)	94.09	89.50	97.51	95.04	95.42

Delta [TRR]

	0.p/cm ²	2.3E10.p/cm ²	1.15E11.p/cm ²	2.3E11.p/cm ²	1.14E12.p/cm ²
N° 1 (Ref)	---	1.676E+0	1.252E+0	4.356E-1	-4.947E+0
N° 2 (Bias1)	---	5.026E+0	-2.075E+0	1.002E+0	-1.950E+0
N° 3 (Bias1)	---	-5.442E+0	-9.192E+0	-1.859E+0	-2.263E+0
N° 4 (Bias1)	---	3.071E+0	3.160E+0	1.917E+0	3.131E+0
N° 5 (Bias1)	---	3.015E+0	5.006E+0	4.182E-1	2.286E+0
N° 6 (Bias1)	---	0.000E+0	-1.441E+0	-1.474E+0	1.834E-1
N° 7 (Bias2)	---	-4.235E+0	-2.626E+0	6.525E-1	-2.050E+0
N° 8 (Bias2)	---	-6.102E-1	3.213E-1	8.413E+0	4.159E+0
N° 9 (Bias2)	---	-3.077E+0	1.450E+0	1.041E+0	1.573E+0
N° 10 (Bias2)	---	-4.853E+0	-1.651E-1	-1.559E+0	6.059E-1
N° 11 (Bias2)	---	-8.465E-1	1.506E+0	1.512E+0	6.822E-1
N° 12 (OFF)	---	-5.935E+0	-6.894E-1	1.329E+0	-1.869E+0
N° 13 (OFF)	---	1.512E+0	2.485E+0	2.493E+0	-2.488E+0
N° 14 (OFF)	---	-4.259E+0	-1.947E+0	-1.240E+0	-4.717E+0
N° 15 (OFF)	---	2.407E+0	1.397E+0	2.580E+0	1.364E+0
N° 16 (OFF)	---	-4.587E+0	3.417E+0	9.493E-1	1.330E+0
Average (OFF)	---	1.134E+0	-9.084E-1	7.800E-4	2.774E-1
σ (OFF)	---	4.092E+0	5.518E+0	1.619E+0	2.429E+0
Average+3σ (OFF)	---	1.341E+1	1.565E+1	4.857E+0	7.565E+0
Average-3σ (OFF)	---	-1.114E+1	-1.746E+1	-4.855E+0	-7.010E+0
Average (Bias1)	---	-2.724E+0	9.729E-2	2.012E+0	9.941E-1
σ (Bias1)	---	1.932E+0	1.685E+0	3.767E+0	2.228E+0
Average+3σ (Bias1)	---	3.072E+0	5.151E+0	1.331E+1	7.680E+0
Average-3σ (Bias1)	---	-8.521E+0	-4.957E+0	-9.290E+0	-5.691E+0
Average (Bias2)	---	-2.172E+0	9.326E-1	1.222E+0	-1.276E+0
σ (Bias2)	---	3.837E+0	2.220E+0	1.550E+0	2.618E+0
Average+3σ (Bias2)	---	9.338E+0	7.593E+0	5.872E+0	6.579E+0
Average-3σ (Bias2)	---	-1.368E+1	-5.728E+0	-3.427E+0	-9.131E+0

190 MeV proton / detailed results

CONTENTS

1. Ic(on)	2
2. CTR1	4
3. Vce(sat)	6
4. BVceo	8
5. BVeco	10
6. Ice(off)	12
7. VF	14
8. Ir	16
9. TR	18
10. TF	20
11. CTR2	22
12. CTR3	24
13. CTR4	26
14. CTR5	28
15. TRR	30

190 MeV proton / detailed results

1. Ic(on)

Ta = 25°C ; IF = 1mA ; Vce = 5V

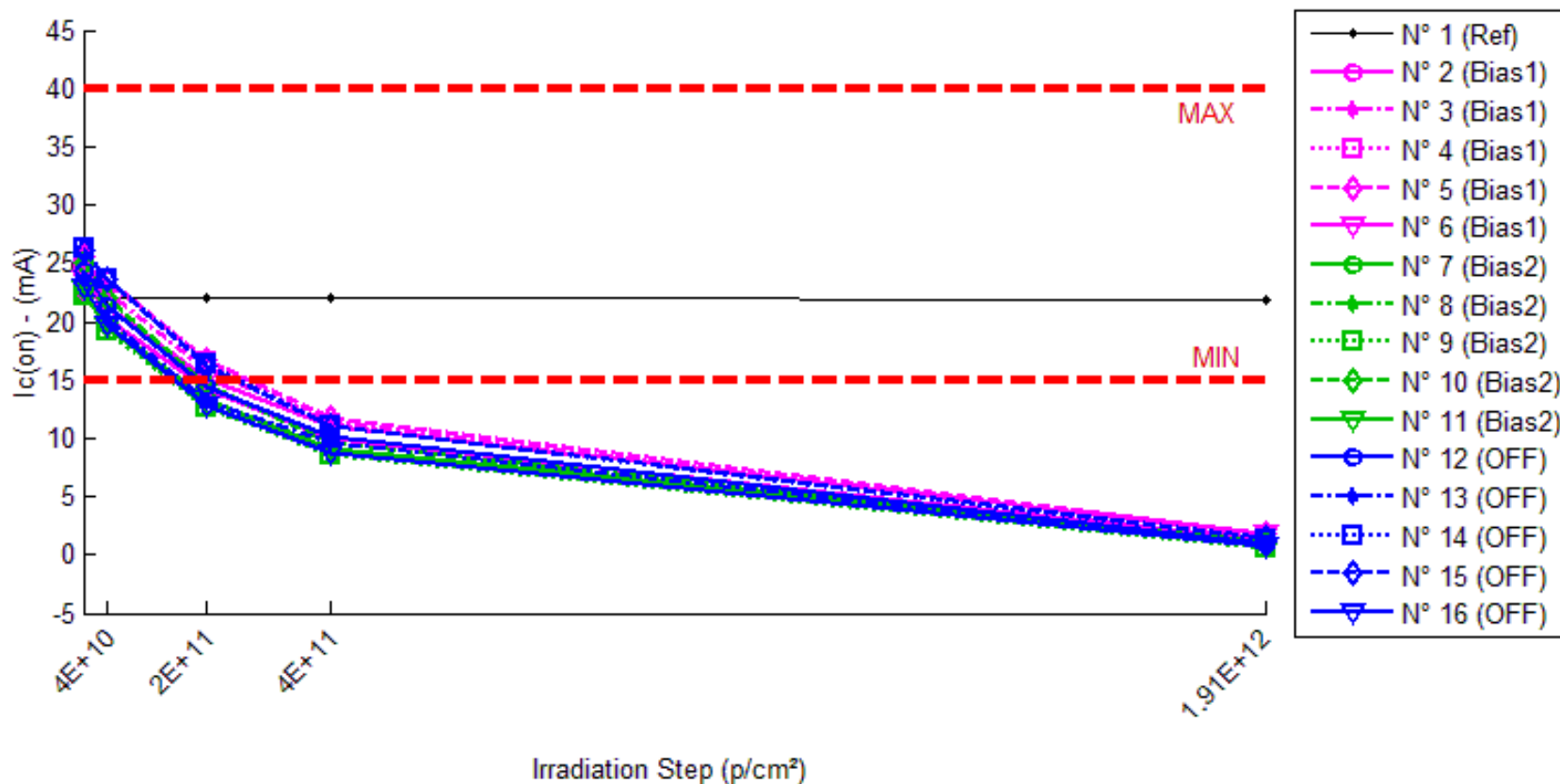

190 MeV proton / detailed results

Ic(on) . (mA)

Min = 15.0 Max = 40.0

	0.p/cm ²	4E10.p/cm ²	2E11.p/cm ²	4E11.p/cm ²	1.91E12.p/cm ²
N° 1 (Ref)	22.001	22.009	22.010	21.970	21.947
N° 2 (Bias1)	22.557	20.252	14.154	10.032	1.317
N° 3 (Bias1)	24.992	22.519	15.843	11.366	1.579
N° 4 (Bias1)	25.217	23.464	16.534	11.167	1.584
N° 5 (Bias1)	25.531	23.607	16.698	11.692	1.842
N° 6 (Bias1)	23.565	21.259	15.118	11.028	1.754
N° 7 (Bias2)	22.186	19.793	13.408	9.027	1.066
N° 8 (Bias2)	22.549	19.568	12.966	8.893	0.713
N° 9 (Bias2)	22.165	19.229	12.690	8.617	0.663
N° 10 (Bias2)	25.029	22.086	14.527	9.653	0.977
N° 11 (Bias2)	22.706	19.547	12.904	8.725	0.733
N° 12 (OFF)	24.314	21.301	14.410	10.077	0.934
N° 13 (OFF)	23.576	20.191	13.176	9.624	0.790
N° 14 (OFF)	26.206	23.599	16.323	11.009	1.239
N° 15 (OFF)	26.106	23.556	16.214	11.099	1.496
N° 16 (OFF)	22.873	19.751	12.874	8.707	0.690

Delta [Ic(on)]

	0.p/cm ²	4E10.p/cm ²	2E11.p/cm ²	4E11.p/cm ²	1.91E12.p/cm ²
N° 1 (Ref)	---	7.830E-3	8.670E-3	-3.076E-2	-5.414E-2
N° 2 (Bias1)	---	-2.305E+0	-8.403E+0	-1.252E+1	-2.124E+1
N° 3 (Bias1)	---	-2.473E+0	-9.149E+0	-1.363E+1	-2.341E+1
N° 4 (Bias1)	---	-1.753E+0	-8.683E+0	-1.405E+1	-2.363E+1
N° 5 (Bias1)	---	-1.924E+0	-8.833E+0	-1.384E+1	-2.369E+1
N° 6 (Bias1)	---	-2.306E+0	-8.447E+0	-1.254E+1	-2.181E+1
N° 7 (Bias2)	---	-2.392E+0	-8.778E+0	-1.316E+1	-2.112E+1
N° 8 (Bias2)	---	-2.981E+0	-9.584E+0	-1.366E+1	-2.184E+1
N° 9 (Bias2)	---	-2.936E+0	-9.476E+0	-1.355E+1	-2.150E+1
N° 10 (Bias2)	---	-2.943E+0	-1.050E+1	-1.538E+1	-2.405E+1
N° 11 (Bias2)	---	-3.158E+0	-9.801E+0	-1.398E+1	-2.197E+1
N° 12 (OFF)	---	-3.013E+0	-9.904E+0	-1.424E+1	-2.338E+1
N° 13 (OFF)	---	-3.385E+0	-1.040E+1	-1.395E+1	-2.279E+1
N° 14 (OFF)	---	-2.607E+0	-9.883E+0	-1.520E+1	-2.497E+1
N° 15 (OFF)	---	-2.550E+0	-9.892E+0	-1.501E+1	-2.461E+1
N° 16 (OFF)	---	-3.122E+0	-9.998E+0	-1.417E+1	-2.218E+1
Average (Bias1)	---	-2.152E+0	-8.703E+0	-1.332E+1	-2.276E+1
σ (Bias1)	---	3.004E-1	3.049E-1	7.318E-1	1.147E+0
Average+3σ (Bias1)	---	-1.251E+0	-7.788E+0	-1.112E+1	-1.932E+1
Average-3σ (Bias1)	---	-3.053E+0	-9.618E+0	-1.551E+1	-2.620E+1
Average (Bias2)	---	-2.882E+0	-9.628E+0	-1.394E+1	-2.210E+1
σ (Bias2)	---	2.885E-1	6.212E-1	8.529E-1	1.142E+0
Average+3σ (Bias2)	---	-2.017E+0	-7.765E+0	-1.139E+1	-1.867E+1
Average-3σ (Bias2)	---	-3.748E+0	-1.149E+1	-1.650E+1	-2.552E+1
Average (OFF)	---	-2.935E+0	-1.002E+1	-1.451E+1	-2.359E+1
σ (OFF)	---	3.534E-1	2.199E-1	5.531E-1	1.184E+0
Average+3σ (OFF)	---	-1.875E+0	-9.356E+0	-1.285E+1	-2.003E+1
Average-3σ (OFF)	---	-3.996E+0	-1.067E+1	-1.617E+1	-2.714E+1

190 MeV proton / detailed results

2. CTR1

Ta = 25°C ; IF = 1mA ; Vce = 5V

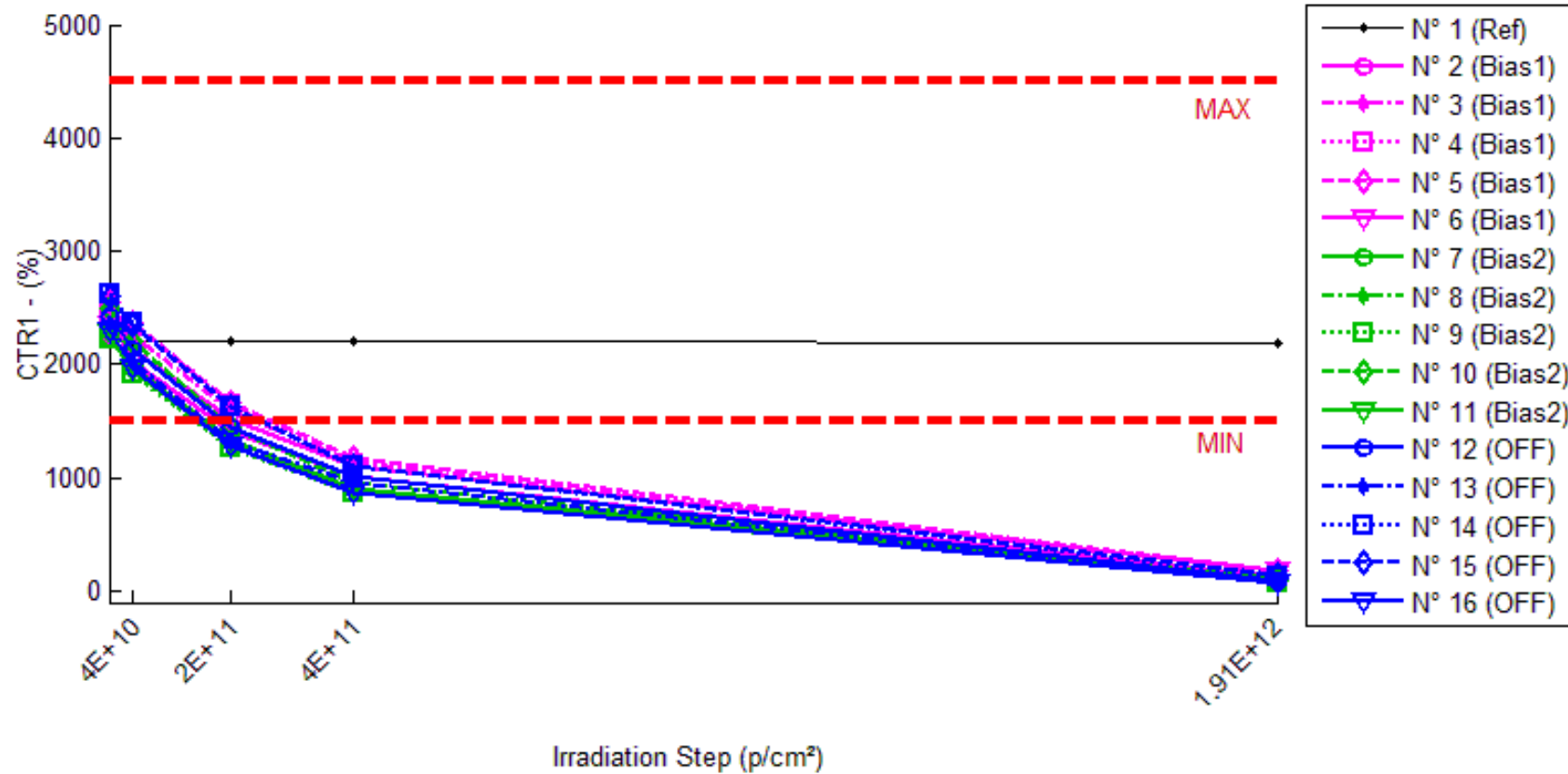

190 MeV proton / detailed results

CTR1 . (%)

Min = 1500.0 Max = 4000.0

	0,p/cm ²	4E10,p/cm ²	2E11,p/cm ²	4E11,p/cm ²	1.91E12,p/cm ²
N° 1 (Ref)	2200.11	2200.89	2200.98	2197.04	2194.70
N° 2 (Bias1)	2255.69	2025.19	1415.40	1003.23	131.67
N° 3 (Bias1)	2499.20	2251.94	1584.33	1136.61	157.89
N° 4 (Bias1)	2521.73	2346.42	1653.42	1116.75	158.37
N° 5 (Bias1)	2553.15	2360.74	1669.80	1169.16	184.25
N° 6 (Bias1)	2356.52	2125.94	1511.84	1102.83	175.41
N° 7 (Bias2)	2218.57	1979.35	1340.81	902.70	106.63
N° 8 (Bias2)	2254.92	1956.79	1296.55	889.26	71.35
N° 9 (Bias2)	2216.54	1922.92	1268.97	861.75	66.29
N° 10 (Bias2)	2502.93	2208.63	1452.67	965.27	97.68
N° 11 (Bias2)	2270.55	1954.71	1290.41	872.50	73.28
N° 12 (OFF)	2431.38	2130.08	1441.00	1007.73	93.38
N° 13 (OFF)	2357.61	2019.08	1317.61	962.40	79.01
N° 14 (OFF)	2620.61	2359.89	1632.30	1100.86	123.90
N° 15 (OFF)	2610.55	2355.56	1621.37	1109.92	149.61
N° 16 (OFF)	2287.27	1975.09	1287.44	870.71	68.95

1/Delta [CTR1]

	0,p/cm ²	4E10,p/cm ²	2E11,p/cm ²	4E11,p/cm ²	1.91E12,p/cm ²
N° 1 (Ref)	---	-1.617E-7	-1.790E-7	6.364E-7	1.121E-6
N° 2 (Bias1)	---	5.046E-5	2.632E-4	5.535E-4	7.152E-3
N° 3 (Bias1)	---	4.393E-5	2.311E-4	4.797E-4	5.933E-3
N° 4 (Bias1)	---	2.963E-5	2.083E-4	4.989E-4	5.918E-3
N° 5 (Bias1)	---	3.192E-5	2.072E-4	4.636E-4	5.036E-3
N° 6 (Bias1)	---	4.603E-5	2.371E-4	4.824E-4	5.277E-3
N° 7 (Bias2)	---	5.448E-5	2.951E-4	6.570E-4	8.927E-3
N° 8 (Bias2)	---	6.757E-5	3.278E-4	6.811E-4	1.357E-2
N° 9 (Bias2)	---	6.889E-5	3.369E-4	7.093E-4	1.463E-2
N° 10 (Bias2)	---	5.324E-5	2.889E-4	6.364E-4	9.837E-3
N° 11 (Bias2)	---	7.116E-5	3.345E-4	7.057E-4	1.320E-2
N° 12 (OFF)	---	5.818E-5	2.827E-4	5.810E-4	1.030E-2
N° 13 (OFF)	---	7.112E-5	3.348E-4	6.149E-4	1.223E-2
N° 14 (OFF)	---	4.216E-5	2.310E-4	5.268E-4	7.689E-3
N° 15 (OFF)	---	4.147E-5	2.337E-4	5.179E-4	6.301E-3
N° 16 (OFF)	---	6.911E-5	3.395E-4	7.113E-4	1.407E-2
Average (Bias1)	---	4.039E-5	2.294E-4	4.956E-4	5.863E-3
σ (Bias1)	---	9.126E-6	2.315E-5	3.467E-5	8.211E-4
Average+3σ (Bias1)	---	6.777E-5	2.988E-4	5.996E-4	8.326E-3
Average-3σ (Bias1)	---	1.301E-5	1.599E-4	3.916E-4	3.400E-3
Average (Bias2)	---	6.307E-5	3.166E-4	6.779E-4	1.204E-2
σ (Bias2)	---	8.516E-6	2.286E-5	3.131E-5	2.499E-3
Average+3σ (Bias2)	---	8.861E-5	3.852E-4	7.718E-4	1.953E-2
Average-3σ (Bias2)	---	3.752E-5	2.480E-4	5.840E-4	4.539E-3
Average (OFF)	---	5.640E-5	2.843E-4	5.904E-4	1.012E-2
σ (OFF)	---	1.420E-5	5.244E-5	7.843E-5	3.184E-3
Average+3σ (OFF)	---	9.902E-5	4.417E-4	8.257E-4	1.967E-2
Average-3σ (OFF)	---	1.379E-5	1.270E-4	3.551E-4	5.648E-3

190 MeV proton / detailed results

3. Vce(sat)

Ta = 25°C ; IF = 1mA ; Ic = 2mA

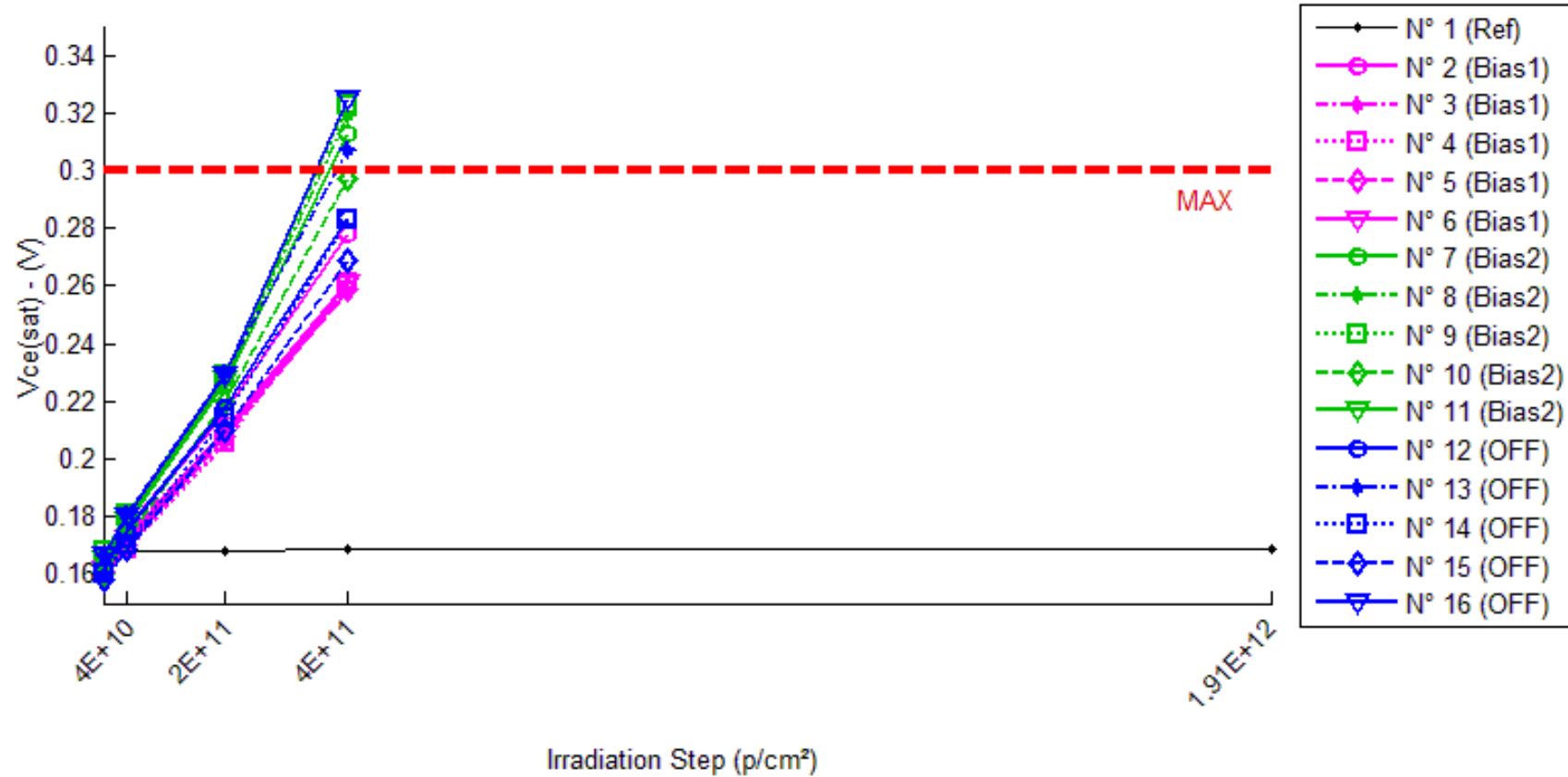

190 MeV proton / detailed results

Vce(sat) . (V)

Max = 0.3

	0.p/cm ²	4E10.p/cm ²	2E11.p/cm ²	4E11.p/cm ²	1.91E12.p/cm ²
N° 1 (Ref)	0.168	0.168	0.168	0.169	0.169
N° 2 (Bias1)	0.164	0.176	0.216	0.278	Not Measurable
N° 3 (Bias1)	0.163	0.174	0.209	0.258	Not Measurable
N° 4 (Bias1)	0.160	0.169	0.206	0.261	Not Measurable
N° 5 (Bias1)	0.161	0.170	0.208	0.259	Not Measurable
N° 6 (Bias1)	0.162	0.172	0.210	0.261	Not Measurable
N° 7 (Bias2)	0.165	0.177	0.226	0.313	Not Measurable
N° 8 (Bias2)	0.164	0.179	0.228	0.319	Not Measurable
N° 9 (Bias2)	0.168	0.181	0.229	0.323	Not Measurable
N° 10 (Bias2)	0.160	0.172	0.220	0.297	Not Measurable
N° 11 (Bias2)	0.165	0.179	0.228	0.325	Not Measurable
N° 12 (OFF)	0.162	0.175	0.218	0.284	Not Measurable
N° 13 (OFF)	0.167	0.181	0.230	0.307	Not Measurable
N° 14 (OFF)	0.160	0.170	0.214	0.283	Not Measurable
N° 15 (OFF)	0.158	0.169	0.210	0.269	Not Measurable
N° 16 (OFF)	0.167	0.180	0.229	0.325	Not Measurable

Delta [Vce(sat)]

	0.p/cm ²	4E10.p/cm ²	2E11.p/cm ²	4E11.p/cm ²	1.91E12.p/cm ²
N° 1 (Ref)	---	1.538E-4	3.021E-4	5.910E-4	6.543E-4
N° 2 (Bias1)	---	1.250E-2	5.212E-2	1.142E-1	1.433E+2
N° 3 (Bias1)	---	1.147E-2	4.654E-2	9.515E-2	1.419E+2
N° 4 (Bias1)	---	8.535E-3	4.554E-2	1.006E-1	1.300E+2
N° 5 (Bias1)	---	8.769E-3	4.649E-2	9.828E-2	1.267E+2
N° 6 (Bias1)	---	1.042E-2	4.842E-2	9.977E-2	1.366E+2
N° 7 (Bias2)	---	1.229E-2	6.086E-2	1.480E-1	1.405E+2
N° 8 (Bias2)	---	1.492E-2	6.436E-2	1.554E-1	1.512E+2
N° 9 (Bias2)	---	1.357E-2	6.111E-2	1.560E-1	1.520E+2
N° 10 (Bias2)	---	1.209E-2	6.025E-2	1.370E-1	1.416E+2
N° 11 (Bias2)	---	1.413E-2	6.377E-2	1.604E-1	1.507E+2
N° 12 (OFF)	---	1.324E-2	5.629E-2	1.224E-1	1.486E+2
N° 13 (OFF)	---	1.317E-2	6.271E-2	1.393E-1	1.513E+2
N° 14 (OFF)	---	9.637E-3	5.352E-2	1.223E-1	1.323E+2
N° 15 (OFF)	---	1.018E-2	5.206E-2	1.103E-1	1.328E+2
N° 16 (OFF)	---	1.346E-2	6.230E-2	1.588E-1	1.523E+2
Average (Bias1)	---	1.034E-2	4.782E-2	1.016E-1	1.357E+2
σ (Bias1)	---	1.707E-3	2.619E-3	7.345E-3	7.265E+0
Average+3σ (Bias1)	---	1.546E-2	5.568E-2	1.236E-1	1.575E+2
Average-3σ (Bias1)	---	5.217E-3	3.996E-2	7.957E-2	1.139E+2
Average (Bias2)	---	1.340E-2	6.207E-2	1.514E-1	1.472E+2
σ (Bias2)	---	1.207E-3	1.859E-3	9.198E-3	5.644E+0
Average+3σ (Bias2)	---	1.702E-2	6.764E-2	1.790E-1	1.641E+2
Average-3σ (Bias2)	---	9.778E-3	5.649E-2	1.238E-1	1.303E+2
Average (OFF)	---	1.194E-2	5.738E-2	1.306E-1	1.435E+2
σ (OFF)	---	1.864E-3	4.923E-3	1.884E-2	1.005E+1
Average+3σ (OFF)	---	1.753E-2	7.215E-2	1.872E-1	1.736E+2
Average-3σ (OFF)	---	6.343E-3	4.261E-2	7.413E-2	1.133E+2

190 MeV proton / detailed results

4. BV_{ceo}

T_a = 25°C ; I_{ce} = 1mA

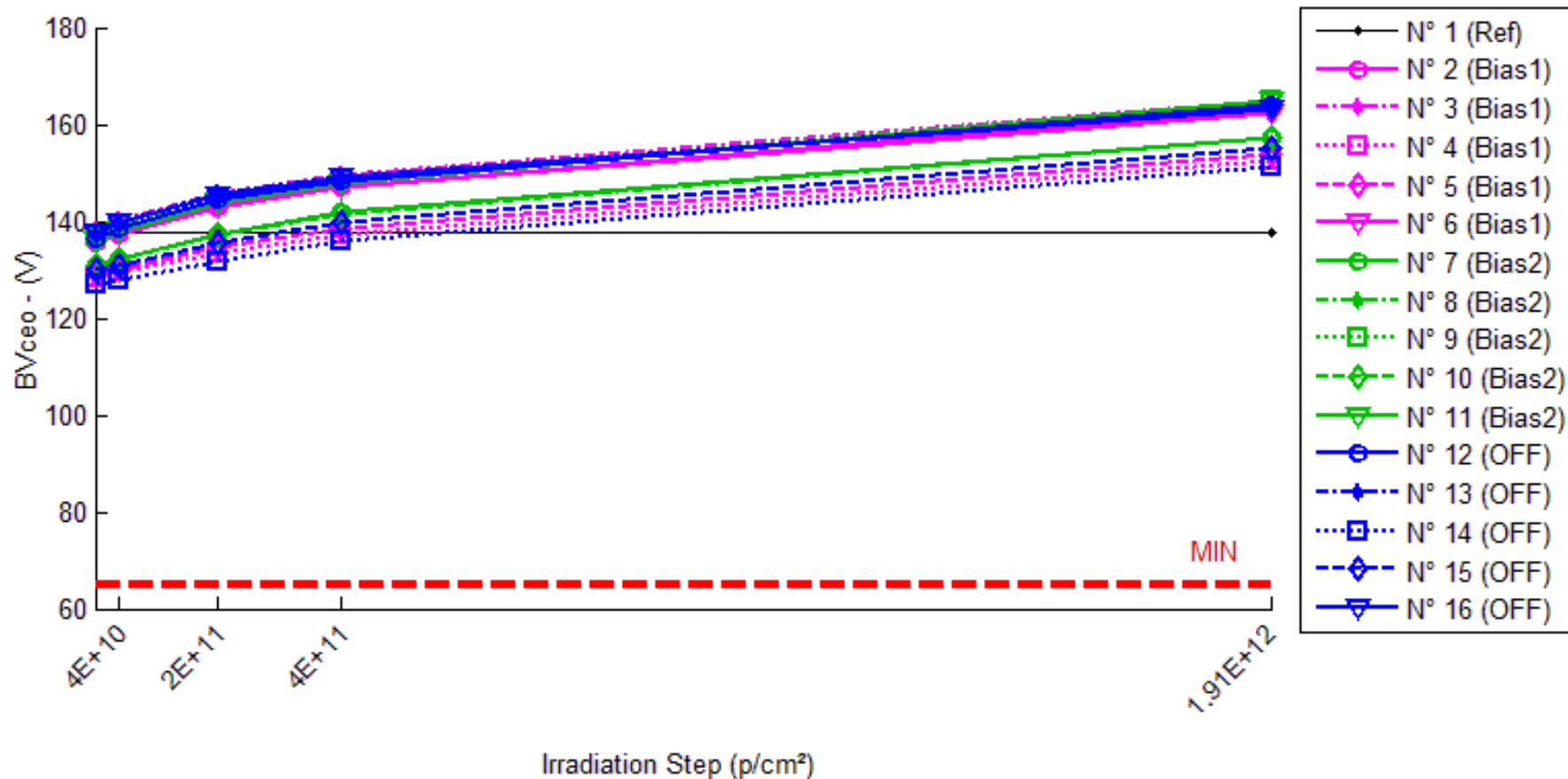

190 MeV proton / detailed results

BVceo . (V) Min = 65.0

	0.p/cm ²	4E10.p/cm ²	2E11.p/cm ²	4E11.p/cm ²	1.91E12.p/cm ²
N° 1 (Ref)	137.562	137.582	137.707	137.617	137.607
N° 2 (Bias1)	135.335	137.271	142.957	147.148	163.197
N° 3 (Bias1)	138.245	140.405	145.820	149.607	165.082
N° 4 (Bias1)	128.458	129.445	133.411	137.284	152.382
N° 5 (Bias1)	129.188	130.198	134.577	138.396	153.735
N° 6 (Bias1)	136.058	137.717	143.064	146.907	162.454
N° 7 (Bias2)	130.969	132.227	137.214	141.725	157.342
N° 8 (Bias2)	135.192	137.495	143.629	147.721	165.010
N° 9 (Bias2)	136.982	139.236	144.880	148.661	164.777
N° 10 (Bias2)	130.878	132.211	137.258	141.550	157.240
N° 11 (Bias2)	135.761	138.072	143.836	147.693	164.683
N° 12 (OFF)	136.234	138.450	144.386	148.194	163.990
N° 13 (OFF)	137.086	139.755	145.859	149.178	163.696
N° 14 (OFF)	127.131	128.002	131.735	135.942	151.413
N° 15 (OFF)	129.846	130.952	135.642	139.893	155.212
N° 16 (OFF)	137.491	139.647	145.338	149.230	163.100

Delta [BVceo]

	0.p/cm ²	4E10.p/cm ²	2E11.p/cm ²	4E11.p/cm ²	1.91E12.p/cm ²
N° 1 (Ref)	---	2.010E-2	1.450E-1	5.420E-2	4.420E-2
N° 2 (Bias1)	---	1.936E+0	7.621E+0	1.181E+1	2.786E+1
N° 3 (Bias1)	---	2.160E+0	7.575E+0	1.136E+1	2.684E+1
N° 4 (Bias1)	---	9.866E-1	4.953E+0	8.826E+0	2.392E+1
N° 5 (Bias1)	---	1.010E+0	5.389E+0	9.208E+0	2.455E+1
N° 6 (Bias1)	---	1.659E+0	7.005E+0	1.085E+1	2.640E+1
N° 7 (Bias2)	---	1.259E+0	6.245E+0	1.076E+1	2.637E+1
N° 8 (Bias2)	---	2.303E+0	8.437E+0	1.253E+1	2.982E+1
N° 9 (Bias2)	---	2.254E+0	7.898E+0	1.168E+1	2.780E+1
N° 10 (Bias2)	---	1.333E+0	6.381E+0	1.067E+1	2.636E+1
N° 11 (Bias2)	---	2.311E+0	8.075E+0	1.193E+1	2.892E+1
N° 12 (OFF)	---	2.215E+0	8.152E+0	1.196E+1	2.776E+1
N° 13 (OFF)	---	2.669E+0	8.774E+0	1.209E+1	2.661E+1
N° 14 (OFF)	---	8.716E-1	4.604E+0	8.812E+0	2.428E+1
N° 15 (OFF)	---	1.107E+0	5.796E+0	1.005E+1	2.537E+1
N° 16 (OFF)	---	2.156E+0	7.847E+0	1.174E+1	2.561E+1
Average (Bias1)	---	1.550E+0	6.509E+0	1.041E+1	2.591E+1
σ (Bias1)	---	5.344E-1	1.255E+0	1.325E+0	1.636E+0
Average+3σ (Bias1)	---	3.153E+0	1.027E+1	1.439E+1	3.082E+1
Average-3σ (Bias1)	---	-5.297E-2	2.745E+0	6.437E+0	2.101E+1
Average (Bias2)	---	1.892E+0	7.407E+0	1.151E+1	2.785E+1
σ (Bias2)	---	5.451E-1	1.019E+0	7.930E-1	1.534E+0
Average+3σ (Bias2)	---	3.527E+0	1.046E+1	1.389E+1	3.246E+1
Average-3σ (Bias2)	---	2.568E-1	4.351E+0	9.135E+0	2.325E+1
Average (OFF)	---	1.804E+0	7.035E+0	1.093E+1	2.592E+1
σ (OFF)	---	7.742E-1	1.759E+0	1.444E+0	1.316E+0
Average+3σ (OFF)	---	4.126E+0	1.231E+1	1.526E+1	2.987E+1
Average-3σ (OFF)	---	-5.189E-1	1.757E+0	6.599E+0	2.198E+1

190 MeV proton / detailed results

5. BV_{eco}

T_a = 25°C ; I_{ec} = 100μA

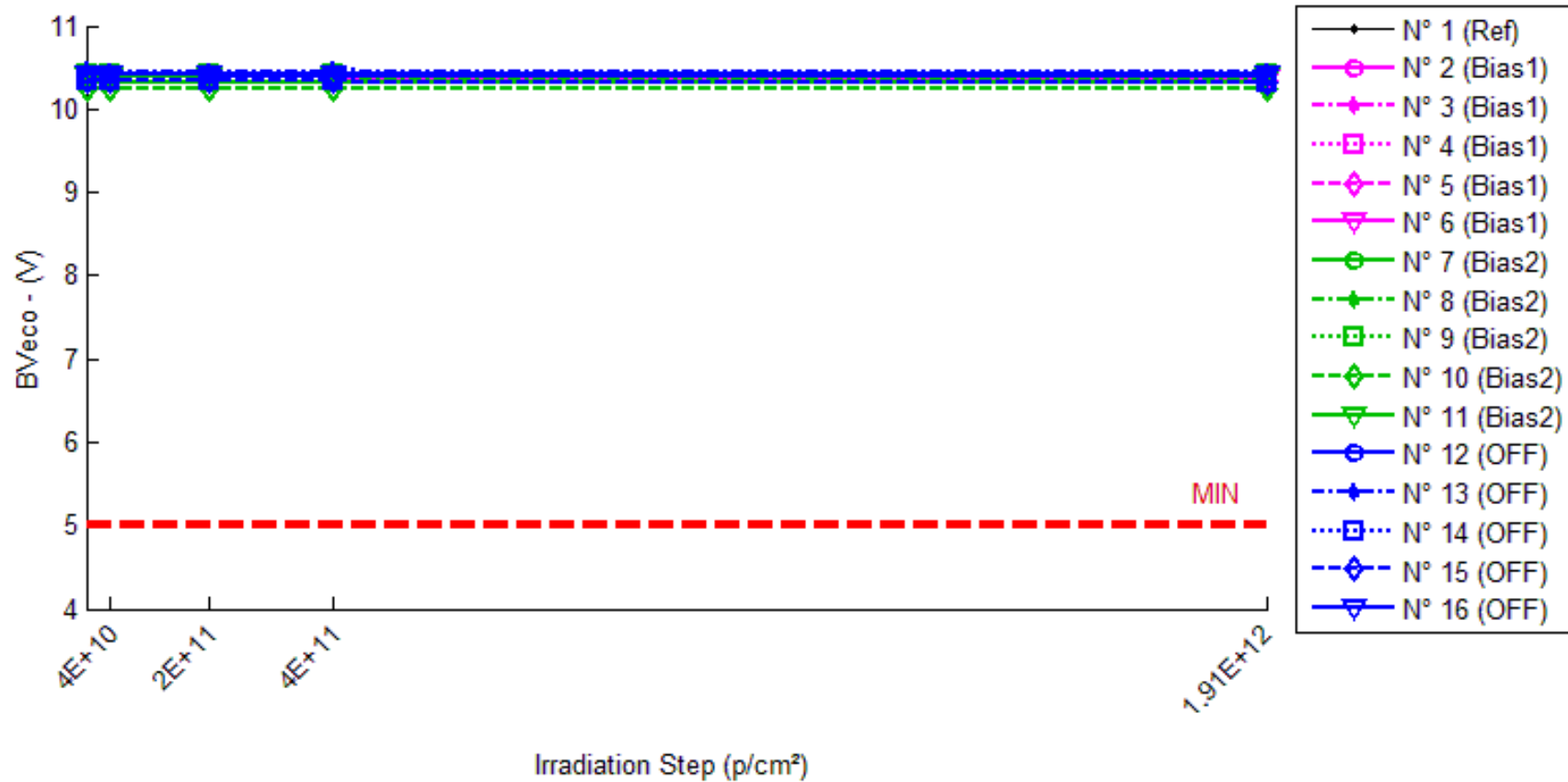

190 MeV proton / detailed results

BVeco . (V)

Min = 5.0

	0,p/cm ²	4E10.p/cm ²	2E11.p/cm ²	4E11.p/cm ²	1.91E12.p/cm ²
N° 1 (Ref)	10.433	10.435	10.438	10.437	10.438
N° 2 (Bias1)	10.395	10.398	10.398	10.398	10.391
N° 3 (Bias1)	10.429	10.428	10.427	10.426	10.418
N° 4 (Bias1)	10.342	10.341	10.343	10.343	10.345
N° 5 (Bias1)	10.344	10.341	10.343	10.345	10.343
N° 6 (Bias1)	10.391	10.385	10.387	10.387	10.378
N° 7 (Bias2)	10.321	10.320	10.319	10.318	10.311
N° 8 (Bias2)	10.395	10.395	10.394	10.391	10.378
N° 9 (Bias2)	10.424	10.422	10.423	10.421	10.411
N° 10 (Bias2)	10.249	10.244	10.242	10.238	10.231
N° 11 (Bias2)	10.400	10.394	10.394	10.392	10.380
N° 12 (OFF)	10.412	10.409	10.407	10.402	10.400
N° 13 (OFF)	10.458	10.450	10.451	10.455	10.447
N° 14 (OFF)	10.341	10.335	10.333	10.337	10.316
N° 15 (OFF)	10.337	10.333	10.332	10.333	10.325
N° 16 (OFF)	10.421	10.419	10.418	10.415	10.413

Delta [BVeco]

	0,p/cm ²	4E10.p/cm ²	2E11.p/cm ²	4E11.p/cm ²	1.91E12.p/cm ²
N° 1 (Ref)	---	2.180E-3	5.370E-3	4.020E-3	5.070E-3
N° 2 (Bias1)	---	3.300E-3	3.040E-3	3.400E-3	-4.270E-3
N° 3 (Bias1)	---	-8.400E-4	-1.070E-3	-2.760E-3	-1.028E-2
N° 4 (Bias1)	---	-7.800E-4	1.630E-3	1.010E-3	3.710E-3
N° 5 (Bias1)	---	-3.360E-3	-4.300E-4	6.100E-4	-8.900E-4
N° 6 (Bias1)	---	-5.460E-3	-3.740E-3	-4.110E-3	-1.321E-2
N° 7 (Bias2)	---	-3.300E-4	-1.580E-3	-2.640E-3	-9.800E-3
N° 8 (Bias2)	---	3.900E-4	-1.210E-3	-3.860E-3	-1.666E-2
N° 9 (Bias2)	---	-1.360E-3	-1.160E-3	-2.930E-3	-1.290E-2
N° 10 (Bias2)	---	-4.490E-3	-6.550E-3	-1.102E-2	-1.796E-2
N° 11 (Bias2)	---	-5.430E-3	-5.330E-3	-7.500E-3	-1.964E-2
N° 12 (OFF)	---	-2.230E-3	-4.920E-3	-9.090E-3	-1.191E-2
N° 13 (OFF)	---	-7.840E-3	-7.410E-3	-2.990E-3	-1.060E-2
N° 14 (OFF)	---	-6.480E-3	-7.800E-3	-4.650E-3	-2.562E-2
N° 15 (OFF)	---	-3.540E-3	-4.860E-3	-3.550E-3	-1.180E-2
N° 16 (OFF)	---	-1.770E-3	-2.970E-3	-5.600E-3	-7.630E-3
Average (Bias1)	---	-1.428E-3	-1.140E-4	-3.700E-4	-4.988E-3
σ (Bias1)	---	3.283E-3	2.605E-3	3.032E-3	6.866E-3
Average+3σ (Bias1)	---	8.421E-3	7.702E-3	8.727E-3	1.561E-2
Average-3σ (Bias1)	---	-1.128E-2	-7.930E-3	-9.467E-3	-2.559E-2
Average (Bias2)	---	-2.244E-3	-3.166E-3	-5.590E-3	-1.539E-2
σ (Bias2)	---	2.578E-3	2.574E-3	3.602E-3	3.992E-3
Average+3σ (Bias2)	---	5.489E-3	4.556E-3	5.217E-3	-3.417E-3
Average-3σ (Bias2)	---	-9.977E-3	-1.089E-2	-1.640E-2	-2.737E-2
Average (OFF)	---	-4.372E-3	-5.592E-3	-5.176E-3	-1.351E-2
σ (OFF)	---	2.670E-3	2.003E-3	2.408E-3	6.985E-3
Average+3σ (OFF)	---	3.639E-3	4.160E-4	2.049E-3	7.444E-3
Average-3σ (OFF)	---	-1.238E-2	-1.160E-2	-1.240E-2	-3.447E-2

190 MeV proton / detailed results

6. Ice(off)

Ta = 25°C ; Vce = 20V

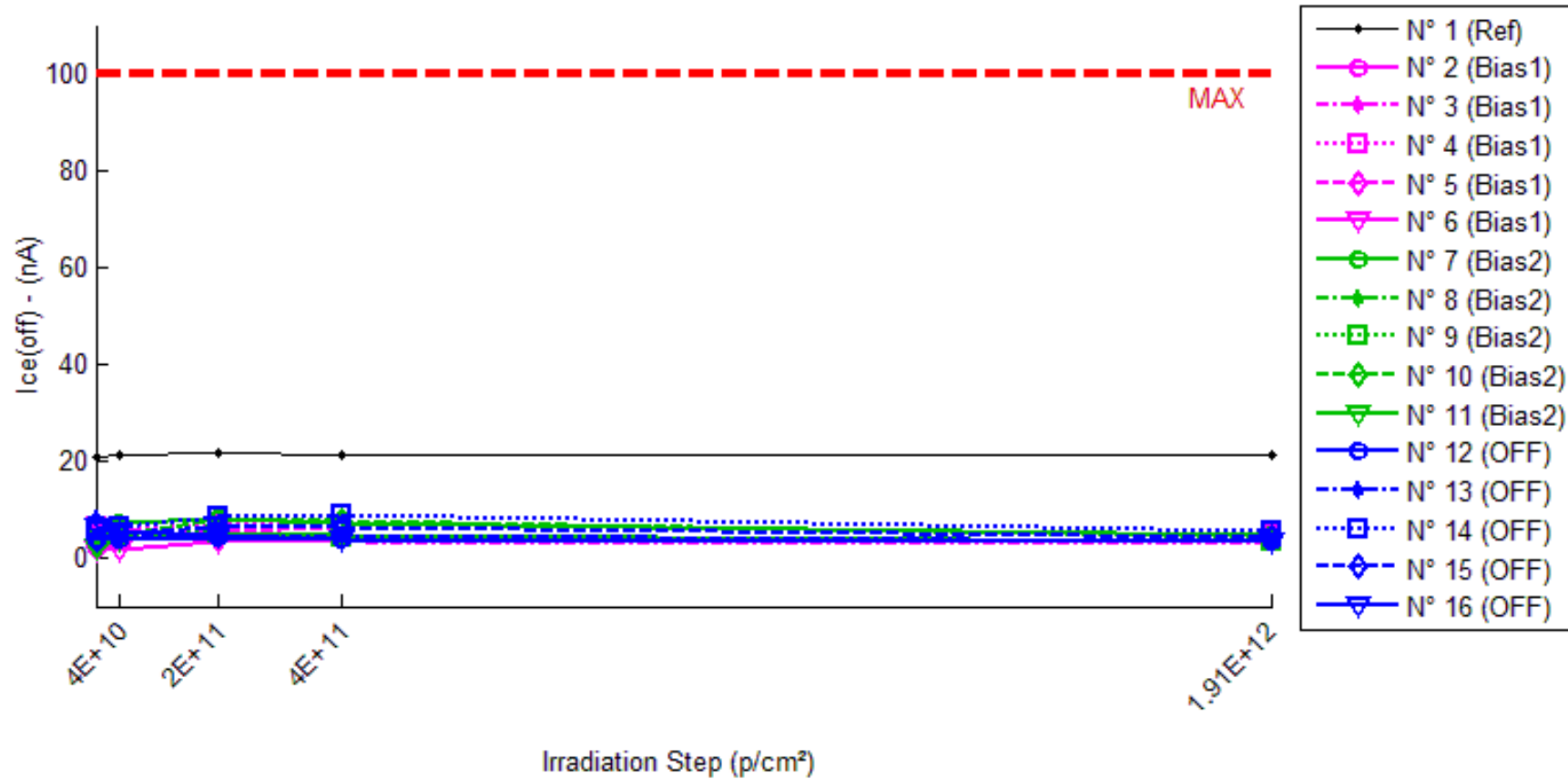

190 MeV proton / detailed results

Ice(off) . (nA)

Max = 100.0

	0.p/cm ²	4E10.p/cm ²	2E11.p/cm ²	4E11.p/cm ²	1.91E12.p/cm ²
N° 1 (Ref)	21.021	21.302	21.878	21.326	21.378
N° 2 (Bias1)	2.321	3.972	4.123	3.821	3.207
N° 3 (Bias1)	6.967	4.803	4.329	3.586	3.168
N° 4 (Bias1)	6.472	6.101	6.891	6.869	4.577
N° 5 (Bias1)	6.602	5.844	5.704	6.331	4.405
N° 6 (Bias1)	1.491	1.876	3.260	3.618	3.216
N° 7 (Bias2)	4.244	7.365	8.220	7.358	4.490
N° 8 (Bias2)	2.076	4.358	4.864	4.586	3.594
N° 9 (Bias2)	5.550	5.321	5.087	4.287	3.430
N° 10 (Bias2)	2.933	4.836	8.114	7.570	4.387
N° 11 (Bias2)	2.226	3.839	5.227	4.677	3.439
N° 12 (OFF)	3.800	3.951	4.245	3.814	3.388
N° 13 (OFF)	8.245	4.503	4.092	4.714	3.559
N° 14 (OFF)	5.467	6.275	8.481	9.085	5.576
N° 15 (OFF)	3.650	5.056	6.351	6.409	4.236
N° 16 (OFF)	6.222	5.547	4.471	4.029	3.613

Delta [Ice(off)]

	0.p/cm ²	4E10.p/cm ²	2E11.p/cm ²	4E11.p/cm ²	1.91E12.p/cm ²
N° 1 (Ref)	---	2.811E-1	8.574E-1	3.048E-1	3.567E-1
N° 2 (Bias1)	---	1.651E+0	1.802E+0	1.500E+0	8.856E-1
N° 3 (Bias1)	---	-2.164E+0	-2.638E+0	-3.381E+0	-3.799E+0
N° 4 (Bias1)	---	-3.716E-1	4.190E-1	3.966E-1	-1.895E+0
N° 5 (Bias1)	---	-7.578E-1	-8.986E-1	-2.709E-1	-2.197E+0
N° 6 (Bias1)	---	3.855E-1	1.769E+0	2.127E+0	1.725E+0
N° 7 (Bias2)	---	3.121E+0	3.976E+0	3.114E+0	2.460E-1
N° 8 (Bias2)	---	2.282E+0	2.788E+0	2.510E+0	1.518E+0
N° 9 (Bias2)	---	-2.293E-1	-4.630E-1	-1.264E+0	-2.120E+0
N° 10 (Bias2)	---	1.902E+0	5.181E+0	4.637E+0	1.454E+0
N° 11 (Bias2)	---	1.612E+0	3.001E+0	2.451E+0	1.213E+0
N° 12 (OFF)	---	1.506E-1	4.448E-1	1.351E-2	-4.119E-1
N° 13 (OFF)	---	-3.742E+0	-4.153E+0	-3.531E+0	-4.686E+0
N° 14 (OFF)	---	8.076E-1	3.013E+0	3.618E+0	1.089E-1
N° 15 (OFF)	---	1.406E+0	2.701E+0	2.759E+0	5.858E-1
N° 16 (OFF)	---	-6.748E-1	-1.751E+0	-2.193E+0	-2.609E+0
Average (Bias1)	---	-2.514E-1	9.085E-2	7.430E-2	-1.056E+0
σ (Bias1)	---	1.410E+0	1.889E+0	2.145E+0	2.293E+0
Average+3σ (Bias1)	---	3.979E+0	5.759E+0	6.510E+0	5.824E+0
Average-3σ (Bias1)	---	-4.482E+0	-5.577E+0	-6.362E+0	-7.936E+0
Average (Bias2)	---	1.738E+0	2.897E+0	2.290E+0	4.622E-1
σ (Bias2)	---	1.237E+0	2.103E+0	2.173E+0	1.531E+0
Average+3σ (Bias2)	---	5.449E+0	9.206E+0	8.809E+0	5.056E+0
Average-3σ (Bias2)	---	-1.974E+0	-3.413E+0	-4.230E+0	-4.132E+0
Average (OFF)	---	-4.104E-1	5.116E-2	1.334E-1	-1.403E+0
σ (OFF)	---	2.017E+0	3.036E+0	3.078E+0	2.205E+0
Average+3σ (OFF)	---	5.639E+0	9.159E+0	9.366E+0	5.214E+0
Average-3σ (OFF)	---	-6.460E+0	-9.057E+0	-9.099E+0	-8.019E+0

190 MeV proton / detailed results

7. VF

Ta = 25°C ; VF = 10mA

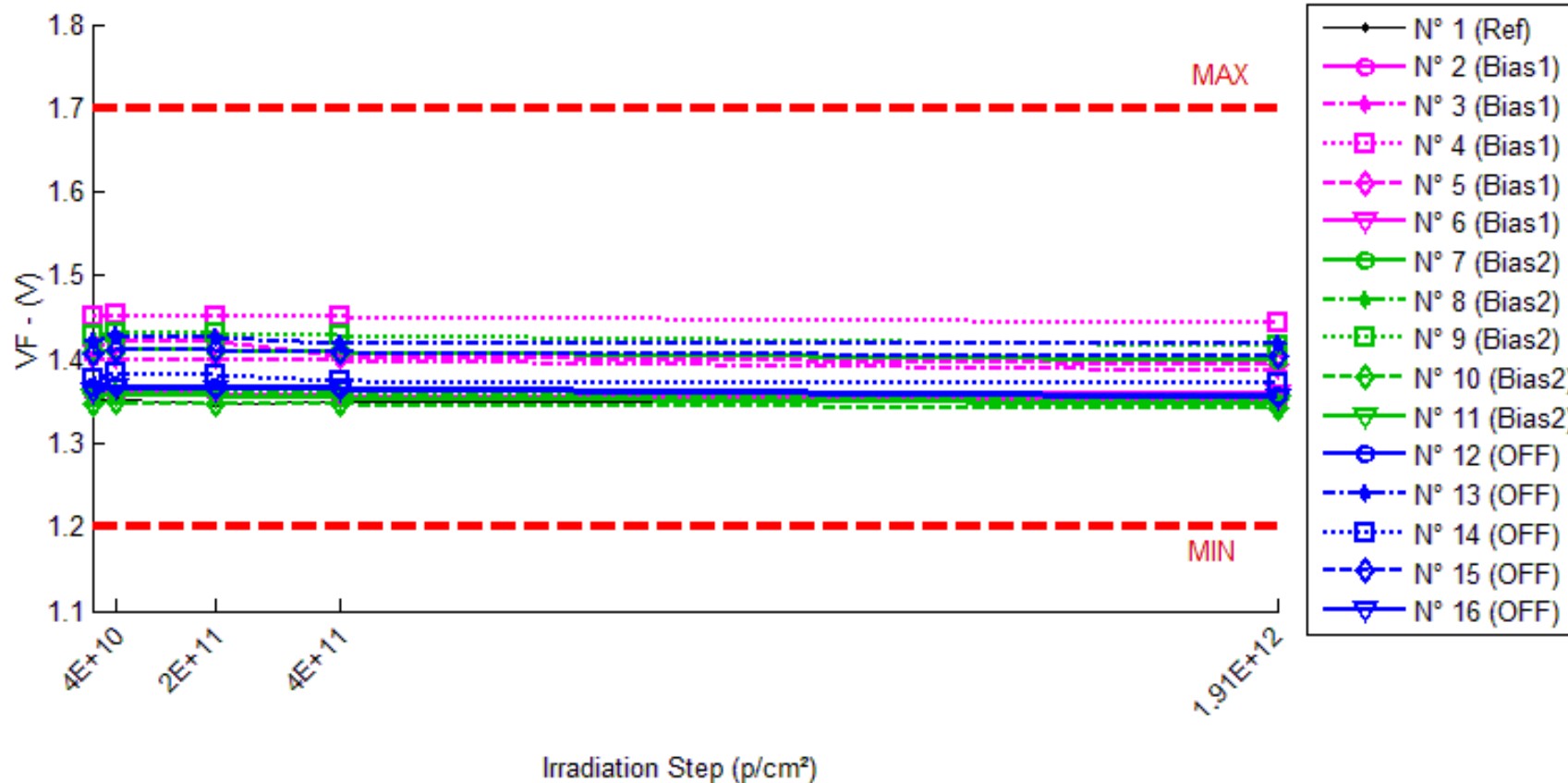

190 MeV proton / detailed results

VF . (V) Min = 1.2 Max = 1.7

	0,p/cm ²	4E10,p/cm ²	2E11,p/cm ²	4E11,p/cm ²	1.91E12,p/cm ²
N° 1 (Ref)	1.352	1.351	1.348	1.350	1.350
N° 2 (Bias1)	1.360	1.359	1.359	1.357	1.351
N° 3 (Bias1)	1.398	1.399	1.399	1.398	1.387
N° 4 (Bias1)	1.451	1.453	1.452	1.452	1.443
N° 5 (Bias1)	1.417	1.421	1.422	1.403	1.395
N° 6 (Bias1)	1.362	1.366	1.365	1.365	1.360
N° 7 (Bias2)	1.410	1.412	1.411	1.409	1.399
N° 8 (Bias2)	1.362	1.363	1.362	1.360	1.349
N° 9 (Bias2)	1.430	1.432	1.431	1.429	1.417
N° 10 (Bias2)	1.347	1.350	1.347	1.347	1.341
N° 11 (Bias2)	1.355	1.359	1.357	1.355	1.348
N° 12 (OFF)	1.368	1.369	1.368	1.368	1.357
N° 13 (OFF)	1.421	1.429	1.427	1.420	1.418
N° 14 (OFF)	1.376	1.383	1.382	1.375	1.371
N° 15 (OFF)	1.407	1.412	1.412	1.410	1.404
N° 16 (OFF)	1.363	1.366	1.365	1.364	1.354

Delta [VF]

	0,p/cm ²	4E10,p/cm ²	2E11,p/cm ²	4E11,p/cm ²	1.91E12,p/cm ²
N° 1 (Ref)	---	-1.577E-3	-3.726E-3	-2.623E-3	-2.632E-3
N° 2 (Bias1)	---	-1.367E-3	-1.190E-3	-2.849E-3	-8.702E-3
N° 3 (Bias1)	---	9.990E-4	6.080E-4	-4.780E-4	-1.106E-2
N° 4 (Bias1)	---	2.294E-3	1.372E-3	1.186E-3	-7.950E-3
N° 5 (Bias1)	---	4.124E-3	4.981E-3	-1.353E-2	-2.204E-2
N° 6 (Bias1)	---	3.861E-3	3.260E-3	2.619E-3	-1.857E-3
N° 7 (Bias2)	---	2.406E-3	1.212E-3	-1.282E-3	-1.107E-2
N° 8 (Bias2)	---	6.900E-4	-2.280E-4	-2.406E-3	-1.304E-2
N° 9 (Bias2)	---	2.464E-3	8.600E-4	-6.040E-4	-1.297E-2
N° 10 (Bias2)	---	2.903E-3	5.160E-4	8.000E-5	-5.631E-3
N° 11 (Bias2)	---	4.493E-3	2.394E-3	6.350E-4	-6.249E-3
N° 12 (OFF)	---	1.518E-3	7.790E-4	4.340E-4	-1.083E-2
N° 13 (OFF)	---	7.821E-3	6.206E-3	-4.570E-4	-2.586E-3
N° 14 (OFF)	---	7.592E-3	6.813E-3	-7.400E-5	-4.819E-3
N° 15 (OFF)	---	5.003E-3	4.918E-3	2.999E-3	-3.265E-3
N° 16 (OFF)	---	2.465E-3	1.650E-3	4.110E-4	-9.604E-3
Average (Bias1)	---	1.982E-3	1.806E-3	-2.611E-3	-1.032E-2
σ (Bias1)	---	2.258E-3	2.387E-3	6.435E-3	7.376E-3
Average+3σ (Bias1)	---	8.757E-3	8.968E-3	1.669E-2	1.181E-2
Average-3σ (Bias1)	---	-4.792E-3	-5.355E-3	-2.191E-2	-3.245E-2
Average (Bias2)	---	2.591E-3	9.508E-4	-7.154E-4	-9.792E-3
σ (Bias2)	---	1.358E-3	9.667E-4	1.188E-3	3.611E-3
Average+3σ (Bias2)	---	6.666E-3	3.851E-3	2.849E-3	1.041E-3
Average-3σ (Bias2)	---	-1.483E-3	-1.949E-3	-4.280E-3	-2.063E-2
Average (OFF)	---	4.880E-3	4.073E-3	6.626E-4	-6.221E-3
σ (OFF)	---	2.879E-3	2.715E-3	1.357E-3	3.762E-3
Average+3σ (OFF)	---	1.352E-2	1.222E-2	4.735E-3	5.065E-3
Average-3σ (OFF)	---	-3.757E-3	-4.073E-3	-3.410E-3	-1.751E-2

190 MeV proton / detailed results

8. Ir

Ta = 25°C ; Vr = 2V

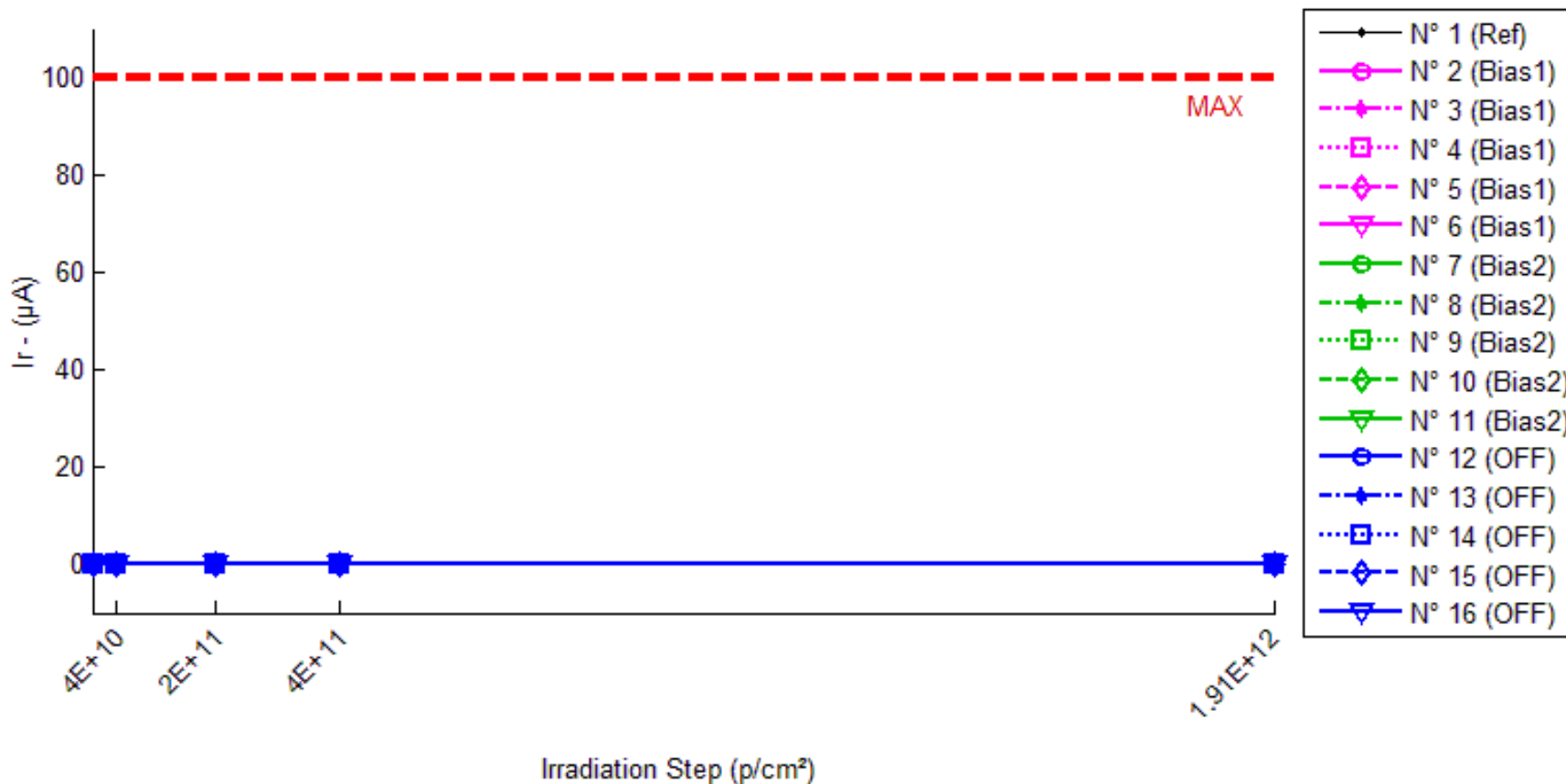

190 MeV proton / detailed results

Ir . (µA)

Max = 100.0

	0,p/cm ²	4E10,p/cm ²	2E11,p/cm ²	4E11,p/cm ²	1.91E12,p/cm ²
N° 1 (Ref)	5.815E-5	2.789E-5	2.102E-5	3.057E-5	4.453E-5
N° 2 (Bias1)	6.289E-5	4.428E-5	4.680E-5	5.518E-5	5.354E-5
N° 3 (Bias1)	4.260E-5	4.579E-5	4.671E-5	4.646E-5	5.358E-5
N° 4 (Bias1)	6.721E-5	4.336E-5	4.176E-5	4.612E-5	5.455E-5
N° 5 (Bias1)	5.253E-5	3.816E-5	4.294E-5	4.881E-5	5.995E-5
N° 6 (Bias1)	6.171E-5	5.426E-5	4.659E-5	3.996E-5	4.772E-5
N° 7 (Bias2)	6.037E-5	3.326E-5	7.940E-5	8.829E-5	1.136E-4
N° 8 (Bias2)	5.555E-5	8.070E-5	8.594E-5	9.009E-5	1.115E-4
N° 9 (Bias2)	6.130E-5	1.445E-4	1.285E-4	8.037E-5	1.083E-4
N° 10 (Bias2)	7.148E-5	2.282E-4	8.229E-5	8.380E-5	1.336E-4
N° 11 (Bias2)	9.755E-5	1.235E-4	1.103E-4	1.162E-4	1.365E-4
N° 12 (OFF)	5.212E-5	7.416E-5	7.571E-5	9.613E-5	8.669E-5
N° 13 (OFF)	5.635E-5	3.875E-5	6.871E-5	1.084E-4	9.893E-5
N° 14 (OFF)	5.451E-5	4.696E-5	7.261E-5	9.889E-5	9.457E-5
N° 15 (OFF)	6.674E-5	4.876E-5	7.798E-5	8.971E-5	9.822E-5
N° 16 (OFF)	5.572E-5	4.730E-5	7.362E-5	1.064E-4	9.156E-5

Delta [Ir]

	0,p/cm ²	4E10,p/cm ²	2E11,p/cm ²	4E11,p/cm ²	1.91E12,p/cm ²
N° 1 (Ref)	---	-3.026E-5	-3.713E-5	-2.758E-5	-1.362E-5
N° 2 (Bias1)	---	-1.861E-5	-1.609E-5	-7.712E-6	-9.346E-6
N° 3 (Bias1)	---	3.187E-6	4.109E-6	3.857E-6	1.098E-5
N° 4 (Bias1)	---	-2.385E-5	-2.544E-5	-2.108E-5	-1.266E-5
N° 5 (Bias1)	---	-1.437E-5	-9.596E-6	-3.729E-6	7.420E-6
N° 6 (Bias1)	---	-7.459E-6	-1.513E-5	-2.175E-5	-1.400E-5
N° 7 (Bias2)	---	-2.712E-5	1.903E-5	2.791E-5	5.319E-5
N° 8 (Bias2)	---	2.515E-5	3.039E-5	3.454E-5	5.595E-5
N° 9 (Bias2)	---	8.320E-5	6.723E-5	1.907E-5	4.698E-5
N° 10 (Bias2)	---	1.567E-4	1.081E-5	1.232E-5	6.211E-5
N° 11 (Bias2)	---	2.590E-5	1.274E-5	1.861E-5	3.894E-5
N° 12 (OFF)	---	2.205E-5	2.360E-5	4.401E-5	3.458E-5
N° 13 (OFF)	---	-1.760E-5	1.236E-5	5.210E-5	4.258E-5
N° 14 (OFF)	---	-7.544E-6	1.811E-5	4.438E-5	4.007E-5
N° 15 (OFF)	---	-1.798E-5	1.123E-5	2.297E-5	3.148E-5
N° 16 (OFF)	---	-8.424E-6	1.790E-5	5.071E-5	3.584E-5
Average (Bias1)	---	-1.222E-5	-1.243E-5	-1.008E-5	-3.520E-6
σ (Bias1)	---	1.050E-5	1.086E-5	1.115E-5	1.180E-5
Average+3σ (Bias1)	---	1.927E-5	2.014E-5	2.337E-5	3.189E-5
Average-3σ (Bias1)	---	-4.371E-5	-4.500E-5	-4.354E-5	-3.893E-5
Average (Bias2)	---	5.276E-5	2.804E-5	2.249E-5	5.143E-5
σ (Bias2)	---	6.998E-5	2.320E-5	8.727E-6	8.854E-6
Average+3σ (Bias2)	---	2.627E-4	9.764E-5	4.867E-5	7.800E-5
Average-3σ (Bias2)	---	-1.572E-4	-4.156E-5	-3.691E-6	2.487E-5
Average (OFF)	---	-5.901E-6	1.664E-5	4.283E-5	3.691E-5
σ (OFF)	---	1.638E-5	4.991E-6	1.169E-5	4.424E-6
Average+3σ (OFF)	---	4.323E-5	3.161E-5	7.790E-5	5.018E-5
Average-3σ (OFF)	---	-5.503E-5	1.666E-6	7.774E-6	2.364E-5

190 MeV proton / detailed results

9. TR

Ta = 25°C ; Vcc = 10V ; RL = 100 Ohms ; IF = 5mA

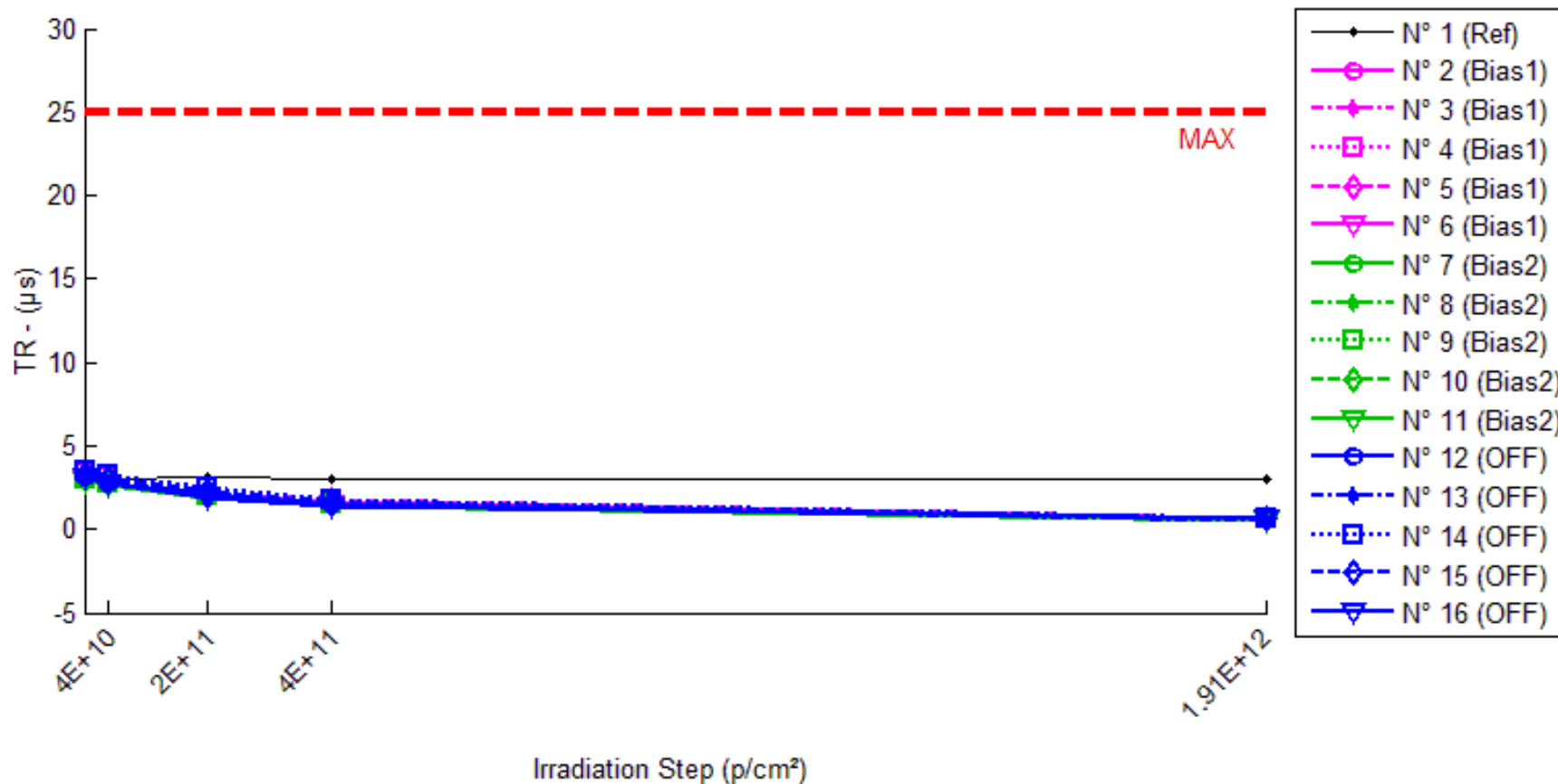

190 MeV proton / detailed results

TR . (µs)

Max = 25.0

	0,p/cm ²	4E10,p/cm ²	2E11,p/cm ²	4E11,p/cm ²	1.91E12,p/cm ²
N° 1 (Ref)	3.0	3.0	3.1	3.0	3.0
N° 2 (Bias1)	3.0	2.8	2.0	1.6	0.6
N° 3 (Bias1)	3.2	2.9	2.1	1.6	0.6
N° 4 (Bias1)	3.4	3.1	2.5	1.8	0.7
N° 5 (Bias1)	3.2	3.1	2.3	1.8	0.7
N° 6 (Bias1)	3.0	2.7	2.0	1.5	0.6
N° 7 (Bias2)	3.1	2.8	2.0	1.5	0.6
N° 8 (Bias2)	3.1	2.8	2.0	1.5	0.6
N° 9 (Bias2)	3.0	2.7	2.0	1.5	0.6
N° 10 (Bias2)	3.2	2.9	2.1	1.5	0.6
N° 11 (Bias2)	2.9	2.6	1.9	1.4	0.5
N° 12 (OFF)	3.1	2.8	2.1	1.5	0.6
N° 13 (OFF)	3.2	2.8	2.0	1.5	0.5
N° 14 (OFF)	3.5	3.2	2.5	1.8	0.7
N° 15 (OFF)	3.3	3.0	2.3	1.7	0.7
N° 16 (OFF)	3.1	2.7	1.9	1.4	0.6

Delta [TR]

	0,p/cm ²	4E10,p/cm ²	2E11,p/cm ²	4E11,p/cm ²	1.91E12,p/cm ²
N° 1 (Ref)	---	0.000E+0	1.000E-1	0.000E+0	0.000E+0
N° 2 (Bias1)	---	-2.000E-1	-1.000E+0	-1.400E+0	-2.400E+0
N° 3 (Bias1)	---	-3.000E-1	-1.100E+0	-1.600E+0	-2.600E+0
N° 4 (Bias1)	---	-3.000E-1	-9.000E-1	-1.600E+0	-2.700E+0
N° 5 (Bias1)	---	-1.000E-1	-9.000E-1	-1.400E+0	-2.500E+0
N° 6 (Bias1)	---	-3.000E-1	-1.000E+0	-1.500E+0	-2.400E+0
N° 7 (Bias2)	---	-3.000E-1	-1.100E+0	-1.600E+0	-2.500E+0
N° 8 (Bias2)	---	-3.000E-1	-1.100E+0	-1.600E+0	-2.500E+0
N° 9 (Bias2)	---	-3.000E-1	-1.000E+0	-1.500E+0	-2.400E+0
N° 10 (Bias2)	---	-3.000E-1	-1.100E+0	-1.700E+0	-2.600E+0
N° 11 (Bias2)	---	-3.000E-1	-1.000E+0	-1.500E+0	-2.400E+0
N° 12 (OFF)	---	-3.000E-1	-1.000E+0	-1.600E+0	-2.500E+0
N° 13 (OFF)	---	-4.000E-1	-1.200E+0	-1.700E+0	-2.700E+0
N° 14 (OFF)	---	-3.000E-1	-1.000E+0	-1.700E+0	-2.800E+0
N° 15 (OFF)	---	-3.000E-1	-1.000E+0	-1.600E+0	-2.600E+0
N° 16 (OFF)	---	-4.000E-1	-1.200E+0	-1.700E+0	-2.500E+0
Average (Bias1)	---	-2.400E-1	-9.800E-1	-1.500E+0	-2.520E+0
σ (Bias1)	---	8.944E-2	8.367E-2	1.000E-1	1.304E-1
Average+3σ (Bias1)	---	2.833E-2	-7.290E-1	-1.200E+0	-2.129E+0
Average-3σ (Bias1)	---	-5.083E-1	-1.231E+0	-1.800E+0	-2.911E+0
Average (Bias2)	---	-3.000E-1	-1.060E+0	-1.580E+0	-2.480E+0
σ (Bias2)	---	2.436E-16	5.477E-2	8.367E-2	8.367E-2
Average+3σ (Bias2)	---	-3.000E-1	-8.957E-1	-1.329E+0	-2.229E+0
Average-3σ (Bias2)	---	-3.000E-1	-1.224E+0	-1.831E+0	-2.731E+0
Average (OFF)	---	-3.400E-1	-1.080E+0	-1.660E+0	-2.620E+0
σ (OFF)	---	5.477E-2	1.095E-1	5.477E-2	1.304E-1
Average+3σ (OFF)	---	-1.757E-1	-7.514E-1	-1.496E+0	-2.229E+0
Average-3σ (OFF)	---	-5.043E-1	-1.409E+0	-1.824E+0	-3.011E+0

190 MeV proton / detailed results

10.TF

Ta = 25°C ; Vcc = 10V ; RL = 100 Ohms ; IF = 5mA

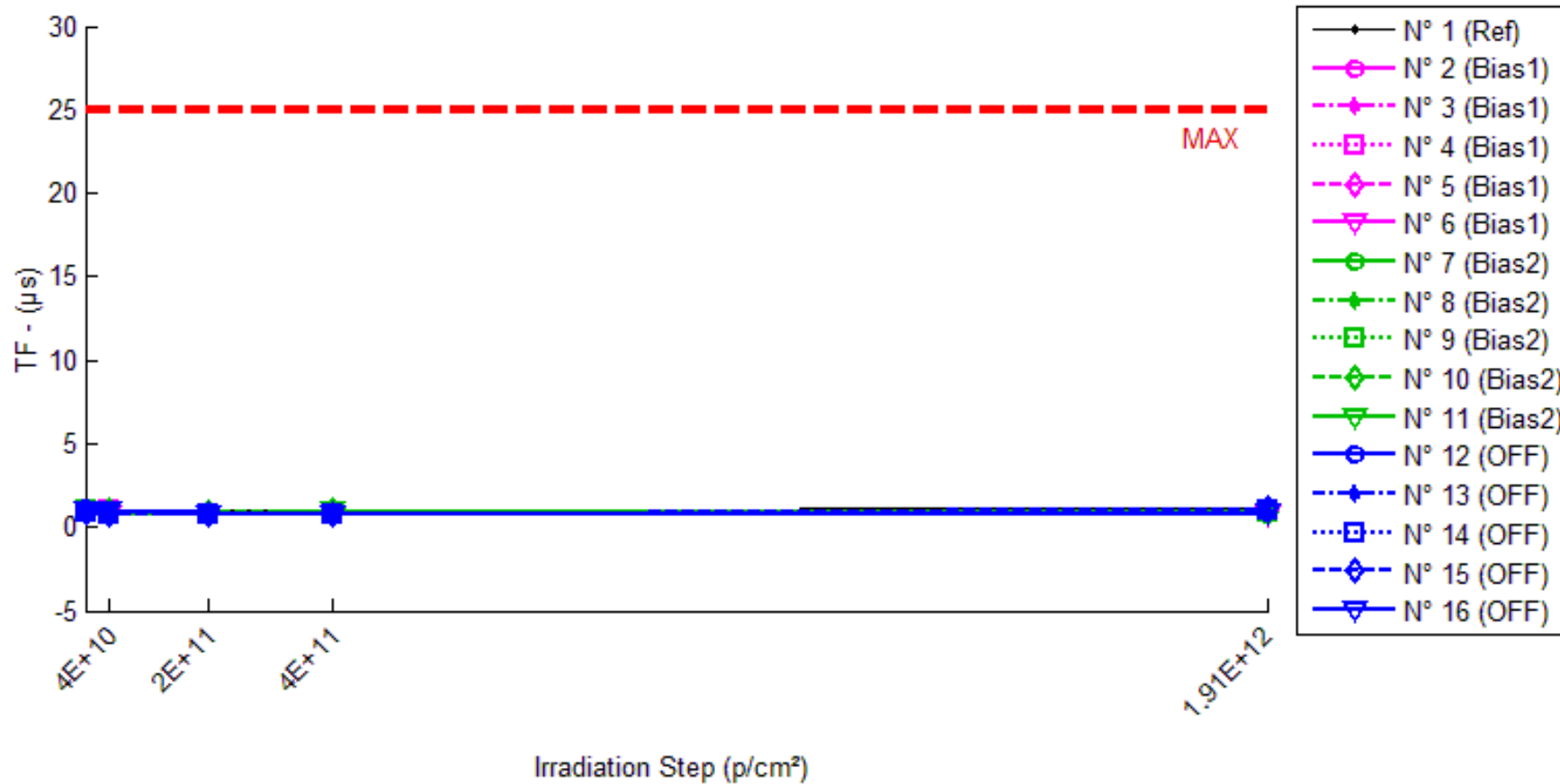

190 MeV proton / detailed results

TF . (μs) Max = 25.0

	0.p/cm ²	4E10.p/cm ²	2E11.p/cm ²	4E11.p/cm ²	1.91E12.p/cm ²
N° 1 (Ref)	1.0	1.0	1.0	1.0	1.1
N° 2 (Bias1)	1.0	1.0	0.8	0.8	0.9
N° 3 (Bias1)	1.1	0.9	0.8	0.8	0.8
N° 4 (Bias1)	1.0	1.0	0.8	0.8	1.0
N° 5 (Bias1)	0.9	0.8	0.8	0.8	1.0
N° 6 (Bias1)	1.0	0.8	0.8	0.8	0.8
N° 7 (Bias2)	1.0	0.9	0.8	1.0	0.8
N° 8 (Bias2)	1.0	0.9	0.9	0.8	1.0
N° 9 (Bias2)	1.0	0.9	0.8	0.8	0.9
N° 10 (Bias2)	0.9	1.0	0.9	1.0	0.9
N° 11 (Bias2)	1.0	1.0	0.8	1.0	0.9
N° 12 (OFF)	1.1	0.9	0.9	0.8	0.9
N° 13 (OFF)	1.1	0.9	0.9	0.8	0.9
N° 14 (OFF)	0.9	0.8	0.8	0.8	1.0
N° 15 (OFF)	0.9	0.8	0.8	0.8	1.1
N° 16 (OFF)	1.0	1.0	0.8	0.8	0.9

Delta [TF]

	0.p/cm ²	4E10.p/cm ²	2E11.p/cm ²	4E11.p/cm ²	1.91E12.p/cm ²
N° 1 (Ref)	---	0.000E+0	0.000E+0	0.000E+0	1.000E-1
N° 2 (Bias1)	---	0.000E+0	-2.000E-1	-2.000E-1	-1.000E-1
N° 3 (Bias1)	---	-2.000E-1	-3.000E-1	-3.000E-1	-3.000E-1
N° 4 (Bias1)	---	0.000E+0	-2.000E-1	-2.000E-1	0.000E+0
N° 5 (Bias1)	---	-1.000E-1	-1.000E-1	-1.000E-1	1.000E-1
N° 6 (Bias1)	---	-2.000E-1	-2.000E-1	-2.000E-1	-2.000E-1
N° 7 (Bias2)	---	-1.000E-1	-2.000E-1	0.000E+0	-2.000E-1
N° 8 (Bias2)	---	-1.000E-1	-1.000E-1	-2.000E-1	0.000E+0
N° 9 (Bias2)	---	-1.000E-1	-2.000E-1	-2.000E-1	-1.000E-1
N° 10 (Bias2)	---	1.000E-1	0.000E+0	1.000E-1	0.000E+0
N° 11 (Bias2)	---	0.000E+0	-2.000E-1	0.000E+0	-1.000E-1
N° 12 (OFF)	---	-2.000E-1	-2.000E-1	-3.000E-1	-2.000E-1
N° 13 (OFF)	---	-2.000E-1	-2.000E-1	-3.000E-1	-2.000E-1
N° 14 (OFF)	---	-1.000E-1	-1.000E-1	-1.000E-1	1.000E-1
N° 15 (OFF)	---	-1.000E-1	-1.000E-1	-1.000E-1	2.000E-1
N° 16 (OFF)	---	0.000E+0	-2.000E-1	-2.000E-1	-1.000E-1
Average (Bias1)	---	-1.000E-1	-2.000E-1	-2.000E-1	-1.000E-1
σ (Bias1)	---	1.000E-1	7.071E-2	7.071E-2	1.581E-1
Average+3σ (Bias1)	---	2.000E-1	1.213E-2	1.213E-2	3.743E-1
Average-3σ (Bias1)	---	-4.000E-1	-4.121E-1	-4.121E-1	-5.743E-1
Average (Bias2)	---	-4.000E-2	-1.400E-1	-6.000E-2	-8.000E-2
σ (Bias2)	---	8.944E-2	8.944E-2	1.342E-1	8.367E-2
Average+3σ (Bias2)	---	2.283E-1	1.283E-1	3.425E-1	1.710E-1
Average-3σ (Bias2)	---	-3.083E-1	-4.083E-1	-4.625E-1	-3.310E-1
Average (OFF)	---	-1.200E-1	-1.600E-1	-2.000E-1	-4.000E-2
σ (OFF)	---	8.367E-2	5.477E-2	1.000E-1	1.817E-1
Average+3σ (OFF)	---	1.310E-1	4.317E-3	1.000E-1	5.050E-1
Average-3σ (OFF)	---	-3.710E-1	-3.243E-1	-5.000E-1	-5.850E-1

190 MeV proton / detailed results

11.CTR2

Ta = 25°C ; IF = 2mA ; Vce = 5V

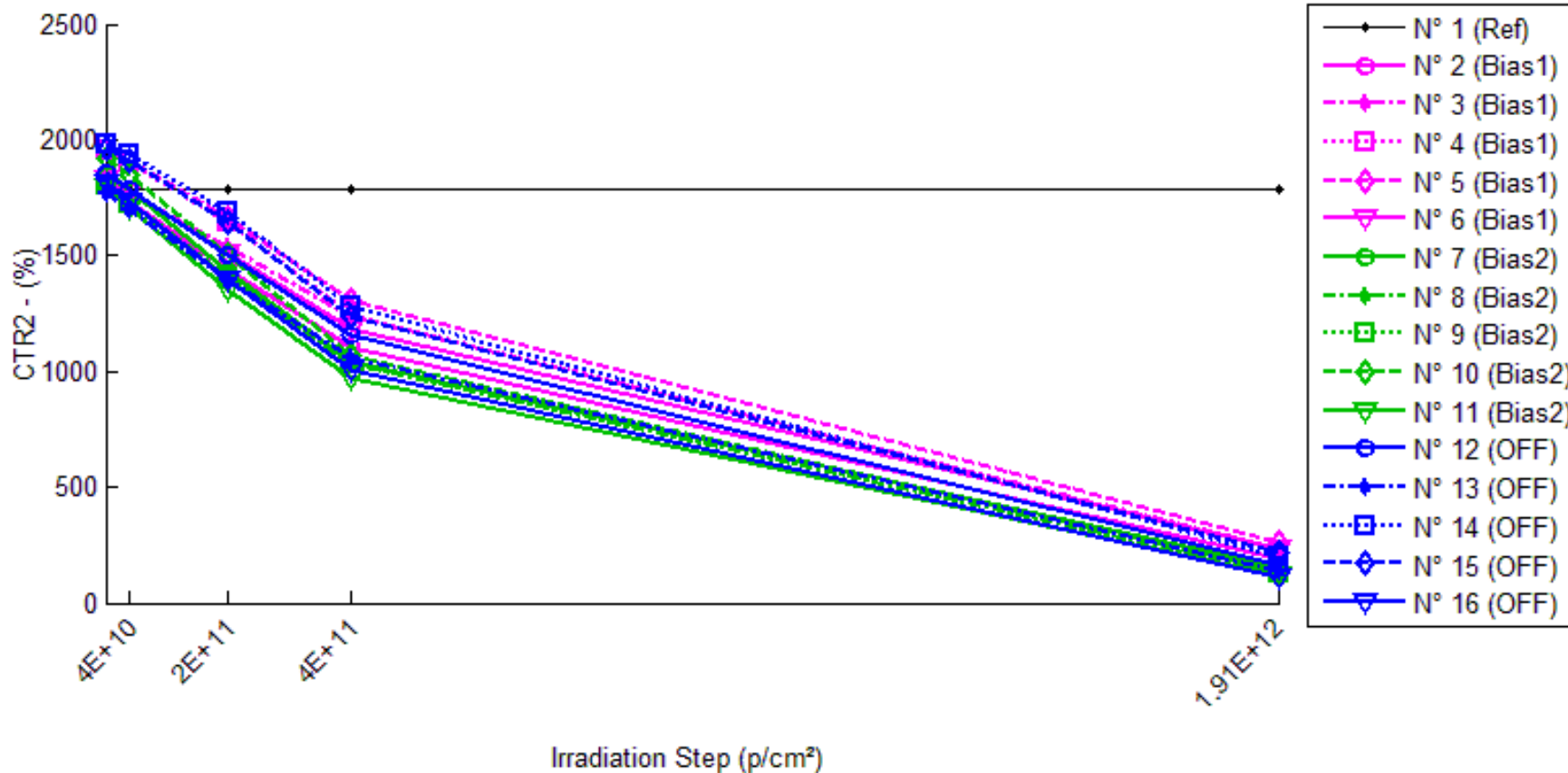

190 MeV proton / detailed results

CTR2 . (%)

	0.p/cm ²	4E10.p/cm ²	2E11.p/cm ²	4E11.p/cm ²	1.91E12.p/cm ²
N° 1 (Ref)	1790.41	1787.12	1784.55	1782.99	1782.69
N° 2 (Bias1)	1807.80	1733.10	1444.20	1102.84	186.50
N° 3 (Bias1)	1840.86	1767.26	1537.62	1240.60	231.62
N° 4 (Bias1)	1951.42	1897.23	1641.05	1243.15	223.87
N° 5 (Bias1)	1961.85	1910.50	1664.15	1303.64	258.01
N° 6 (Bias1)	1830.25	1774.01	1509.41	1182.43	235.46
N° 7 (Bias2)	1845.17	1782.24	1428.15	1044.65	159.37
N° 8 (Bias2)	1816.41	1733.29	1409.26	1036.25	129.11
N° 9 (Bias2)	1800.78	1722.96	1404.91	1031.82	126.79
N° 10 (Bias2)	1921.53	1851.61	1500.93	1072.17	139.66
N° 11 (Bias2)	1791.12	1707.99	1351.65	969.38	117.31
N° 12 (OFF)	1861.30	1783.38	1506.26	1157.75	161.24
N° 13 (OFF)	1771.32	1696.47	1394.43	1056.35	135.56
N° 14 (OFF)	1984.56	1936.41	1687.08	1280.69	200.53
N° 15 (OFF)	1965.30	1911.59	1641.22	1239.25	218.94
N° 16 (OFF)	1816.76	1734.43	1392.26	1003.10	114.98

1/Delta [CTR2]

	0.p/cm ²	4E10.p/cm ²	2E11.p/cm ²	4E11.p/cm ²	1.91E12.p/cm ²
N° 1 (Ref)	---	1.028E-6	1.833E-6	2.325E-6	2.418E-6
N° 2 (Bias1)	---	2.384E-5	1.393E-4	3.536E-4	4.809E-3
N° 3 (Bias1)	---	2.262E-5	1.071E-4	2.628E-4	3.774E-3
N° 4 (Bias1)	---	1.464E-5	9.692E-5	2.920E-4	3.955E-3
N° 5 (Bias1)	---	1.370E-5	9.118E-5	2.574E-4	3.366E-3
N° 6 (Bias1)	---	1.732E-5	1.161E-4	2.993E-4	3.701E-3
N° 7 (Bias2)	---	1.913E-5	1.583E-4	4.153E-4	5.733E-3
N° 8 (Bias2)	---	2.640E-5	1.591E-4	4.145E-4	7.195E-3
N° 9 (Bias2)	---	2.508E-5	1.565E-4	4.138E-4	7.332E-3
N° 10 (Bias2)	---	1.965E-5	1.458E-4	4.123E-4	6.640E-3
N° 11 (Bias2)	---	2.718E-5	1.815E-4	4.733E-4	7.966E-3
N° 12 (OFF)	---	2.347E-5	1.266E-4	3.265E-4	5.665E-3
N° 13 (OFF)	---	2.491E-5	1.526E-4	3.821E-4	6.812E-3
N° 14 (OFF)	---	1.253E-5	8.885E-5	2.769E-4	4.483E-3
N° 15 (OFF)	---	1.430E-5	1.005E-4	2.981E-4	4.059E-3
N° 16 (OFF)	---	2.613E-5	1.678E-4	4.465E-4	8.147E-3
Average (Bias1)	---	1.842E-5	1.101E-4	2.930E-4	3.921E-3
σ (Bias1)	---	4.605E-6	1.889E-5	3.838E-5	5.402E-4
Average+3 σ (Bias1)	---	3.224E-5	1.668E-4	4.082E-4	5.541E-3
Average-3 σ (Bias1)	---	4.609E-6	5.345E-5	1.779E-4	2.300E-3
Average (Bias2)	---	2.349E-5	1.602E-4	4.258E-4	6.973E-3
σ (Bias2)	---	3.818E-6	1.304E-5	2.654E-5	8.386E-4
Average+3 σ (Bias2)	---	3.494E-5	1.994E-4	5.055E-4	9.489E-3
Average-3 σ (Bias2)	---	1.203E-5	1.211E-4	3.462E-4	4.457E-3
Average (OFF)	---	2.027E-5	1.273E-4	3.460E-4	5.833E-3
σ (OFF)	---	6.359E-6	3.347E-5	6.863E-5	1.682E-3
Average+3 σ (OFF)	---	3.934E-5	2.277E-4	5.519E-4	1.088E-2
Average-3 σ (OFF)	---	1.191E-6	2.687E-5	1.401E-4	7.880E-4

190 MeV proton / detailed results

12.CTR3

Ta = 25°C ; IF = 10mA ; Vce = 5V

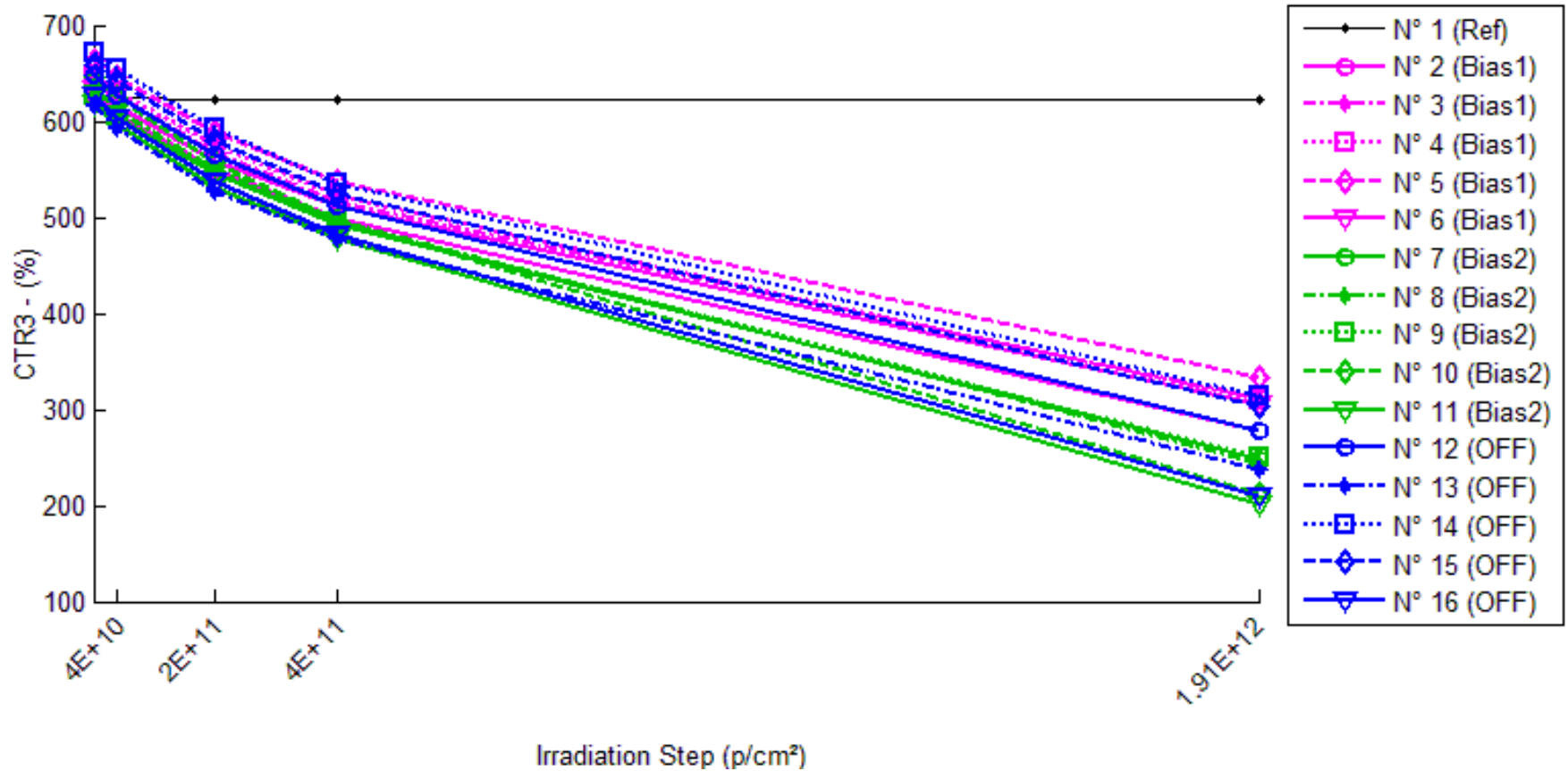

190 MeV proton / detailed results

CTR3 . (%)

	0.p/cm ²	4E10.p/cm ²	2E11.p/cm ²	4E11.p/cm ²	1.91E12.p/cm ²
N° 1 (Ref)	623.99	623.43	622.24	623.04	622.79
N° 2 (Bias1)	627.27	607.08	549.22	499.13	276.65
N° 3 (Bias1)	650.42	627.59	566.04	515.37	311.35
N° 4 (Bias1)	647.35	631.56	575.09	522.01	309.28
N° 5 (Bias1)	663.15	646.32	588.07	536.68	332.84
N° 6 (Bias1)	632.36	615.85	558.74	511.23	306.34
N° 7 (Bias2)	621.70	604.02	545.65	492.70	248.66
N° 8 (Bias2)	634.40	612.05	549.74	497.70	243.25
N° 9 (Bias2)	627.18	606.24	545.45	494.19	249.50
N° 10 (Bias2)	645.28	625.10	555.87	497.38	211.90
N° 11 (Bias2)	617.93	595.82	531.59	476.74	202.08
N° 12 (OFF)	647.93	626.69	564.55	512.03	277.10
N° 13 (OFF)	616.17	593.20	526.40	476.80	237.91
N° 14 (OFF)	671.72	653.80	592.45	535.20	313.08
N° 15 (OFF)	658.15	641.37	579.32	524.43	304.07
N° 16 (OFF)	626.11	603.24	536.87	482.16	210.39

1/Delta [CTR3]

	0.p/cm ²	4E10.p/cm ²	2E11.p/cm ²	4E11.p/cm ²	1.91E12.p/cm ²
N° 1 (Ref)	---	1.440E-6	4.507E-6	2.455E-6	3.097E-6
N° 2 (Bias1)	---	5.304E-5	2.265E-4	4.093E-4	2.020E-3
N° 3 (Bias1)	---	5.593E-5	2.292E-4	4.029E-4	1.674E-3
N° 4 (Bias1)	---	3.861E-5	1.941E-4	3.709E-4	1.689E-3
N° 5 (Bias1)	---	3.926E-5	1.925E-4	3.554E-4	1.496E-3
N° 6 (Bias1)	---	4.240E-5	2.084E-4	3.747E-4	1.683E-3
N° 7 (Bias2)	---	4.708E-5	2.242E-4	4.211E-4	2.413E-3
N° 8 (Bias2)	---	5.757E-5	2.428E-4	4.329E-4	2.535E-3
N° 9 (Bias2)	---	5.508E-5	2.389E-4	4.291E-4	2.414E-3
N° 10 (Bias2)	---	5.004E-5	2.493E-4	4.608E-4	3.170E-3
N° 11 (Bias2)	---	6.005E-5	2.628E-4	4.793E-4	3.330E-3
N° 12 (OFF)	---	5.230E-5	2.279E-4	4.096E-4	2.065E-3
N° 13 (OFF)	---	6.284E-5	2.768E-4	4.744E-4	2.580E-3
N° 14 (OFF)	---	4.082E-5	1.992E-4	3.797E-4	1.705E-3
N° 15 (OFF)	---	3.976E-5	2.068E-4	3.874E-4	1.769E-3
N° 16 (OFF)	---	6.054E-5	2.655E-4	4.768E-4	3.156E-3
Average (Bias1)	---	4.585E-5	2.101E-4	3.826E-4	1.713E-3
σ (Bias1)	---	8.077E-6	1.734E-5	2.273E-5	1.900E-4
Average+3 σ (Bias1)	---	7.008E-5	2.622E-4	4.508E-4	2.283E-3
Average-3 σ (Bias1)	---	2.162E-5	1.581E-4	3.144E-4	1.143E-3
Average (Bias2)	---	5.396E-5	2.436E-4	4.447E-4	2.772E-3
σ (Bias2)	---	5.341E-6	1.415E-5	2.446E-5	4.425E-4
Average+3 σ (Bias2)	---	6.999E-5	2.861E-4	5.180E-4	4.100E-3
Average-3 σ (Bias2)	---	3.794E-5	2.011E-4	3.713E-4	1.445E-3
Average (OFF)	---	5.125E-5	2.352E-4	4.256E-4	2.255E-3
σ (OFF)	---	1.076E-5	3.465E-5	4.695E-5	6.106E-4
Average+3 σ (OFF)	---	8.352E-5	3.392E-4	5.665E-4	4.087E-3
Average-3 σ (OFF)	---	1.898E-5	1.313E-4	2.847E-4	4.234E-4

190 MeV proton / detailed results

13.CTR4

Ta = 25°C ; IF = 40mA ; Vce = 5V

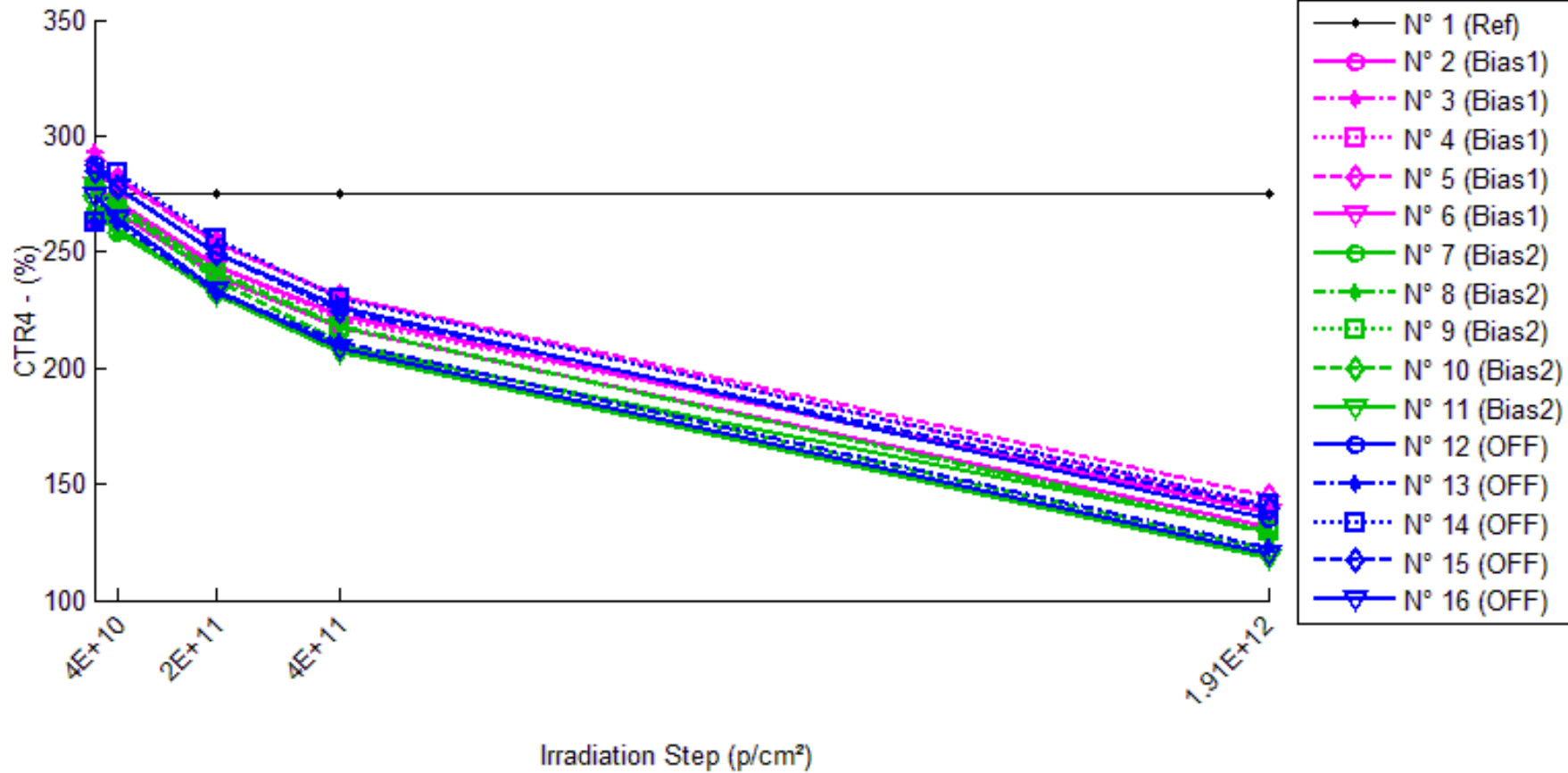

190 MeV proton / detailed results

CTR4 . (%)

	0,p/cm ²	4E10,p/cm ²	2E11,p/cm ²	4E11,p/cm ²	1.91E12,p/cm ²
N° 1 (Ref)	275.30	275.27	275.08	275.08	275.00
N° 2 (Bias1)	262.49	266.92	239.66	217.14	131.16
N° 3 (Bias1)	292.52	282.62	253.52	230.68	140.20
N° 4 (Bias1)	277.25	270.07	244.38	220.91	139.60
N° 5 (Bias1)	289.66	281.53	254.15	230.74	144.90
N° 6 (Bias1)	278.90	271.32	244.37	222.57	137.69
N° 7 (Bias2)	266.73	258.13	232.62	209.57	129.69
N° 8 (Bias2)	280.11	270.29	241.49	218.42	128.49
N° 9 (Bias2)	277.55	268.34	240.34	217.57	129.81
N° 10 (Bias2)	278.67	269.38	237.71	211.14	121.30
N° 11 (Bias2)	271.02	260.16	231.27	206.47	118.60
N° 12 (OFF)	287.59	278.19	249.40	225.99	134.75
N° 13 (OFF)	262.49	262.49	232.88	211.18	122.92
N° 14 (OFF)	262.49	284.07	255.55	229.84	141.06
N° 15 (OFF)	285.10	277.32	249.00	224.62	139.63
N° 16 (OFF)	274.60	264.40	233.65	208.95	119.71

1/Delta [CTR4]

	0,p/cm ²	4E10,p/cm ²	2E11,p/cm ²	4E11,p/cm ²	1.91E12,p/cm ²
N° 1 (Ref)	---	3.774E-7	2.814E-6	2.939E-6	3.877E-6
N° 2 (Bias1)	---	-6.319E-5	3.630E-4	7.956E-4	3.815E-3
N° 3 (Bias1)	---	1.198E-4	5.259E-4	9.165E-4	3.714E-3
N° 4 (Bias1)	---	9.593E-5	4.851E-4	9.200E-4	3.557E-3
N° 5 (Bias1)	---	9.964E-5	4.824E-4	8.816E-4	3.449E-3
N° 6 (Bias1)	---	1.001E-4	5.066E-4	9.073E-4	3.677E-3
N° 7 (Bias2)	---	1.248E-4	5.498E-4	1.023E-3	3.962E-3
N° 8 (Bias2)	---	1.298E-4	5.709E-4	1.008E-3	4.213E-3
N° 9 (Bias2)	---	1.236E-4	5.578E-4	9.934E-4	4.101E-3
N° 10 (Bias2)	---	1.236E-4	6.183E-4	1.148E-3	4.656E-3
N° 11 (Bias2)	---	1.539E-4	6.342E-4	1.154E-3	4.742E-3
N° 12 (OFF)	---	1.175E-4	5.325E-4	9.478E-4	3.944E-3
N° 13 (OFF)	---	1.350E-7	4.845E-4	9.256E-4	4.326E-3
N° 14 (OFF)	---	-2.894E-4	1.035E-4	5.412E-4	3.280E-3
N° 15 (OFF)	---	9.839E-5	5.084E-4	9.445E-4	3.654E-3
N° 16 (OFF)	---	1.405E-4	6.382E-4	1.144E-3	4.712E-3
Average (Bias1)	---	7.046E-5	4.726E-4	8.842E-4	3.642E-3
σ (Bias1)	---	7.529E-5	6.376E-5	5.175E-5	1.422E-4
Average+3σ (Bias1)	---	2.963E-4	6.639E-4	1.039E-3	4.069E-3
Average-3σ (Bias1)	---	-1.554E-4	2.813E-4	7.290E-4	3.216E-3
Average (Bias2)	---	1.312E-4	5.862E-4	1.065E-3	4.334E-3
σ (Bias2)	---	1.298E-5	3.776E-5	7.878E-5	3.455E-4
Average+3σ (Bias2)	---	1.701E-4	6.995E-4	1.301E-3	5.371E-3
Average-3σ (Bias2)	---	9.223E-5	4.729E-4	8.287E-4	3.298E-3
Average (OFF)	---	1.343E-5	4.534E-4	9.006E-4	3.983E-3
σ (OFF)	---	1.775E-4	2.042E-4	2.198E-4	5.597E-4
Average+3σ (OFF)	---	5.460E-4	1.066E-3	1.560E-3	5.662E-3
Average-3σ (OFF)	---	-5.192E-4	-1.592E-4	2.413E-4	2.304E-3

190 MeV proton / detailed results

14.CTR5

Ta = 25°C ; IF = 10mA ; Vce = 32V

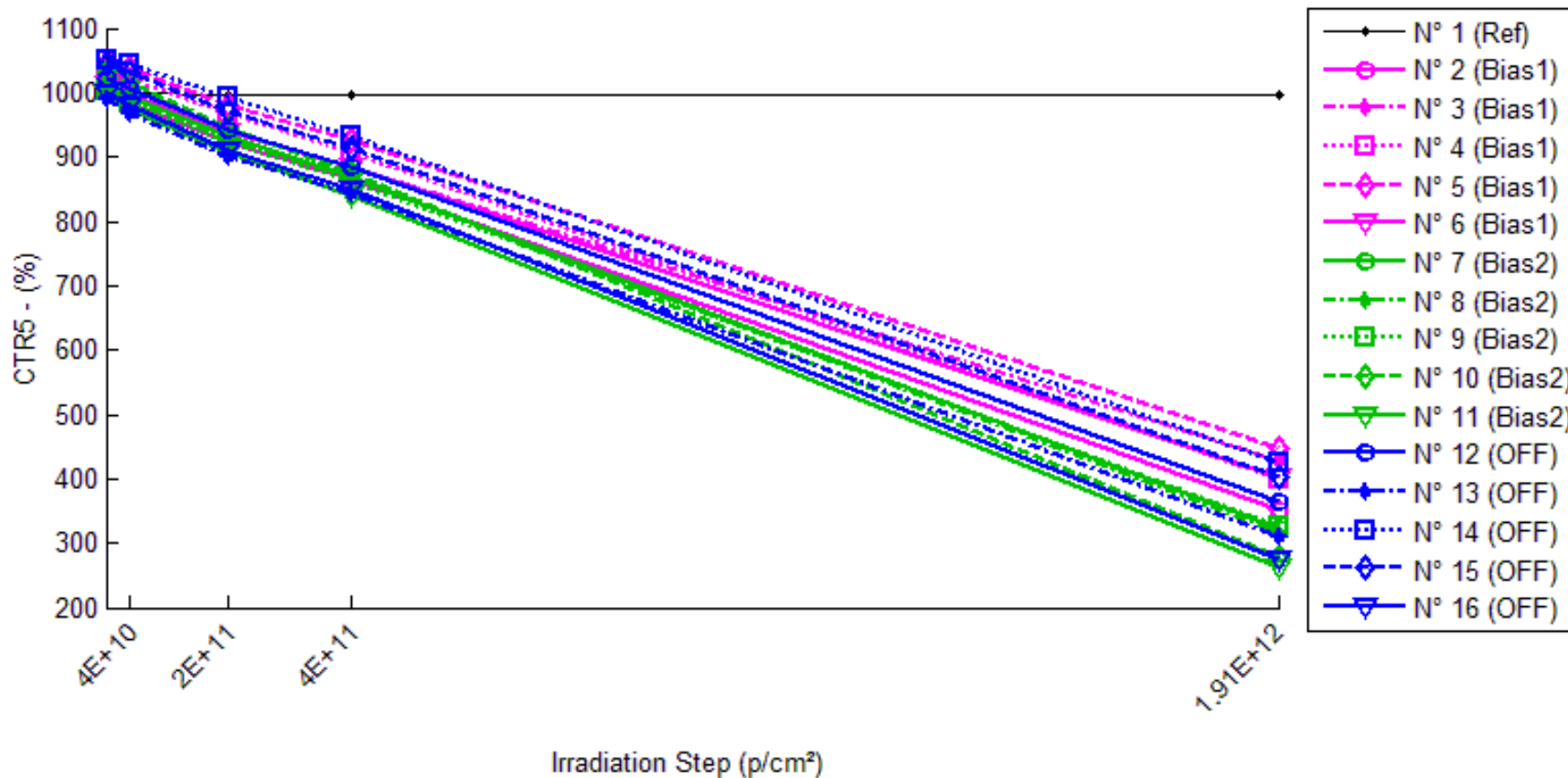

190 MeV proton / detailed results

CTR5 . (%)

	0.p/cm ²	4E10.p/cm ²	2E11.p/cm ²	4E11.p/cm ²	1.91E12.p/cm ²
N° 1 (Ref)	999.87	997.98	996.68	997.69	997.10
N° 2 (Bias1)	1005.69	984.34	924.43	866.91	350.47
N° 3 (Bias1)	1024.84	1002.13	938.14	883.12	427.04
N° 4 (Bias1)	1035.55	1022.65	966.59	906.76	399.75
N° 5 (Bias1)	1046.48	1036.92	981.06	924.63	448.23
N° 6 (Bias1)	1012.41	997.08	938.36	885.24	401.67
N° 7 (Bias2)	1009.16	992.52	933.58	868.82	323.77
N° 8 (Bias2)	1011.88	990.20	926.98	868.98	317.43
N° 9 (Bias2)	1004.25	984.04	921.53	863.67	325.50
N° 10 (Bias2)	1031.15	1014.11	944.46	874.43	278.10
N° 11 (Bias2)	994.78	974.95	907.45	841.41	263.73
N° 12 (OFF)	1023.29	1004.27	942.07	885.43	365.29
N° 13 (OFF)	990.44	969.04	899.23	842.05	309.96
N° 14 (OFF)	1049.90	1044.88	992.81	932.12	426.39
N° 15 (OFF)	1042.62	1031.78	972.21	911.80	404.01
N° 16 (OFF)	1001.05	979.38	911.40	847.99	274.99

1/Delta [CTR5]

	0.p/cm ²	4E10.p/cm ²	2E11.p/cm ²	4E11.p/cm ²	1.91E12.p/cm ²
N° 1 (Ref)	---	1.897E-6	3.207E-6	2.192E-6	2.783E-6
N° 2 (Bias1)	---	2.156E-5	8.741E-5	1.592E-4	1.859E-3
N° 3 (Bias1)	---	2.211E-5	9.018E-5	1.566E-4	1.366E-3
N° 4 (Bias1)	---	1.218E-5	6.889E-5	1.371E-4	1.536E-3
N° 5 (Bias1)	---	8.816E-6	6.372E-5	1.259E-4	1.275E-3
N° 6 (Bias1)	---	1.519E-5	7.795E-5	1.419E-4	1.502E-3
N° 7 (Bias2)	---	1.661E-5	8.022E-5	1.601E-4	2.098E-3
N° 8 (Bias2)	---	2.164E-5	9.051E-5	1.625E-4	2.162E-3
N° 9 (Bias2)	---	2.045E-5	8.938E-5	1.621E-4	2.076E-3
N° 10 (Bias2)	---	1.629E-5	8.901E-5	1.738E-4	2.626E-3
N° 11 (Bias2)	---	2.044E-5	9.674E-5	1.832E-4	2.786E-3
N° 12 (OFF)	---	1.850E-5	8.425E-5	1.521E-4	1.760E-3
N° 13 (OFF)	---	2.230E-5	1.024E-4	1.779E-4	2.217E-3
N° 14 (OFF)	---	4.580E-6	5.478E-5	1.203E-4	1.393E-3
N° 15 (OFF)	---	1.008E-5	6.946E-5	1.376E-4	1.516E-3
N° 16 (OFF)	---	2.211E-5	9.827E-5	1.803E-4	2.637E-3
Average (Bias1)	---	1.597E-5	7.763E-5	1.441E-4	1.508E-3
σ (Bias1)	---	5.813E-6	1.143E-5	1.384E-5	2.226E-4
Average+3σ (Bias1)	---	3.341E-5	1.119E-4	1.857E-4	2.175E-3
Average-3σ (Bias1)	---	-1.465E-6	4.333E-5	1.026E-4	8.397E-4
Average (Bias2)	---	1.909E-5	8.917E-5	1.683E-4	2.350E-3
σ (Bias2)	---	2.456E-6	5.900E-6	9.912E-6	3.319E-4
Average+3σ (Bias2)	---	2.646E-5	1.069E-4	1.981E-4	3.345E-3
Average-3σ (Bias2)	---	1.172E-5	7.147E-5	1.386E-4	1.354E-3
Average (OFF)	---	1.551E-5	8.183E-5	1.537E-4	1.905E-3
σ (OFF)	---	7.866E-6	1.990E-5	2.583E-5	5.168E-4
Average+3σ (OFF)	---	3.911E-5	1.415E-4	2.311E-4	3.455E-3
Average-3σ (OFF)	---	-8.085E-6	2.213E-5	7.619E-5	3.543E-4

190 MeV proton / detailed results

15.TRR

Ta = 25°C ; IF = 2mA ; RL = 100 Ohms ; Irec = 10% Irm

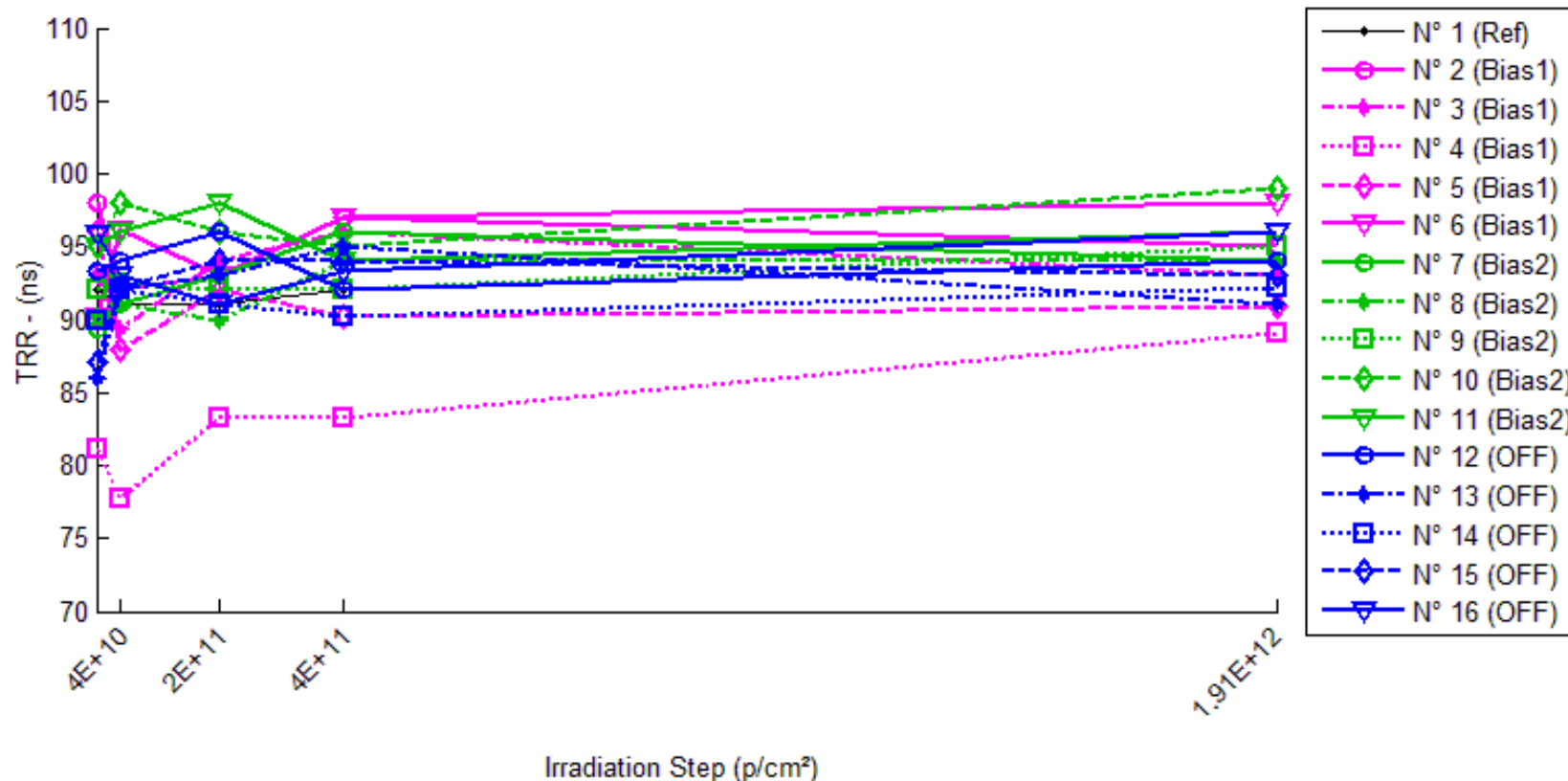

190 MeV proton / detailed results

TRR . (ns)

	0.p/cm ²	4E10.p/cm ²	2E11.p/cm ²	4E11.p/cm ²	1.91E12.p/cm ²
N° 1 (Ref)	92.0	91.1	91.1	92.0	94.0
N° 2 (Bias1)	98.0	92.0	93.1	97.0	95.0
N° 3 (Bias1)	93.1	89.3	94.0	96.0	93.1
N° 4 (Bias1)	81.2	77.7	83.2	83.2	89.1
N° 5 (Bias1)	96.0	88.0	92.0	90.2	90.9
N° 6 (Bias1)	90.2	96.1	93.1	97.0	98.0
N° 7 (Bias2)	89.3	91.1	93.1	96.0	94.0
N° 8 (Bias2)	90.2	91.1	90.0	94.0	94.0
N° 9 (Bias2)	92.0	92.5	92.0	92.0	95.0
N° 10 (Bias2)	95.0	98.0	96.0	95.0	99.0
N° 11 (Bias2)	95.0	96.0	98.0	94.0	96.0
N° 12 (OFF)	93.3	94.0	96.0	92.0	94.0
N° 13 (OFF)	86.0	92.0	93.1	95.0	91.1
N° 14 (OFF)	90.0	92.0	91.1	90.2	92.2
N° 15 (OFF)	87.1	92.2	94.0	94.0	93.1
N° 16 (OFF)	95.9	93.1	91.1	93.3	96.0

Delta [TRR]

	0.p/cm ²	4E10.p/cm ²	2E11.p/cm ²	4E11.p/cm ²	1.91E12.p/cm ²
N° 1 (Ref)	---	-9.109E-1	-9.109E-1	0.000E+0	2.000E+0
N° 2 (Bias1)	---	-6.000E+0	-4.931E+0	-9.703E-1	-2.951E+0
N° 3 (Bias1)	---	-3.813E+0	9.307E-1	2.931E+0	0.000E+0
N° 4 (Bias1)	---	-3.518E+0	1.980E+0	1.980E+0	7.921E+0
N° 5 (Bias1)	---	-8.000E+0	-4.000E+0	-5.804E+0	-5.091E+0
N° 6 (Bias1)	---	5.882E+0	2.873E+0	6.834E+0	7.804E+0
N° 7 (Bias2)	---	1.833E+0	3.813E+0	6.744E+0	4.744E+0
N° 8 (Bias2)	---	8.930E-1	-1.961E-1	3.804E+0	3.804E+0
N° 9 (Bias2)	---	5.000E-1	0.000E+0	0.000E+0	3.000E+0
N° 10 (Bias2)	---	2.951E+0	9.505E-1	0.000E+0	3.960E+0
N° 11 (Bias2)	---	1.000E+0	3.000E+0	-1.000E+0	1.000E+0
N° 12 (OFF)	---	6.667E-1	2.667E+0	-1.333E+0	6.667E-1
N° 13 (OFF)	---	6.000E+0	7.069E+0	9.000E+0	5.089E+0
N° 14 (OFF)	---	2.000E+0	1.089E+0	1.961E-1	2.157E+0
N° 15 (OFF)	---	5.028E+0	6.871E+0	6.871E+0	5.941E+0
N° 16 (OFF)	---	-2.798E+0	-4.779E+0	-2.534E+0	1.322E-1
Average (Bias1)	---	-3.090E+0	-6.293E-1	9.941E-1	1.537E+0
σ (Bias1)	---	5.334E+0	3.584E+0	4.714E+0	6.051E+0
Average+3σ (Bias1)	---	1.291E+1	1.012E+1	1.514E+1	1.969E+1
Average-3σ (Bias1)	---	-1.909E+1	-1.138E+1	-1.315E+1	-1.662E+1
Average (Bias2)	---	1.435E+0	1.514E+0	1.910E+0	3.302E+0
σ (Bias2)	---	9.762E-1	1.805E+0	3.268E+0	1.428E+0
Average+3σ (Bias2)	---	4.364E+0	6.928E+0	1.171E+1	7.585E+0
Average-3σ (Bias2)	---	-1.493E+0	-3.901E+0	-7.894E+0	-9.818E-1
Average (OFF)	---	2.179E+0	2.584E+0	2.440E+0	2.797E+0
σ (OFF)	---	3.529E+0	4.872E+0	5.164E+0	2.607E+0
Average+3σ (OFF)	---	1.277E+1	1.720E+1	1.793E+1	1.062E+1
Average-3σ (OFF)	---	-8.407E+0	-1.203E+1	-1.305E+1	-5.024E+0