

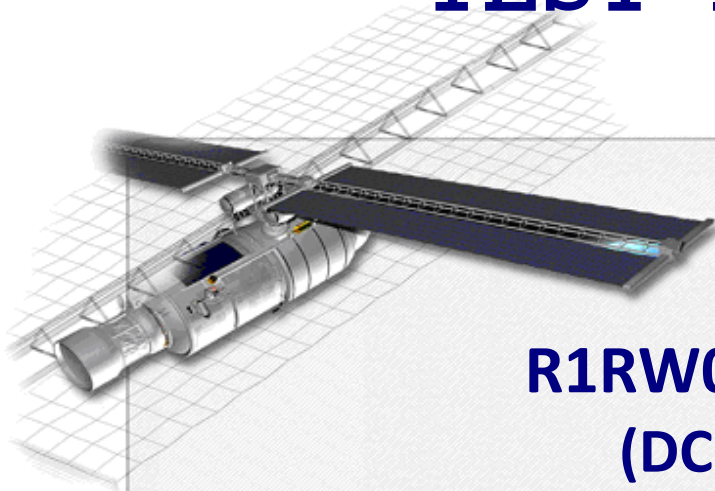

TOTAL IONIZING DOSE TEST REPORT



R1RW0416DSB (DC1346) 4M High Speed SRAM From Renesas

TRAD/TE/R1RW0416DSB/1346/ESA/LG/1409		Labège, 24 June 2015
 		TRAD, Bât Gallium 907, Voie l'Occitane - 31670 LABEGE France ☎ : 05 61 00 95 60 Fax: 05 61 00 95 61 Email: trad@trad.fr Web Site: www.trad.fr SIRET 397 862 038 00056 - TVA FR59397862038
Written by	Verified by / Quality control	Approved by
L. SALVY 15/07/2015	L. GOUYET 15/07/2015	P. GARCIA 15/07/2015
Revision: 0		
To: ESA Marc POIZAT	Project/Program: Ref:	

CONTENTS

1. Introduction.....	3
2. Documents	3
2.1. Applicable documents	3
2.2. Reference documents.....	3
3. Part information	3
3.1. Identification.....	3
3.2. Procurement information	3
3.3. Sample pictures.....	4
3.3.1. External view	4
3.3.2. Internal view	4
4. Dosimetry and irradiation facility.....	5
4.1. Irradiation facility.....	5
4.2. Irradiation time log	5
5. Bias setup	6
5.1. Parts distribution	6
5.2. Bias condition.....	6
5.3. Bias equipment identification	6
6. Test setup	7
6.1. Test parameters.....	7
6.2. Test equipment identification.....	7
7. Non conformance.....	7
8. Results	8
8.1. Presentation of the results	8
8.1.1. Technical comments.....	8
9. Conclusion	9
10. Appendix 1 measured parameters.....	10

FIGURES

Figure 1: Package marking.....	4
Figure 2: Internal overall view	4
Figure 3: Die marking	4
Figure 4: Bias Condition.....	6

1. INTRODUCTION

This report describes the testing and characterization of the **R1RW0416DSB** manufactured by **Renesas**. Irradiations began on 23 January 2015 and ended on 21 April 2015.

2. DOCUMENTS

2.1. Applicable documents

- Financial and technical proposal: TRAD/P/ESA/AO7751/AV/130214 Rev.0
- Irradiation test plan: ITP/TRA/TE/R1RW0416D/TSOPII-44/REN/120814 Issue 1

2.2. Reference documents

- Basic specification: ESCC N°22900 Issue 4 of October 2010
- Data-sheet: Renesas REJ03C0109-0201 Rev.2.01 of 16/06/2010

3. PART INFORMATION

3.1. Identification

Part designation	R1RW0416DSB
Manufacturer	Renesas
Part function	4M High Speed SRAM

3.2. Procurement information

Package	TSOP-44
Date code	1346
Number of tested parts	10 irradiated samples + 1 reference sample

3.3. Sample pictures

3.3.1. External view



Figure 1: Package marking

3.3.2. Internal view

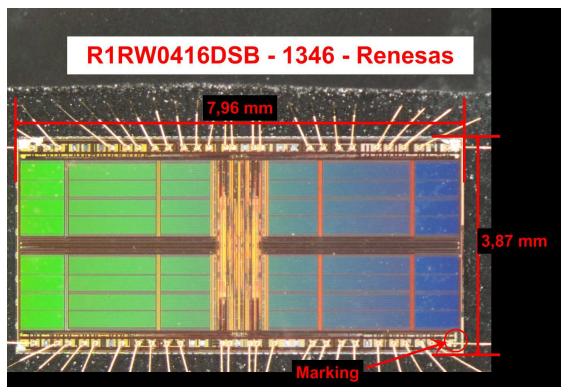

Figure 2: Internal overall view

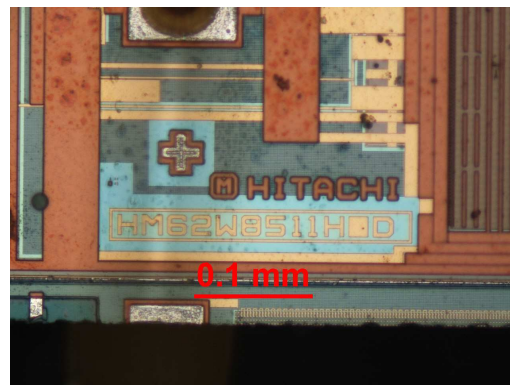

Figure 3: Die marking

4. DOSIMETRY AND IRRADIATION FACILITY

4.1. Irradiation facility

Irradiation source	⁶⁰ Co
Source location	U.C.L (Louvain-la-Neuve)
Irradiation equipment	GIF
Dosimetry equipment	PTW Ionization chamber

4.2. Irradiation time log

Total dose limit (krad(Si))	150				
Levels for measurements (krad(Si))	0	42	78	114	150
Dose rate (rad(Si)/h)	74				

5. BIAS SETUP

All irradiated components are biased under the following conditions. One component is not irradiated to act as a *REFERENCE*. All the parameters specified in the applicable ITP are measured on the *REFERENCE* and irradiated components.

5.1. Parts distribution

Serial number	Reference	Samples irradiated									
		2	3	4	5	6	7	8	9	10	11
TRAD mark	1										
Bias mode	REF	ON	ON	ON	ON	ON	OFF	OFF	OFF	OFF	OFF

5.2. Bias condition

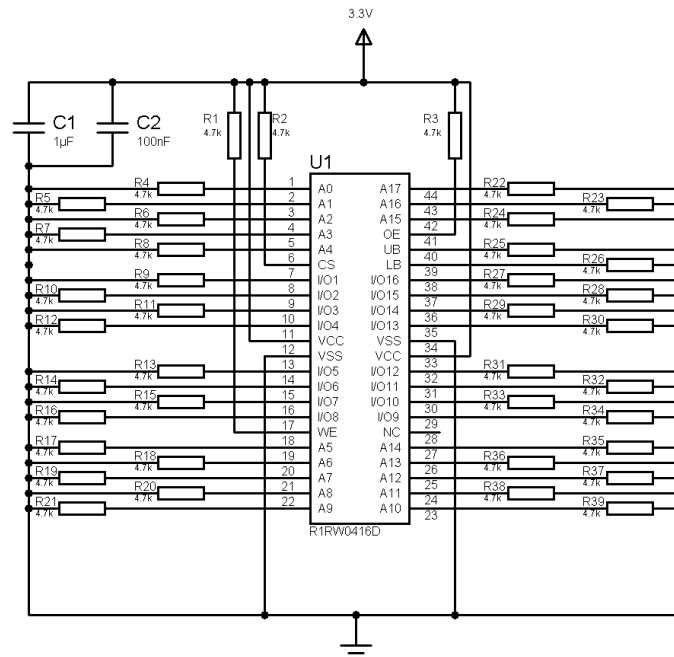

Figure 4: Bias Condition

5.3. Bias equipment identification

Bias board	TRAD/CP1/E/R1RW/ZIP48/CS/1407
Equipment	AR-69

6. TEST SETUP

6.1. Test parameters

Parameters	Symbols	Test conditions
Ta = 25°C, Vcc = 3.3V, Vih = 2.0V, Vil = 0.8V, unless otherwise specified.		
High Level Input leakage current	Ilih	Vin = Vcc
Low Level Input leakage current	Iilil	Vin = 0V
High Level Output leakage current	Iloh	Vout = Vcc
Low Level Output leakage current	Ilol	Vout = 0V
Operating power supply current	Icc_Read_20MHZ	CS# = Vil, read cycle = 20MHz
	Icc_Write_20MHZ	CS# = Vil, write cycle = 20MHz
Standby power supply current	Isb_H	CS# = Vih, Other inputs = Vih
	Isb_L	CS# = Vih, Other inputs = Vil
	Isb1_H	CS# = Vcc, Other inputs = Vcc
	Isb1_L	CS# = Vcc, Other inputs = 0V
Output voltage	Vol	Iol = 8mA
	Voh	Ioh = -4mA
Address access time	tAA	
Chip select access time	tACS	
Output enable to output valid	tOE	
Functional ZEROS	Func_0	Vcc = 3V, 3.3V and 3.6V, Functional test, write zeros, read zeros, full memory
Functional ONES	Func_1	Vcc = 3V, 3.3V and 3.6V, Functional test, write ones, read ones, full memory
Data Retention Voltage	Vdr	

6.2. Test equipment identification

Test board	TRAD/CT1/E/BTMS/ZIP48/LS/1408
Equipment	SM-91
Test program	R1RW0416D_TE_1346_MU_V10.mtx

7. NON CONFORMANCE

Test and measurement conditions were nominal.

8. RESULTS

8.1. Presentation of the results

For each parameter:

- The measurements performed at each irradiation step are registered in a table.
- Drifts between each measurement step and the "0" krad(Si) step are computed.

NB : * For the **CTR** and the **Hfe** parameters, the formula used is :

$$Drift = \frac{1}{measurement(Xkrad(Si))} - \frac{1}{measurement(0krad(Si))}$$

* For the **other measurements**, the formula used is:

$$Drift = measurement(Xkrad(Si)) - measurement(0krad(Si))$$

Where X stands for each measurement step.

8.1.1. Technical comments

No atypical behaviour during the test to report.

9. CONCLUSION

The total dose steady-state irradiation test using gamma rays from Cobalt 60 source has been carried out on **10 R1RW0416DSB**, a **4M High Speed SRAM** from **Renesas** up to **150 krad(Si)** at low dose rate (74 rad(Si)/h).

Hereunder our comments:

No failure observed on the DUTs at total dose level.

10. APPENDIX 1 MEASURED PARAMETERS

Contents :

1 Ilih_WE#	A-5
2 Ilih_A[0]	A-6
3 Ilih_A[1]	A-7
4 Ilih_A[2]	A-8
5 Ilih_A[3]	A-9
6 Ilih_A[4]	A-10
7 Ilih_A[5]	A-11
8 Ilih_A[6]	A-12
9 Ilih_A[7]	A-13
10 Ilih_A[8]	A-14
11 Ilih_A[9]	A-15
12 Ilih_A[10]	A-16
13 Ilih_A[11]	A-17
14 Ilih_A[12]	A-18
15 Ilih_A[13]	A-19
16 Ilih_A[14]	A-20
17 Ilih_A[15]	A-21
18 Ilih_A[16]	A-22
19 Ilih_A[17]	A-23
20 Ilih_CS#	A-24
21 Ilih_OE#	A-25
22 Ilih_UB#	A-26
23 Ilih_LB#	A-27
24 Ilii_WE#	A-28
25 Ilii_A[0]	A-29
26 Ilii_A[1]	A-30
27 Ilii_A[2]	A-31
28 Ilii_A[3]	A-32
29 Ilii_A[4]	A-33
30 Ilii_A[5]	A-34
31 Ilii_A[6]	A-35
32 Ilii_A[7]	A-36
33 Ilii_A[8]	A-37
34 Ilii_A[9]	A-38
35 Ilii_A[10]	A-39

Contents :

36	lil_A[11]	A-40
37	lil_A[12]	A-41
38	lil_A[13]	A-42
39	lil_A[14]	A-43
40	lil_A[15]	A-44
41	lil_A[16]	A-45
42	lil_A[17]	A-46
43	lil_CS#	A-47
44	lil_OE#	A-48
45	lil_UB#	A-49
46	lil_LB#	A-50
47	loh_IO[0]	A-51
48	loh_IO[1]	A-52
49	loh_IO[2]	A-53
50	loh_IO[3]	A-54
51	loh_IO[4]	A-55
52	loh_IO[5]	A-56
53	loh_IO[6]	A-57
54	loh_IO[7]	A-58
55	loh_IO[8]	A-59
56	loh_IO[9]	A-60
57	loh_IO[10]	A-61
58	loh_IO[11]	A-62
59	loh_IO[12]	A-63
60	loh_IO[13]	A-64
61	loh_IO[14]	A-65
62	loh_IO[15]	A-66
63	lol_IO[0]	A-67
64	lol_IO[1]	A-68
65	lol_IO[2]	A-69
66	lol_IO[3]	A-70
67	lol_IO[4]	A-71
68	lol_IO[5]	A-72
69	lol_IO[6]	A-73
70	lol_IO[7]	A-74

Contents :

71 IloI_IO[8]	A-75
72 IloI_IO[9]	A-76
73 IloI_IO[10]	A-77
74 IloI_IO[11]	A-78
75 IloI_IO[12]	A-79
76 IloI_IO[13]	A-80
77 IloI_IO[14]	A-81
78 IloI_IO[15]	A-82
79 Icc_Read_20MHz	A-83
80 Icc_Write_20MHz	A-84
81 Isb_H	A-85
82 Isb_L	A-86
83 Isb1_H	A-87
84 Isb1_L	A-88
85 Vol_IO[0]	A-89
86 Vol_IO[1]	A-90
87 Vol_IO[2]	A-91
88 Vol_IO[3]	A-92
89 Vol_IO[4]	A-93
90 Vol_IO[5]	A-94
91 Vol_IO[6]	A-95
92 Vol_IO[7]	A-96
93 Vol_IO[8]	A-97
94 Vol_IO[9]	A-98
95 Vol_IO[10]	A-99
96 Vol_IO[11]	A-100
97 Vol_IO[12]	A-101
98 Vol_IO[13]	A-102
99 Vol_IO[14]	A-103
100 Vol_IO[15]	A-104
101 Voh_IO[0]	A-105
102 Voh_IO[1]	A-106
103 Voh_IO[2]	A-107
104 Voh_IO[3]	A-108
105 Voh_IO[4]	A-109

Contents :

106 Voh_IO[5]	A-110
107 Voh_IO[6]	A-111
108 Voh_IO[7]	A-112
109 Voh_IO[8]	A-113
110 Voh_IO[9]	A-114
111 Voh_IO[10]	A-115
112 Voh_IO[11]	A-116
113 Voh_IO[12]	A-117
114 Voh_IO[13]	A-118
115 Voh_IO[14]	A-119
116 Voh_IO[15]	A-120
117 tAA	A-121
118 tACS	A-122
119 tOE	A-123
120 Func_0_Vcc_Min	A-124
121 Func_0_Vcc_Nom	A-125
122 Func_0_Vcc_Max	A-126
123 Func_1_Vcc_Min	A-127
124 Func_1_Vcc_Nom	A-128
125 Func_1_Vcc_Max	A-129
126 Vdr	A-130

1. Ilih_WE#

Ta = 25°C, Vcc = 3.3V, Vin = Vcc

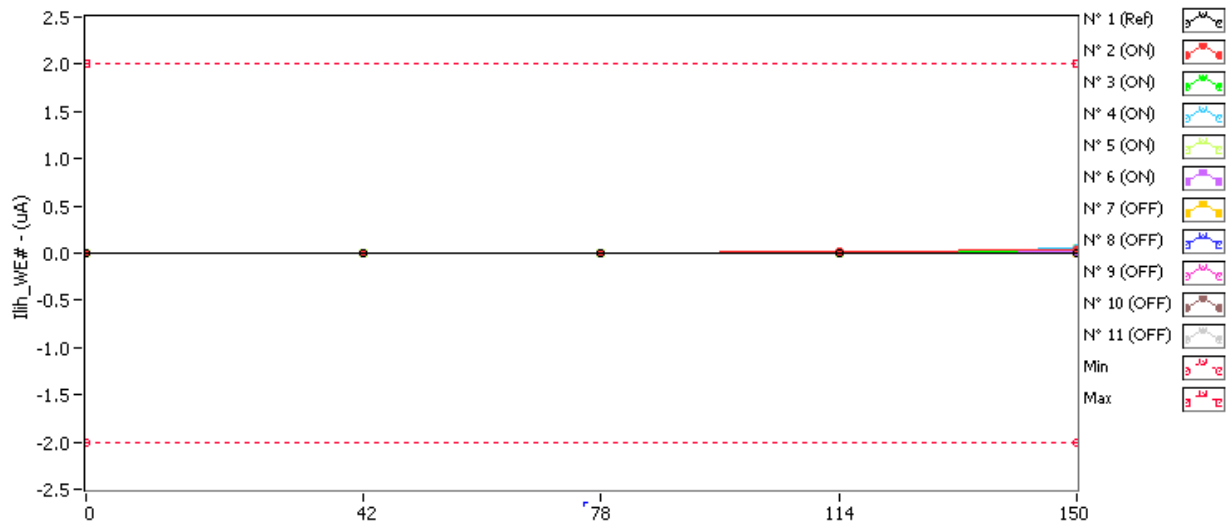

Ilih_WE# . (uA) Min = -2.0 Max = 2.0

	0krad(Si)	42krad(Si)	78krad(Si)	114krad(Si)	150krad(Si)
N° 1 (Ref)	3.145E-3	1.543E-3	2.230E-3	1.162E-3	1.772E-3
N° 2 (ON)	7.803E-4	9.329E-4	2.764E-3	9.707E-3	3.885E-2
N° 3 (ON)	2.001E-3	2.077E-3	1.772E-3	4.748E-3	3.778E-2
N° 4 (ON)	1.925E-3	2.535E-3	3.069E-3	4.595E-3	4.877E-2
N° 5 (ON)	1.162E-3	2.535E-3	1.696E-3	3.374E-3	5.892E-2
N° 6 (ON)	1.162E-3	1.772E-3	2.535E-3	8.791E-3	1.757E-2
N° 7 (OFF)	1.391E-3	1.467E-3	2.535E-3	1.543E-3	2.688E-3
N° 8 (OFF)	1.696E-3	8.566E-4	1.162E-3	2.535E-3	2.688E-3
N° 9 (OFF)	1.543E-3	2.077E-3	1.925E-3	2.611E-3	2.382E-3
N° 10 (OFF)	2.154E-3	2.230E-3	1.162E-3	1.467E-3	1.238E-3
N° 11 (OFF)	2.154E-3	2.230E-3	1.772E-3	2.993E-3	2.611E-3

Delta [Ilih_WE#]

	0krad(Si)	42krad(Si)	78krad(Si)	114krad(Si)	150krad(Si)
N° 1 (Ref)	---	-1.602E-3	-9.155E-4	-1.984E-3	-1.373E-3
N° 2 (ON)	---	1.526E-4	1.984E-3	8.926E-3	3.807E-2
N° 3 (ON)	---	7.630E-5	-2.289E-4	2.747E-3	3.578E-2
N° 4 (ON)	---	6.103E-4	1.144E-3	2.670E-3	4.684E-2
N° 5 (ON)	---	1.373E-3	5.341E-4	2.213E-3	5.775E-2
N° 6 (ON)	---	6.104E-4	1.373E-3	7.629E-3	1.640E-2
N° 7 (OFF)	---	7.630E-5	1.144E-3	1.526E-4	1.297E-3
N° 8 (OFF)	---	-8.392E-4	-5.341E-4	8.392E-4	9.918E-4
N° 9 (OFF)	---	5.341E-4	3.815E-4	1.068E-3	8.392E-4
N° 10 (OFF)	---	7.630E-5	-9.919E-4	-6.867E-4	-9.156E-4
N° 11 (OFF)	---	7.630E-5	-3.815E-4	8.392E-4	4.577E-4
Average (ON)	---	5.646E-4	9.613E-4	4.837E-3	3.897E-2
s (ON)	---	5.163E-4	8.437E-4	3.181E-3	1.529E-2
Average+3s (ON)	---	2.114E-3	3.492E-3	1.438E-2	8.484E-2
Average-3s (ON)	---	-9.844E-4	-1.570E-3	-4.706E-3	-6.898E-3
Average (OFF)	---	-1.525E-5	-7.632E-5	4.425E-4	5.340E-4
s (OFF)	---	5.015E-4	8.427E-4	7.185E-4	8.649E-4
Average+3s (OFF)	---	1.489E-3	2.452E-3	2.598E-3	3.129E-3
Average-3s (OFF)	---	-1.520E-3	-2.604E-3	-1.713E-3	-2.061E-3

2. Ilih_A[0]

Ta = 25°C, Vcc = 3.3V, Vin = Vcc

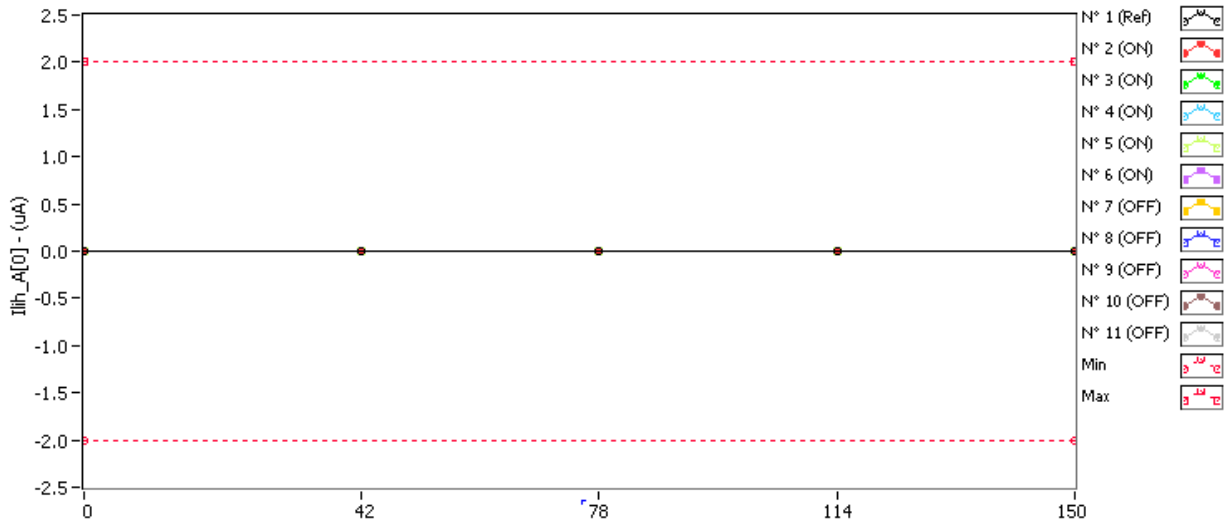

Ilih_A[0] . (uA) **Min = -2.0 Max = 2.0**

	0krad(Si)	42krad(Si)	78krad(Si)	114krad(Si)	150krad(Si)
N° 1 (Ref)	2.306E-3	1.696E-3	2.993E-3	1.543E-3	2.764E-3
N° 2 (ON)	2.993E-3	2.916E-3	2.840E-3	3.451E-3	3.451E-3
N° 3 (ON)	2.001E-3	1.620E-3	1.696E-3	2.077E-3	1.391E-3
N° 4 (ON)	2.077E-3	1.543E-3	2.382E-3	3.374E-3	3.145E-3
N° 5 (ON)	3.222E-3	2.916E-3	3.145E-3	3.222E-3	2.764E-3
N° 6 (ON)	3.222E-3	3.145E-3	2.077E-3	4.290E-3	2.230E-3
N° 7 (OFF)	2.077E-3	1.467E-3	2.382E-3	2.916E-3	1.772E-3
N° 8 (OFF)	1.467E-3	3.069E-3	3.145E-3	1.848E-3	2.611E-3
N° 9 (OFF)	3.222E-3	2.459E-3	2.993E-3	3.222E-3	2.230E-3
N° 10 (OFF)	2.993E-3	1.848E-3	1.696E-3	1.467E-3	2.382E-3
N° 11 (OFF)	1.772E-3	1.925E-3	3.832E-3	3.145E-3	1.696E-3

Delta [Ilih_A[0]]

	0krad(Si)	42krad(Si)	78krad(Si)	114krad(Si)	150krad(Si)
N° 1 (Ref)	---	-6.104E-4	6.866E-4	-7.630E-4	4.577E-4
N° 2 (ON)	---	-7.630E-5	-1.526E-4	4.578E-4	4.578E-4
N° 3 (ON)	---	-3.815E-4	-3.052E-4	7.630E-5	-6.104E-4
N° 4 (ON)	---	-5.341E-4	3.051E-4	1.297E-3	1.068E-3
N° 5 (ON)	---	-3.052E-4	-7.630E-5	0.000E+0	-4.578E-4
N° 6 (ON)	---	-7.630E-5	-1.144E-3	1.068E-3	-9.918E-4
N° 7 (OFF)	---	-6.104E-4	3.051E-4	8.392E-4	-3.052E-4
N° 8 (OFF)	---	1.602E-3	1.679E-3	3.815E-4	1.144E-3
N° 9 (OFF)	---	-7.630E-4	-2.289E-4	0.000E+0	-9.918E-4
N° 10 (OFF)	---	-1.144E-3	-1.297E-3	-1.526E-3	-6.104E-4
N° 11 (OFF)	---	1.526E-4	2.060E-3	1.373E-3	-7.630E-5
Average (ON)	---	-2.747E-4	-2.747E-4	5.798E-4	-1.068E-4
s (ON)	---	1.990E-4	5.357E-4	5.825E-4	8.455E-4
Average+3s (ON)	---	3.222E-4	1.332E-3	2.327E-3	2.430E-3
Average-3s (ON)	---	-8.716E-4	-1.882E-3	-1.168E-3	-2.643E-3
Average (OFF)	---	-1.526E-4	5.035E-4	2.136E-4	-1.679E-4
s (OFF)	---	1.088E-3	1.380E-3	1.100E-3	8.099E-4
Average+3s (OFF)	---	3.113E-3	4.644E-3	3.512E-3	2.262E-3
Average-3s (OFF)	---	-3.418E-3	-3.637E-3	-3.085E-3	-2.598E-3

3. Ilih_A[1]

Ta = 25°C, Vcc = 3.3V, Vin = Vcc

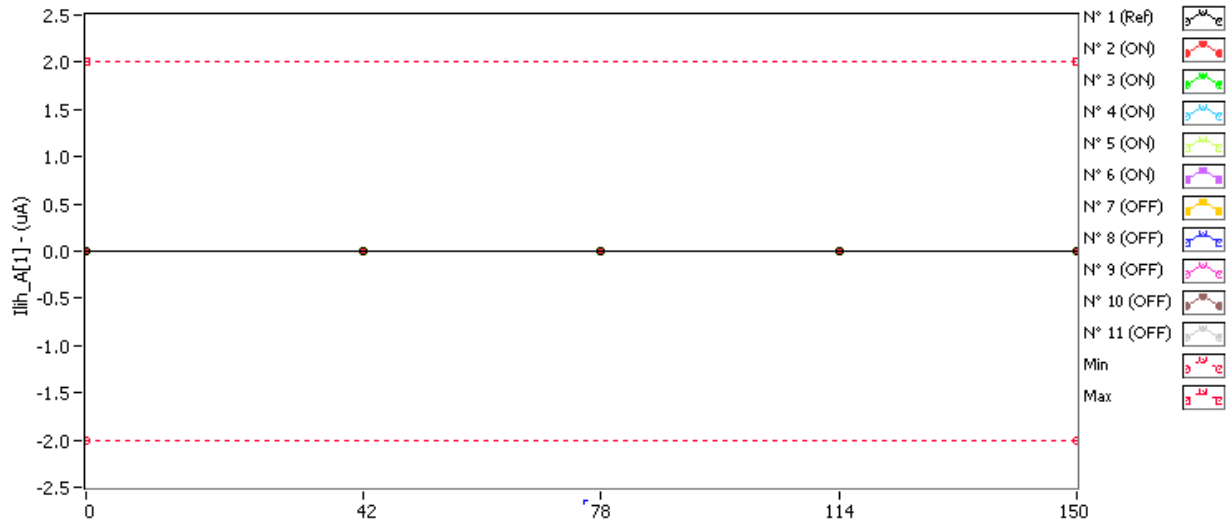

Ilih_A[1] . (uA) Min = -2.0 Max = 2.0

	0krad(Si)	42krad(Si)	78krad(Si)	114krad(Si)	150krad(Si)
N° 1 (Ref)	2.840E-3	2.382E-3	1.238E-3	2.535E-3	2.306E-3
N° 2 (ON)	2.916E-3	2.688E-3	2.001E-3	1.238E-3	1.391E-3
N° 3 (ON)	1.162E-3	1.848E-3	2.230E-3	1.696E-3	1.009E-3
N° 4 (ON)	2.230E-3	2.001E-3	7.803E-4	1.085E-3	7.803E-4
N° 5 (ON)	2.382E-3	2.459E-3	2.764E-3	2.154E-3	9.329E-4
N° 6 (ON)	1.620E-3	3.225E-4	2.688E-3	2.230E-3	6.277E-4
N° 7 (OFF)	2.535E-3	2.001E-3	2.077E-3	2.535E-3	3.145E-3
N° 8 (OFF)	2.230E-3	2.611E-3	9.329E-4	1.085E-3	8.566E-4
N° 9 (OFF)	1.772E-3	1.314E-3	1.620E-3	1.391E-3	2.230E-3
N° 10 (OFF)	2.993E-3	1.085E-3	2.001E-3	2.230E-3	1.925E-3
N° 11 (OFF)	6.277E-4	1.162E-3	1.009E-3	1.009E-3	1.696E-3

Delta [Ilih_A[1]]

	0krad(Si)	42krad(Si)	78krad(Si)	114krad(Si)	150krad(Si)
N° 1 (Ref)	---	-4.578E-4	-1.602E-3	-3.052E-4	-5.340E-4
N° 2 (ON)	---	-2.289E-4	-9.155E-4	-1.678E-3	-1.526E-3
N° 3 (ON)	---	6.867E-4	1.068E-3	5.341E-4	-1.525E-4
N° 4 (ON)	---	-2.289E-4	-1.450E-3	-1.144E-3	-1.450E-3
N° 5 (ON)	---	7.630E-5	3.815E-4	-2.288E-4	-1.450E-3
N° 6 (ON)	---	-1.297E-3	1.068E-3	6.104E-4	-9.918E-4
N° 7 (OFF)	---	-5.340E-4	-4.577E-4	0.000E+0	6.104E-4
N° 8 (OFF)	---	3.814E-4	-1.297E-3	-1.144E-3	-1.373E-3
N° 9 (OFF)	---	-4.578E-4	-1.526E-4	-3.815E-4	4.578E-4
N° 10 (OFF)	---	-1.907E-3	-9.918E-4	-7.629E-4	-1.068E-3
N° 11 (OFF)	---	5.340E-4	3.815E-4	3.815E-4	1.068E-3
Average (ON)	---	-1.984E-4	3.053E-5	-3.815E-4	-1.114E-3
s (ON)	---	7.190E-4	1.158E-3	1.014E-3	5.776E-4
Average+3s (ON)	---	1.959E-3	3.504E-3	2.659E-3	6.188E-4
Average-3s (ON)	---	-2.355E-3	-3.443E-3	-3.422E-3	-2.847E-3
Average (OFF)	---	-3.968E-4	-5.035E-4	-3.815E-4	-6.102E-5
s (OFF)	---	9.717E-4	6.664E-4	6.032E-4	1.088E-3
Average+3s (OFF)	---	2.518E-3	1.496E-3	1.428E-3	3.202E-3
Average-3s (OFF)	---	-3.312E-3	-2.503E-3	-2.191E-3	-3.324E-3

4. Ilih_A[2]

Ta = 25°C, Vcc = 3.3V, Vin = Vcc

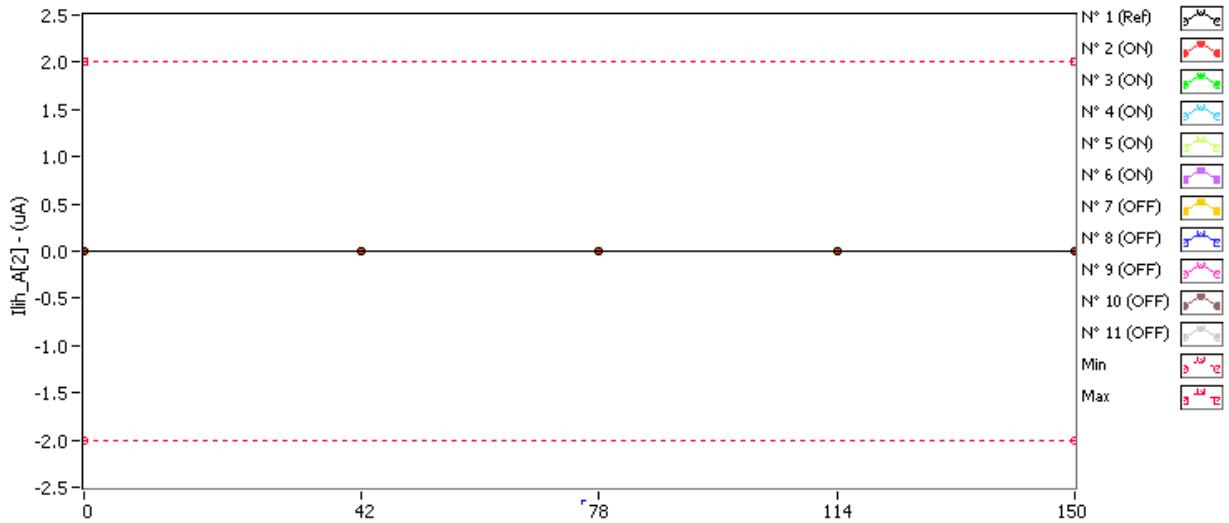

Ilih_A[2] . (uA) Min = -2.0 Max = 2.0

	0krad(Si)	42krad(Si)	78krad(Si)	114krad(Si)	150krad(Si)
N° 1 (Ref)	3.145E-3	2.916E-3	1.848E-3	2.459E-3	2.382E-3
N° 2 (ON)	1.162E-3	2.154E-3	1.085E-3	2.916E-3	2.459E-3
N° 3 (ON)	2.535E-3	2.077E-3	2.077E-3	1.238E-3	1.696E-3
N° 4 (ON)	1.925E-3	2.459E-3	1.620E-3	2.993E-3	2.306E-3
N° 5 (ON)	9.329E-4	1.543E-3	2.306E-3	2.306E-3	2.230E-3
N° 6 (ON)	2.001E-3	3.069E-3	2.077E-3	4.595E-3	3.145E-3
N° 7 (OFF)	9.329E-4	3.145E-3	2.764E-3	1.925E-3	1.772E-3
N° 8 (OFF)	1.925E-3	2.535E-3	2.993E-3	1.314E-3	2.001E-3
N° 9 (OFF)	1.391E-3	2.230E-3	2.840E-3	1.162E-3	2.306E-3
N° 10 (OFF)	3.145E-3	1.085E-3	1.543E-3	2.993E-3	3.374E-3
N° 11 (OFF)	1.314E-3	3.069E-3	2.611E-3	2.764E-3	1.162E-3

Delta [Ilih_A[2]]

	0krad(Si)	42krad(Si)	78krad(Si)	114krad(Si)	150krad(Si)
N° 1 (Ref)	---	-2.289E-4	-1.297E-3	-6.867E-4	-7.630E-4
N° 2 (ON)	---	9.919E-4	-7.630E-5	1.755E-3	1.297E-3
N° 3 (ON)	---	-4.577E-4	-4.577E-4	-1.297E-3	-8.392E-4
N° 4 (ON)	---	5.340E-4	-3.052E-4	1.068E-3	3.815E-4
N° 5 (ON)	---	6.103E-4	1.373E-3	1.373E-3	1.297E-3
N° 6 (ON)	---	1.068E-3	7.630E-5	2.594E-3	1.144E-3
N° 7 (OFF)	---	2.213E-3	1.831E-3	9.918E-4	8.392E-4
N° 8 (OFF)	---	6.103E-4	1.068E-3	-6.104E-4	7.630E-5
N° 9 (OFF)	---	8.393E-4	1.450E-3	-2.289E-4	9.156E-4
N° 10 (OFF)	---	-2.060E-3	-1.602E-3	-1.526E-4	2.289E-4
N° 11 (OFF)	---	1.755E-3	1.297E-3	1.450E-3	-1.526E-4
Average (ON)	---	5.493E-4	1.221E-4	1.099E-3	6.561E-4
s (ON)	---	6.089E-4	7.290E-4	1.456E-3	9.181E-4
Average+3s (ON)	---	2.376E-3	2.309E-3	5.467E-3	3.410E-3
Average-3s (ON)	---	-1.277E-3	-2.065E-3	-3.270E-3	-2.098E-3
Average (OFF)	---	6.714E-4	8.087E-4	2.899E-4	3.815E-4
s (OFF)	---	1.661E-3	1.376E-3	8.822E-4	4.734E-4
Average+3s (OFF)	---	5.656E-3	4.937E-3	2.937E-3	1.802E-3
Average-3s (OFF)	---	-4.313E-3	-3.319E-3	-2.357E-3	-1.039E-3

5. Ilih_A[3]

Ta = 25°C, Vcc = 3.3V, Vin = Vcc

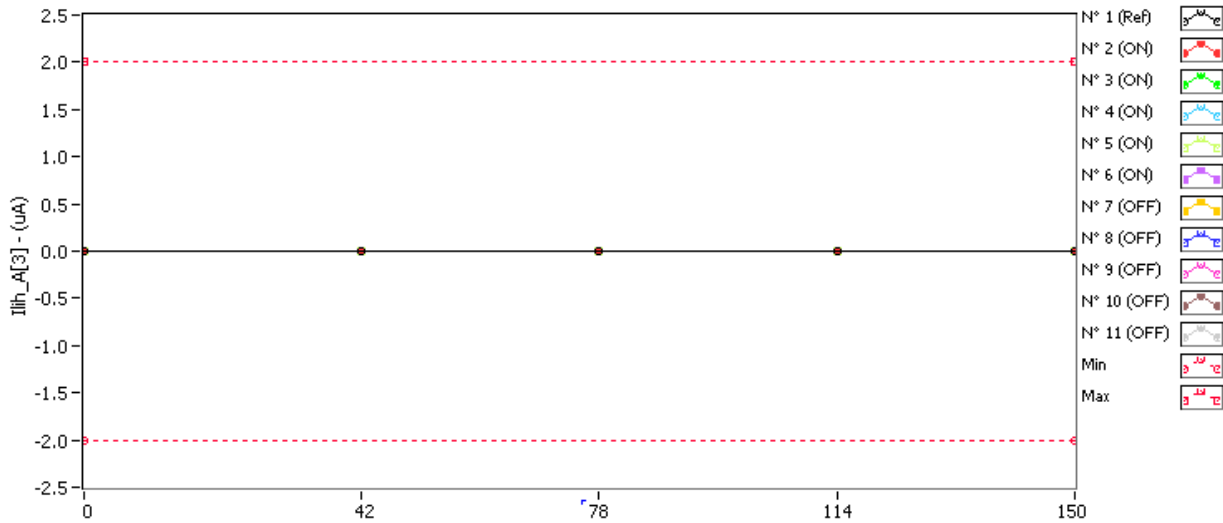

Ilih_A[3] . (uA) Min = -2.0 Max = 2.0

	0krad(Si)	42krad(Si)	78krad(Si)	114krad(Si)	150krad(Si)
N° 1 (Ref)	3.832E-3	1.696E-3	1.696E-3	3.145E-3	2.154E-3
N° 2 (ON)	3.069E-3	3.145E-3	2.459E-3	1.314E-3	2.230E-3
N° 3 (ON)	3.069E-3	1.620E-3	1.620E-3	2.611E-3	1.696E-3
N° 4 (ON)	2.611E-3	1.772E-3	2.459E-3	1.848E-3	2.001E-3
N° 5 (ON)	2.611E-3	2.764E-3	2.916E-3	1.772E-3	2.611E-3
N° 6 (ON)	3.298E-3	3.527E-3	3.832E-3	2.611E-3	2.993E-3
N° 7 (OFF)	3.069E-3	3.222E-3	2.154E-3	3.222E-3	2.459E-3
N° 8 (OFF)	1.620E-3	3.603E-3	2.077E-3	3.451E-3	2.459E-3
N° 9 (OFF)	2.077E-3	2.764E-3	2.306E-3	1.925E-3	3.451E-3
N° 10 (OFF)	1.620E-3	1.848E-3	1.848E-3	2.993E-3	2.306E-3
N° 11 (OFF)	2.154E-3	2.840E-3	2.077E-3	2.230E-3	3.374E-3

Delta [Ilih_A[3]]

	0krad(Si)	42krad(Si)	78krad(Si)	114krad(Si)	150krad(Si)
N° 1 (Ref)	---	-2.136E-3	-2.136E-3	-6.866E-4	-1.678E-3
N° 2 (ON)	---	7.630E-5	-6.104E-4	-1.755E-3	-8.392E-4
N° 3 (ON)	---	-1.450E-3	-1.450E-3	-4.578E-4	-1.373E-3
N° 4 (ON)	---	-8.392E-4	-1.526E-4	-7.629E-4	-6.103E-4
N° 5 (ON)	---	1.526E-4	3.052E-4	-8.392E-4	0.000E+0
N° 6 (ON)	---	2.289E-4	5.340E-4	-6.867E-4	-3.052E-4
N° 7 (OFF)	---	1.526E-4	-9.155E-4	1.526E-4	-6.104E-4
N° 8 (OFF)	---	1.984E-3	4.578E-4	1.831E-3	8.392E-4
N° 9 (OFF)	---	6.866E-4	2.289E-4	-1.526E-4	1.373E-3
N° 10 (OFF)	---	2.289E-4	2.289E-4	1.373E-3	6.867E-4
N° 11 (OFF)	---	6.866E-4	-7.630E-5	7.630E-5	1.221E-3
Average (ON)	---	-3.662E-4	-2.747E-4	-9.003E-4	-6.256E-4
s (ON)	---	7.444E-4	7.903E-4	4.986E-4	5.242E-4
Average+3s (ON)	---	1.867E-3	2.096E-3	5.954E-4	9.469E-4
Average-3s (ON)	---	-2.599E-3	-2.646E-3	-2.396E-3	-2.198E-3
Average (OFF)	---	7.477E-4	-1.524E-5	6.561E-4	7.019E-4
s (OFF)	---	7.345E-4	5.379E-4	8.858E-4	7.844E-4
Average+3s (OFF)	---	2.951E-3	1.598E-3	3.314E-3	3.055E-3
Average-3s (OFF)	---	-1.456E-3	-1.629E-3	-2.001E-3	-1.651E-3

6. Ilih_A[4]

Ta = 25°C, Vcc = 3.3V, Vin = Vcc

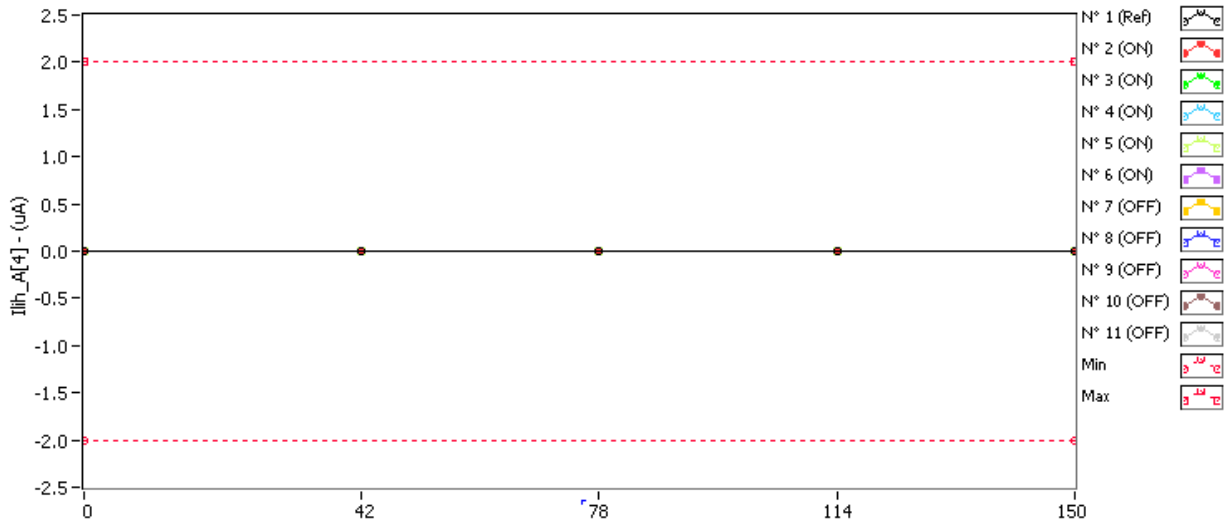

Ilih_A[4] . (uA) Min = -2.0 Max = 2.0

	0krad(Si)	42krad(Si)	78krad(Si)	114krad(Si)	150krad(Si)
N° 1 (Ref)	7.040E-4	5.514E-4	1.772E-3	2.688E-3	1.085E-3
N° 2 (ON)	3.069E-3	2.306E-3	1.314E-3	9.329E-4	7.803E-4
N° 3 (ON)	1.925E-3	2.688E-3	1.696E-3	2.535E-3	2.764E-3
N° 4 (ON)	2.077E-3	2.077E-3	7.803E-4	2.535E-3	1.925E-3
N° 5 (ON)	2.230E-3	2.611E-3	1.696E-3	1.620E-3	1.543E-3
N° 6 (ON)	2.382E-3	8.566E-4	2.154E-3	2.230E-3	2.382E-3
N° 7 (OFF)	1.238E-3	2.306E-3	6.277E-4	2.230E-3	1.467E-3
N° 8 (OFF)	9.329E-4	1.772E-3	9.329E-4	9.329E-4	1.391E-3
N° 9 (OFF)	1.391E-3	2.535E-3	2.230E-3	1.314E-3	2.611E-3
N° 10 (OFF)	1.391E-3	2.154E-3	7.040E-4	2.764E-3	1.467E-3
N° 11 (OFF)	2.306E-3	2.764E-3	1.391E-3	1.009E-3	1.925E-3

Delta [Ilih_A[4]]

	0krad(Si)	42krad(Si)	78krad(Si)	114krad(Si)	150krad(Si)
N° 1 (Ref)	---	-1.526E-4	1.068E-3	1.984E-3	3.814E-4
N° 2 (ON)	---	-7.629E-4	-1.755E-3	-2.136E-3	-2.289E-3
N° 3 (ON)	---	7.629E-4	-2.289E-4	6.103E-4	8.392E-4
N° 4 (ON)	---	0.000E+0	-1.297E-3	4.577E-4	-1.526E-4
N° 5 (ON)	---	3.814E-4	-5.341E-4	-6.104E-4	-6.867E-4
N° 6 (ON)	---	-1.526E-3	-2.288E-4	-1.525E-4	0.000E+0
N° 7 (OFF)	---	1.068E-3	-6.103E-4	9.919E-4	2.289E-4
N° 8 (OFF)	---	8.392E-4	0.000E+0	0.000E+0	4.577E-4
N° 9 (OFF)	---	1.144E-3	8.393E-4	-7.630E-5	1.221E-3
N° 10 (OFF)	---	7.630E-4	-6.866E-4	1.373E-3	7.630E-5
N° 11 (OFF)	---	4.577E-4	-9.156E-4	-1.297E-3	-3.815E-4
Average (ON)	---	-2.289E-4	-8.087E-4	-3.662E-4	-4.578E-4
s (ON)	---	9.187E-4	6.858E-4	1.103E-3	1.161E-3
Average+3s (ON)	---	2.527E-3	1.249E-3	2.944E-3	3.025E-3
Average-3s (ON)	---	-2.985E-3	-2.866E-3	-3.677E-3	-3.940E-3
Average (OFF)	---	8.545E-4	-2.746E-4	1.984E-4	3.204E-4
s (OFF)	---	2.719E-4	7.088E-4	1.044E-3	5.895E-4
Average+3s (OFF)	---	1.670E-3	1.852E-3	3.331E-3	2.089E-3
Average-3s (OFF)	---	3.874E-5	-2.401E-3	-2.934E-3	-1.448E-3

7. Ilih_A[5]

Ta = 25°C, Vcc = 3.3V, Vin = Vcc

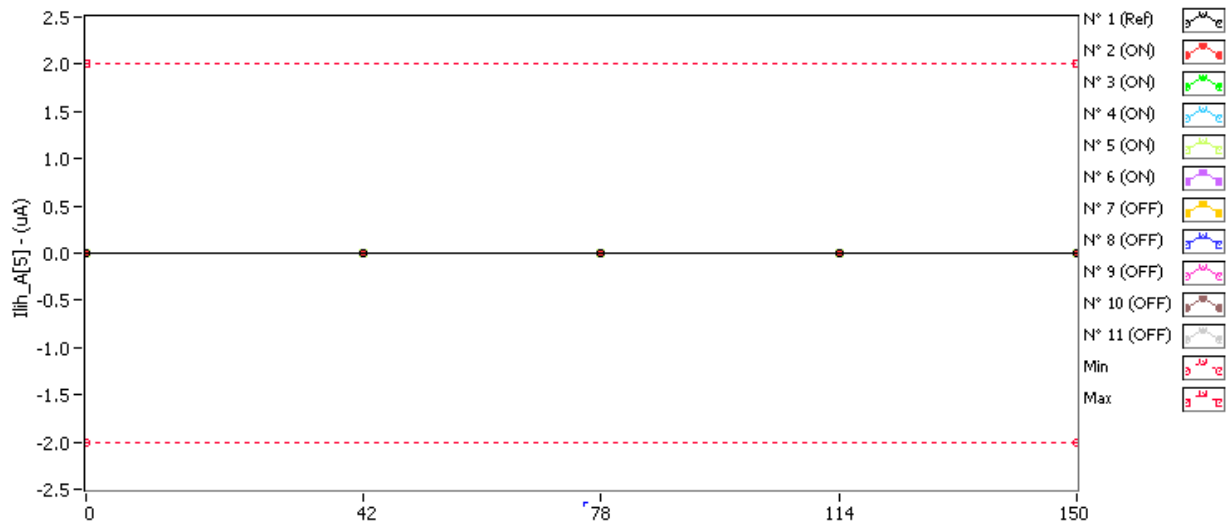

Ilih_A[5] . (uA) Min = -2.0 Max = 2.0

	0krad(Si)	42krad(Si)	78krad(Si)	114krad(Si)	150krad(Si)
N° 1 (Ref)	2.154E-3	2.382E-3	1.620E-3	2.230E-3	1.696E-3
N° 2 (ON)	2.459E-3	2.001E-3	1.772E-3	1.162E-3	2.382E-3
N° 3 (ON)	2.916E-3	1.085E-3	1.391E-3	1.925E-3	3.069E-3
N° 4 (ON)	3.145E-3	2.688E-3	8.566E-4	2.306E-3	2.001E-3
N° 5 (ON)	2.993E-3	2.764E-3	1.848E-3	1.696E-3	2.459E-3
N° 6 (ON)	1.085E-3	2.001E-3	1.467E-3	2.916E-3	3.451E-3
N° 7 (OFF)	1.467E-3	2.459E-3	1.848E-3	2.001E-3	2.382E-3
N° 8 (OFF)	2.382E-3	2.535E-3	1.620E-3	1.238E-3	7.803E-4
N° 9 (OFF)	2.154E-3	2.459E-3	2.230E-3	1.925E-3	2.688E-3
N° 10 (OFF)	2.688E-3	2.077E-3	1.009E-3	1.696E-3	7.803E-4
N° 11 (OFF)	2.459E-3	1.162E-3	2.688E-3	2.382E-3	1.238E-3

Delta [Ilih_A[5]]

	0krad(Si)	42krad(Si)	78krad(Si)	114krad(Si)	150krad(Si)
N° 1 (Ref)	---	2.288E-4	-5.341E-4	7.630E-5	-4.578E-4
N° 2 (ON)	---	-4.577E-4	-6.866E-4	-1.297E-3	-7.630E-5
N° 3 (ON)	---	-1.831E-3	-1.526E-3	-9.918E-4	1.526E-4
N° 4 (ON)	---	-4.578E-4	-2.289E-3	-8.392E-4	-1.144E-3
N° 5 (ON)	---	-2.289E-4	-1.144E-3	-1.297E-3	-5.341E-4
N° 6 (ON)	---	9.156E-4	3.815E-4	1.831E-3	2.365E-3
N° 7 (OFF)	---	9.918E-4	3.815E-4	5.341E-4	9.155E-4
N° 8 (OFF)	---	1.526E-4	-7.629E-4	-1.144E-3	-1.602E-3
N° 9 (OFF)	---	3.051E-4	7.630E-5	-2.289E-4	5.340E-4
N° 10 (OFF)	---	-6.103E-4	-1.678E-3	-9.918E-4	-1.907E-3
N° 11 (OFF)	---	-1.297E-3	2.289E-4	-7.630E-5	-1.221E-3
Average (ON)	---	-4.120E-4	-1.053E-3	-5.188E-4	1.526E-4
s (ON)	---	9.765E-4	9.939E-4	1.328E-3	1.332E-3
Average+3s (ON)	---	2.517E-3	1.929E-3	3.467E-3	4.150E-3
Average-3s (ON)	---	-3.341E-3	-4.035E-3	-4.504E-3	-3.845E-3
Average (OFF)	---	-9.156E-5	-3.509E-4	-3.815E-4	-6.561E-4
s (OFF)	---	8.822E-4	8.642E-4	6.909E-4	1.291E-3
Average+3s (OFF)	---	2.555E-3	2.242E-3	1.691E-3	3.217E-3
Average-3s (OFF)	---	-2.738E-3	-2.943E-3	-2.454E-3	-4.529E-3

8. Ilih_A[6]

Ta = 25°C, Vcc = 3.3V, Vin = Vcc

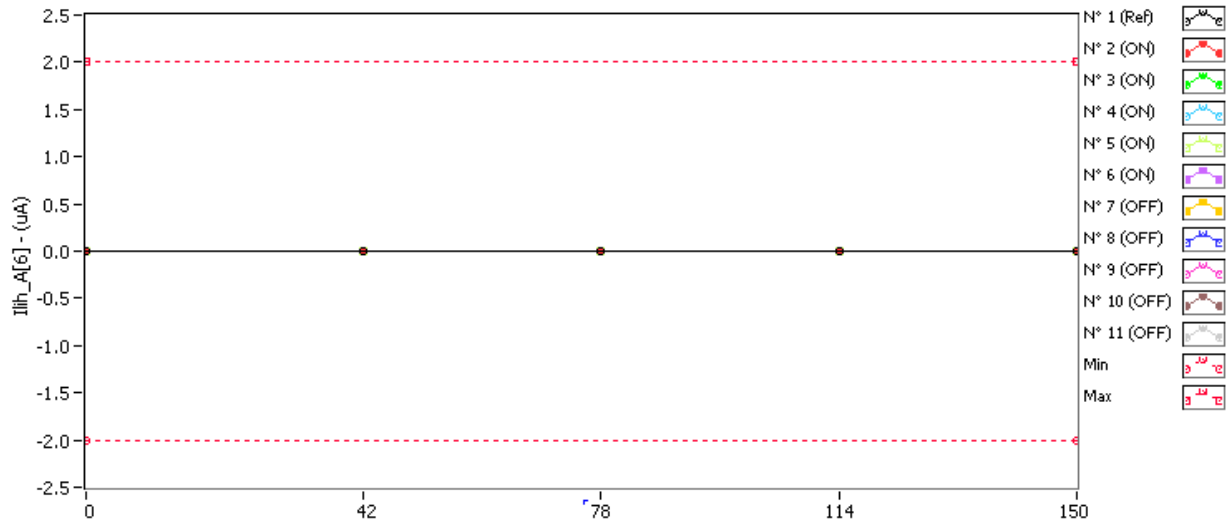

Ilih_A[6] . (uA) Min = -2.0 Max = 2.0

	0krad(Si)	42krad(Si)	78krad(Si)	114krad(Si)	150krad(Si)
N° 1 (Ref)	2.993E-3	3.222E-3	1.772E-3	2.840E-3	2.688E-3
N° 2 (ON)	2.688E-3	2.306E-3	2.611E-3	2.993E-3	2.688E-3
N° 3 (ON)	2.535E-3	2.916E-3	2.535E-3	2.001E-3	2.688E-3
N° 4 (ON)	1.085E-3	1.314E-3	2.382E-3	1.009E-3	2.764E-3
N° 5 (ON)	1.772E-3	1.238E-3	1.314E-3	2.764E-3	2.535E-3
N° 6 (ON)	1.925E-3	1.925E-3	2.382E-3	2.993E-3	3.222E-3
N° 7 (OFF)	1.925E-3	1.620E-3	2.001E-3	1.925E-3	2.688E-3
N° 8 (OFF)	1.467E-3	2.459E-3	1.772E-3	3.374E-3	1.467E-3
N° 9 (OFF)	2.993E-3	1.848E-3	2.688E-3	2.688E-3	1.543E-3
N° 10 (OFF)	8.566E-4	3.374E-3	2.230E-3	2.840E-3	1.238E-3
N° 11 (OFF)	1.391E-3	2.154E-3	1.467E-3	2.154E-3	2.077E-3

Delta [Ilih_A[6]]

	0krad(Si)	42krad(Si)	78krad(Si)	114krad(Si)	150krad(Si)
N° 1 (Ref)	---	2.289E-4	-1.221E-3	-1.526E-4	-3.052E-4
N° 2 (ON)	---	-3.814E-4	-7.630E-5	3.052E-4	0.000E+0
N° 3 (ON)	---	3.815E-4	0.000E+0	-5.340E-4	1.526E-4
N° 4 (ON)	---	2.289E-4	1.297E-3	-7.620E-5	1.679E-3
N° 5 (ON)	---	-5.341E-4	-4.578E-4	9.918E-4	7.629E-4
N° 6 (ON)	---	0.000E+0	4.577E-4	1.068E-3	1.297E-3
N° 7 (OFF)	---	-3.052E-4	7.630E-5	0.000E+0	7.629E-4
N° 8 (OFF)	---	9.918E-4	3.052E-4	1.907E-3	0.000E+0
N° 9 (OFF)	---	-1.144E-3	-3.052E-4	-3.052E-4	-1.450E-3
N° 10 (OFF)	---	2.518E-3	1.373E-3	1.984E-3	3.814E-4
N° 11 (OFF)	---	7.630E-4	7.630E-5	7.630E-4	6.867E-4
Average (ON)	---	-6.102E-5	2.441E-4	3.510E-4	7.782E-4
s (ON)	---	3.905E-4	6.725E-4	6.879E-4	7.206E-4
Average+3s (ON)	---	1.111E-3	2.262E-3	2.415E-3	2.940E-3
Average-3s (ON)	---	-1.233E-3	-1.773E-3	-1.713E-3	-1.384E-3
Average (OFF)	---	5.646E-4	3.052E-4	8.698E-4	7.629E-4
s (OFF)	---	1.389E-3	6.361E-4	1.057E-3	9.043E-4
Average+3s (OFF)	---	4.731E-3	2.213E-3	4.040E-3	2.789E-3
Average-3s (OFF)	---	-3.601E-3	-1.603E-3	-2.300E-3	-2.637E-3

9. Ilih_A[7]

Ta = 25°C, Vcc = 3.3V, Vin = Vcc

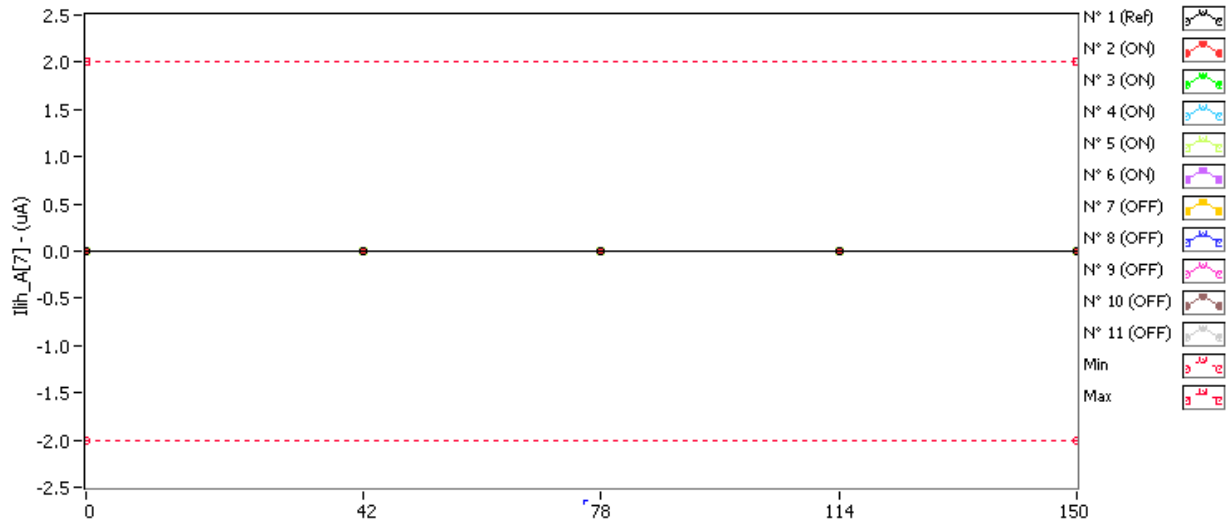

Ilih_A[7] . (uA) Min = -2.0 Max = 2.0

	0krad(Si)	42krad(Si)	78krad(Si)	114krad(Si)	150krad(Si)
N° 1 (Ref)	2.535E-3	2.077E-3	3.908E-3	2.306E-3	1.314E-3
N° 2 (ON)	2.459E-3	3.145E-3	2.535E-3	2.001E-3	2.916E-3
N° 3 (ON)	2.611E-3	1.391E-3	1.543E-3	2.230E-3	2.459E-3
N° 4 (ON)	1.467E-3	2.077E-3	3.832E-3	3.222E-3	3.756E-3
N° 5 (ON)	2.611E-3	2.306E-3	1.772E-3	2.688E-3	2.993E-3
N° 6 (ON)	1.620E-3	2.230E-3	2.077E-3	2.154E-3	2.001E-3
N° 7 (OFF)	1.772E-3	3.451E-3	1.543E-3	3.069E-3	2.916E-3
N° 8 (OFF)	3.069E-3	3.298E-3	2.916E-3	3.145E-3	2.001E-3
N° 9 (OFF)	3.069E-3	1.848E-3	1.696E-3	3.679E-3	2.306E-3
N° 10 (OFF)	1.314E-3	2.993E-3	3.527E-3	1.391E-3	2.382E-3
N° 11 (OFF)	1.543E-3	2.382E-3	1.696E-3	1.696E-3	1.696E-3

Delta [Ilih_A[7]]

	0krad(Si)	42krad(Si)	78krad(Si)	114krad(Si)	150krad(Si)
N° 1 (Ref)	---	-4.577E-4	1.373E-3	-2.288E-4	-1.221E-3
N° 2 (ON)	---	6.867E-4	7.630E-5	-4.577E-4	4.578E-4
N° 3 (ON)	---	-1.221E-3	-1.068E-3	-3.814E-4	-1.526E-4
N° 4 (ON)	---	6.104E-4	2.365E-3	1.755E-3	2.289E-3
N° 5 (ON)	---	-3.051E-4	-8.392E-4	7.630E-5	3.815E-4
N° 6 (ON)	---	6.104E-4	4.578E-4	5.341E-4	3.815E-4
N° 7 (OFF)	---	1.678E-3	-2.289E-4	1.297E-3	1.144E-3
N° 8 (OFF)	---	2.289E-4	-1.526E-4	7.630E-5	-1.068E-3
N° 9 (OFF)	---	-1.221E-3	-1.373E-3	6.103E-4	-7.629E-4
N° 10 (OFF)	---	1.678E-3	2.213E-3	7.630E-5	1.068E-3
N° 11 (OFF)	---	8.392E-4	1.526E-4	1.526E-4	1.526E-4
Average (ON)	---	7.634E-5	1.984E-4	3.052E-4	6.714E-4
s (ON)	---	8.323E-4	1.365E-3	9.027E-4	9.366E-4
Average+3s (ON)	---	2.573E-3	4.295E-3	3.013E-3	3.481E-3
Average-3s (ON)	---	-2.421E-3	-3.898E-3	-2.403E-3	-2.138E-3
Average (OFF)	---	6.409E-4	1.221E-4	4.425E-4	1.068E-4
s (OFF)	---	1.207E-3	1.304E-3	5.269E-4	1.017E-3
Average+3s (OFF)	---	4.262E-3	4.035E-3	2.023E-3	3.159E-3
Average-3s (OFF)	---	-2.980E-3	-3.791E-3	-1.138E-3	-2.945E-3

10. Ilih_A[8]

Ta = 25°C, Vcc = 3.3V, Vin = Vcc

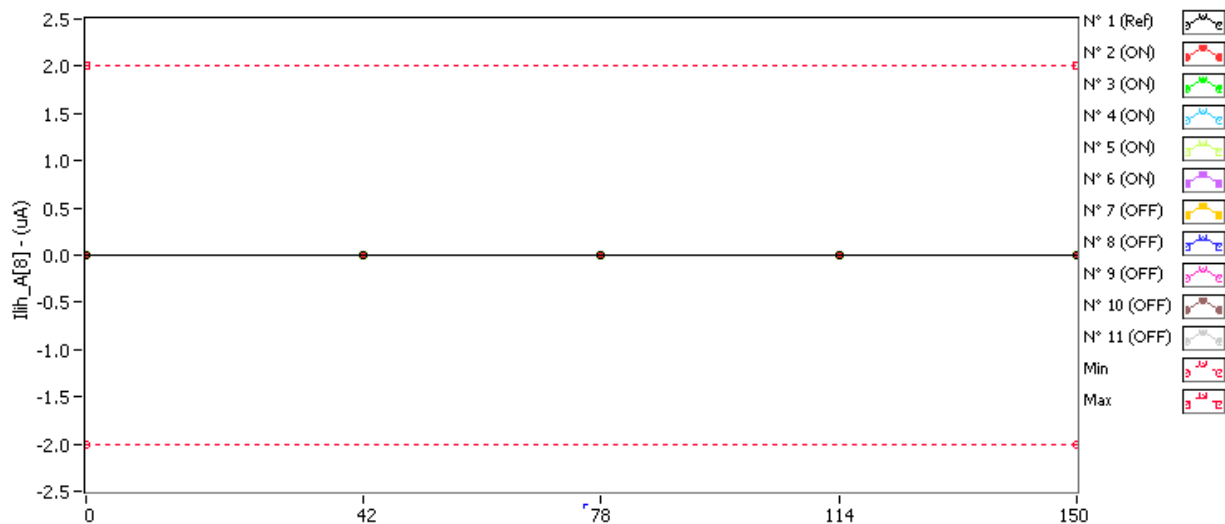

Ilih_A[8] . (uA) Min = -2.0 Max = 2.0

	0krad(Si)	42krad(Si)	78krad(Si)	114krad(Si)	150krad(Si)
N° 1 (Ref)	3.069E-3	1.162E-3	3.145E-3	3.527E-3	2.611E-3
N° 2 (ON)	1.162E-3	1.620E-3	3.298E-3	2.001E-3	3.451E-3
N° 3 (ON)	2.382E-3	2.230E-3	2.993E-3	1.696E-3	2.077E-3
N° 4 (ON)	1.085E-3	2.077E-3	1.925E-3	2.764E-3	3.451E-3
N° 5 (ON)	2.382E-3	1.772E-3	3.298E-3	2.459E-3	1.620E-3
N° 6 (ON)	1.391E-3	1.467E-3	1.848E-3	1.391E-3	1.314E-3
N° 7 (OFF)	2.916E-3	1.925E-3	3.298E-3	2.459E-3	1.543E-3
N° 8 (OFF)	3.527E-3	2.688E-3	2.611E-3	3.451E-3	3.451E-3
N° 9 (OFF)	1.772E-3	1.391E-3	2.764E-3	1.543E-3	2.688E-3
N° 10 (OFF)	3.145E-3	3.145E-3	2.535E-3	2.230E-3	1.467E-3
N° 11 (OFF)	3.069E-3	2.154E-3	2.611E-3	1.848E-3	2.688E-3

Delta [Ilih_A[8]]

	0krad(Si)	42krad(Si)	78krad(Si)	114krad(Si)	150krad(Si)
N° 1 (Ref)	---	-1.907E-3	7.630E-5	4.578E-4	-4.578E-4
N° 2 (ON)	---	4.578E-4	2.136E-3	8.393E-4	2.289E-3
N° 3 (ON)	---	-1.525E-4	6.104E-4	-6.866E-4	-3.051E-4
N° 4 (ON)	---	9.919E-4	8.393E-4	1.679E-3	2.365E-3
N° 5 (ON)	---	-6.103E-4	9.156E-4	7.630E-5	-7.629E-4
N° 6 (ON)	---	7.630E-5	4.578E-4	0.000E+0	-7.630E-5
N° 7 (OFF)	---	-9.918E-4	3.815E-4	-4.578E-4	-1.373E-3
N° 8 (OFF)	---	-8.393E-4	-9.156E-4	-7.630E-5	-7.630E-5
N° 9 (OFF)	---	-3.815E-4	9.918E-4	-2.289E-4	9.155E-4
N° 10 (OFF)	---	0.000E+0	-6.104E-4	-9.155E-4	-1.679E-3
N° 11 (OFF)	---	-9.155E-4	-4.578E-4	-1.221E-3	-3.815E-4
Average (ON)	---	1.526E-4	9.919E-4	3.815E-4	7.020E-4
s (ON)	---	6.080E-4	6.651E-4	9.043E-4	1.504E-3
Average+3s (ON)	---	1.977E-3	2.987E-3	3.095E-3	5.215E-3
Average-3s (ON)	---	-1.671E-3	-1.003E-3	-2.332E-3	-3.811E-3
Average (OFF)	---	-6.256E-4	-1.221E-4	-5.798E-4	-5.188E-4
s (OFF)	---	4.227E-4	7.866E-4	4.783E-4	1.042E-3
Average+3s (OFF)	---	6.425E-4	2.238E-3	8.550E-4	2.609E-3
Average-3s (OFF)	---	-1.894E-3	-2.482E-3	-2.015E-3	-3.646E-3

11. Ilih_A[9]

Ta = 25°C, Vcc = 3.3V, Vin = Vcc

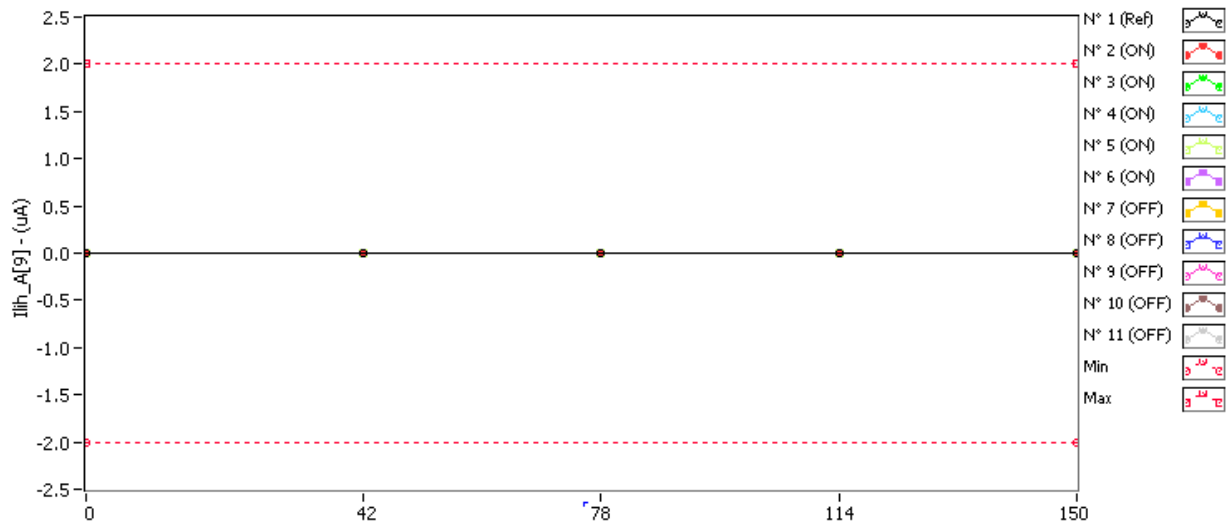

Ilih_A[9] . (uA) Min = -2.0 Max = 2.0

	0krad(Si)	42krad(Si)	78krad(Si)	114krad(Si)	150krad(Si)
N° 1 (Ref)	2.535E-3	1.009E-3	2.611E-3	2.306E-3	5.514E-4
N° 2 (ON)	9.329E-4	2.154E-3	2.459E-3	2.764E-3	1.772E-3
N° 3 (ON)	1.848E-3	1.009E-3	2.611E-3	1.314E-3	1.543E-3
N° 4 (ON)	1.314E-3	1.314E-3	2.001E-3	2.382E-3	2.764E-3
N° 5 (ON)	2.154E-3	2.230E-3	2.230E-3	1.009E-3	1.467E-3
N° 6 (ON)	7.040E-4	5.514E-4	1.772E-3	1.925E-3	7.803E-4
N° 7 (OFF)	1.848E-3	2.230E-3	1.467E-3	2.306E-3	2.382E-3
N° 8 (OFF)	1.314E-3	5.514E-4	9.329E-4	1.162E-3	1.162E-3
N° 9 (OFF)	9.329E-4	1.925E-3	2.154E-3	1.162E-3	9.329E-4
N° 10 (OFF)	2.382E-3	2.230E-3	1.620E-3	2.688E-3	1.009E-3
N° 11 (OFF)	2.459E-3	2.382E-3	2.535E-3	2.230E-3	1.009E-3

Delta [Ilih_A[9]]

	0krad(Si)	42krad(Si)	78krad(Si)	114krad(Si)	150krad(Si)
N° 1 (Ref)	---	-1.526E-3	7.630E-5	-2.288E-4	-1.984E-3
N° 2 (ON)	---	1.221E-3	1.526E-3	1.831E-3	8.392E-4
N° 3 (ON)	---	-8.392E-4	7.629E-4	-5.341E-4	-3.052E-4
N° 4 (ON)	---	0.000E+0	6.867E-4	1.068E-3	1.450E-3
N° 5 (ON)	---	7.630E-5	7.630E-5	-1.144E-3	-6.867E-4
N° 6 (ON)	---	-1.526E-4	1.068E-3	1.221E-3	7.629E-5
N° 7 (OFF)	---	3.815E-4	-3.815E-4	4.578E-4	5.340E-4
N° 8 (OFF)	---	-7.629E-4	-3.814E-4	-1.526E-4	-1.526E-4
N° 9 (OFF)	---	9.918E-4	1.221E-3	2.288E-4	0.000E+0
N° 10 (OFF)	---	-1.525E-4	-7.629E-4	3.052E-4	-1.373E-3
N° 11 (OFF)	---	-7.630E-5	7.630E-5	-2.288E-4	-1.449E-3
Average (ON)	---	6.105E-5	8.240E-4	4.883E-4	2.746E-4
s (ON)	---	7.425E-4	5.324E-4	1.264E-3	8.659E-4
Average+3s (ON)	---	2.288E-3	2.421E-3	4.279E-3	2.872E-3
Average-3s (ON)	---	-2.166E-3	-7.732E-4	-3.302E-3	-2.323E-3
Average (OFF)	---	7.633E-5	-4.576E-5	1.221E-4	-4.883E-4
s (OFF)	---	6.541E-4	7.679E-4	2.984E-4	8.808E-4
Average+3s (OFF)	---	2.039E-3	2.258E-3	1.017E-3	2.154E-3
Average-3s (OFF)	---	-1.886E-3	-2.349E-3	-7.732E-4	-3.131E-3

12. Ilih_A[10]

Ta = 25°C, Vcc = 3.3V, Vin = Vcc

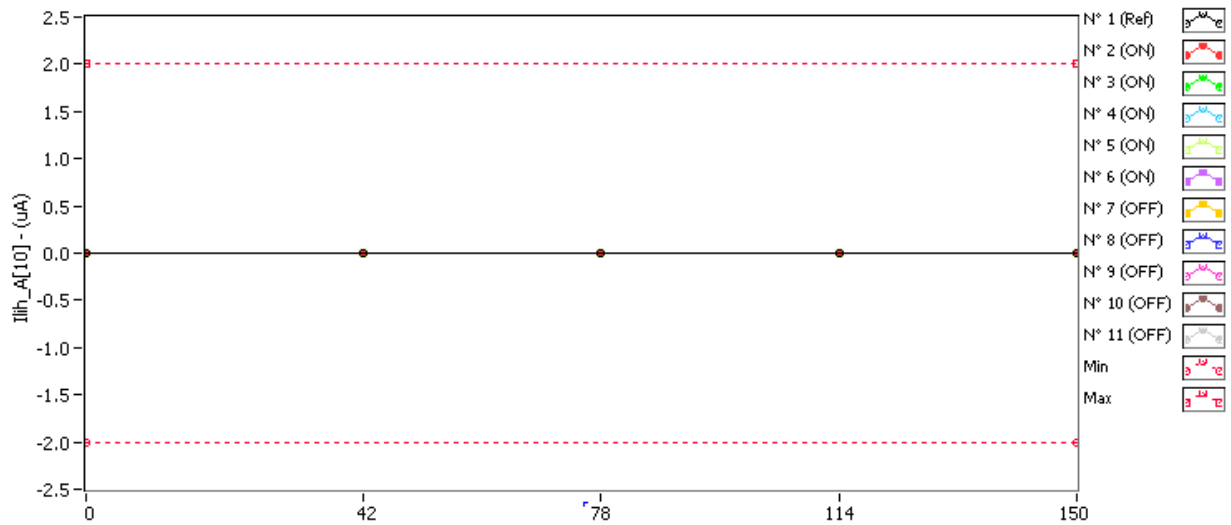

Ilih_A[10] . (uA) Min = -2.0 Max = 2.0

	0krad(Si)	42krad(Si)	78krad(Si)	114krad(Si)	150krad(Si)
N° 1 (Ref)	2.840E-3	2.688E-3	1.391E-3	3.222E-3	9.329E-4
N° 2 (ON)	1.085E-3	1.848E-3	1.543E-3	2.001E-3	2.001E-3
N° 3 (ON)	6.277E-4	1.925E-3	2.535E-3	2.535E-3	2.230E-3
N° 4 (ON)	1.848E-3	1.238E-3	3.222E-3	1.772E-3	2.764E-3
N° 5 (ON)	1.314E-3	2.459E-3	8.566E-4	1.696E-3	2.688E-3
N° 6 (ON)	2.535E-3	2.001E-3	6.277E-4	2.688E-3	2.154E-3
N° 7 (OFF)	1.696E-3	2.001E-3	2.916E-3	1.620E-3	1.620E-3
N° 8 (OFF)	8.566E-4	6.277E-4	1.162E-3	1.314E-3	1.696E-3
N° 9 (OFF)	2.154E-3	2.459E-3	1.085E-3	2.230E-3	2.154E-3
N° 10 (OFF)	1.314E-3	1.314E-3	2.001E-3	2.306E-3	2.764E-3
N° 11 (OFF)	1.620E-3	1.848E-3	1.085E-3	1.848E-3	2.535E-3

Delta [Ilih_A[10]]

	0krad(Si)	42krad(Si)	78krad(Si)	114krad(Si)	150krad(Si)
N° 1 (Ref)	---	-1.526E-4	-1.450E-3	3.815E-4	-1.907E-3
N° 2 (ON)	---	7.630E-4	4.578E-4	9.156E-4	9.156E-4
N° 3 (ON)	---	1.297E-3	1.907E-3	1.907E-3	1.602E-3
N° 4 (ON)	---	-6.104E-4	1.373E-3	-7.630E-5	9.155E-4
N° 5 (ON)	---	1.144E-3	-4.577E-4	3.815E-4	1.373E-3
N° 6 (ON)	---	-5.340E-4	-1.907E-3	1.526E-4	-3.814E-4
N° 7 (OFF)	---	3.052E-4	1.221E-3	-7.630E-5	-7.630E-5
N° 8 (OFF)	---	-2.289E-4	3.051E-4	4.577E-4	8.392E-4
N° 9 (OFF)	---	3.051E-4	-1.068E-3	7.630E-5	0.000E+0
N° 10 (OFF)	---	0.000E+0	6.867E-4	9.919E-4	1.450E-3
N° 11 (OFF)	---	2.289E-4	-5.341E-4	2.289E-4	9.155E-4
Average (ON)	---	4.120E-4	2.747E-4	6.561E-4	8.850E-4
s (ON)	---	9.197E-4	1.517E-3	7.903E-4	7.679E-4
Average+3s (ON)	---	3.171E-3	4.825E-3	3.027E-3	3.189E-3
Average-3s (ON)	---	-2.347E-3	-4.276E-3	-1.715E-3	-1.419E-3
Average (OFF)	---	1.221E-4	1.220E-4	3.357E-4	6.256E-4
s (OFF)	---	2.327E-4	9.228E-4	4.165E-4	6.505E-4
Average+3s (OFF)	---	8.200E-4	2.891E-3	1.585E-3	2.577E-3
Average-3s (OFF)	---	-5.759E-4	-2.647E-3	-9.138E-4	-1.326E-3

13. Ilih_A[11]

Ta = 25°C, Vcc = 3.3V, Vin = Vcc

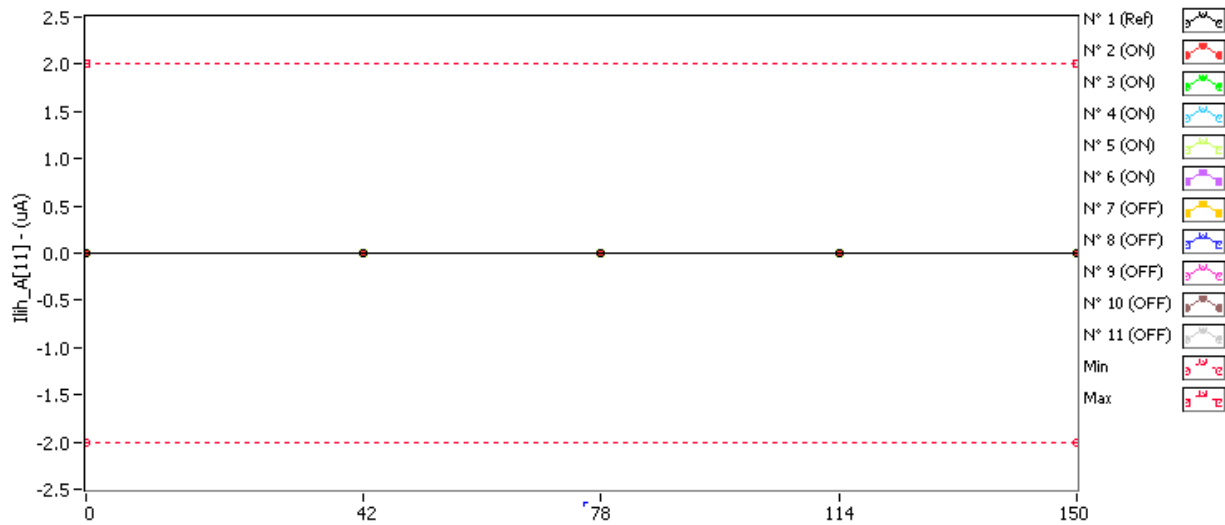

Ilih_A[11] . (uA) Min = -2.0 Max = 2.0

	0krad(Si)	42krad(Si)	78krad(Si)	114krad(Si)	150krad(Si)
N° 1 (Ref)	2.077E-3	3.756E-3	2.382E-3	2.001E-3	2.230E-3
N° 2 (ON)	2.077E-3	2.916E-3	1.696E-3	2.688E-3	2.535E-3
N° 3 (ON)	1.391E-3	2.306E-3	1.696E-3	3.374E-3	3.374E-3
N° 4 (ON)	2.306E-3	1.620E-3	1.772E-3	1.543E-3	2.535E-3
N° 5 (ON)	2.230E-3	1.848E-3	2.916E-3	3.451E-3	2.764E-3
N° 6 (ON)	1.772E-3	2.154E-3	3.374E-3	2.535E-3	3.451E-3
N° 7 (OFF)	1.696E-3	2.993E-3	2.611E-3	2.306E-3	1.696E-3
N° 8 (OFF)	2.077E-3	2.230E-3	1.467E-3	1.925E-3	2.077E-3
N° 9 (OFF)	1.543E-3	1.391E-3	3.603E-3	2.077E-3	3.069E-3
N° 10 (OFF)	2.077E-3	2.230E-3	2.459E-3	1.467E-3	3.069E-3
N° 11 (OFF)	1.925E-3	2.688E-3	2.001E-3	2.382E-3	2.840E-3

Delta [Ilih_A[11]]

	0krad(Si)	42krad(Si)	78krad(Si)	114krad(Si)	150krad(Si)
N° 1 (Ref)	---	1.678E-3	3.051E-4	-7.630E-5	1.526E-4
N° 2 (ON)	---	8.392E-4	-3.815E-4	6.103E-4	4.577E-4
N° 3 (ON)	---	9.156E-4	3.052E-4	1.984E-3	1.984E-3
N° 4 (ON)	---	-6.867E-4	-5.341E-4	-7.630E-4	2.288E-4
N° 5 (ON)	---	-3.815E-4	6.866E-4	1.221E-3	5.340E-4
N° 6 (ON)	---	3.815E-4	1.602E-3	7.629E-4	1.678E-3
N° 7 (OFF)	---	1.297E-3	9.155E-4	6.104E-4	0.000E+0
N° 8 (OFF)	---	1.526E-4	-6.104E-4	-1.526E-4	0.000E+0
N° 9 (OFF)	---	-1.526E-4	2.060E-3	5.341E-4	1.526E-3
N° 10 (OFF)	---	1.526E-4	3.814E-4	-6.104E-4	9.918E-4
N° 11 (OFF)	---	7.629E-4	7.630E-5	4.577E-4	9.155E-4
Average (ON)	---	2.136E-4	3.357E-4	7.629E-4	9.765E-4
s (ON)	---	7.206E-4	8.659E-4	1.006E-3	7.955E-4
Average+3s (ON)	---	2.375E-3	2.933E-3	3.782E-3	3.363E-3
Average-3s (ON)	---	-1.948E-3	-2.262E-3	-2.256E-3	-1.410E-3
Average (OFF)	---	4.425E-4	5.645E-4	1.678E-4	6.866E-4
s (OFF)	---	5.820E-4	1.001E-3	5.297E-4	6.695E-4
Average+3s (OFF)	---	2.189E-3	3.569E-3	1.757E-3	2.695E-3
Average-3s (OFF)	---	-1.304E-3	-2.440E-3	-1.421E-3	-1.322E-3

14. Ilih_A[12]

Ta = 25°C, Vcc = 3.3V, Vin = Vcc

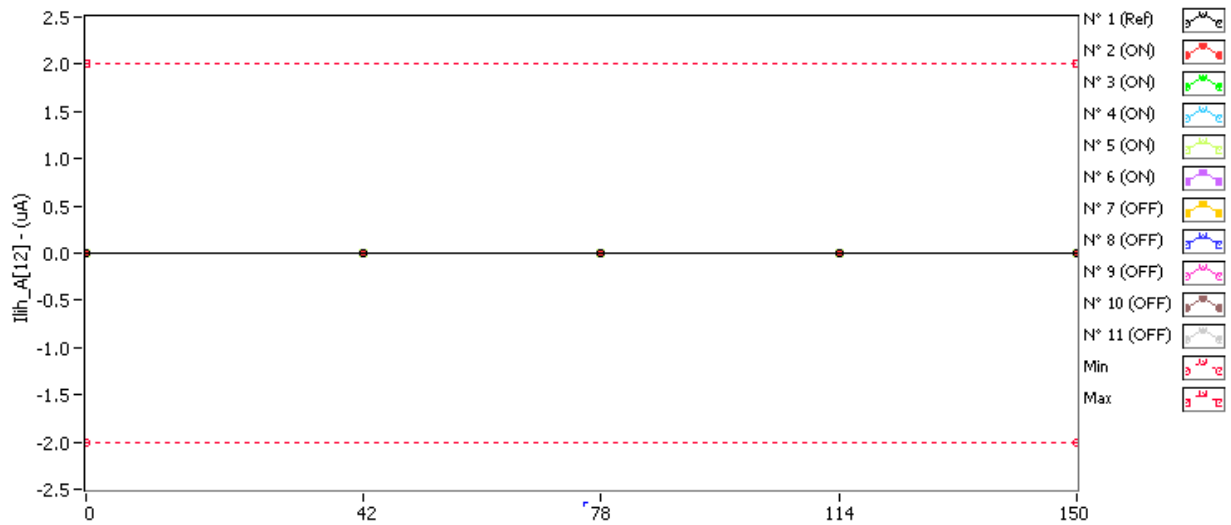

Ilih_A[12] . (uA) Min = -2.0 Max = 2.0

	0krad(Si)	42krad(Si)	78krad(Si)	114krad(Si)	150krad(Si)
N° 1 (Ref)	1.467E-3	1.314E-3	1.543E-3	2.154E-3	1.085E-3
N° 2 (ON)	9.329E-4	2.611E-3	1.543E-3	2.840E-3	2.001E-3
N° 3 (ON)	2.611E-3	2.077E-3	1.162E-3	1.925E-3	1.085E-3
N° 4 (ON)	2.306E-3	2.382E-3	2.993E-3	2.230E-3	1.162E-3
N° 5 (ON)	2.154E-3	2.611E-3	1.696E-3	1.238E-3	1.543E-3
N° 6 (ON)	1.848E-3	1.925E-3	2.459E-3	1.925E-3	1.162E-3
N° 7 (OFF)	3.527E-3	1.696E-3	2.688E-3	2.382E-3	1.696E-3
N° 8 (OFF)	1.620E-3	2.306E-3	2.459E-3	8.566E-4	1.314E-3
N° 9 (OFF)	2.306E-3	1.696E-3	3.222E-3	2.382E-3	2.840E-3
N° 10 (OFF)	1.543E-3	2.154E-3	1.009E-3	1.848E-3	1.314E-3
N° 11 (OFF)	2.001E-3	2.230E-3	3.069E-3	2.688E-3	2.840E-3

Delta [Ilih_A[12]]

	0krad(Si)	42krad(Si)	78krad(Si)	114krad(Si)	150krad(Si)
N° 1 (Ref)	---	-1.526E-4	7.630E-5	6.867E-4	-3.815E-4
N° 2 (ON)	---	1.678E-3	6.103E-4	1.907E-3	1.068E-3
N° 3 (ON)	---	-5.340E-4	-1.450E-3	-6.866E-4	-1.526E-3
N° 4 (ON)	---	7.620E-5	6.866E-4	-7.630E-5	-1.144E-3
N° 5 (ON)	---	4.577E-4	-4.578E-4	-9.156E-4	-6.104E-4
N° 6 (ON)	---	7.630E-5	6.103E-4	7.630E-5	-6.867E-4
N° 7 (OFF)	---	-1.831E-3	-8.393E-4	-1.145E-3	-1.831E-3
N° 8 (OFF)	---	6.867E-4	8.392E-4	-7.629E-4	-3.052E-4
N° 9 (OFF)	---	-6.104E-4	9.155E-4	7.620E-5	5.340E-4
N° 10 (OFF)	---	6.104E-4	-5.340E-4	3.052E-4	-2.289E-4
N° 11 (OFF)	---	2.289E-4	1.068E-3	6.866E-4	8.392E-4
Average (ON)	---	3.509E-4	-3.200E-8	6.103E-5	-5.799E-4
s (ON)	---	8.228E-4	9.391E-4	1.111E-3	9.927E-4
Average+3s (ON)	---	2.819E-3	2.817E-3	3.395E-3	2.398E-3
Average-3s (ON)	---	-2.117E-3	-2.817E-3	-3.273E-3	-3.558E-3
Average (OFF)	---	-1.831E-4	2.899E-4	-1.679E-4	-1.984E-4
s (OFF)	---	1.055E-3	9.017E-4	7.618E-4	1.036E-3
Average+3s (OFF)	---	2.983E-3	2.995E-3	2.118E-3	2.909E-3
Average-3s (OFF)	---	-3.349E-3	-2.415E-3	-2.453E-3	-3.306E-3

15. Ilih_A[13]

Ta = 25°C, Vcc = 3.3V, Vin = Vcc

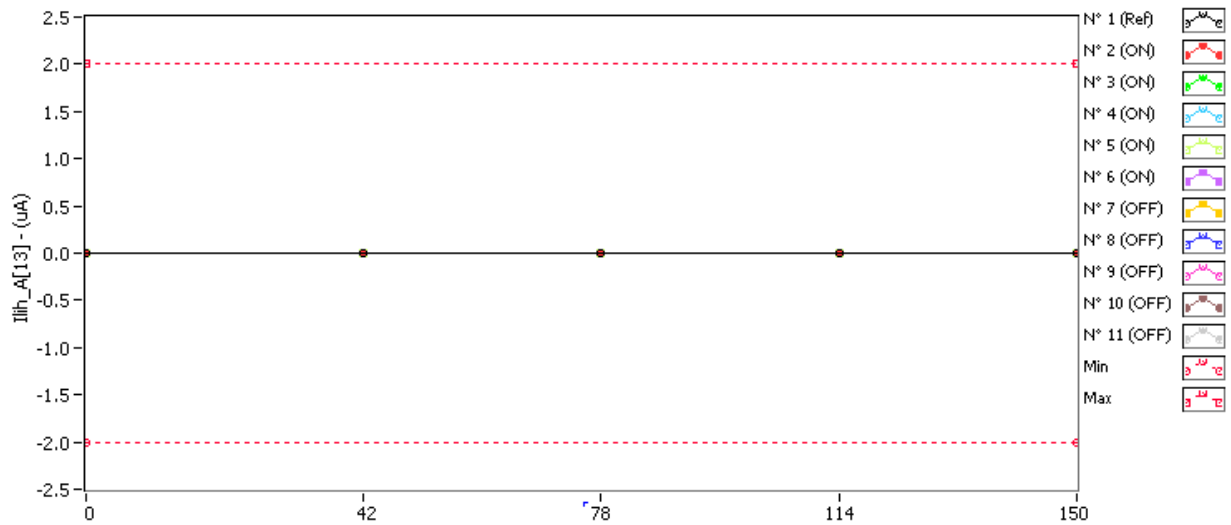

Ilih_A[13] . (uA) Min = -2.0 Max = 2.0

	0krad(Si)	42krad(Si)	78krad(Si)	114krad(Si)	150krad(Si)
N° 1 (Ref)	2.230E-3	1.772E-3	1.772E-3	1.848E-3	3.069E-3
N° 2 (ON)	2.916E-3	2.535E-3	2.077E-3	1.620E-3	3.603E-3
N° 3 (ON)	2.840E-3	2.764E-3	1.848E-3	1.620E-3	1.543E-3
N° 4 (ON)	2.382E-3	2.230E-3	2.230E-3	3.527E-3	2.001E-3
N° 5 (ON)	2.916E-3	2.535E-3	2.840E-3	1.925E-3	2.535E-3
N° 6 (ON)	3.756E-3	1.696E-3	2.611E-3	1.925E-3	1.543E-3
N° 7 (OFF)	1.772E-3	1.925E-3	2.306E-3	2.306E-3	3.451E-3
N° 8 (OFF)	3.069E-3	3.298E-3	2.840E-3	1.772E-3	1.696E-3
N° 9 (OFF)	2.916E-3	2.535E-3	2.459E-3	3.451E-3	2.154E-3
N° 10 (OFF)	1.848E-3	2.382E-3	3.145E-3	2.688E-3	1.772E-3
N° 11 (OFF)	2.840E-3	1.848E-3	3.527E-3	3.527E-3	2.459E-3

Delta [Ilih_A[13]]

	0krad(Si)	42krad(Si)	78krad(Si)	114krad(Si)	150krad(Si)
N° 1 (Ref)	---	-4.578E-4	-4.578E-4	-3.815E-4	8.392E-4
N° 2 (ON)	---	-3.815E-4	-8.392E-4	-1.297E-3	6.866E-4
N° 3 (ON)	---	-7.630E-5	-9.918E-4	-1.221E-3	-1.297E-3
N° 4 (ON)	---	-1.525E-4	-1.525E-4	1.145E-3	-3.814E-4
N° 5 (ON)	---	-3.815E-4	-7.630E-5	-9.918E-4	-3.815E-4
N° 6 (ON)	---	-2.060E-3	-1.144E-3	-1.831E-3	-2.213E-3
N° 7 (OFF)	---	1.526E-4	5.341E-4	5.341E-4	1.678E-3
N° 8 (OFF)	---	2.289E-4	-2.289E-4	-1.297E-3	-1.373E-3
N° 9 (OFF)	---	-3.815E-4	-4.578E-4	5.341E-4	-7.629E-4
N° 10 (OFF)	---	5.340E-4	1.297E-3	8.392E-4	-7.630E-5
N° 11 (OFF)	---	-9.918E-4	6.867E-4	6.867E-4	-3.815E-4
Average (ON)	---	-6.103E-4	-6.408E-4	-8.392E-4	-7.172E-4
s (ON)	---	8.217E-4	4.933E-4	1.151E-3	1.092E-3
Average+3s (ON)	---	1.855E-3	8.390E-4	2.613E-3	2.558E-3
Average-3s (ON)	---	-3.075E-3	-2.121E-3	-4.292E-3	-3.993E-3
Average (OFF)	---	-9.156E-5	3.662E-4	2.594E-4	-1.831E-4
s (OFF)	---	6.017E-4	7.125E-4	8.792E-4	1.148E-3
Average+3s (OFF)	---	1.714E-3	2.504E-3	2.897E-3	3.260E-3
Average-3s (OFF)	---	-1.897E-3	-1.771E-3	-2.378E-3	-3.626E-3

16. Ilih_A[14]

Ta = 25°C, Vcc = 3.3V, Vin = Vcc

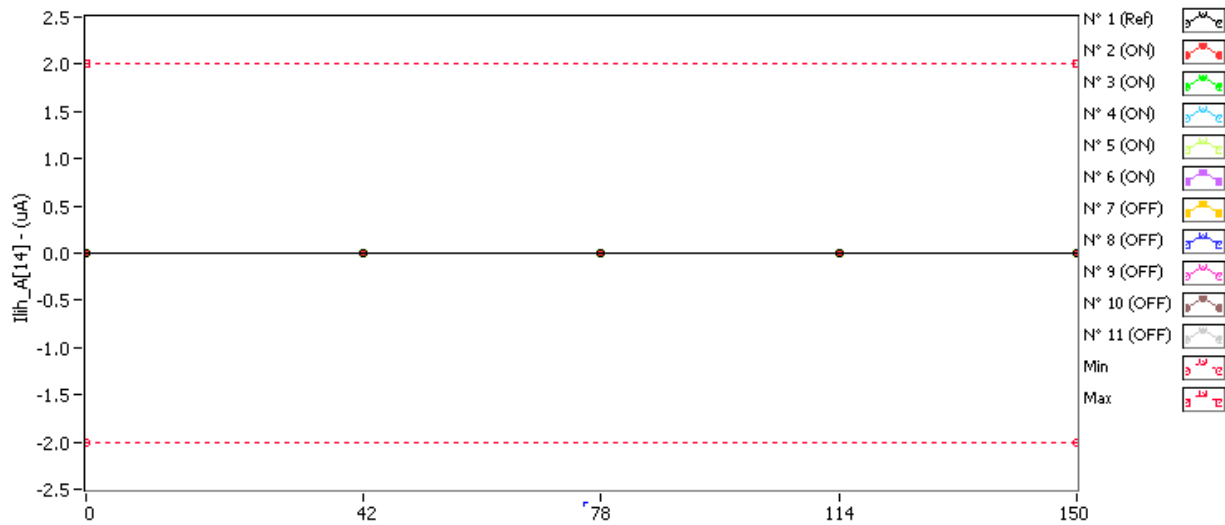

Ilih_A[14] . (uA) Min = -2.0 Max = 2.0

	0krad(Si)	42krad(Si)	78krad(Si)	114krad(Si)	150krad(Si)
N° 1 (Ref)	2.459E-3	6.277E-4	1.696E-3	2.154E-3	2.230E-3
N° 2 (ON)	1.772E-3	1.696E-3	2.382E-3	1.620E-3	2.077E-3
N° 3 (ON)	2.154E-3	2.382E-3	2.001E-3	1.696E-3	2.611E-3
N° 4 (ON)	2.688E-3	1.162E-3	1.620E-3	2.611E-3	9.329E-4
N° 5 (ON)	1.238E-3	2.764E-3	1.696E-3	1.772E-3	1.772E-3
N° 6 (ON)	1.543E-3	1.314E-3	2.611E-3	1.467E-3	2.993E-3
N° 7 (OFF)	1.238E-3	1.238E-3	2.459E-3	2.306E-3	2.306E-3
N° 8 (OFF)	1.772E-3	1.391E-3	1.620E-3	1.467E-3	1.848E-3
N° 9 (OFF)	1.085E-3	2.535E-3	1.391E-3	1.772E-3	1.391E-3
N° 10 (OFF)	7.803E-4	1.467E-3	2.688E-3	1.620E-3	2.688E-3
N° 11 (OFF)	2.306E-3	1.238E-3	1.620E-3	1.925E-3	1.620E-3

Delta [Ilih_A[14]]

	0krad(Si)	42krad(Si)	78krad(Si)	114krad(Si)	150krad(Si)
N° 1 (Ref)	---	-1.831E-3	-7.629E-4	-3.051E-4	-2.288E-4
N° 2 (ON)	---	-7.630E-5	6.103E-4	-1.526E-4	3.052E-4
N° 3 (ON)	---	2.288E-4	-1.526E-4	-4.578E-4	4.577E-4
N° 4 (ON)	---	-1.526E-3	-1.068E-3	-7.630E-5	-1.755E-3
N° 5 (ON)	---	1.526E-3	4.578E-4	5.341E-4	5.341E-4
N° 6 (ON)	---	-2.289E-4	1.068E-3	-7.630E-5	1.450E-3
N° 7 (OFF)	---	0.000E+0	1.221E-3	1.068E-3	1.068E-3
N° 8 (OFF)	---	-3.815E-4	-1.526E-4	-3.052E-4	7.630E-5
N° 9 (OFF)	---	1.450E-3	3.052E-4	6.867E-4	3.052E-4
N° 10 (OFF)	---	6.866E-4	1.907E-3	8.392E-4	1.907E-3
N° 11 (OFF)	---	-1.068E-3	-6.867E-4	-3.815E-4	-6.867E-4
Average (ON)	---	-1.528E-5	1.831E-4	-4.578E-5	1.984E-4
s (ON)	---	1.092E-3	8.245E-4	3.603E-4	1.180E-3
Average+3s (ON)	---	3.259E-3	2.657E-3	1.035E-3	3.739E-3
Average-3s (ON)	---	-3.290E-3	-2.290E-3	-1.127E-3	-3.342E-3
Average (OFF)	---	1.373E-4	5.188E-4	3.815E-4	5.341E-4
s (OFF)	---	9.702E-4	1.045E-3	6.760E-4	9.904E-4
Average+3s (OFF)	---	3.048E-3	3.655E-3	2.410E-3	3.505E-3
Average-3s (OFF)	---	-2.773E-3	-2.617E-3	-1.647E-3	-2.437E-3

17. Ilih_A[15]

Ta = 25°C, Vcc = 3.3V, Vin = Vcc

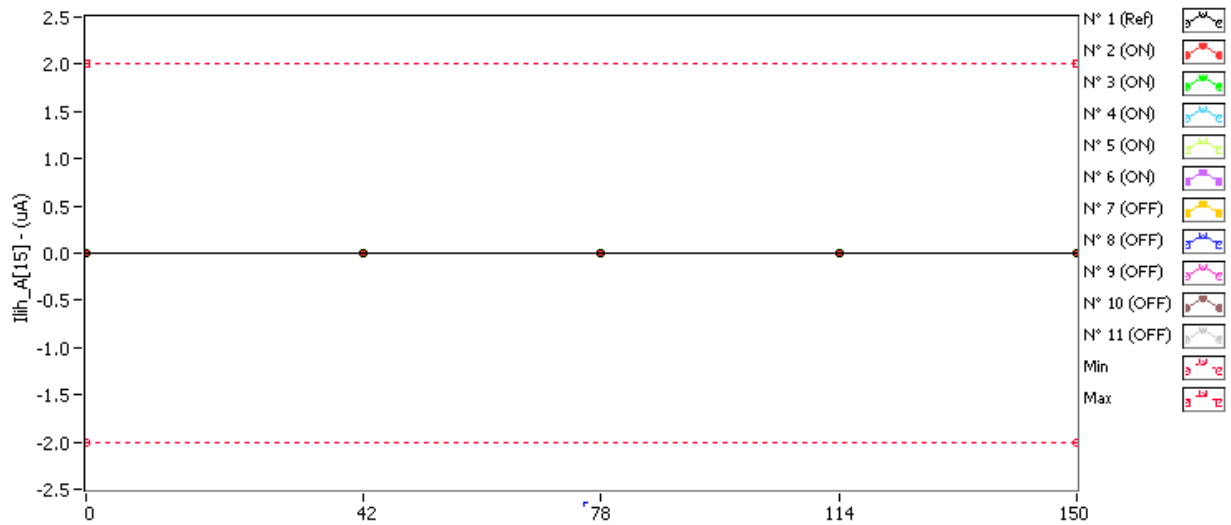

Ilih_A[15] . (uA) Min = -2.0 Max = 2.0

	0krad(Si)	42krad(Si)	78krad(Si)	114krad(Si)	150krad(Si)
N° 1 (Ref)	1.925E-3	1.391E-3	2.840E-3	3.145E-3	2.535E-3
N° 2 (ON)	2.077E-3	1.772E-3	3.222E-3	1.696E-3	3.451E-3
N° 3 (ON)	2.840E-3	2.001E-3	2.764E-3	3.451E-3	3.908E-3
N° 4 (ON)	2.459E-3	3.069E-3	2.535E-3	2.230E-3	3.374E-3
N° 5 (ON)	2.840E-3	2.916E-3	1.467E-3	2.306E-3	1.925E-3
N° 6 (ON)	2.001E-3	2.840E-3	2.001E-3	2.306E-3	2.077E-3
N° 7 (OFF)	2.230E-3	2.230E-3	2.459E-3	2.993E-3	2.001E-3
N° 8 (OFF)	2.306E-3	1.696E-3	2.993E-3	3.145E-3	2.535E-3
N° 9 (OFF)	1.696E-3	1.772E-3	3.298E-3	2.382E-3	2.077E-3
N° 10 (OFF)	2.916E-3	2.840E-3	3.451E-3	3.145E-3	1.620E-3
N° 11 (OFF)	2.840E-3	1.696E-3	3.145E-3	3.527E-3	2.077E-3

Delta [Ilih_A[15]]

	0krad(Si)	42krad(Si)	78krad(Si)	114krad(Si)	150krad(Si)
N° 1 (Ref)	---	-5.341E-4	9.155E-4	1.221E-3	6.103E-4
N° 2 (ON)	---	-3.052E-4	1.144E-3	-3.815E-4	1.373E-3
N° 3 (ON)	---	-8.392E-4	-7.630E-5	6.104E-4	1.068E-3
N° 4 (ON)	---	6.104E-4	7.630E-5	-2.288E-4	9.156E-4
N° 5 (ON)	---	7.630E-5	-1.373E-3	-5.340E-4	-9.155E-4
N° 6 (ON)	---	8.392E-4	0.000E+0	3.052E-4	7.630E-5
N° 7 (OFF)	---	0.000E+0	2.288E-4	7.629E-4	-2.289E-4
N° 8 (OFF)	---	-6.104E-4	6.866E-4	8.392E-4	2.288E-4
N° 9 (OFF)	---	7.630E-5	1.602E-3	6.866E-4	3.815E-4
N° 10 (OFF)	---	-7.630E-5	5.341E-4	2.289E-4	-1.297E-3
N° 11 (OFF)	---	-1.144E-3	3.052E-4	6.867E-4	-7.629E-4
Average (ON)	---	7.630E-5	-4.578E-5	-4.574E-5	5.036E-4
s (ON)	---	6.803E-4	8.940E-4	4.843E-4	9.275E-4
Average+3s (ON)	---	2.117E-3	2.636E-3	1.407E-3	3.286E-3
Average-3s (ON)	---	-1.964E-3	-2.728E-3	-1.499E-3	-2.279E-3
Average (OFF)	---	-3.510E-4	6.714E-4	6.409E-4	-3.357E-4
s (OFF)	---	5.191E-4	5.512E-4	2.388E-4	6.984E-4
Average+3s (OFF)	---	1.206E-3	2.325E-3	1.357E-3	1.759E-3
Average-3s (OFF)	---	-1.908E-3	-9.823E-4	-7.560E-5	-2.431E-3

18. Ilih_A[16]

Ta = 25°C, Vcc = 3.3V, Vin = Vcc

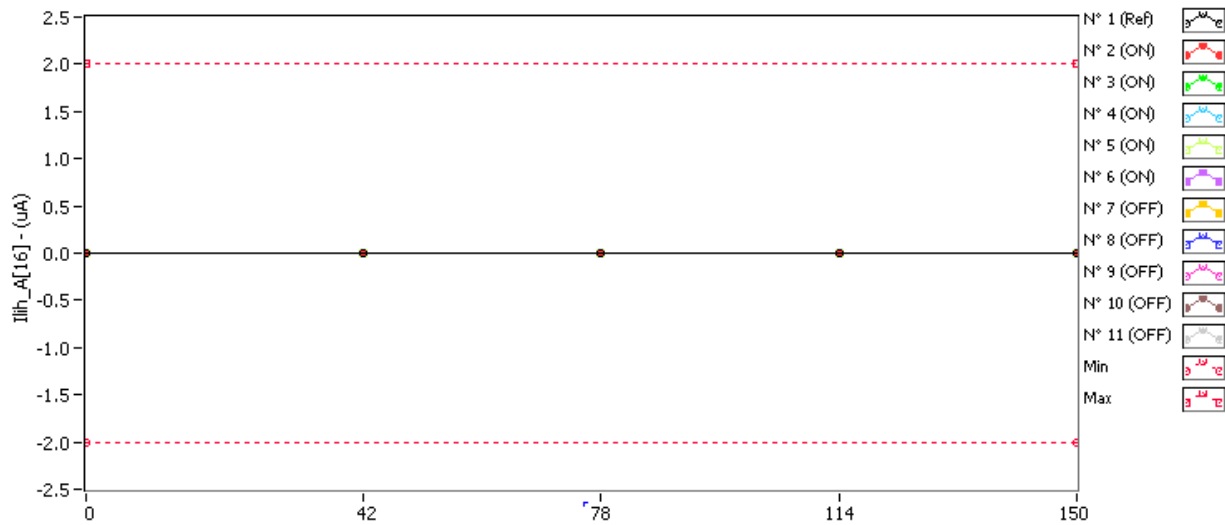

Ilih_A[16] . (uA) Min = -2.0 Max = 2.0

	0krad(Si)	42krad(Si)	78krad(Si)	114krad(Si)	150krad(Si)
N° 1 (Ref)	2.154E-3	2.077E-3	1.620E-3	2.077E-3	1.848E-3
N° 2 (ON)	2.154E-3	2.459E-3	1.772E-3	1.467E-3	1.772E-3
N° 3 (ON)	2.154E-3	2.382E-3	1.543E-3	2.840E-3	2.382E-3
N° 4 (ON)	1.162E-3	1.696E-3	1.696E-3	1.162E-3	1.696E-3
N° 5 (ON)	2.306E-3	1.620E-3	1.696E-3	2.611E-3	2.077E-3
N° 6 (ON)	2.306E-3	2.611E-3	1.620E-3	2.382E-3	1.620E-3
N° 7 (OFF)	1.085E-3	1.848E-3	2.001E-3	1.848E-3	2.077E-3
N° 8 (OFF)	2.916E-3	3.069E-3	2.154E-3	1.925E-3	2.688E-3
N° 9 (OFF)	1.772E-3	2.764E-3	2.459E-3	3.222E-3	1.620E-3
N° 10 (OFF)	1.009E-3	2.001E-3	1.848E-3	2.535E-3	1.467E-3
N° 11 (OFF)	2.535E-3	1.314E-3	2.001E-3	2.916E-3	2.459E-3

Delta [Ilih_A[16]]

	0krad(Si)	42krad(Si)	78krad(Si)	114krad(Si)	150krad(Si)
N° 1 (Ref)	---	-7.630E-5	-5.341E-4	-7.630E-5	-3.052E-4
N° 2 (ON)	---	3.051E-4	-3.815E-4	-6.867E-4	-3.815E-4
N° 3 (ON)	---	2.288E-4	-6.104E-4	6.866E-4	2.288E-4
N° 4 (ON)	---	5.341E-4	5.341E-4	0.000E+0	5.341E-4
N° 5 (ON)	---	-6.867E-4	-6.104E-4	3.051E-4	-2.289E-4
N° 6 (ON)	---	3.051E-4	-6.867E-4	7.620E-5	-6.867E-4
N° 7 (OFF)	---	7.630E-4	9.156E-4	7.630E-4	9.919E-4
N° 8 (OFF)	---	1.526E-4	-7.629E-4	-9.918E-4	-2.289E-4
N° 9 (OFF)	---	9.918E-4	6.866E-4	1.450E-3	-1.526E-4
N° 10 (OFF)	---	9.918E-4	8.392E-4	1.526E-3	4.577E-4
N° 11 (OFF)	---	-1.221E-3	-5.340E-4	3.815E-4	-7.630E-5
Average (ON)	---	1.373E-4	-3.510E-4	7.624E-5	-1.068E-4
s (ON)	---	4.746E-4	5.078E-4	5.032E-4	4.873E-4
Average+3s (ON)	---	1.561E-3	1.173E-3	1.586E-3	1.355E-3
Average-3s (ON)	---	-1.287E-3	-1.874E-3	-1.433E-3	-1.569E-3
Average (OFF)	---	3.357E-4	2.289E-4	6.256E-4	1.984E-4
s (OFF)	---	9.353E-4	8.092E-4	1.023E-3	5.192E-4
Average+3s (OFF)	---	3.142E-3	2.656E-3	3.694E-3	1.756E-3
Average-3s (OFF)	---	-2.470E-3	-2.199E-3	-2.443E-3	-1.359E-3

19. Ilih_A[17]

Ta = 25°C, Vcc = 3.3V, Vin = Vcc

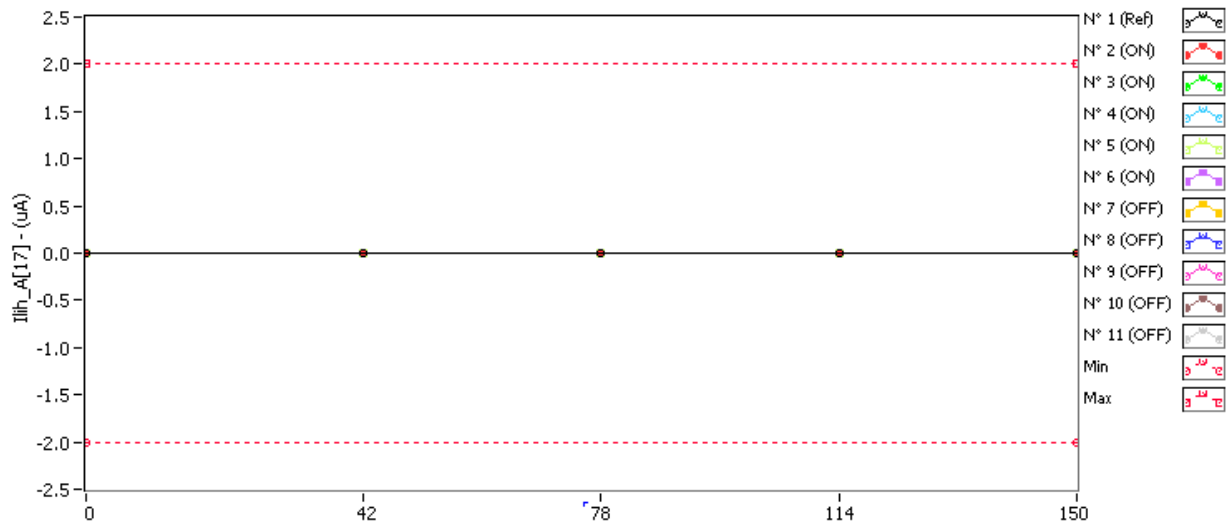

Ilih_A[17] . (uA) Min = -2.0 Max = 2.0

	0krad(Si)	42krad(Si)	78krad(Si)	114krad(Si)	150krad(Si)
N° 1 (Ref)	2.077E-3	2.077E-3	1.772E-3	2.993E-3	2.077E-3
N° 2 (ON)	3.527E-3	2.306E-3	3.603E-3	2.230E-3	2.611E-3
N° 3 (ON)	2.611E-3	3.374E-3	3.603E-3	3.222E-3	3.222E-3
N° 4 (ON)	2.916E-3	2.916E-3	2.840E-3	2.077E-3	2.688E-3
N° 5 (ON)	2.688E-3	2.916E-3	1.848E-3	2.840E-3	2.840E-3
N° 6 (ON)	3.374E-3	1.772E-3	2.001E-3	2.535E-3	2.306E-3
N° 7 (OFF)	3.069E-3	3.145E-3	3.145E-3	2.535E-3	2.764E-3
N° 8 (OFF)	2.993E-3	2.154E-3	3.679E-3	1.772E-3	2.154E-3
N° 9 (OFF)	2.916E-3	2.230E-3	2.154E-3	2.230E-3	2.306E-3
N° 10 (OFF)	3.222E-3	3.603E-3	1.925E-3	2.840E-3	2.459E-3
N° 11 (OFF)	1.696E-3	2.611E-3	2.993E-3	2.535E-3	3.527E-3

Delta [Ilih_A[17]]

	0krad(Si)	42krad(Si)	78krad(Si)	114krad(Si)	150krad(Si)
N° 1 (Ref)	---	0.000E+0	-3.052E-4	9.155E-4	0.000E+0
N° 2 (ON)	---	-1.221E-3	7.620E-5	-1.297E-3	-9.156E-4
N° 3 (ON)	---	7.630E-4	9.918E-4	6.104E-4	6.104E-4
N° 4 (ON)	---	0.000E+0	-7.630E-5	-8.392E-4	-2.289E-4
N° 5 (ON)	---	2.289E-4	-8.392E-4	1.526E-4	1.526E-4
N° 6 (ON)	---	-1.602E-3	-1.373E-3	-8.393E-4	-1.068E-3
N° 7 (OFF)	---	7.630E-5	7.630E-5	-5.341E-4	-3.052E-4
N° 8 (OFF)	---	-8.392E-4	6.866E-4	-1.221E-3	-8.392E-4
N° 9 (OFF)	---	-6.866E-4	-7.629E-4	-6.866E-4	-6.103E-4
N° 10 (OFF)	---	3.814E-4	-1.297E-3	-3.815E-4	-7.630E-4
N° 11 (OFF)	---	9.155E-4	1.297E-3	8.392E-4	1.831E-3
Average (ON)	---	-3.662E-4	-2.442E-4	-4.425E-4	-2.899E-4
s (ON)	---	1.003E-3	9.066E-4	7.918E-4	7.084E-4
Average+3s (ON)	---	2.642E-3	2.476E-3	1.933E-3	1.835E-3
Average-3s (ON)	---	-3.374E-3	-2.964E-3	-2.818E-3	-2.415E-3
Average (OFF)	---	-3.052E-5	4.337E-20	-3.967E-4	-1.373E-4
s (OFF)	---	7.349E-4	1.052E-3	7.599E-4	1.119E-3
Average+3s (OFF)	---	2.174E-3	3.155E-3	1.883E-3	3.220E-3
Average-3s (OFF)	---	-2.235E-3	-3.155E-3	-2.676E-3	-3.495E-3

20. Ilih_CS#

Ta = 25°C, Vcc = 3.3V, Vin = Vcc

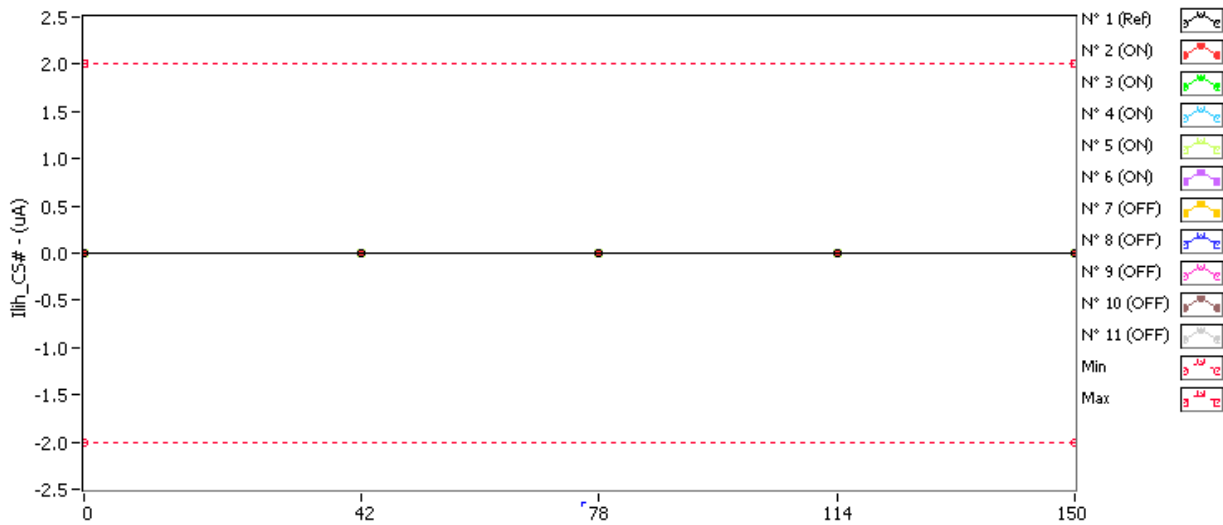

Ilih_CS# . (uA) Min = -2.0 Max = 2.0

	0krad(Si)	42krad(Si)	78krad(Si)	114krad(Si)	150krad(Si)
N° 1 (Ref)	1.162E-3	1.925E-3	2.306E-3	1.848E-3	2.306E-3
N° 2 (ON)	1.467E-3	2.916E-3	2.916E-3	3.069E-3	5.739E-3
N° 3 (ON)	2.382E-3	1.314E-3	1.162E-3	1.772E-3	4.061E-3
N° 4 (ON)	2.916E-3	2.077E-3	2.764E-3	2.993E-3	3.298E-3
N° 5 (ON)	1.391E-3	1.696E-3	2.230E-3	1.314E-3	4.366E-3
N° 6 (ON)	2.840E-3	2.154E-3	2.001E-3	3.145E-3	1.772E-3
N° 7 (OFF)	1.696E-3	1.238E-3	2.688E-3	2.993E-3	1.620E-3
N° 8 (OFF)	2.230E-3	1.696E-3	1.391E-3	1.925E-3	2.077E-3
N° 9 (OFF)	2.154E-3	2.459E-3	1.238E-3	2.916E-3	2.306E-3
N° 10 (OFF)	1.238E-3	2.382E-3	2.382E-3	1.848E-3	3.145E-3
N° 11 (OFF)	1.772E-3	2.306E-3	1.391E-3	2.916E-3	2.535E-3

Delta [Ilih_CS#]

	0krad(Si)	42krad(Si)	78krad(Si)	114krad(Si)	150krad(Si)
N° 1 (Ref)	---	7.630E-4	1.144E-3	6.867E-4	1.144E-3
N° 2 (ON)	---	1.450E-3	1.450E-3	1.602E-3	4.273E-3
N° 3 (ON)	---	-1.068E-3	-1.221E-3	-6.103E-4	1.679E-3
N° 4 (ON)	---	-8.392E-4	-1.526E-4	7.630E-5	3.815E-4
N° 5 (ON)	---	3.052E-4	8.393E-4	-7.630E-5	2.976E-3
N° 6 (ON)	---	-6.866E-4	-8.392E-4	3.052E-4	-1.068E-3
N° 7 (OFF)	---	-4.578E-4	9.918E-4	1.297E-3	-7.630E-5
N° 8 (OFF)	---	-5.341E-4	-8.393E-4	-3.052E-4	-1.526E-4
N° 9 (OFF)	---	3.051E-4	-9.156E-4	7.629E-4	1.526E-4
N° 10 (OFF)	---	1.144E-3	1.144E-3	6.104E-4	1.907E-3
N° 11 (OFF)	---	5.341E-4	-3.815E-4	1.144E-3	7.629E-4
Average (ON)	---	-1.678E-4	1.528E-5	2.594E-4	1.648E-3
s (ON)	---	1.045E-3	1.121E-3	8.228E-4	2.100E-3
Average+3s (ON)	---	2.968E-3	3.377E-3	2.728E-3	7.947E-3
Average-3s (ON)	---	-3.304E-3	-3.346E-3	-2.209E-3	-4.651E-3
Average (OFF)	---	1.983E-4	-4.000E-8	7.019E-4	5.188E-4
s (OFF)	---	7.047E-4	9.977E-4	6.278E-4	8.554E-4
Average+3s (OFF)	---	2.312E-3	2.993E-3	2.585E-3	3.085E-3
Average-3s (OFF)	---	-1.916E-3	-2.993E-3	-1.181E-3	-2.047E-3

21. Ilih_OE#

Ta = 25°C, Vcc = 3.3V, Vin = Vcc

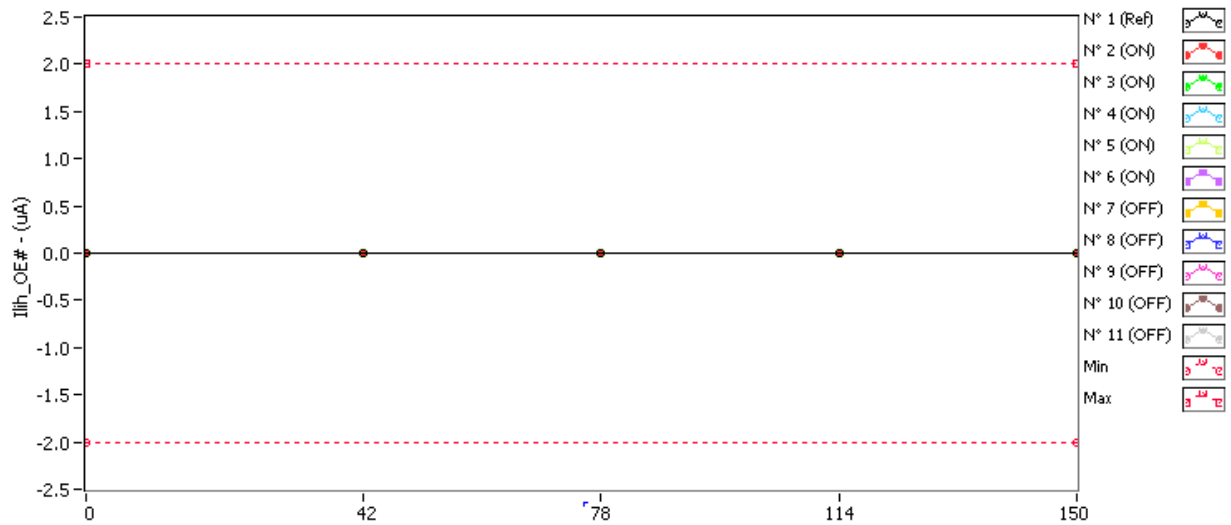

Ilih_OE# . (uA) Min = -2.0 Max = 2.0

	0krad(Si)	42krad(Si)	78krad(Si)	114krad(Si)	150krad(Si)
N° 1 (Ref)	2.001E-3	1.848E-3	1.848E-3	2.459E-3	2.611E-3
N° 2 (ON)	1.696E-3	2.459E-3	2.077E-3	2.230E-3	3.145E-3
N° 3 (ON)	2.764E-3	2.001E-3	2.840E-3	2.535E-3	2.840E-3
N° 4 (ON)	2.230E-3	2.764E-3	2.840E-3	2.077E-3	2.077E-3
N° 5 (ON)	1.848E-3	1.391E-3	1.543E-3	2.459E-3	1.848E-3
N° 6 (ON)	2.611E-3	1.543E-3	3.222E-3	1.696E-3	1.772E-3
N° 7 (OFF)	1.848E-3	1.848E-3	2.688E-3	2.230E-3	2.001E-3
N° 8 (OFF)	1.696E-3	3.374E-3	1.696E-3	2.459E-3	1.848E-3
N° 9 (OFF)	2.306E-3	2.764E-3	2.840E-3	2.688E-3	2.688E-3
N° 10 (OFF)	1.467E-3	2.688E-3	2.535E-3	2.688E-3	2.535E-3
N° 11 (OFF)	2.840E-3	1.543E-3	3.222E-3	1.620E-3	1.925E-3

Delta [Ilih_OE#]

	0krad(Si)	42krad(Si)	78krad(Si)	114krad(Si)	150krad(Si)
N° 1 (Ref)	---	-1.526E-4	-1.526E-4	4.577E-4	6.103E-4
N° 2 (ON)	---	7.629E-4	3.815E-4	5.341E-4	1.450E-3
N° 3 (ON)	---	-7.629E-4	7.630E-5	-2.289E-4	7.630E-5
N° 4 (ON)	---	5.340E-4	6.103E-4	-1.526E-4	-1.526E-4
N° 5 (ON)	---	-4.578E-4	-3.052E-4	6.103E-4	0.000E+0
N° 6 (ON)	---	-1.068E-3	6.104E-4	-9.155E-4	-8.392E-4
N° 7 (OFF)	---	0.000E+0	8.392E-4	3.815E-4	1.526E-4
N° 8 (OFF)	---	1.679E-3	0.000E+0	7.629E-4	1.526E-4
N° 9 (OFF)	---	4.577E-4	5.340E-4	3.814E-4	3.814E-4
N° 10 (OFF)	---	1.221E-3	1.068E-3	1.221E-3	1.068E-3
N° 11 (OFF)	---	-1.297E-3	3.815E-4	-1.221E-3	-9.155E-4
Average (ON)	---	-1.984E-4	2.747E-4	-3.052E-5	1.068E-4
s (ON)	---	8.067E-4	3.913E-4	6.259E-4	8.333E-4
Average+3s (ON)	---	2.222E-3	1.448E-3	1.847E-3	2.607E-3
Average-3s (ON)	---	-2.618E-3	-8.992E-4	-1.908E-3	-2.393E-3
Average (OFF)	---	4.120E-4	5.646E-4	3.052E-4	1.678E-4
s (OFF)	---	1.157E-3	4.130E-4	9.203E-4	7.124E-4
Average+3s (OFF)	---	3.882E-3	1.803E-3	3.066E-3	2.305E-3
Average-3s (OFF)	---	-3.058E-3	-6.743E-4	-2.456E-3	-1.969E-3

22. Ilih_UB#

Ta = 25°C, Vcc = 3.3V, Vin = Vcc

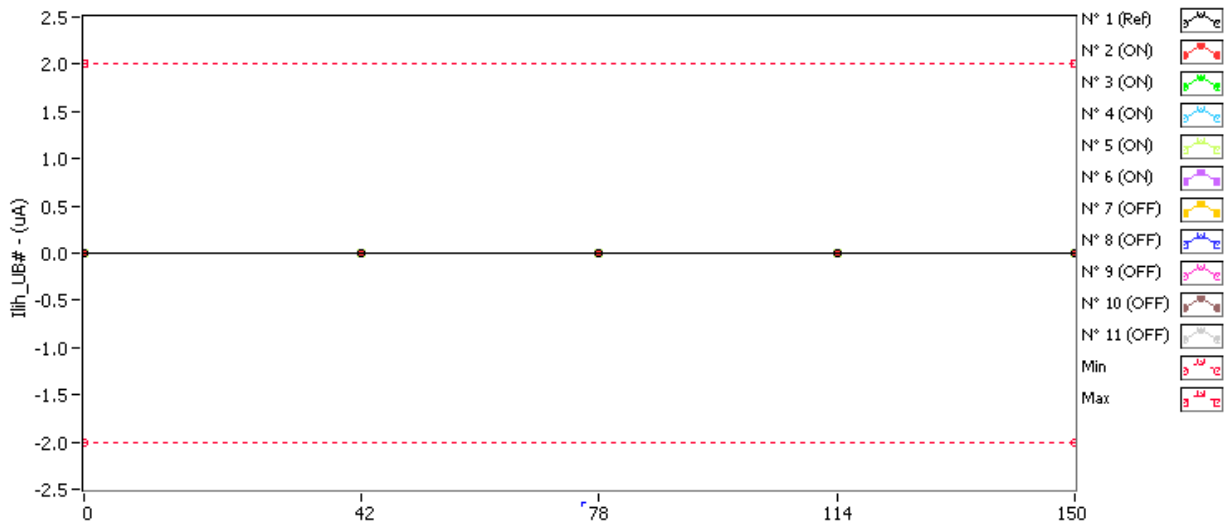

Ilih_UB# . (uA) Min = -2.0 Max = 2.0

	0krad(Si)	42krad(Si)	78krad(Si)	114krad(Si)	150krad(Si)
N° 1 (Ref)	1.925E-3	1.391E-3	1.848E-3	1.772E-3	1.238E-3
N° 2 (ON)	1.543E-3	2.916E-3	1.848E-3	1.543E-3	3.069E-3
N° 3 (ON)	2.764E-3	1.162E-3	2.840E-3	1.314E-3	1.314E-3
N° 4 (ON)	2.688E-3	2.764E-3	3.069E-3	2.764E-3	2.840E-3
N° 5 (ON)	1.238E-3	2.764E-3	1.314E-3	1.467E-3	1.772E-3
N° 6 (ON)	2.077E-3	2.459E-3	2.993E-3	3.145E-3	2.382E-3
N° 7 (OFF)	1.772E-3	3.222E-3	1.543E-3	2.230E-3	1.925E-3
N° 8 (OFF)	3.222E-3	1.620E-3	1.696E-3	2.459E-3	1.848E-3
N° 9 (OFF)	1.467E-3	2.001E-3	2.840E-3	2.916E-3	2.230E-3
N° 10 (OFF)	1.620E-3	2.611E-3	2.993E-3	2.306E-3	2.382E-3
N° 11 (OFF)	1.848E-3	2.611E-3	1.467E-3	2.916E-3	2.077E-3

Delta [Ilih_UB#]

	0krad(Si)	42krad(Si)	78krad(Si)	114krad(Si)	150krad(Si)
N° 1 (Ref)	---	-5.341E-4	-7.630E-5	-1.526E-4	-6.867E-4
N° 2 (ON)	---	1.373E-3	3.052E-4	0.000E+0	1.526E-3
N° 3 (ON)	---	-1.602E-3	7.630E-5	-1.450E-3	-1.450E-3
N° 4 (ON)	---	7.630E-5	3.815E-4	7.630E-5	1.526E-4
N° 5 (ON)	---	1.526E-3	7.630E-5	2.289E-4	5.341E-4
N° 6 (ON)	---	3.814E-4	9.155E-4	1.068E-3	3.051E-4
N° 7 (OFF)	---	1.450E-3	-2.289E-4	4.578E-4	1.526E-4
N° 8 (OFF)	---	-1.602E-3	-1.526E-3	-7.630E-4	-1.373E-3
N° 9 (OFF)	---	5.341E-4	1.373E-3	1.450E-3	7.630E-4
N° 10 (OFF)	---	9.918E-4	1.373E-3	6.867E-4	7.629E-4
N° 11 (OFF)	---	7.629E-4	-3.815E-4	1.068E-3	2.289E-4
Average (ON)	---	3.509E-4	3.510E-4	-1.526E-5	2.136E-4
s (ON)	---	1.257E-3	3.437E-4	9.082E-4	1.073E-3
Average+3s (ON)	---	4.121E-3	1.382E-3	2.709E-3	3.432E-3
Average-3s (ON)	---	-3.419E-3	-6.802E-4	-2.740E-3	-3.005E-3
Average (OFF)	---	4.272E-4	1.221E-4	5.798E-4	1.068E-4
s (OFF)	---	1.184E-3	1.247E-3	8.403E-4	8.759E-4
Average+3s (OFF)	---	3.979E-3	3.864E-3	3.101E-3	2.735E-3
Average-3s (OFF)	---	-3.125E-3	-3.620E-3	-1.941E-3	-2.521E-3

23. Ilih_LB#

Ta = 25°C, Vcc = 3.3V, Vin = Vcc

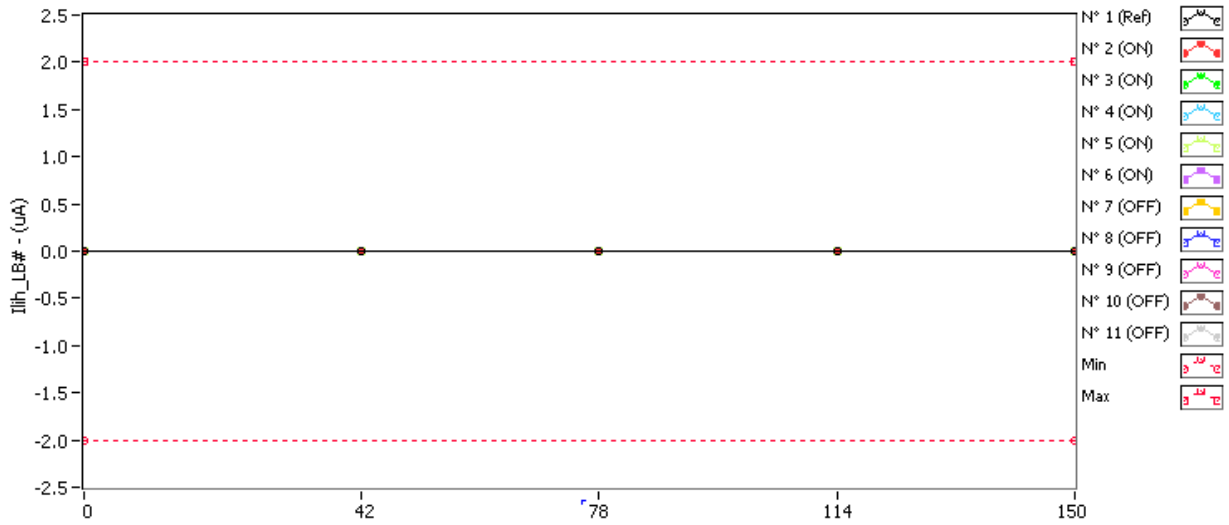

Ilih_LB# . (uA) Min = -2.0 Max = 2.0

	0krad(Si)	42krad(Si)	78krad(Si)	114krad(Si)	150krad(Si)
N° 1 (Ref)	2.993E-3	2.077E-3	1.009E-3	3.145E-3	2.382E-3
N° 2 (ON)	1.772E-3	1.772E-3	2.306E-3	2.001E-3	2.154E-3
N° 3 (ON)	1.848E-3	2.840E-3	2.840E-3	1.391E-3	3.069E-3
N° 4 (ON)	1.314E-3	1.848E-3	2.688E-3	2.688E-3	2.459E-3
N° 5 (ON)	1.467E-3	2.764E-3	2.993E-3	2.154E-3	2.611E-3
N° 6 (ON)	2.611E-3	1.162E-3	1.772E-3	1.925E-3	2.688E-3
N° 7 (OFF)	2.764E-3	2.154E-3	2.840E-3	1.772E-3	3.145E-3
N° 8 (OFF)	2.993E-3	1.543E-3	2.688E-3	1.925E-3	2.306E-3
N° 9 (OFF)	2.230E-3	1.772E-3	1.848E-3	2.764E-3	2.688E-3
N° 10 (OFF)	2.764E-3	2.382E-3	2.001E-3	2.154E-3	2.459E-3
N° 11 (OFF)	2.993E-3	2.077E-3	2.459E-3	2.916E-3	2.993E-3

Delta [Ilih_LB#]

	0krad(Si)	42krad(Si)	78krad(Si)	114krad(Si)	150krad(Si)
N° 1 (Ref)	---	-9.155E-4	-1.984E-3	1.526E-4	-6.104E-4
N° 2 (ON)	---	0.000E+0	5.341E-4	2.289E-4	3.815E-4
N° 3 (ON)	---	9.918E-4	9.918E-4	-4.578E-4	1.221E-3
N° 4 (ON)	---	5.341E-4	1.373E-3	1.373E-3	1.144E-3
N° 5 (ON)	---	1.297E-3	1.526E-3	6.867E-4	1.144E-3
N° 6 (ON)	---	-1.450E-3	-8.392E-4	-6.866E-4	7.630E-5
N° 7 (OFF)	---	-6.103E-4	7.630E-5	-9.918E-4	3.815E-4
N° 8 (OFF)	---	-1.450E-3	-3.052E-4	-1.068E-3	-6.866E-4
N° 9 (OFF)	---	-4.578E-4	-3.815E-4	5.340E-4	4.577E-4
N° 10 (OFF)	---	-3.815E-4	-7.629E-4	-6.103E-4	-3.052E-4
N° 11 (OFF)	---	-9.155E-4	-5.341E-4	-7.630E-5	0.000E+0
Average (ON)	---	2.747E-4	7.172E-4	2.289E-4	7.935E-4
s (ON)	---	1.081E-3	9.508E-4	8.410E-4	5.275E-4
Average+3s (ON)	---	3.518E-3	3.569E-3	2.752E-3	2.376E-3
Average-3s (ON)	---	-2.969E-3	-2.135E-3	-2.294E-3	-7.889E-4
Average (OFF)	---	-7.629E-4	-3.815E-4	-4.425E-4	-3.052E-5
s (OFF)	---	4.349E-4	3.099E-4	6.725E-4	4.783E-4
Average+3s (OFF)	---	5.419E-4	5.482E-4	1.575E-3	1.404E-3
Average-3s (OFF)	---	-2.068E-3	-1.311E-3	-2.460E-3	-1.465E-3

24. Ilii_WE#

Ta = 25°C, Vcc = 3.3V, Vin = 0V

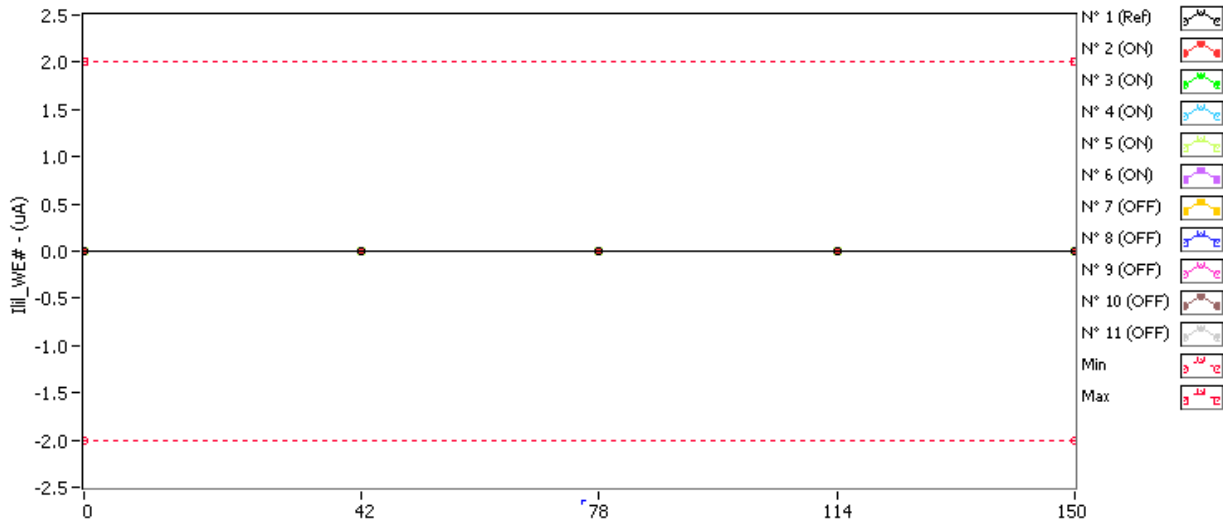

Ilii_WE# . (uA) Min = -2.0 Max = 2.0

	0krad(Si)	42krad(Si)	78krad(Si)	114krad(Si)	150krad(Si)
N° 1 (Ref)	1.543E-3	1.009E-3	1.085E-3	1.620E-3	9.329E-4
N° 2 (ON)	2.459E-3	6.277E-4	1.009E-3	1.314E-3	-2.500E-3
N° 3 (ON)	1.467E-3	2.306E-3	2.154E-3	1.085E-3	-3.569E-3
N° 4 (ON)	1.162E-3	4.751E-4	2.230E-3	9.363E-5	-4.408E-3
N° 5 (ON)	1.238E-3	1.848E-3	8.566E-4	8.566E-4	-2.805E-3
N° 6 (ON)	2.154E-3	1.925E-3	1.238E-3	2.459E-3	9.363E-5
N° 7 (OFF)	2.382E-3	1.238E-3	2.077E-3	7.040E-4	2.306E-3
N° 8 (OFF)	1.009E-3	2.535E-3	2.077E-3	3.988E-4	1.314E-3
N° 9 (OFF)	7.040E-4	1.085E-3	1.085E-3	1.848E-3	1.696E-3
N° 10 (OFF)	2.154E-3	9.329E-4	6.277E-4	2.230E-3	2.459E-3
N° 11 (OFF)	7.040E-4	6.277E-4	5.514E-4	1.391E-3	2.001E-3

Delta [Ilii_WE#]

	0krad(Si)	42krad(Si)	78krad(Si)	114krad(Si)	150krad(Si)
N° 1 (Ref)	---	-5.340E-4	-4.578E-4	7.630E-5	-6.103E-4
N° 2 (ON)	---	-1.831E-3	-1.449E-3	-1.144E-3	-4.959E-3
N° 3 (ON)	---	8.393E-4	6.867E-4	-3.815E-4	-5.035E-3
N° 4 (ON)	---	-6.866E-4	1.068E-3	-1.068E-3	-5.569E-3
N° 5 (ON)	---	6.104E-4	-3.814E-4	-3.814E-4	-4.044E-3
N° 6 (ON)	---	-2.289E-4	-9.156E-4	3.051E-4	-2.060E-3
N° 7 (OFF)	---	-1.144E-3	-3.051E-4	-1.678E-3	-7.620E-5
N° 8 (OFF)	---	1.526E-3	1.068E-3	-6.104E-4	3.051E-4
N° 9 (OFF)	---	3.814E-4	3.814E-4	1.144E-3	9.918E-4
N° 10 (OFF)	---	-1.221E-3	-1.526E-3	7.630E-5	3.051E-4
N° 11 (OFF)	---	-7.629E-5	-1.526E-4	6.866E-4	1.297E-3
Average (ON)	---	-2.594E-4	-1.983E-4	-5.341E-4	-4.333E-3
s (ON)	---	1.074E-3	1.061E-3	5.934E-4	1.384E-3
Average+3s (ON)	---	2.964E-3	2.984E-3	1.246E-3	-1.807E-4
Average-3s (ON)	---	-3.482E-3	-3.381E-3	-2.314E-3	-8.486E-3
Average (OFF)	---	-1.068E-4	-1.068E-4	-7.630E-5	5.646E-4
s (OFF)	---	1.143E-3	9.584E-4	1.112E-3	5.622E-4
Average+3s (OFF)	---	3.321E-3	2.768E-3	3.260E-3	2.251E-3
Average-3s (OFF)	---	-3.535E-3	-2.982E-3	-3.413E-3	-1.122E-3

25. IliI_A[0]

Ta = 25°C, Vcc = 3.3V, Vin = 0V

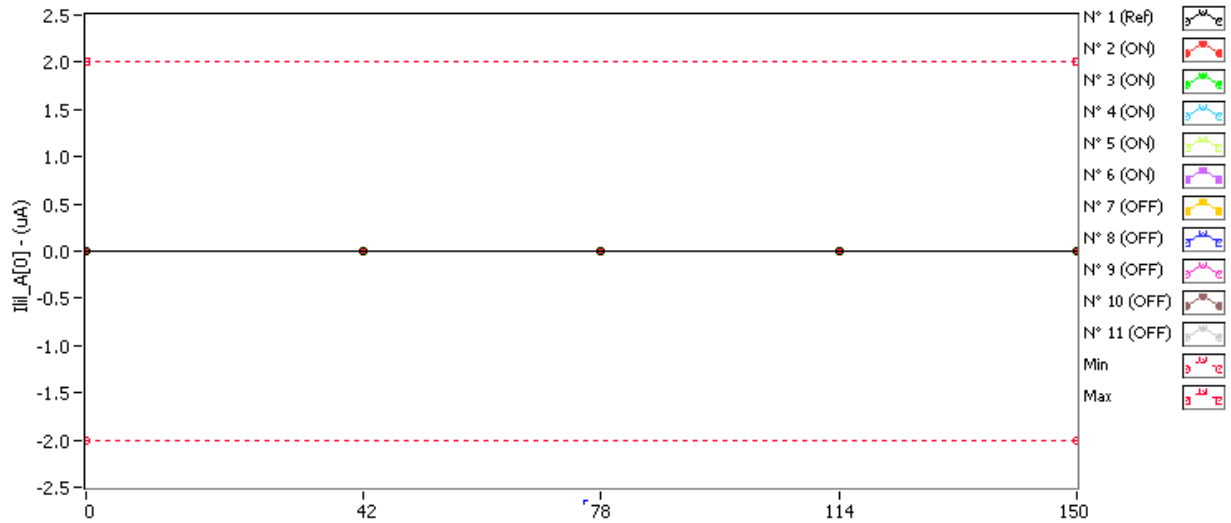

IliI_A[0] . (uA) Min = -2.0 Max = 2.0

	0krad(Si)	42krad(Si)	78krad(Si)	114krad(Si)	150krad(Si)
N° 1 (Ref)	1.772E-3	2.535E-3	1.238E-3	2.535E-3	1.543E-3
N° 2 (ON)	1.543E-3	2.611E-3	1.848E-3	1.772E-3	2.382E-3
N° 3 (ON)	2.154E-3	1.848E-3	2.688E-3	1.772E-3	1.620E-3
N° 4 (ON)	2.001E-3	3.451E-3	1.925E-3	1.925E-3	2.535E-3
N° 5 (ON)	2.916E-3	2.840E-3	2.535E-3	1.467E-3	2.688E-3
N° 6 (ON)	1.009E-3	2.382E-3	2.688E-3	2.001E-3	3.222E-3
N° 7 (OFF)	1.696E-3	3.527E-3	1.314E-3	1.848E-3	2.535E-3
N° 8 (OFF)	3.069E-3	3.374E-3	2.916E-3	2.382E-3	3.222E-3
N° 9 (OFF)	1.009E-3	2.382E-3	1.391E-3	2.077E-3	2.993E-3
N° 10 (OFF)	2.077E-3	2.764E-3	3.069E-3	3.298E-3	1.467E-3
N° 11 (OFF)	1.696E-3	2.306E-3	3.298E-3	2.611E-3	7.040E-4

Delta [IliI_A[0]]

	0krad(Si)	42krad(Si)	78krad(Si)	114krad(Si)	150krad(Si)
N° 1 (Ref)	---	7.629E-4	-5.341E-4	7.629E-4	-2.289E-4
N° 2 (ON)	---	1.068E-3	3.052E-4	2.289E-4	8.392E-4
N° 3 (ON)	---	-3.052E-4	5.340E-4	-3.815E-4	-5.341E-4
N° 4 (ON)	---	1.450E-3	-7.630E-5	-7.630E-5	5.340E-4
N° 5 (ON)	---	-7.630E-5	-3.815E-4	-1.450E-3	-2.289E-4
N° 6 (ON)	---	1.373E-3	1.678E-3	9.918E-4	2.213E-3
N° 7 (OFF)	---	1.831E-3	-3.815E-4	1.526E-4	8.392E-4
N° 8 (OFF)	---	3.052E-4	-1.526E-4	-6.867E-4	1.526E-4
N° 9 (OFF)	---	1.373E-3	3.814E-4	1.068E-3	1.984E-3
N° 10 (OFF)	---	6.866E-4	9.918E-4	1.221E-3	-6.104E-4
N° 11 (OFF)	---	6.104E-4	1.602E-3	9.155E-4	-9.918E-4
Average (ON)	---	7.019E-4	4.120E-4	-1.373E-4	5.645E-4
s (ON)	---	8.312E-4	7.903E-4	8.937E-4	1.076E-3
Average+3s (ON)	---	3.196E-3	2.783E-3	2.544E-3	3.792E-3
Average-3s (ON)	---	-1.792E-3	-1.959E-3	-2.818E-3	-2.663E-3
Average (OFF)	---	9.613E-4	4.883E-4	5.340E-4	2.746E-4
s (OFF)	---	6.236E-4	8.175E-4	7.965E-4	1.188E-3
Average+3s (OFF)	---	2.832E-3	2.941E-3	2.924E-3	3.837E-3
Average-3s (OFF)	---	-9.094E-4	-1.964E-3	-1.856E-3	-3.288E-3

26. Ilii_A[1]

Ta = 25°C, Vcc = 3.3V, Vin = 0V

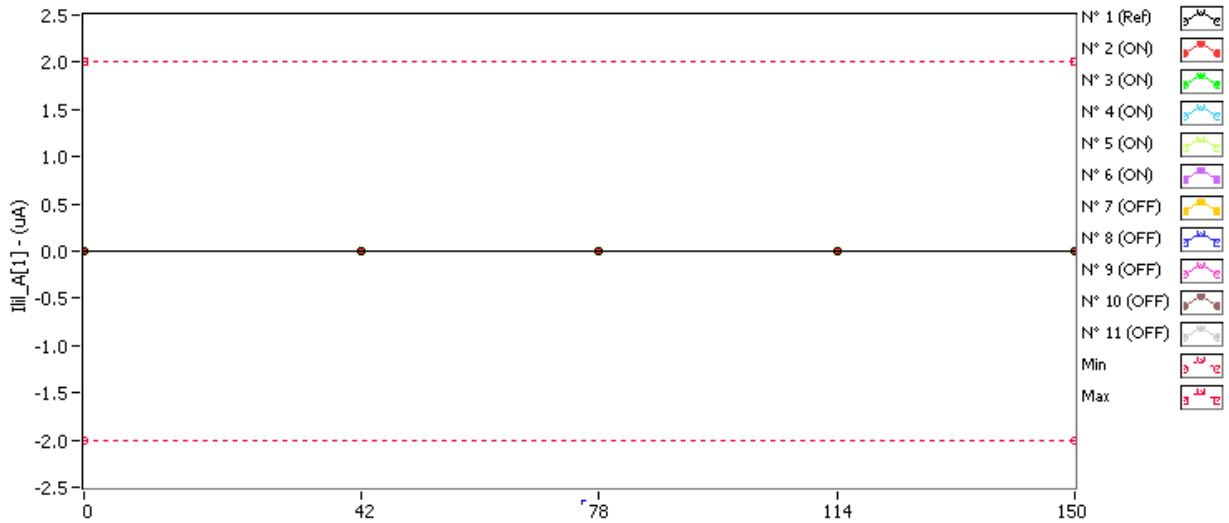

Ilii_A[1] . (uA) Min = -2.0 Max = 2.0

	0krad(Si)	42krad(Si)	78krad(Si)	114krad(Si)	150krad(Si)
N° 1 (Ref)	1.620E-3	1.085E-3	2.230E-3	2.462E-4	2.001E-3
N° 2 (ON)	1.467E-3	3.225E-4	1.620E-3	1.848E-3	1.314E-3
N° 3 (ON)	2.001E-3	5.514E-4	7.040E-4	1.848E-3	1.162E-3
N° 4 (ON)	1.162E-3	2.154E-3	1.699E-4	1.772E-3	1.009E-3
N° 5 (ON)	2.306E-3	1.085E-3	8.566E-4	4.751E-4	2.535E-3
N° 6 (ON)	2.001E-3	7.040E-4	9.363E-5	1.696E-3	4.751E-4
N° 7 (OFF)	1.009E-3	1.925E-3	1.314E-3	1.925E-3	1.009E-3
N° 8 (OFF)	1.162E-3	7.040E-4	4.751E-4	7.803E-4	2.611E-3
N° 9 (OFF)	2.764E-3	1.543E-3	1.620E-3	2.077E-3	2.154E-3
N° 10 (OFF)	2.535E-3	2.306E-3	7.040E-4	9.329E-4	9.329E-4
N° 11 (OFF)	2.306E-3	2.230E-3	3.225E-4	4.751E-4	1.848E-3

Delta [Ilii_A[1]]

	0krad(Si)	42krad(Si)	78krad(Si)	114krad(Si)	150krad(Si)
N° 1 (Ref)	---	-5.341E-4	6.104E-4	-1.373E-3	3.815E-4
N° 2 (ON)	---	-1.144E-3	1.526E-4	3.815E-4	-1.526E-4
N° 3 (ON)	---	-1.450E-3	-1.297E-3	-1.526E-4	-8.393E-4
N° 4 (ON)	---	9.919E-4	-9.918E-4	6.104E-4	-1.525E-4
N° 5 (ON)	---	-1.221E-3	-1.450E-3	-1.831E-3	2.288E-4
N° 6 (ON)	---	-1.297E-3	-1.907E-3	-3.052E-4	-1.526E-3
N° 7 (OFF)	---	9.155E-4	3.051E-4	9.155E-4	0.000E+0
N° 8 (OFF)	---	-4.577E-4	-6.866E-4	-3.814E-4	1.450E-3
N° 9 (OFF)	---	-1.221E-3	-1.144E-3	-6.866E-4	-6.103E-4
N° 10 (OFF)	---	-2.288E-4	-1.831E-3	-1.602E-3	-1.602E-3
N° 11 (OFF)	---	-7.630E-5	-1.984E-3	-1.831E-3	-4.578E-4
Average (ON)	---	-8.240E-4	-1.099E-3	-2.594E-4	-4.883E-4
s (ON)	---	1.021E-3	7.736E-4	9.554E-4	6.963E-4
Average+3s (ON)	---	2.240E-3	1.222E-3	2.607E-3	1.601E-3
Average-3s (ON)	---	-3.888E-3	-3.419E-3	-3.126E-3	-2.577E-3
Average (OFF)	---	-2.136E-4	-1.068E-3	-7.172E-4	-2.441E-4
s (OFF)	---	7.694E-4	9.297E-4	1.096E-3	1.113E-3
Average+3s (OFF)	---	2.095E-3	1.721E-3	2.570E-3	3.094E-3
Average-3s (OFF)	---	-2.522E-3	-3.857E-3	-4.005E-3	-3.582E-3

27. Ilii_A[2]

Ta = 25°C, Vcc = 3.3V, Vin = 0V

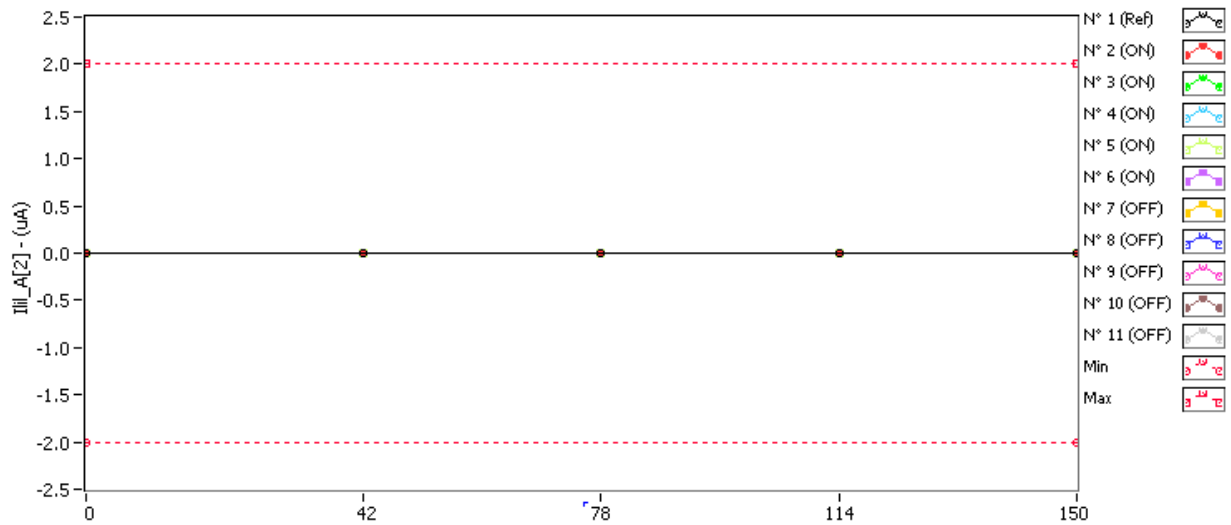

Ilii_A[2] . (uA) Min = -2.0 Max = 2.0

	0krad(Si)	42krad(Si)	78krad(Si)	114krad(Si)	150krad(Si)
N° 1 (Ref)	1.238E-3	9.329E-4	1.467E-3	2.077E-3	6.277E-4
N° 2 (ON)	7.040E-4	2.001E-3	1.772E-3	2.764E-3	1.543E-3
N° 3 (ON)	8.566E-4	2.840E-3	1.162E-3	1.162E-3	1.696E-3
N° 4 (ON)	1.543E-3	1.391E-3	2.077E-3	2.611E-3	2.382E-3
N° 5 (ON)	2.764E-3	2.688E-3	1.085E-3	6.277E-4	9.329E-4
N° 6 (ON)	1.085E-3	2.535E-3	2.611E-3	1.391E-3	1.314E-3
N° 7 (OFF)	5.514E-4	1.696E-3	1.467E-3	1.543E-3	2.764E-3
N° 8 (OFF)	2.611E-3	2.001E-3	1.009E-3	1.925E-3	2.611E-3
N° 9 (OFF)	2.764E-3	1.543E-3	1.238E-3	1.925E-3	1.009E-3
N° 10 (OFF)	1.162E-3	4.751E-4	2.764E-3	2.840E-3	1.162E-3
N° 11 (OFF)	2.077E-3	9.329E-4	2.916E-3	2.306E-3	1.543E-3

Delta [Ilii_A[2]]

	0krad(Si)	42krad(Si)	78krad(Si)	114krad(Si)	150krad(Si)
N° 1 (Ref)	---	-3.051E-4	2.289E-4	8.393E-4	-6.103E-4
N° 2 (ON)	---	1.297E-3	1.068E-3	2.060E-3	8.392E-4
N° 3 (ON)	---	1.984E-3	3.051E-4	3.051E-4	8.392E-4
N° 4 (ON)	---	-1.526E-4	5.341E-4	1.068E-3	8.392E-4
N° 5 (ON)	---	-7.630E-5	-1.679E-3	-2.136E-3	-1.831E-3
N° 6 (ON)	---	1.450E-3	1.526E-3	3.052E-4	2.289E-4
N° 7 (OFF)	---	1.144E-3	9.155E-4	9.918E-4	2.213E-3
N° 8 (OFF)	---	-6.103E-4	-1.602E-3	-6.866E-4	0.000E+0
N° 9 (OFF)	---	-1.221E-3	-1.526E-3	-8.392E-4	-1.755E-3
N° 10 (OFF)	---	-6.866E-4	1.602E-3	1.679E-3	0.000E+0
N° 11 (OFF)	---	-1.144E-3	8.392E-4	2.289E-4	-5.341E-4
Average (ON)	---	9.003E-4	3.509E-4	3.204E-4	1.831E-4
s (ON)	---	9.611E-4	1.230E-3	1.551E-3	1.157E-3
Average+3s (ON)	---	3.784E-3	4.040E-3	4.973E-3	3.653E-3
Average-3s (ON)	---	-1.983E-3	-3.338E-3	-4.332E-3	-3.287E-3
Average (OFF)	---	-5.035E-4	4.578E-5	2.747E-4	-1.526E-5
s (OFF)	---	9.599E-4	1.500E-3	1.078E-3	1.437E-3
Average+3s (OFF)	---	2.376E-3	4.544E-3	3.510E-3	4.295E-3
Average-3s (OFF)	---	-3.383E-3	-4.453E-3	-2.961E-3	-4.326E-3

28. IliI_A[3]

Ta = 25°C, Vcc = 3.3V, Vin = 0V

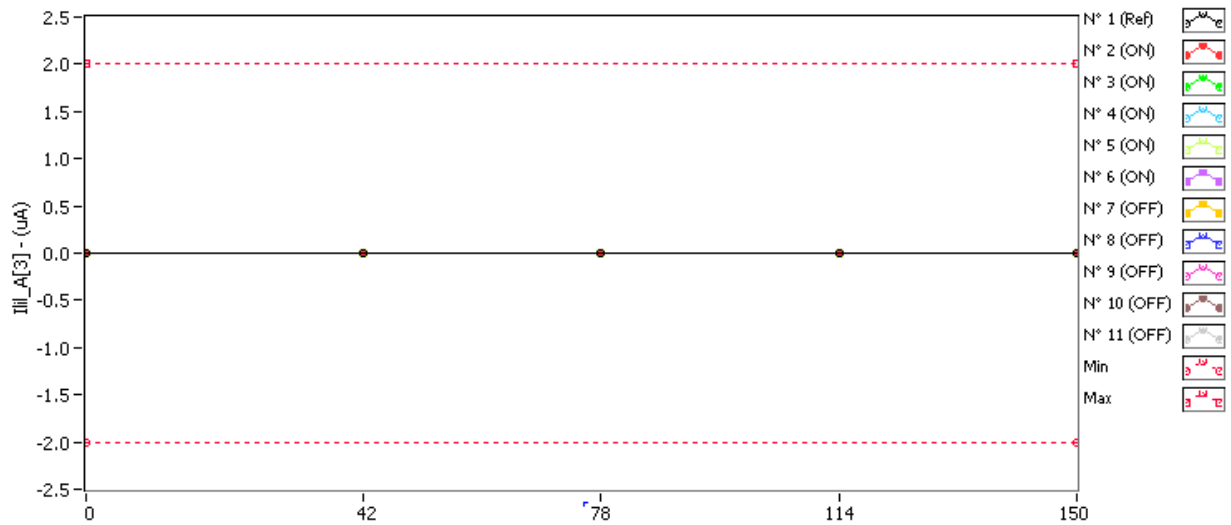

IliI_A[3] . (uA) Min = -2.0 Max = 2.0

	0krad(Si)	42krad(Si)	78krad(Si)	114krad(Si)	150krad(Si)
N° 1 (Ref)	1.772E-3	1.543E-3	3.145E-3	2.916E-3	1.925E-3
N° 2 (ON)	2.459E-3	1.162E-3	1.467E-3	2.840E-3	1.696E-3
N° 3 (ON)	3.145E-3	1.848E-3	1.085E-3	2.154E-3	3.374E-3
N° 4 (ON)	1.238E-3	2.764E-3	1.391E-3	1.009E-3	2.611E-3
N° 5 (ON)	2.154E-3	1.848E-3	1.543E-3	1.238E-3	1.543E-3
N° 6 (ON)	3.145E-3	1.620E-3	1.772E-3	2.993E-3	2.154E-3
N° 7 (OFF)	3.374E-3	1.772E-3	3.069E-3	1.848E-3	1.696E-3
N° 8 (OFF)	1.925E-3	2.840E-3	2.611E-3	1.467E-3	1.009E-3
N° 9 (OFF)	3.069E-3	2.077E-3	2.154E-3	3.145E-3	2.154E-3
N° 10 (OFF)	2.535E-3	3.069E-3	2.764E-3	1.696E-3	2.459E-3
N° 11 (OFF)	1.620E-3	1.085E-3	7.803E-4	2.154E-3	1.620E-3

Delta [IliI_A[3]]

	0krad(Si)	42krad(Si)	78krad(Si)	114krad(Si)	150krad(Si)
N° 1 (Ref)	---	-2.289E-4	1.373E-3	1.144E-3	1.526E-4
N° 2 (ON)	---	-1.297E-3	-9.918E-4	3.815E-4	-7.629E-4
N° 3 (ON)	---	-1.297E-3	-2.060E-3	-9.918E-4	2.289E-4
N° 4 (ON)	---	1.526E-3	1.526E-4	-2.288E-4	1.373E-3
N° 5 (ON)	---	-3.052E-4	-6.104E-4	-9.156E-4	-6.104E-4
N° 6 (ON)	---	-1.526E-3	-1.373E-3	-1.526E-4	-9.918E-4
N° 7 (OFF)	---	-1.602E-3	-3.052E-4	-1.526E-3	-1.679E-3
N° 8 (OFF)	---	9.155E-4	6.866E-4	-4.578E-4	-9.155E-4
N° 9 (OFF)	---	-9.918E-4	-9.155E-4	7.630E-5	-9.155E-4
N° 10 (OFF)	---	5.341E-4	2.289E-4	-8.392E-4	-7.630E-5
N° 11 (OFF)	---	-5.341E-4	-8.392E-4	5.341E-4	0.000E+0
Average (ON)	---	-5.798E-4	-9.766E-4	-3.815E-4	-1.526E-4
s (ON)	---	1.268E-3	8.277E-4	5.735E-4	9.696E-4
Average+3s (ON)	---	3.225E-3	1.507E-3	1.339E-3	2.756E-3
Average-3s (ON)	---	-4.384E-3	-3.460E-3	-2.102E-3	-3.061E-3
Average (OFF)	---	-3.357E-4	-2.289E-4	-4.425E-4	-7.172E-4
s (OFF)	---	1.048E-3	6.887E-4	7.991E-4	6.942E-4
Average+3s (OFF)	---	2.809E-3	1.837E-3	1.955E-3	1.366E-3
Average-3s (OFF)	---	-3.481E-3	-2.295E-3	-2.840E-3	-2.800E-3

29. Ilii_A[4]

Ta = 25°C, Vcc = 3.3V, Vin = 0V

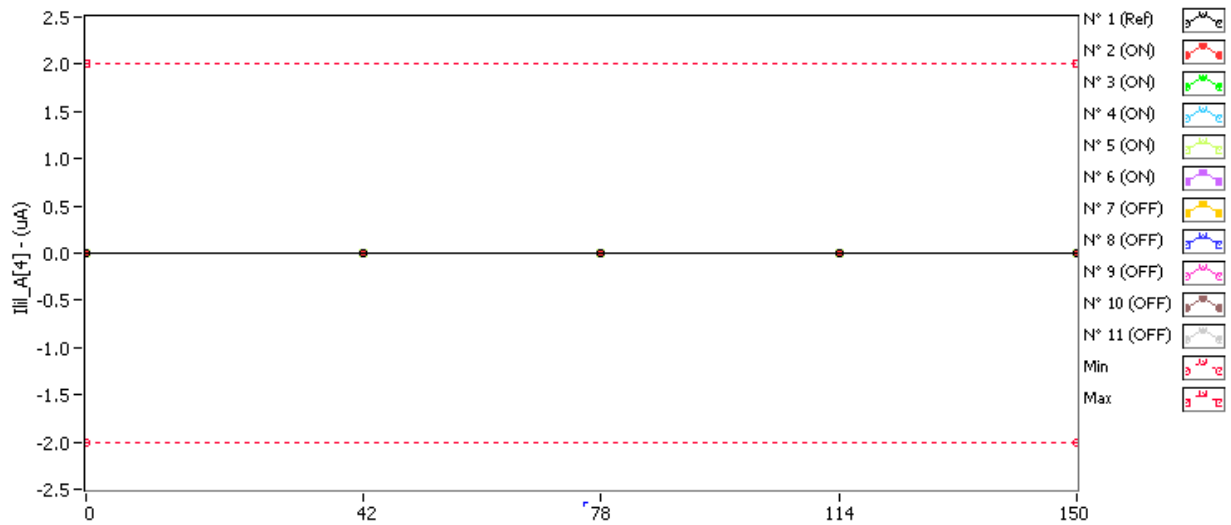

Ilii_A[4] . (uA) Min = -2.0 Max = 2.0

	0krad(Si)	42krad(Si)	78krad(Si)	114krad(Si)	150krad(Si)
N° 1 (Ref)	2.077E-3	7.803E-4	4.751E-4	3.225E-4	1.772E-3
N° 2 (ON)	1.238E-3	1.467E-3	8.566E-4	1.009E-3	2.077E-3
N° 3 (ON)	6.277E-4	1.467E-3	2.382E-3	6.277E-4	2.154E-3
N° 4 (ON)	1.391E-3	7.040E-4	1.238E-3	2.688E-3	2.306E-3
N° 5 (ON)	6.277E-4	2.230E-3	1.925E-3	2.535E-3	2.154E-3
N° 6 (ON)	3.225E-4	1.772E-3	1.085E-3	2.459E-3	2.382E-3
N° 7 (OFF)	1.314E-3	9.329E-4	1.696E-3	2.077E-3	2.077E-3
N° 8 (OFF)	1.085E-3	1.925E-3	1.085E-3	3.988E-4	2.611E-3
N° 9 (OFF)	2.077E-3	1.699E-4	2.306E-3	3.988E-4	6.277E-4
N° 10 (OFF)	2.306E-3	4.751E-4	1.696E-3	2.001E-3	7.803E-4
N° 11 (OFF)	1.238E-3	8.566E-4	2.459E-3	2.077E-3	2.230E-3

Delta [Ilii_A[4]]

	0krad(Si)	42krad(Si)	78krad(Si)	114krad(Si)	150krad(Si)
N° 1 (Ref)	---	-1.297E-3	-1.602E-3	-1.755E-3	-3.052E-4
N° 2 (ON)	---	2.289E-4	-3.814E-4	-2.288E-4	8.393E-4
N° 3 (ON)	---	8.392E-4	1.755E-3	0.000E+0	1.526E-3
N° 4 (ON)	---	-6.866E-4	-1.526E-4	1.297E-3	9.156E-4
N° 5 (ON)	---	1.602E-3	1.297E-3	1.907E-3	1.526E-3
N° 6 (ON)	---	1.450E-3	7.629E-4	2.136E-3	2.060E-3
N° 7 (OFF)	---	-3.814E-4	3.815E-4	7.630E-4	7.630E-4
N° 8 (OFF)	---	8.393E-4	0.000E+0	-6.866E-4	1.526E-3
N° 9 (OFF)	---	-1.907E-3	2.289E-4	-1.678E-3	-1.450E-3
N° 10 (OFF)	---	-1.831E-3	-6.104E-4	-3.052E-4	-1.526E-3
N° 11 (OFF)	---	-3.814E-4	1.221E-3	8.393E-4	9.919E-4
Average (ON)	---	6.867E-4	6.561E-4	1.022E-3	1.373E-3
s (ON)	---	9.406E-4	9.165E-4	1.085E-3	5.031E-4
Average+3s (ON)	---	3.508E-3	3.405E-3	4.278E-3	2.883E-3
Average-3s (ON)	---	-2.135E-3	-2.093E-3	-2.233E-3	-1.361E-4
Average (OFF)	---	-7.324E-4	2.441E-4	-2.136E-4	6.105E-5
s (OFF)	---	1.152E-3	6.638E-4	1.054E-3	1.441E-3
Average+3s (OFF)	---	2.722E-3	2.236E-3	2.947E-3	4.384E-3
Average-3s (OFF)	---	-4.187E-3	-1.747E-3	-3.374E-3	-4.262E-3

30. Ilii_A[5]

Ta = 25°C, Vcc = 3.3V, Vin = 0V

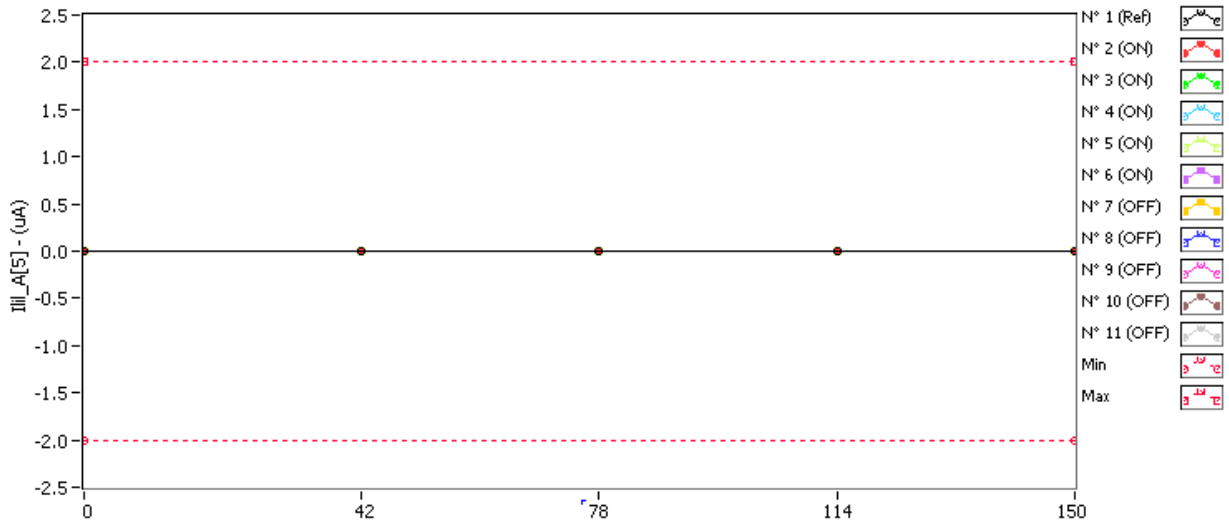

Ilii_A[5] . (uA) Min = -2.0 Max = 2.0

	0krad(Si)	42krad(Si)	78krad(Si)	114krad(Si)	150krad(Si)
N° 1 (Ref)	2.459E-3	1.696E-3	3.988E-4	1.009E-3	2.611E-3
N° 2 (ON)	2.688E-3	7.040E-4	1.772E-3	6.277E-4	6.277E-4
N° 3 (ON)	2.688E-3	1.925E-3	2.382E-3	2.382E-3	8.566E-4
N° 4 (ON)	8.566E-4	2.077E-3	2.535E-3	1.009E-3	9.329E-4
N° 5 (ON)	2.382E-3	2.764E-3	1.162E-3	1.009E-3	2.154E-3
N° 6 (ON)	7.040E-4	1.009E-3	2.459E-3	3.069E-3	8.566E-4
N° 7 (OFF)	2.306E-3	3.988E-4	2.535E-3	6.277E-4	2.306E-3
N° 8 (OFF)	1.620E-3	2.001E-3	1.009E-3	1.620E-3	2.306E-3
N° 9 (OFF)	2.611E-3	2.688E-3	1.925E-3	2.459E-3	1.620E-3
N° 10 (OFF)	1.162E-3	2.001E-3	9.329E-4	1.696E-3	7.803E-4
N° 11 (OFF)	3.988E-4	2.535E-3	2.840E-3	9.329E-4	1.467E-3

Delta [Ilii_A[5]]

	0krad(Si)	42krad(Si)	78krad(Si)	114krad(Si)	150krad(Si)
N° 1 (Ref)	---	-7.629E-4	-2.060E-3	-1.449E-3	1.526E-4
N° 2 (ON)	---	-1.984E-3	-9.155E-4	-2.060E-3	-2.060E-3
N° 3 (ON)	---	-7.629E-4	-3.052E-4	-3.052E-4	-1.831E-3
N° 4 (ON)	---	1.221E-3	1.678E-3	1.526E-4	7.629E-5
N° 5 (ON)	---	3.815E-4	-1.221E-3	-1.373E-3	-2.288E-4
N° 6 (ON)	---	3.052E-4	1.755E-3	2.365E-3	1.526E-4
N° 7 (OFF)	---	-1.907E-3	2.288E-4	-1.679E-3	0.000E+0
N° 8 (OFF)	---	3.815E-4	-6.103E-4	0.000E+0	6.867E-4
N° 9 (OFF)	---	7.630E-5	-6.866E-4	-1.526E-4	-9.918E-4
N° 10 (OFF)	---	8.393E-4	-2.288E-4	5.341E-4	-3.814E-4
N° 11 (OFF)	---	2.136E-3	2.441E-3	5.341E-4	1.068E-3
Average (ON)	---	-1.678E-4	1.983E-4	-2.441E-4	-7.782E-4
s (ON)	---	1.235E-3	1.425E-3	1.699E-3	1.078E-3
Average+3s (ON)	---	3.538E-3	4.473E-3	4.852E-3	2.456E-3
Average-3s (ON)	---	-3.874E-3	-4.076E-3	-5.340E-3	-4.013E-3
Average (OFF)	---	3.052E-4	2.289E-4	-1.526E-4	7.631E-5
s (OFF)	---	1.466E-3	1.289E-3	9.076E-4	8.235E-4
Average+3s (OFF)	---	4.702E-3	4.096E-3	2.570E-3	2.547E-3
Average-3s (OFF)	---	-4.092E-3	-3.638E-3	-2.875E-3	-2.394E-3

31. IliI_A[6]

Ta = 25°C, Vcc = 3.3V, Vin = 0V

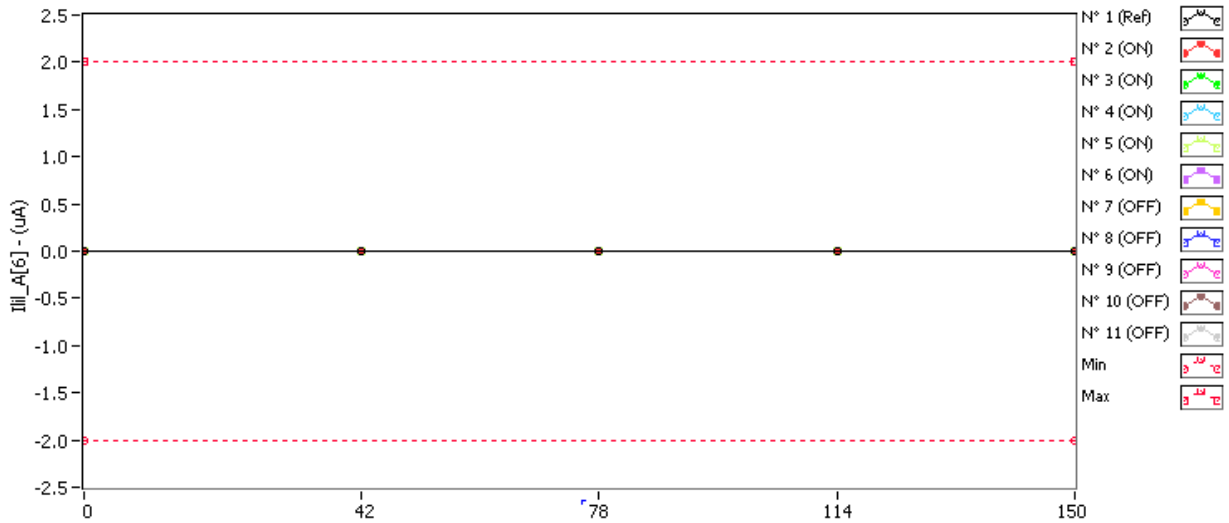

IliI_A[6] . (uA) Min = -2.0 Max = 2.0

	0krad(Si)	42krad(Si)	78krad(Si)	114krad(Si)	150krad(Si)
N° 1 (Ref)	2.535E-3	1.314E-3	2.230E-3	2.916E-3	1.620E-3
N° 2 (ON)	1.085E-3	2.306E-3	7.803E-4	3.374E-3	2.535E-3
N° 3 (ON)	2.382E-3	2.535E-3	2.535E-3	3.069E-3	2.001E-3
N° 4 (ON)	2.840E-3	2.382E-3	2.840E-3	1.848E-3	1.467E-3
N° 5 (ON)	1.085E-3	2.916E-3	1.162E-3	1.772E-3	1.772E-3
N° 6 (ON)	7.803E-4	2.916E-3	2.611E-3	2.077E-3	2.382E-3
N° 7 (OFF)	2.840E-3	1.391E-3	1.848E-3	2.611E-3	1.238E-3
N° 8 (OFF)	1.467E-3	1.314E-3	2.001E-3	1.238E-3	2.382E-3
N° 9 (OFF)	9.329E-4	2.077E-3	1.543E-3	2.382E-3	2.840E-3
N° 10 (OFF)	7.803E-4	7.803E-4	1.543E-3	1.772E-3	1.314E-3
N° 11 (OFF)	1.238E-3	1.238E-3	2.077E-3	2.916E-3	1.009E-3

Delta [IliI_A[6]]

	0krad(Si)	42krad(Si)	78krad(Si)	114krad(Si)	150krad(Si)
N° 1 (Ref)	---	-1.221E-3	-3.051E-4	3.815E-4	-9.155E-4
N° 2 (ON)	---	1.221E-3	-3.051E-4	2.289E-3	1.450E-3
N° 3 (ON)	---	1.526E-4	1.526E-4	6.867E-4	-3.814E-4
N° 4 (ON)	---	-4.578E-4	0.000E+0	-9.918E-4	-1.373E-3
N° 5 (ON)	---	1.831E-3	7.630E-5	6.867E-4	6.867E-4
N° 6 (ON)	---	2.136E-3	1.831E-3	1.297E-3	1.602E-3
N° 7 (OFF)	---	-1.450E-3	-9.918E-4	-2.289E-4	-1.602E-3
N° 8 (OFF)	---	-1.526E-4	5.341E-4	-2.289E-4	9.155E-4
N° 9 (OFF)	---	1.144E-3	6.103E-4	1.450E-3	1.907E-3
N° 10 (OFF)	---	0.000E+0	7.629E-4	9.918E-4	5.340E-4
N° 11 (OFF)	---	0.000E+0	8.393E-4	1.678E-3	-2.288E-4
Average (ON)	---	9.766E-4	3.510E-4	7.935E-4	3.967E-4
s (ON)	---	1.104E-3	8.454E-4	1.194E-3	1.263E-3
Average+3s (ON)	---	4.287E-3	2.887E-3	4.375E-3	4.187E-3
Average-3s (ON)	---	-2.334E-3	-2.185E-3	-2.788E-3	-3.393E-3
Average (OFF)	---	-9.155E-5	3.510E-4	7.324E-4	3.052E-4
s (OFF)	---	9.209E-4	7.603E-4	9.117E-4	1.315E-3
Average+3s (OFF)	---	2.671E-3	2.632E-3	3.468E-3	4.250E-3
Average-3s (OFF)	---	-2.854E-3	-1.930E-3	-2.003E-3	-3.639E-3

32. IliI_A[7]

Ta = 25°C, Vcc = 3.3V, Vin = 0V

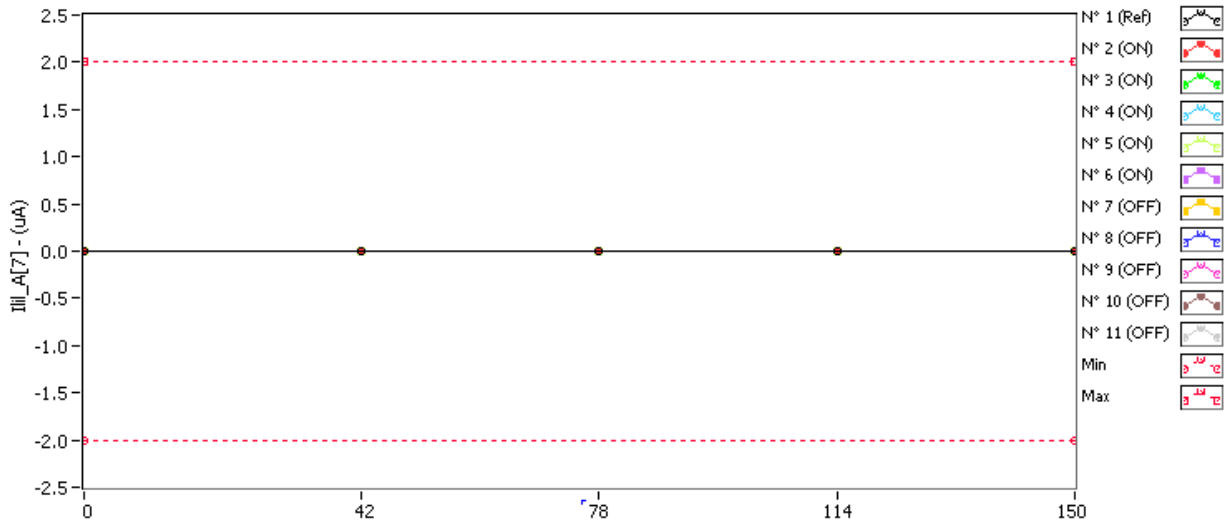

IliI_A[7] . (uA) Min = -2.0 Max = 2.0

	0krad(Si)	42krad(Si)	78krad(Si)	114krad(Si)	150krad(Si)
N° 1 (Ref)	3.222E-3	2.154E-3	2.535E-3	2.230E-3	1.925E-3
N° 2 (ON)	1.620E-3	3.069E-3	1.391E-3	1.009E-3	2.764E-3
N° 3 (ON)	2.154E-3	2.077E-3	2.688E-3	3.298E-3	2.230E-3
N° 4 (ON)	2.688E-3	3.069E-3	3.069E-3	2.688E-3	1.314E-3
N° 5 (ON)	1.925E-3	1.085E-3	1.696E-3	1.543E-3	2.001E-3
N° 6 (ON)	1.467E-3	1.391E-3	1.162E-3	1.620E-3	1.391E-3
N° 7 (OFF)	2.840E-3	3.145E-3	3.222E-3	1.162E-3	1.467E-3
N° 8 (OFF)	2.840E-3	7.040E-4	1.620E-3	2.764E-3	1.085E-3
N° 9 (OFF)	1.314E-3	2.764E-3	2.154E-3	1.009E-3	1.009E-3
N° 10 (OFF)	1.467E-3	3.756E-3	1.772E-3	2.611E-3	2.382E-3
N° 11 (OFF)	1.238E-3	2.154E-3	2.154E-3	1.620E-3	1.848E-3

Delta [IliI_A[7]]

	0krad(Si)	42krad(Si)	78krad(Si)	114krad(Si)	150krad(Si)
N° 1 (Ref)	---	-1.068E-3	-6.867E-4	-9.918E-4	-1.297E-3
N° 2 (ON)	---	1.450E-3	-2.289E-4	-6.103E-4	1.144E-3
N° 3 (ON)	---	-7.630E-5	5.340E-4	1.144E-3	7.630E-5
N° 4 (ON)	---	3.815E-4	3.815E-4	0.000E+0	-1.373E-3
N° 5 (ON)	---	-8.393E-4	-2.289E-4	-3.815E-4	7.630E-5
N° 6 (ON)	---	-7.630E-5	-3.052E-4	1.526E-4	-7.630E-5
N° 7 (OFF)	---	3.052E-4	3.815E-4	-1.679E-3	-1.373E-3
N° 8 (OFF)	---	-2.136E-3	-1.221E-3	-7.630E-5	-1.755E-3
N° 9 (OFF)	---	1.450E-3	8.393E-4	-3.051E-4	-3.051E-4
N° 10 (OFF)	---	2.289E-3	3.052E-4	1.144E-3	9.155E-4
N° 11 (OFF)	---	9.156E-4	9.156E-4	3.815E-4	6.104E-4
Average (ON)	---	1.678E-4	3.050E-5	6.104E-5	-3.052E-5
s (ON)	---	8.400E-4	3.950E-4	6.768E-4	8.956E-4
Average+3s (ON)	---	2.688E-3	1.215E-3	2.091E-3	2.656E-3
Average-3s (ON)	---	-2.352E-3	-1.154E-3	-1.969E-3	-2.717E-3
Average (OFF)	---	5.646E-4	2.442E-4	-1.068E-4	-3.815E-4
s (OFF)	---	1.676E-3	8.622E-4	1.039E-3	1.177E-3
Average+3s (OFF)	---	5.594E-3	2.831E-3	3.009E-3	3.150E-3
Average-3s (OFF)	---	-4.465E-3	-2.342E-3	-3.222E-3	-3.913E-3

33. Ilii_A[8]

Ta = 25°C, Vcc = 3.3V, Vin = 0V

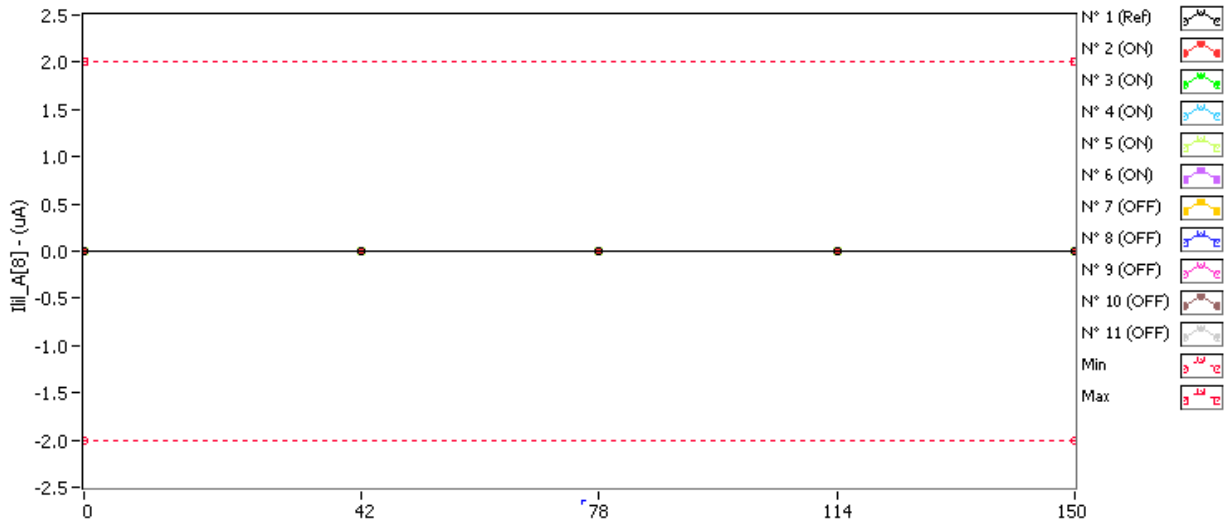

Ilii_A[8] . (uA) Min = -2.0 Max = 2.0

	0krad(Si)	42krad(Si)	78krad(Si)	114krad(Si)	150krad(Si)
N° 1 (Ref)	1.467E-3	1.314E-3	1.772E-3	2.382E-3	1.467E-3
N° 2 (ON)	3.298E-3	1.543E-3	1.925E-3	2.535E-3	3.069E-3
N° 3 (ON)	1.543E-3	1.162E-3	2.916E-3	2.306E-3	3.069E-3
N° 4 (ON)	1.009E-3	9.329E-4	2.001E-3	1.772E-3	2.306E-3
N° 5 (ON)	1.620E-3	1.238E-3	2.535E-3	1.467E-3	2.764E-3
N° 6 (ON)	2.993E-3	1.085E-3	3.069E-3	2.688E-3	1.162E-3
N° 7 (OFF)	8.566E-4	2.535E-3	1.543E-3	1.162E-3	2.154E-3
N° 8 (OFF)	2.382E-3	7.803E-4	1.238E-3	7.040E-4	1.467E-3
N° 9 (OFF)	3.069E-3	7.040E-4	1.696E-3	1.085E-3	1.009E-3
N° 10 (OFF)	1.848E-3	2.459E-3	2.611E-3	2.764E-3	1.543E-3
N° 11 (OFF)	1.238E-3	1.543E-3	1.238E-3	1.925E-3	2.382E-3

Delta [Ilii_A[8]]

	0krad(Si)	42krad(Si)	78krad(Si)	114krad(Si)	150krad(Si)
N° 1 (Ref)	---	-1.526E-4	3.052E-4	9.155E-4	0.000E+0
N° 2 (ON)	---	-1.755E-3	-1.373E-3	-7.630E-4	-2.289E-4
N° 3 (ON)	---	-3.815E-4	1.373E-3	7.630E-4	1.526E-3
N° 4 (ON)	---	-7.634E-5	9.918E-4	7.629E-4	1.297E-3
N° 5 (ON)	---	-3.815E-4	9.155E-4	-1.526E-4	1.144E-3
N° 6 (ON)	---	-1.907E-3	7.630E-5	-3.052E-4	-1.831E-3
N° 7 (OFF)	---	1.678E-3	6.866E-4	3.051E-4	1.297E-3
N° 8 (OFF)	---	-1.602E-3	-1.144E-3	-1.678E-3	-9.155E-4
N° 9 (OFF)	---	-2.365E-3	-1.373E-3	-1.984E-3	-2.060E-3
N° 10 (OFF)	---	6.103E-4	7.629E-4	9.155E-4	-3.052E-4
N° 11 (OFF)	---	3.052E-4	0.000E+0	6.867E-4	1.144E-3
Average (ON)	---	-9.003E-4	3.967E-4	6.102E-5	3.815E-4
s (ON)	---	8.605E-4	1.097E-3	6.790E-4	1.414E-3
Average+3s (ON)	---	1.681E-3	3.687E-3	2.098E-3	4.624E-3
Average-3s (ON)	---	-3.482E-3	-2.894E-3	-1.976E-3	-3.861E-3
Average (OFF)	---	-2.747E-4	-2.136E-4	-3.510E-4	-1.678E-4
s (OFF)	---	1.663E-3	1.003E-3	1.373E-3	1.416E-3
Average+3s (OFF)	---	4.715E-3	2.794E-3	3.768E-3	4.082E-3
Average-3s (OFF)	---	-5.265E-3	-3.221E-3	-4.470E-3	-4.417E-3

34. IliI_A[9]

Ta = 25°C, Vcc = 3.3V, Vin = 0V

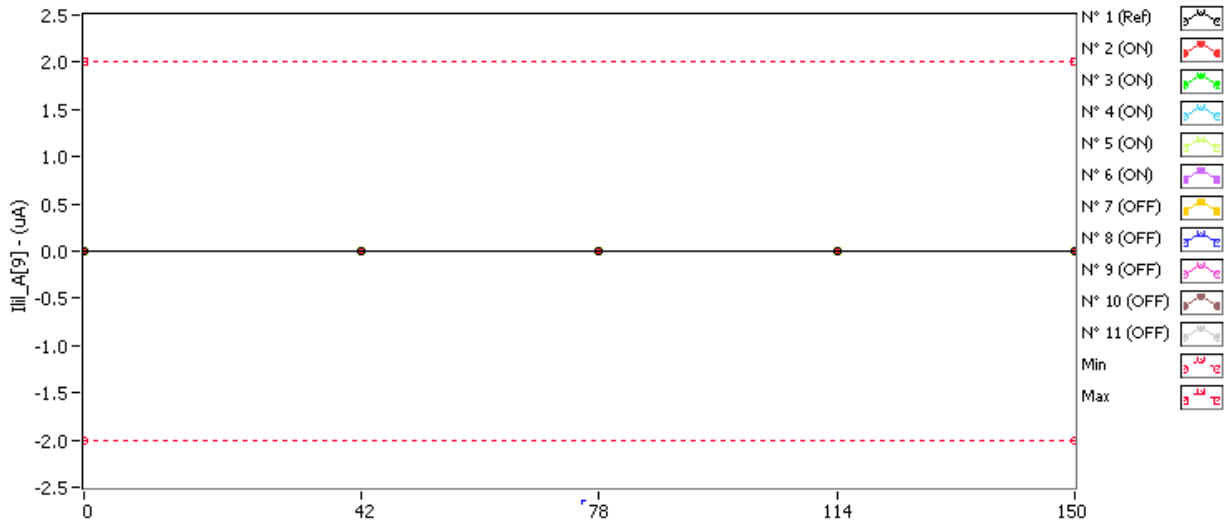

IliI_A[9] . (uA) Min = -2.0 Max = 2.0

	0krad(Si)	42krad(Si)	78krad(Si)	114krad(Si)	150krad(Si)
N° 1 (Ref)	2.001E-3	2.382E-3	1.391E-3	2.306E-3	1.085E-3
N° 2 (ON)	2.077E-3	2.077E-3	2.077E-3	1.696E-3	1.925E-3
N° 3 (ON)	2.306E-3	1.772E-3	2.764E-3	1.848E-3	1.085E-3
N° 4 (ON)	1.391E-3	6.277E-4	3.988E-4	8.566E-4	2.230E-3
N° 5 (ON)	2.306E-3	2.306E-3	3.225E-4	1.696E-3	1.085E-3
N° 6 (ON)	2.077E-3	1.848E-3	7.040E-4	1.848E-3	2.230E-3
N° 7 (OFF)	1.314E-3	6.277E-4	6.277E-4	7.803E-4	9.329E-4
N° 8 (OFF)	2.535E-3	1.467E-3	2.688E-3	-5.896E-5	2.001E-3
N° 9 (OFF)	1.162E-3	1.696E-3	1.772E-3	4.751E-4	1.699E-4
N° 10 (OFF)	1.696E-3	1.009E-3	1.848E-3	1.009E-3	9.329E-4
N° 11 (OFF)	1.467E-3	1.772E-3	2.459E-3	2.230E-3	1.925E-3

Delta [IliI_A[9]]

	0krad(Si)	42krad(Si)	78krad(Si)	114krad(Si)	150krad(Si)
N° 1 (Ref)	---	3.814E-4	-6.104E-4	3.052E-4	-9.156E-4
N° 2 (ON)	---	0.000E+0	0.000E+0	-3.815E-4	-1.526E-4
N° 3 (ON)	---	-5.341E-4	4.577E-4	-4.578E-4	-1.221E-3
N° 4 (ON)	---	-7.629E-4	-9.918E-4	-5.340E-4	8.393E-4
N° 5 (ON)	---	0.000E+0	-1.984E-3	-6.104E-4	-1.221E-3
N° 6 (ON)	---	-2.289E-4	-1.373E-3	-2.289E-4	1.526E-4
N° 7 (OFF)	---	-6.866E-4	-6.866E-4	-5.340E-4	-3.814E-4
N° 8 (OFF)	---	-1.068E-3	1.526E-4	-2.594E-3	-5.340E-4
N° 9 (OFF)	---	5.341E-4	6.104E-4	-6.866E-4	-9.918E-4
N° 10 (OFF)	---	-6.866E-4	1.526E-4	-6.866E-4	-7.629E-4
N° 11 (OFF)	---	3.052E-4	9.918E-4	7.630E-4	4.578E-4
Average (ON)	---	-3.052E-4	-7.782E-4	-4.425E-4	-3.205E-4
s (ON)	---	3.369E-4	9.983E-4	1.468E-4	8.970E-4
Average+3s (ON)	---	7.055E-4	2.217E-3	-2.261E-6	2.370E-3
Average-3s (ON)	---	-1.316E-3	-3.773E-3	-8.828E-4	-3.011E-3
Average (OFF)	---	-3.204E-4	2.442E-4	-7.476E-4	-4.425E-4
s (OFF)	---	6.980E-4	6.277E-4	1.198E-3	5.539E-4
Average+3s (OFF)	---	1.774E-3	2.127E-3	2.847E-3	1.219E-3
Average-3s (OFF)	---	-2.414E-3	-1.639E-3	-4.343E-3	-2.104E-3

35. Iil_A[10]

Ta = 25°C, Vcc = 3.3V, Vin = 0V

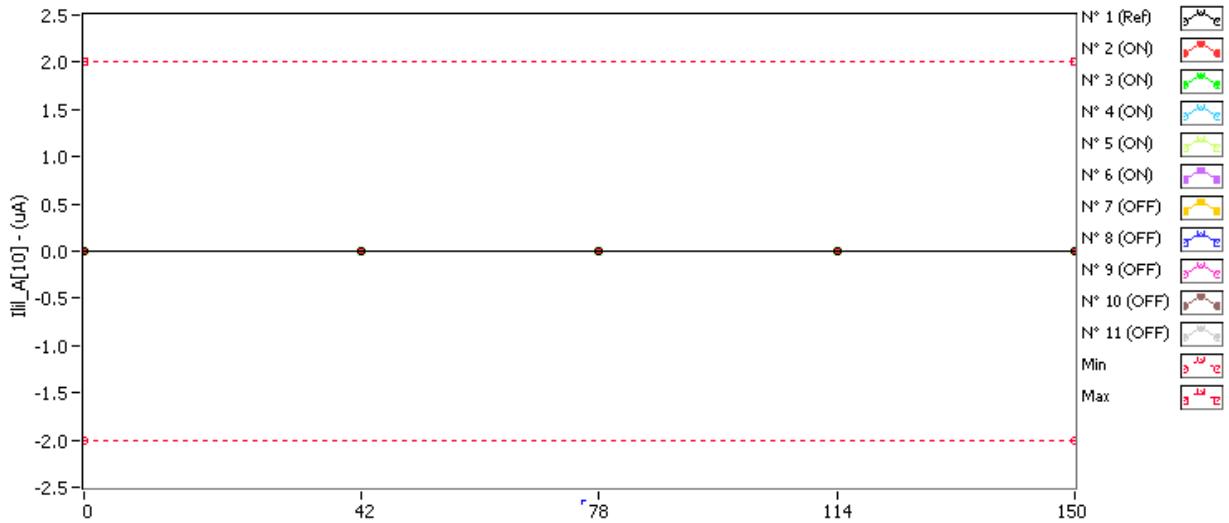

Iil_A[10] . (uA) Min = -2.0 Max = 2.0

	0krad(Si)	42krad(Si)	78krad(Si)	114krad(Si)	150krad(Si)
N° 1 (Ref)	1.772E-3	3.225E-4	1.238E-3	1.009E-3	7.040E-4
N° 2 (ON)	2.459E-3	2.154E-3	5.514E-4	4.751E-4	2.459E-3
N° 3 (ON)	2.535E-3	1.391E-3	1.696E-3	2.154E-3	7.803E-4
N° 4 (ON)	1.238E-3	7.803E-4	2.001E-3	2.611E-3	1.772E-3
N° 5 (ON)	2.306E-3	8.566E-4	2.001E-3	8.566E-4	1.238E-3
N° 6 (ON)	5.514E-4	7.803E-4	1.238E-3	6.277E-4	1.009E-3
N° 7 (OFF)	1.009E-3	2.535E-3	2.688E-3	9.329E-4	2.382E-3
N° 8 (OFF)	3.225E-4	1.085E-3	2.230E-3	2.535E-3	2.611E-3
N° 9 (OFF)	2.230E-3	2.459E-3	2.535E-3	1.085E-3	7.803E-4
N° 10 (OFF)	9.329E-4	1.620E-3	1.848E-3	2.382E-3	1.620E-3
N° 11 (OFF)	3.225E-4	5.514E-4	1.238E-3	3.988E-4	1.238E-3

Delta [Iil_A[10]]

	0krad(Si)	42krad(Si)	78krad(Si)	114krad(Si)	150krad(Si)
N° 1 (Ref)	---	-1.450E-3	-5.341E-4	-7.629E-4	-1.068E-3
N° 2 (ON)	---	-3.051E-4	-1.907E-3	-1.984E-3	0.000E+0
N° 3 (ON)	---	-1.144E-3	-8.392E-4	-3.814E-4	-1.755E-3
N° 4 (ON)	---	-4.577E-4	7.630E-4	1.373E-3	5.341E-4
N° 5 (ON)	---	-1.450E-3	-3.052E-4	-1.450E-3	-1.068E-3
N° 6 (ON)	---	2.289E-4	6.866E-4	7.630E-5	4.578E-4
N° 7 (OFF)	---	1.526E-3	1.678E-3	-7.634E-5	1.373E-3
N° 8 (OFF)	---	7.629E-4	1.907E-3	2.212E-3	2.289E-3
N° 9 (OFF)	---	2.288E-4	3.051E-4	-1.144E-3	-1.450E-3
N° 10 (OFF)	---	6.866E-4	9.155E-4	1.450E-3	6.866E-4
N° 11 (OFF)	---	2.289E-4	9.155E-4	7.629E-5	9.155E-4
Average (ON)	---	-6.256E-4	-3.204E-4	-4.730E-4	-3.662E-4
s (ON)	---	6.725E-4	1.115E-3	1.319E-3	1.006E-3
Average+3s (ON)	---	1.392E-3	3.025E-3	3.483E-3	2.650E-3
Average-3s (ON)	---	-2.643E-3	-3.666E-3	-4.429E-3	-3.383E-3
Average (OFF)	---	6.866E-4	1.144E-3	5.035E-4	7.629E-4
s (OFF)	---	5.313E-4	6.474E-4	1.328E-3	1.381E-3
Average+3s (OFF)	---	2.281E-3	3.087E-3	4.486E-3	4.905E-3
Average-3s (OFF)	---	-9.073E-4	-7.978E-4	-3.479E-3	-3.379E-3

36. Ili1_A[11]

Ta = 25°C, Vcc = 3.3V, Vin = 0V

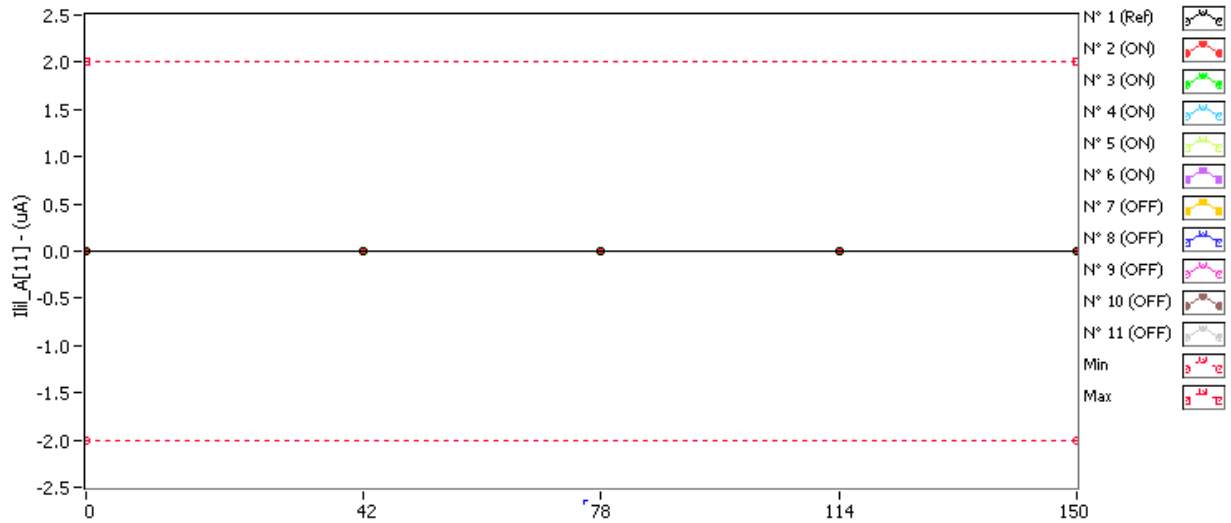

Ili1_A[11] . (uA) Min = -2.0 Max = 2.0

	0krad(Si)	42krad(Si)	78krad(Si)	114krad(Si)	150krad(Si)
N° 1 (Ref)	1.543E-3	2.764E-3	1.848E-3	3.145E-3	1.391E-3
N° 2 (ON)	2.382E-3	2.840E-3	1.391E-3	3.298E-3	2.840E-3
N° 3 (ON)	2.688E-3	2.154E-3	1.314E-3	1.620E-3	1.772E-3
N° 4 (ON)	1.391E-3	2.306E-3	8.566E-4	2.916E-3	2.382E-3
N° 5 (ON)	2.993E-3	1.925E-3	1.238E-3	2.154E-3	2.154E-3
N° 6 (ON)	2.611E-3	1.696E-3	2.993E-3	2.535E-3	1.620E-3
N° 7 (OFF)	2.306E-3	2.688E-3	8.566E-4	2.459E-3	1.925E-3
N° 8 (OFF)	1.238E-3	3.145E-3	2.993E-3	1.467E-3	2.993E-3
N° 9 (OFF)	2.001E-3	1.467E-3	3.222E-3	1.925E-3	2.077E-3
N° 10 (OFF)	3.069E-3	2.154E-3	1.848E-3	2.840E-3	2.916E-3
N° 11 (OFF)	3.374E-3	1.543E-3	1.467E-3	3.374E-3	2.840E-3

Delta [Ili1_A[11]]

	0krad(Si)	42krad(Si)	78krad(Si)	114krad(Si)	150krad(Si)
N° 1 (Ref)	---	1.221E-3	3.052E-4	1.602E-3	-1.526E-4
N° 2 (ON)	---	4.578E-4	-9.918E-4	9.156E-4	4.578E-4
N° 3 (ON)	---	-5.340E-4	-1.373E-3	-1.068E-3	-9.155E-4
N° 4 (ON)	---	9.156E-4	-5.340E-4	1.526E-3	9.918E-4
N° 5 (ON)	---	-1.068E-3	-1.755E-3	-8.392E-4	-8.392E-4
N° 6 (ON)	---	-9.155E-4	3.815E-4	-7.630E-5	-9.918E-4
N° 7 (OFF)	---	3.814E-4	-1.450E-3	1.525E-4	-3.815E-4
N° 8 (OFF)	---	1.907E-3	1.755E-3	2.289E-4	1.755E-3
N° 9 (OFF)	---	-5.341E-4	1.221E-3	-7.630E-5	7.630E-5
N° 10 (OFF)	---	-9.155E-4	-1.221E-3	-2.289E-4	-1.526E-4
N° 11 (OFF)	---	-1.831E-3	-1.907E-3	0.000E+0	-5.341E-4
Average (ON)	---	-2.288E-4	-8.545E-4	9.158E-4	-2.594E-4
s (ON)	---	8.732E-4	8.260E-4	1.115E-3	9.196E-4
Average+3s (ON)	---	2.391E-3	1.623E-3	3.438E-3	2.500E-3
Average-3s (ON)	---	-2.849E-3	-3.332E-3	-3.254E-3	-3.018E-3
Average (OFF)	---	-1.984E-4	-3.204E-4	1.524E-5	1.526E-4
s (OFF)	---	1.420E-3	1.680E-3	1.821E-4	9.250E-4
Average+3s (OFF)	---	4.061E-3	4.719E-3	5.617E-4	2.928E-3
Average-3s (OFF)	---	-4.458E-3	-5.360E-3	-5.312E-4	-2.623E-3

37. IliI_A[12]

Ta = 25°C, Vcc = 3.3V, Vin = 0V

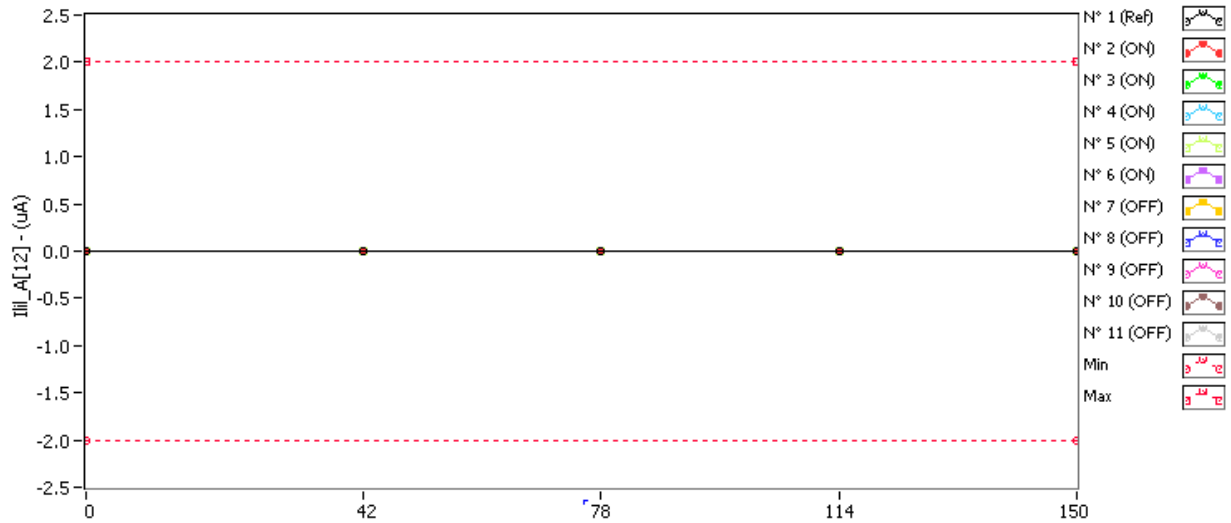

IliI_A[12] . (uA) Min = -2.0 Max = 2.0

	0krad(Si)	42krad(Si)	78krad(Si)	114krad(Si)	150krad(Si)
N° 1 (Ref)	1.085E-3	2.535E-3	1.772E-3	9.329E-4	2.001E-3
N° 2 (ON)	1.620E-3	1.009E-3	1.772E-3	2.611E-3	1.467E-3
N° 3 (ON)	2.993E-3	7.803E-4	2.382E-3	6.277E-4	4.751E-4
N° 4 (ON)	1.391E-3	1.543E-3	1.162E-3	5.514E-4	1.009E-3
N° 5 (ON)	1.467E-3	2.459E-3	2.306E-3	1.009E-3	8.566E-4
N° 6 (ON)	2.764E-3	2.916E-3	2.382E-3	1.238E-3	7.803E-4
N° 7 (OFF)	7.803E-4	2.688E-3	1.696E-3	4.751E-4	7.803E-4
N° 8 (OFF)	7.803E-4	3.988E-4	2.382E-3	1.543E-3	2.230E-3
N° 9 (OFF)	1.696E-3	5.514E-4	2.230E-3	2.001E-3	2.535E-3
N° 10 (OFF)	1.391E-3	1.696E-3	1.085E-3	7.803E-4	1.699E-4
N° 11 (OFF)	6.277E-4	7.803E-4	1.620E-3	1.467E-3	1.543E-3

Delta [IliI_A[12]]

	0krad(Si)	42krad(Si)	78krad(Si)	114krad(Si)	150krad(Si)
N° 1 (Ref)	---	1.450E-3	6.867E-4	-1.525E-4	9.156E-4
N° 2 (ON)	---	-6.103E-4	1.526E-4	9.918E-4	-1.526E-4
N° 3 (ON)	---	-2.213E-3	-6.104E-4	-2.365E-3	-2.518E-3
N° 4 (ON)	---	1.526E-4	-2.289E-4	-8.392E-4	-3.814E-4
N° 5 (ON)	---	9.918E-4	8.393E-4	-4.577E-4	-6.103E-4
N° 6 (ON)	---	1.526E-4	-3.815E-4	-1.526E-3	-1.984E-3
N° 7 (OFF)	---	1.907E-3	9.155E-4	-3.052E-4	0.000E+0
N° 8 (OFF)	---	-3.815E-4	1.602E-3	7.629E-4	1.450E-3
N° 9 (OFF)	---	-1.144E-3	5.341E-4	3.052E-4	8.392E-4
N° 10 (OFF)	---	3.052E-4	-3.052E-4	-6.103E-4	-1.221E-3
N° 11 (OFF)	---	1.526E-4	9.918E-4	8.392E-4	9.155E-4
Average (ON)	---	-3.052E-4	-4.578E-5	-8.392E-4	-1.129E-3
s (ON)	---	1.208E-3	5.674E-4	1.255E-3	1.054E-3
Average+3s (ON)	---	3.317E-3	1.656E-3	2.925E-3	2.032E-3
Average-3s (ON)	---	-3.928E-3	-1.748E-3	-4.604E-3	-4.290E-3
Average (OFF)	---	1.678E-4	7.477E-4	1.984E-4	3.967E-4
s (OFF)	---	1.126E-3	7.021E-4	6.419E-4	1.042E-3
Average+3s (OFF)	---	3.545E-3	2.854E-3	2.124E-3	3.524E-3
Average-3s (OFF)	---	-3.209E-3	-1.359E-3	-1.727E-3	-2.731E-3

38. IliI_A[13]

Ta = 25°C, Vcc = 3.3V, Vin = 0V

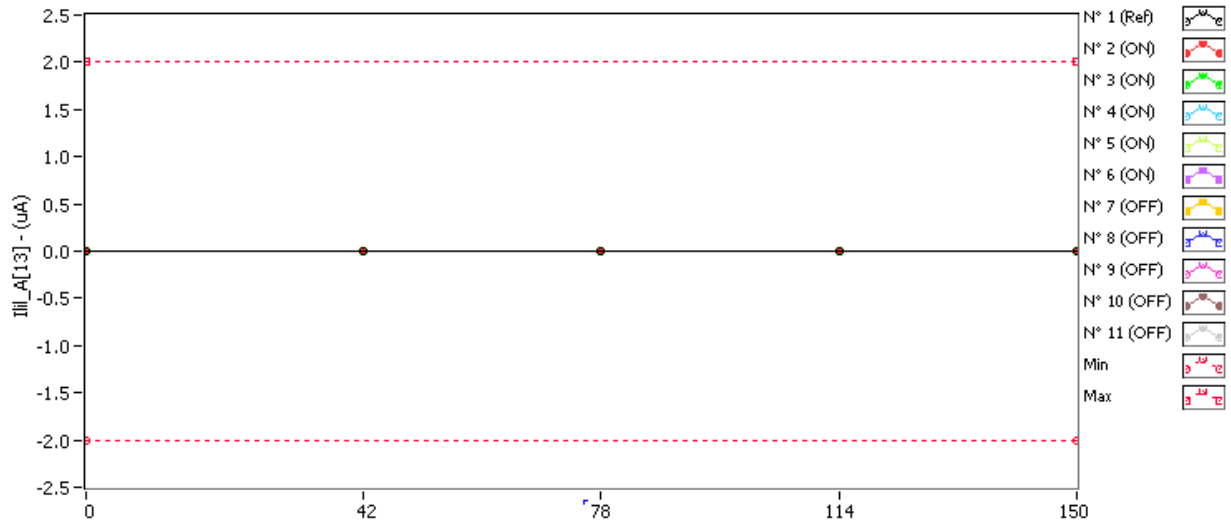

IliI_A[13] . (uA) Min = -2.0 Max = 2.0

	0krad(Si)	42krad(Si)	78krad(Si)	114krad(Si)	150krad(Si)
N° 1 (Ref)	1.543E-3	2.535E-3	1.696E-3	2.001E-3	1.391E-3
N° 2 (ON)	1.467E-3	3.069E-3	1.391E-3	2.459E-3	1.925E-3
N° 3 (ON)	1.772E-3	1.925E-3	3.298E-3	2.611E-3	1.620E-3
N° 4 (ON)	1.467E-3	1.467E-3	2.001E-3	3.069E-3	2.230E-3
N° 5 (ON)	1.696E-3	3.222E-3	3.298E-3	1.238E-3	1.314E-3
N° 6 (ON)	1.543E-3	2.993E-3	3.069E-3	2.993E-3	2.001E-3
N° 7 (OFF)	1.620E-3	2.764E-3	1.467E-3	1.467E-3	2.688E-3
N° 8 (OFF)	1.314E-3	1.543E-3	7.040E-4	2.688E-3	1.543E-3
N° 9 (OFF)	2.459E-3	1.772E-3	2.764E-3	2.764E-3	2.840E-3
N° 10 (OFF)	1.238E-3	2.993E-3	1.620E-3	9.329E-4	2.993E-3
N° 11 (OFF)	1.467E-3	2.535E-3	1.467E-3	2.230E-3	2.916E-3

Delta [IliI_A[13]]

	0krad(Si)	42krad(Si)	78krad(Si)	114krad(Si)	150krad(Si)
N° 1 (Ref)	---	9.918E-4	1.526E-4	4.578E-4	-1.526E-4
N° 2 (ON)	---	1.602E-3	-7.630E-5	9.918E-4	4.578E-4
N° 3 (ON)	---	1.526E-4	1.526E-3	8.392E-4	-1.526E-4
N° 4 (ON)	---	0.000E+0	5.341E-4	1.602E-3	7.630E-4
N° 5 (ON)	---	1.526E-3	1.602E-3	-4.578E-4	-3.815E-4
N° 6 (ON)	---	1.450E-3	1.526E-3	1.450E-3	4.578E-4
N° 7 (OFF)	---	1.144E-3	-1.526E-4	-1.526E-4	1.068E-3
N° 8 (OFF)	---	2.289E-4	-6.103E-4	1.373E-3	2.289E-4
N° 9 (OFF)	---	-6.866E-4	3.052E-4	3.052E-4	3.815E-4
N° 10 (OFF)	---	1.755E-3	3.815E-4	-3.051E-4	1.755E-3
N° 11 (OFF)	---	1.068E-3	0.000E+0	7.630E-4	1.450E-3
Average (ON)	---	9.461E-4	1.022E-3	8.850E-4	2.289E-4
s (ON)	---	7.976E-4	7.564E-4	8.139E-4	4.765E-4
Average+3s (ON)	---	3.339E-3	3.292E-3	3.327E-3	1.658E-3
Average-3s (ON)	---	-1.447E-3	-1.247E-3	-1.557E-3	-1.201E-3
Average (OFF)	---	7.019E-4	-1.524E-5	3.968E-4	9.766E-4
s (OFF)	---	9.474E-4	3.979E-4	6.875E-4	6.616E-4
Average+3s (OFF)	---	3.544E-3	1.178E-3	2.459E-3	2.961E-3
Average-3s (OFF)	---	-2.140E-3	-1.209E-3	-1.666E-3	-1.008E-3

39. Ili1_A[14]

Ta = 25°C, Vcc = 3.3V, Vin = 0V

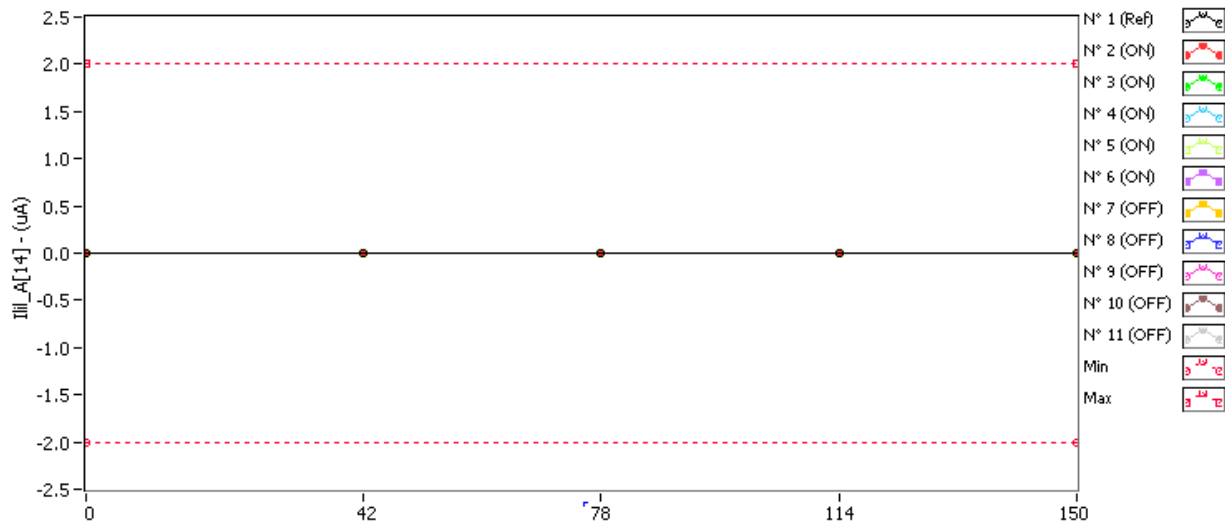

Ili1_A[14] . (uA) Min = -2.0 Max = 2.0

	0krad(Si)	42krad(Si)	78krad(Si)	114krad(Si)	150krad(Si)
N° 1 (Ref)	1.620E-3	2.459E-3	2.535E-3	2.840E-3	1.772E-3
N° 2 (ON)	1.085E-3	2.535E-3	2.077E-3	2.077E-3	9.329E-4
N° 3 (ON)	7.040E-4	1.238E-3	1.009E-3	6.277E-4	1.238E-3
N° 4 (ON)	1.314E-3	2.688E-3	1.696E-3	8.566E-4	9.329E-4
N° 5 (ON)	2.382E-3	2.230E-3	2.001E-3	1.009E-3	2.688E-3
N° 6 (ON)	2.611E-3	6.277E-4	1.238E-3	1.314E-3	2.688E-3
N° 7 (OFF)	4.751E-4	7.803E-4	1.009E-3	2.611E-3	7.803E-4
N° 8 (OFF)	5.514E-4	1.391E-3	1.238E-3	2.230E-3	3.225E-4
N° 9 (OFF)	1.162E-3	7.040E-4	2.459E-3	2.535E-3	2.001E-3
N° 10 (OFF)	2.611E-3	1.848E-3	2.077E-3	1.467E-3	2.459E-3
N° 11 (OFF)	2.382E-3	7.803E-4	1.467E-3	2.916E-3	2.611E-3

Delta [Ili1_A[14]]

	0krad(Si)	42krad(Si)	78krad(Si)	114krad(Si)	150krad(Si)
N° 1 (Ref)	---	8.392E-4	9.155E-4	1.221E-3	1.526E-4
N° 2 (ON)	---	1.450E-3	9.919E-4	9.919E-4	-1.525E-4
N° 3 (ON)	---	5.340E-4	3.052E-4	-7.629E-5	5.340E-4
N° 4 (ON)	---	1.373E-3	3.815E-4	-4.577E-4	-3.814E-4
N° 5 (ON)	---	-1.525E-4	-3.814E-4	-1.373E-3	3.052E-4
N° 6 (ON)	---	-1.984E-3	-1.373E-3	-1.297E-3	7.630E-5
N° 7 (OFF)	---	3.052E-4	5.341E-4	2.136E-3	3.052E-4
N° 8 (OFF)	---	8.392E-4	6.866E-4	1.679E-3	-2.289E-4
N° 9 (OFF)	---	-4.577E-4	1.297E-3	1.373E-3	8.393E-4
N° 10 (OFF)	---	-7.629E-4	-5.340E-4	-1.144E-3	-1.526E-4
N° 11 (OFF)	---	-1.602E-3	-9.155E-4	5.341E-4	2.289E-4
Average (ON)	---	2.442E-4	-1.522E-5	-4.425E-4	7.631E-5
s (ON)	---	1.408E-3	9.018E-4	9.732E-4	3.619E-4
Average+3s (ON)	---	4.469E-3	2.690E-3	2.477E-3	1.162E-3
Average-3s (ON)	---	-3.981E-3	-2.721E-3	-3.362E-3	-1.009E-3
Average (OFF)	---	-3.357E-4	2.136E-4	9.155E-4	1.984E-4
s (OFF)	---	9.477E-4	9.130E-4	1.291E-3	4.269E-4
Average+3s (OFF)	---	2.507E-3	2.953E-3	4.790E-3	1.479E-3
Average-3s (OFF)	---	-3.179E-3	-2.525E-3	-2.959E-3	-1.082E-3

40. Ilil_A[15]

Ta = 25°C, Vcc = 3.3V, Vin = 0V

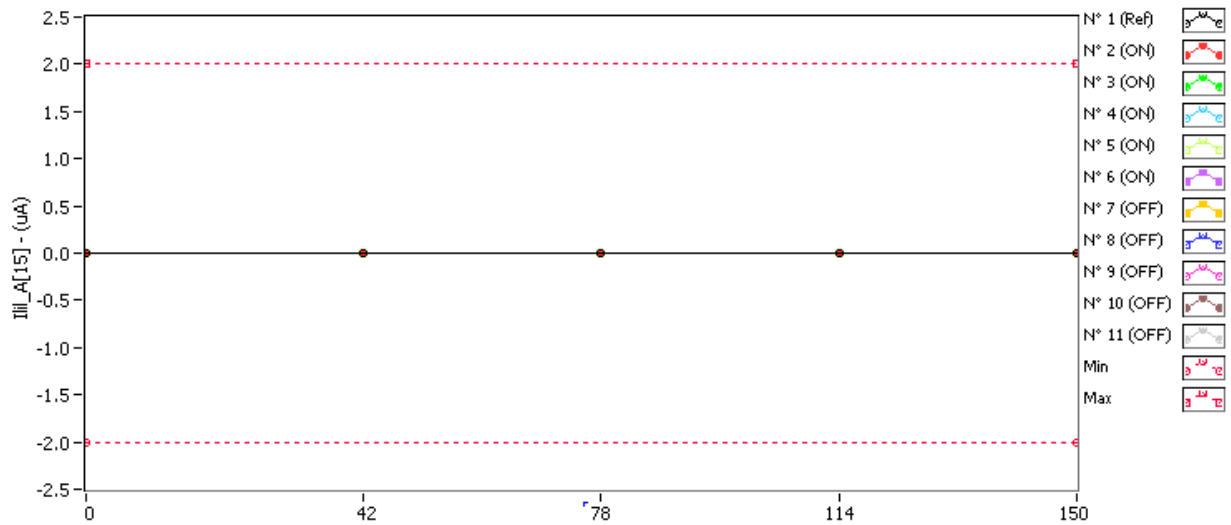

Ilil_A[15] . (uA) Min = -2.0 Max = 2.0

	0krad(Si)	42krad(Si)	78krad(Si)	114krad(Si)	150krad(Si)
N° 1 (Ref)	2.840E-3	3.069E-3	3.069E-3	2.840E-3	2.306E-3
N° 2 (ON)	1.238E-3	3.145E-3	2.916E-3	3.069E-3	2.688E-3
N° 3 (ON)	2.688E-3	2.916E-3	3.298E-3	3.298E-3	3.145E-3
N° 4 (ON)	2.535E-3	2.688E-3	3.145E-3	3.527E-3	2.916E-3
N° 5 (ON)	2.306E-3	2.840E-3	2.840E-3	1.085E-3	1.238E-3
N° 6 (ON)	3.298E-3	1.162E-3	1.848E-3	1.772E-3	1.696E-3
N° 7 (OFF)	2.916E-3	3.298E-3	2.459E-3	2.535E-3	2.840E-3
N° 8 (OFF)	1.314E-3	1.238E-3	1.467E-3	3.603E-3	1.925E-3
N° 9 (OFF)	1.925E-3	1.467E-3	2.840E-3	9.329E-4	3.069E-3
N° 10 (OFF)	1.848E-3	2.688E-3	2.916E-3	2.154E-3	2.916E-3
N° 11 (OFF)	3.298E-3	2.001E-3	2.459E-3	1.696E-3	1.620E-3

Delta [Ilil_A[15]]

	0krad(Si)	42krad(Si)	78krad(Si)	114krad(Si)	150krad(Si)
N° 1 (Ref)	---	2.289E-4	2.289E-4	0.000E+0	-5.340E-4
N° 2 (ON)	---	1.907E-3	1.678E-3	1.831E-3	1.450E-3
N° 3 (ON)	---	2.289E-4	6.104E-4	6.104E-4	4.578E-4
N° 4 (ON)	---	1.526E-4	6.104E-4	9.919E-4	3.815E-4
N° 5 (ON)	---	5.340E-4	5.340E-4	-1.221E-3	-1.068E-3
N° 6 (ON)	---	-2.136E-3	-1.450E-3	-1.526E-3	-1.602E-3
N° 7 (OFF)	---	3.815E-4	-4.578E-4	-3.815E-4	-7.630E-5
N° 8 (OFF)	---	-7.630E-5	1.526E-4	2.289E-3	6.104E-4
N° 9 (OFF)	---	-4.578E-4	9.155E-4	-9.918E-4	1.144E-3
N° 10 (OFF)	---	8.392E-4	1.068E-3	3.052E-4	1.068E-3
N° 11 (OFF)	---	-1.297E-3	-8.393E-4	-1.602E-3	-1.679E-3
Average (ON)	---	1.373E-4	3.967E-4	1.373E-4	-7.630E-5
s (ON)	---	1.455E-3	1.136E-3	1.452E-3	1.238E-3
Average+3s (ON)	---	4.502E-3	3.805E-3	4.493E-3	3.639E-3
Average-3s (ON)	---	-4.228E-3	-3.011E-3	-4.219E-3	-3.792E-3
Average (OFF)	---	-1.221E-4	1.678E-4	-7.631E-5	2.136E-4
s (OFF)	---	8.174E-4	8.330E-4	1.500E-3	1.164E-3
Average+3s (OFF)	---	2.330E-3	2.667E-3	4.423E-3	3.705E-3
Average-3s (OFF)	---	-2.574E-3	-2.331E-3	-4.576E-3	-3.278E-3

41. Ilil_A[16]

Ta = 25°C, Vcc = 3.3V, Vin = 0V

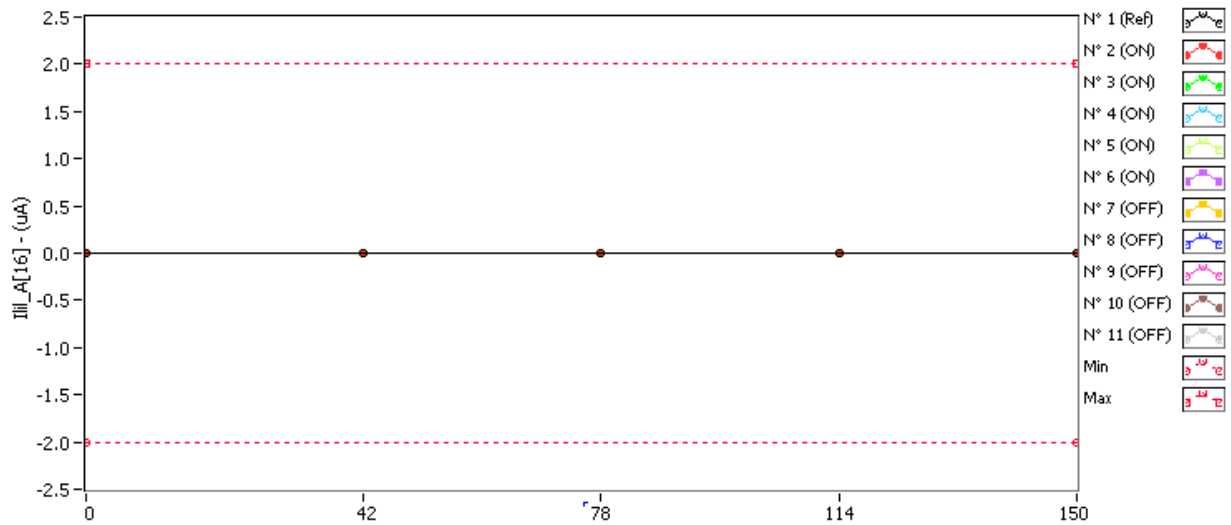

Ilil_A[16] . (uA) Min = -2.0 Max = 2.0

	0krad(Si)	42krad(Si)	78krad(Si)	114krad(Si)	150krad(Si)
N° 1 (Ref)	1.009E-3	2.535E-3	9.329E-4	7.040E-4	1.543E-3
N° 2 (ON)	1.238E-3	9.329E-4	2.764E-3	7.040E-4	1.314E-3
N° 3 (ON)	1.238E-3	1.620E-3	2.688E-3	1.009E-3	1.543E-3
N° 4 (ON)	7.803E-4	1.238E-3	3.225E-4	2.230E-3	1.696E-3
N° 5 (ON)	2.001E-3	2.916E-3	2.001E-3	2.916E-3	1.696E-3
N° 6 (ON)	8.566E-4	1.696E-3	2.611E-3	1.391E-3	1.620E-3
N° 7 (OFF)	8.566E-4	2.154E-3	1.009E-3	7.040E-4	2.382E-3
N° 8 (OFF)	1.085E-3	7.803E-4	1.543E-3	2.611E-3	1.238E-3
N° 9 (OFF)	9.329E-4	3.069E-3	2.840E-3	2.840E-3	2.077E-3
N° 10 (OFF)	2.611E-3	2.764E-3	2.459E-3	2.230E-3	8.566E-4
N° 11 (OFF)	2.611E-3	2.916E-3	2.459E-3	1.162E-3	1.085E-3

Delta [Ilil_A[16]]

	0krad(Si)	42krad(Si)	78krad(Si)	114krad(Si)	150krad(Si)
N° 1 (Ref)	---	1.526E-3	-7.634E-5	-3.052E-4	5.340E-4
N° 2 (ON)	---	-3.051E-4	1.526E-3	-5.340E-4	7.630E-5
N° 3 (ON)	---	3.815E-4	1.450E-3	-2.288E-4	3.052E-4
N° 4 (ON)	---	4.577E-4	-4.578E-4	1.450E-3	9.155E-4
N° 5 (ON)	---	9.155E-4	0.000E+0	9.155E-4	-3.052E-4
N° 6 (ON)	---	8.392E-4	1.755E-3	5.340E-4	7.629E-4
N° 7 (OFF)	---	1.297E-3	1.526E-4	-1.526E-4	1.526E-3
N° 8 (OFF)	---	-3.051E-4	4.578E-4	1.526E-3	1.526E-4
N° 9 (OFF)	---	2.136E-3	1.907E-3	1.907E-3	1.144E-3
N° 10 (OFF)	---	1.526E-4	-1.526E-4	-3.814E-4	-1.755E-3
N° 11 (OFF)	---	3.052E-4	-1.526E-4	-1.450E-3	-1.526E-3
Average (ON)	---	4.578E-4	8.545E-4	4.273E-4	3.510E-4
s (ON)	---	4.855E-4	1.008E-3	8.139E-4	4.991E-4
Average+3s (ON)	---	1.914E-3	3.880E-3	2.869E-3	1.848E-3
Average-3s (ON)	---	-9.988E-4	-2.171E-3	-2.014E-3	-1.146E-3
Average (OFF)	---	7.172E-4	4.425E-4	2.899E-4	-9.155E-5
s (OFF)	---	9.853E-4	8.571E-4	1.398E-3	1.502E-3
Average+3s (OFF)	---	3.673E-3	3.014E-3	4.484E-3	4.415E-3
Average-3s (OFF)	---	-2.239E-3	-2.129E-3	-3.904E-3	-4.598E-3

42. Ili1_A[17]

Ta = 25°C, Vcc = 3.3V, Vin = 0V

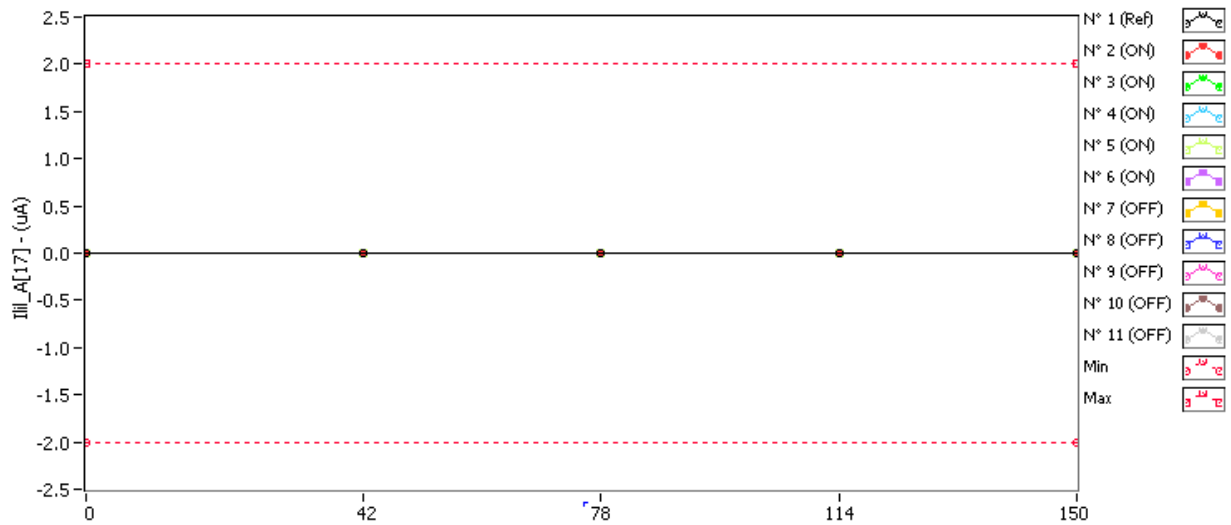

Ili1_A[17] . (uA) Min = -2.0 Max = 2.0

	0krad(Si)	42krad(Si)	78krad(Si)	114krad(Si)	150krad(Si)
N° 1 (Ref)	1.848E-3	2.916E-3	3.527E-3	2.077E-3	2.535E-3
N° 2 (ON)	1.238E-3	2.230E-3	8.566E-4	2.688E-3	1.467E-3
N° 3 (ON)	1.467E-3	2.306E-3	2.459E-3	9.329E-4	2.916E-3
N° 4 (ON)	2.459E-3	2.306E-3	1.772E-3	1.925E-3	2.840E-3
N° 5 (ON)	2.230E-3	1.848E-3	3.451E-3	2.306E-3	1.467E-3
N° 6 (ON)	1.162E-3	2.993E-3	1.772E-3	2.611E-3	2.840E-3
N° 7 (OFF)	1.391E-3	3.374E-3	2.535E-3	2.688E-3	1.467E-3
N° 8 (OFF)	3.145E-3	1.391E-3	2.459E-3	3.145E-3	2.154E-3
N° 9 (OFF)	1.620E-3	2.077E-3	1.314E-3	2.916E-3	2.916E-3
N° 10 (OFF)	2.916E-3	2.840E-3	1.162E-3	3.069E-3	3.145E-3
N° 11 (OFF)	3.222E-3	1.620E-3	1.696E-3	1.467E-3	1.543E-3

Delta [Ili1_A[17]]

	0krad(Si)	42krad(Si)	78krad(Si)	114krad(Si)	150krad(Si)
N° 1 (Ref)	---	1.068E-3	1.678E-3	2.289E-4	6.866E-4
N° 2 (ON)	---	9.919E-4	-3.814E-4	1.450E-3	2.289E-4
N° 3 (ON)	---	8.393E-4	9.918E-4	-5.340E-4	1.450E-3
N° 4 (ON)	---	-1.525E-4	-6.866E-4	-5.340E-4	3.815E-4
N° 5 (ON)	---	-3.815E-4	1.221E-3	7.630E-5	-7.630E-4
N° 6 (ON)	---	1.831E-3	6.104E-4	1.450E-3	1.679E-3
N° 7 (OFF)	---	1.984E-3	1.144E-3	1.297E-3	7.630E-5
N° 8 (OFF)	---	-1.755E-3	-6.867E-4	0.000E+0	-9.918E-4
N° 9 (OFF)	---	4.578E-4	-3.052E-4	1.297E-3	1.297E-3
N° 10 (OFF)	---	-7.630E-5	-1.755E-3	1.526E-4	2.289E-4
N° 11 (OFF)	---	-1.602E-3	-1.526E-3	-1.755E-3	-1.679E-3
Average (ON)	---	6.257E-4	3.510E-4	3.815E-4	5.951E-4
s (ON)	---	9.018E-4	8.437E-4	1.006E-3	9.910E-4
Average+3s (ON)	---	3.331E-3	2.882E-3	3.401E-3	3.568E-3
Average-3s (ON)	---	-2.080E-3	-2.180E-3	-2.638E-3	-2.378E-3
Average (OFF)	---	-1.984E-4	-6.256E-4	1.984E-4	-2.136E-4
s (OFF)	---	1.549E-3	1.154E-3	1.252E-3	1.153E-3
Average+3s (OFF)	---	4.449E-3	2.836E-3	3.954E-3	3.244E-3
Average-3s (OFF)	---	-4.846E-3	-4.087E-3	-3.558E-3	-3.671E-3

43. Ilii_CS#

Ta = 25°C, Vcc = 3.3V, Vin = 0V

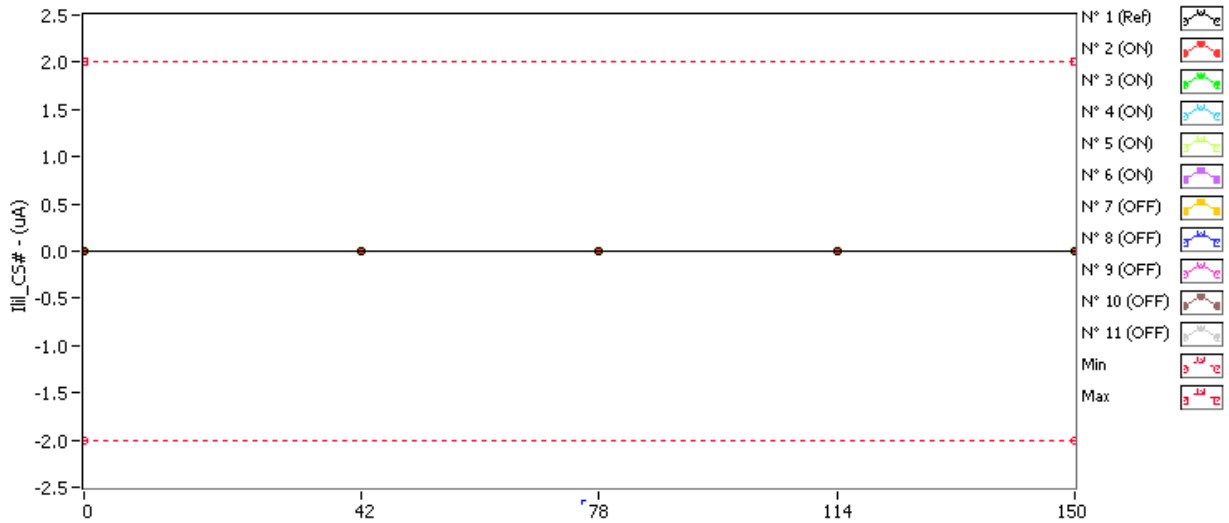

Ilii_CS# . (uA) Min = -2.0 Max = 2.0

	0krad(Si)	42krad(Si)	78krad(Si)	114krad(Si)	150krad(Si)
N° 1 (Ref)	7.040E-4	2.688E-3	1.467E-3	9.329E-4	1.085E-3
N° 2 (ON)	2.154E-3	7.803E-4	1.085E-3	2.306E-3	2.230E-3
N° 3 (ON)	5.514E-4	2.077E-3	1.009E-3	1.085E-3	7.803E-4
N° 4 (ON)	1.848E-3	2.459E-3	1.238E-3	8.566E-4	1.699E-4
N° 5 (ON)	3.988E-4	1.696E-3	4.751E-4	2.840E-3	1.314E-3
N° 6 (ON)	2.382E-3	2.993E-3	2.459E-3	1.009E-3	7.040E-4
N° 7 (OFF)	2.764E-3	5.514E-4	1.238E-3	2.764E-3	9.329E-4
N° 8 (OFF)	2.230E-3	1.543E-3	7.803E-4	2.230E-3	5.514E-4
N° 9 (OFF)	1.391E-3	1.238E-3	1.162E-3	2.459E-3	2.688E-3
N° 10 (OFF)	6.277E-4	7.803E-4	1.391E-3	1.848E-3	1.848E-3
N° 11 (OFF)	2.306E-3	1.238E-3	1.162E-3	9.329E-4	7.803E-4

Delta [Ilii_CS#]

	0krad(Si)	42krad(Si)	78krad(Si)	114krad(Si)	150krad(Si)
N° 1 (Ref)	---	1.984E-3	7.629E-4	2.289E-4	3.814E-4
N° 2 (ON)	---	-1.373E-3	-1.068E-3	1.526E-4	7.630E-5
N° 3 (ON)	---	1.526E-3	4.578E-4	5.340E-4	2.289E-4
N° 4 (ON)	---	6.103E-4	-6.104E-4	-9.918E-4	-1.678E-3
N° 5 (ON)	---	1.297E-3	7.630E-5	2.441E-3	9.155E-4
N° 6 (ON)	---	6.104E-4	7.630E-5	-1.373E-3	-1.678E-3
N° 7 (OFF)	---	-2.213E-3	-1.526E-3	0.000E+0	-1.831E-3
N° 8 (OFF)	---	-6.867E-4	-1.450E-3	0.000E+0	-1.679E-3
N° 9 (OFF)	---	-1.526E-4	-2.289E-4	1.068E-3	1.297E-3
N° 10 (OFF)	---	1.526E-4	7.629E-4	1.221E-3	1.221E-3
N° 11 (OFF)	---	-1.068E-3	-1.144E-3	-1.373E-3	-1.526E-3
Average (ON)	---	5.341E-4	-2.136E-4	1.526E-4	-4.272E-4
s (ON)	---	1.142E-3	6.137E-4	1.502E-3	1.185E-3
Average+3s (ON)	---	3.960E-3	1.628E-3	4.658E-3	3.128E-3
Average-3s (ON)	---	-2.892E-3	-2.055E-3	-4.353E-3	-3.983E-3
Average (OFF)	---	-7.935E-4	-7.172E-4	1.831E-4	-5.036E-4
s (OFF)	---	9.228E-4	9.750E-4	1.043E-3	1.613E-3
Average+3s (OFF)	---	1.975E-3	2.208E-3	3.311E-3	4.335E-3
Average-3s (OFF)	---	-3.562E-3	-3.642E-3	-2.945E-3	-5.342E-3

44. Ilii_OE#

Ta = 25°C, Vcc = 3.3V, Vin = 0V

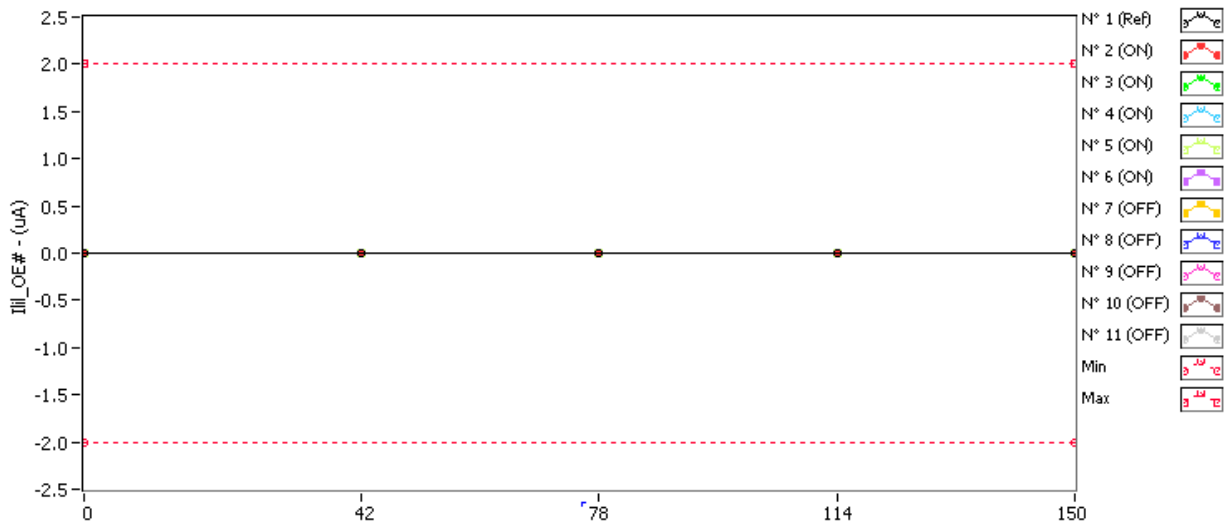

Ilii_OE# . (uA) Min = -2.0 Max = 2.0

	0krad(Si)	42krad(Si)	78krad(Si)	114krad(Si)	150krad(Si)
N° 1 (Ref)	1.467E-3	2.688E-3	2.840E-3	2.840E-3	1.467E-3
N° 2 (ON)	8.566E-4	3.374E-3	1.620E-3	2.535E-3	1.848E-3
N° 3 (ON)	2.306E-3	2.611E-3	1.467E-3	1.314E-3	1.848E-3
N° 4 (ON)	7.803E-4	2.077E-3	1.314E-3	3.145E-3	7.040E-4
N° 5 (ON)	4.751E-4	1.696E-3	2.459E-3	7.803E-4	6.277E-4
N° 6 (ON)	8.566E-4	1.696E-3	2.611E-3	2.916E-3	2.993E-3
N° 7 (OFF)	2.840E-3	1.391E-3	2.077E-3	2.459E-3	1.696E-3
N° 8 (OFF)	1.162E-3	3.145E-3	1.925E-3	2.382E-3	2.459E-3
N° 9 (OFF)	1.391E-3	2.306E-3	2.916E-3	1.620E-3	1.848E-3
N° 10 (OFF)	6.277E-4	1.314E-3	2.382E-3	2.154E-3	1.543E-3
N° 11 (OFF)	1.620E-3	1.314E-3	1.391E-3	1.238E-3	1.848E-3

Delta [Ilii_OE#]

	0krad(Si)	42krad(Si)	78krad(Si)	114krad(Si)	150krad(Si)
N° 1 (Ref)	---	1.221E-3	1.373E-3	1.373E-3	0.000E+0
N° 2 (ON)	---	2.518E-3	7.629E-4	1.678E-3	9.918E-4
N° 3 (ON)	---	3.051E-4	-8.393E-4	-9.919E-4	-4.578E-4
N° 4 (ON)	---	1.297E-3	5.340E-4	2.365E-3	-7.629E-5
N° 5 (ON)	---	1.221E-3	1.984E-3	3.052E-4	1.526E-4
N° 6 (ON)	---	8.392E-4	1.755E-3	2.060E-3	2.136E-3
N° 7 (OFF)	---	-1.450E-3	-7.629E-4	-3.815E-4	-1.144E-3
N° 8 (OFF)	---	1.984E-3	7.630E-4	1.221E-3	1.297E-3
N° 9 (OFF)	---	9.156E-4	1.526E-3	2.289E-4	4.578E-4
N° 10 (OFF)	---	6.866E-4	1.755E-3	1.526E-3	9.155E-4
N° 11 (OFF)	---	-3.052E-4	-2.289E-4	-3.815E-4	2.289E-4
Average (ON)	---	1.236E-3	8.392E-4	1.083E-3	5.493E-4
s (ON)	---	8.171E-4	1.125E-3	1.402E-3	1.034E-3
Average+3s (ON)	---	3.687E-3	4.215E-3	5.290E-3	3.652E-3
Average-3s (ON)	---	-1.215E-3	-2.536E-3	-3.123E-3	-2.553E-3
Average (OFF)	---	3.662E-4	6.104E-4	4.425E-4	3.510E-4
s (OFF)	---	1.301E-3	1.091E-3	8.920E-4	9.322E-4
Average+3s (OFF)	---	4.269E-3	3.883E-3	3.119E-3	3.148E-3
Average-3s (OFF)	---	-3.536E-3	-2.663E-3	-2.234E-3	-2.446E-3

45. Ilil_UB#

Ta = 25°C, Vcc = 3.3V, Vin = 0V

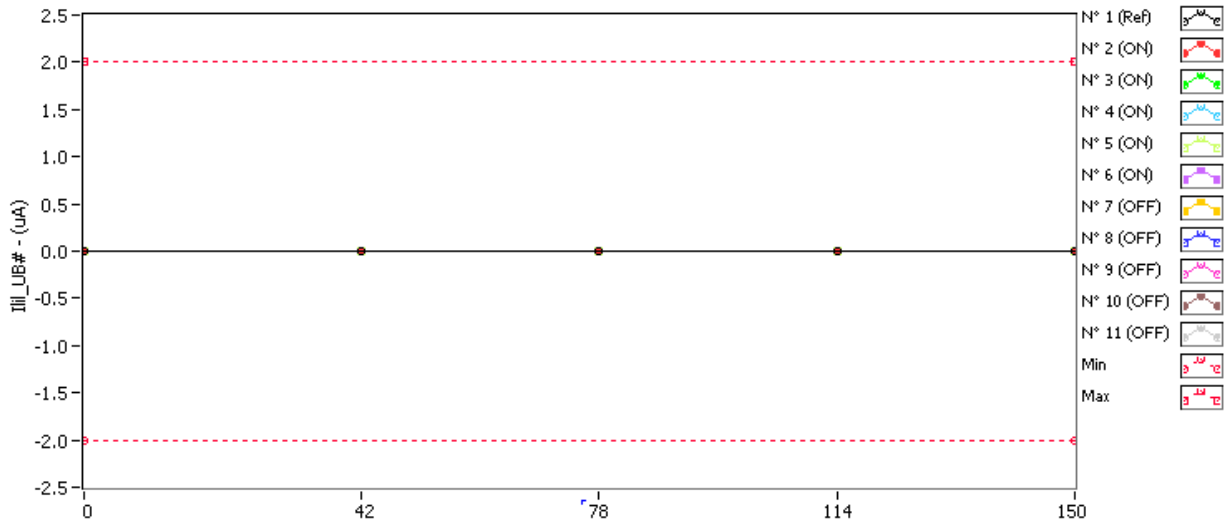

Ilil_UB# . (uA) Min = -2.0 Max = 2.0

	0krad(Si)	42krad(Si)	78krad(Si)	114krad(Si)	150krad(Si)
N° 1 (Ref)	1.848E-3	1.085E-3	1.314E-3	1.467E-3	1.543E-3
N° 2 (ON)	7.803E-4	2.306E-3	1.009E-3	1.620E-3	1.848E-3
N° 3 (ON)	3.222E-3	1.162E-3	1.162E-3	1.848E-3	9.329E-4
N° 4 (ON)	2.001E-3	2.306E-3	1.162E-3	1.848E-3	1.085E-3
N° 5 (ON)	2.611E-3	8.566E-4	1.925E-3	2.764E-3	1.085E-3
N° 6 (ON)	8.566E-4	1.009E-3	5.514E-4	1.314E-3	1.238E-3
N° 7 (OFF)	3.222E-3	1.391E-3	2.611E-3	1.391E-3	3.225E-4
N° 8 (OFF)	1.162E-3	2.230E-3	1.009E-3	3.145E-3	2.764E-3
N° 9 (OFF)	7.803E-4	1.009E-3	2.535E-3	2.688E-3	2.611E-3
N° 10 (OFF)	2.688E-3	1.772E-3	2.611E-3	8.566E-4	2.459E-3
N° 11 (OFF)	2.001E-3	4.751E-4	7.803E-4	2.306E-3	2.535E-3

Delta [Ilil_UB#]

	0krad(Si)	42krad(Si)	78krad(Si)	114krad(Si)	150krad(Si)
N° 1 (Ref)	---	-7.630E-4	-5.341E-4	-3.815E-4	-3.052E-4
N° 2 (ON)	---	1.526E-3	2.289E-4	8.392E-4	1.068E-3
N° 3 (ON)	---	-2.060E-3	-2.060E-3	-1.373E-3	-2.289E-3
N° 4 (ON)	---	3.052E-4	-8.393E-4	-1.526E-4	-9.156E-4
N° 5 (ON)	---	-1.755E-3	-6.866E-4	1.526E-4	-1.526E-3
N° 6 (ON)	---	1.526E-4	-3.052E-4	4.577E-4	3.814E-4
N° 7 (OFF)	---	-1.831E-3	-6.104E-4	-1.831E-3	-2.899E-3
N° 8 (OFF)	---	1.068E-3	-1.525E-4	1.984E-3	1.602E-3
N° 9 (OFF)	---	2.289E-4	1.755E-3	1.907E-3	1.831E-3
N° 10 (OFF)	---	-9.155E-4	-7.630E-5	-1.831E-3	-2.289E-4
N° 11 (OFF)	---	-1.526E-3	-1.221E-3	3.052E-4	5.340E-4
Average (ON)	---	-3.662E-4	-7.324E-4	-1.527E-5	-6.562E-4
s (ON)	---	1.508E-3	8.489E-4	8.434E-4	1.373E-3
Average+3s (ON)	---	4.158E-3	1.814E-3	2.515E-3	3.462E-3
Average-3s (ON)	---	-4.890E-3	-3.279E-3	-2.545E-3	-4.775E-3
Average (OFF)	---	-5.951E-4	-6.104E-5	1.068E-4	1.678E-4
s (OFF)	---	1.219E-3	1.113E-3	1.892E-3	1.905E-3
Average+3s (OFF)	---	3.061E-3	3.277E-3	5.782E-3	5.884E-3
Average-3s (OFF)	---	-4.252E-3	-3.399E-3	-5.568E-3	-5.548E-3

46. Ilii_LB#

Ta = 25°C, Vcc = 3.3V, Vin = 0V

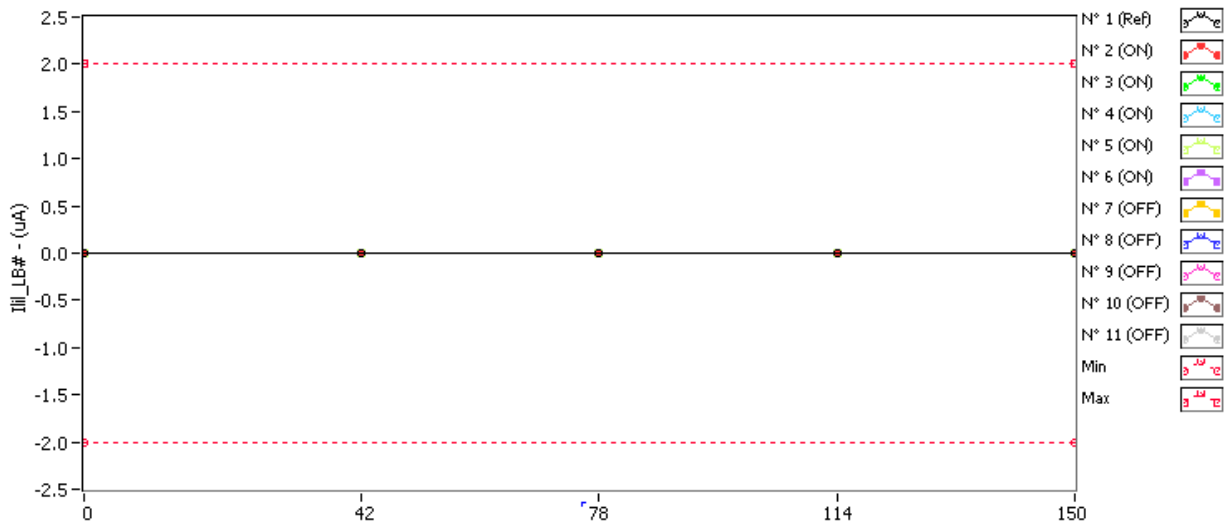

Ilii_LB# . (uA) Min = -2.0 Max = 2.0

	0krad(Si)	42krad(Si)	78krad(Si)	114krad(Si)	150krad(Si)
N° 1 (Ref)	7.803E-4	2.993E-3	2.764E-3	2.382E-3	2.459E-3
N° 2 (ON)	1.238E-3	2.382E-3	2.993E-3	2.611E-3	2.611E-3
N° 3 (ON)	2.840E-3	1.696E-3	2.764E-3	1.314E-3	2.688E-3
N° 4 (ON)	1.314E-3	2.688E-3	3.988E-4	9.329E-4	1.162E-3
N° 5 (ON)	2.764E-3	1.162E-3	2.154E-3	2.688E-3	1.696E-3
N° 6 (ON)	1.848E-3	2.993E-3	2.154E-3	1.391E-3	1.009E-3
N° 7 (OFF)	2.611E-3	1.848E-3	2.535E-3	2.535E-3	1.238E-3
N° 8 (OFF)	3.145E-3	2.993E-3	1.772E-3	2.382E-3	6.277E-4
N° 9 (OFF)	2.154E-3	1.620E-3	5.514E-4	1.009E-3	7.040E-4
N° 10 (OFF)	3.069E-3	1.162E-3	1.543E-3	2.382E-3	1.391E-3
N° 11 (OFF)	1.696E-3	1.467E-3	2.154E-3	7.040E-4	5.514E-4

Delta [Ilii_LB#]

	0krad(Si)	42krad(Si)	78krad(Si)	114krad(Si)	150krad(Si)
N° 1 (Ref)	---	2.213E-3	1.984E-3	1.602E-3	1.678E-3
N° 2 (ON)	---	1.144E-3	1.755E-3	1.373E-3	1.373E-3
N° 3 (ON)	---	-1.144E-3	-7.630E-5	-1.526E-3	-1.526E-4
N° 4 (ON)	---	1.373E-3	-9.155E-4	-3.814E-4	-1.526E-4
N° 5 (ON)	---	-1.602E-3	-6.103E-4	-7.630E-5	-1.068E-3
N° 6 (ON)	---	1.144E-3	3.052E-4	-4.578E-4	-8.392E-4
N° 7 (OFF)	---	-7.629E-4	-7.630E-5	-7.630E-5	-1.373E-3
N° 8 (OFF)	---	-1.526E-4	-1.373E-3	-7.630E-4	-2.518E-3
N° 9 (OFF)	---	-5.341E-4	-1.602E-3	-1.144E-3	-1.450E-3
N° 10 (OFF)	---	-1.907E-3	-1.526E-3	-6.867E-4	-1.678E-3
N° 11 (OFF)	---	-2.289E-4	4.578E-4	-9.918E-4	-1.144E-3
Average (ON)	---	1.831E-4	9.158E-5	-2.136E-4	-1.678E-4
s (ON)	---	1.433E-3	1.042E-3	1.042E-3	9.535E-4
Average+3s (ON)	---	4.482E-3	3.219E-3	2.914E-3	2.693E-3
Average-3s (ON)	---	-4.116E-3	-3.036E-3	-3.341E-3	-3.028E-3
Average (OFF)	---	-7.172E-4	-8.240E-4	-7.324E-4	-1.633E-3
s (OFF)	---	7.088E-4	9.490E-4	4.094E-4	5.302E-4
Average+3s (OFF)	---	1.409E-3	2.023E-3	4.958E-4	-4.202E-5
Average-3s (OFF)	---	-2.843E-3	-3.671E-3	-1.961E-3	-3.223E-3

47. Iloh_IO[0]

Ta = 25°C, Vcc = 3.3V, Vout = Vcc

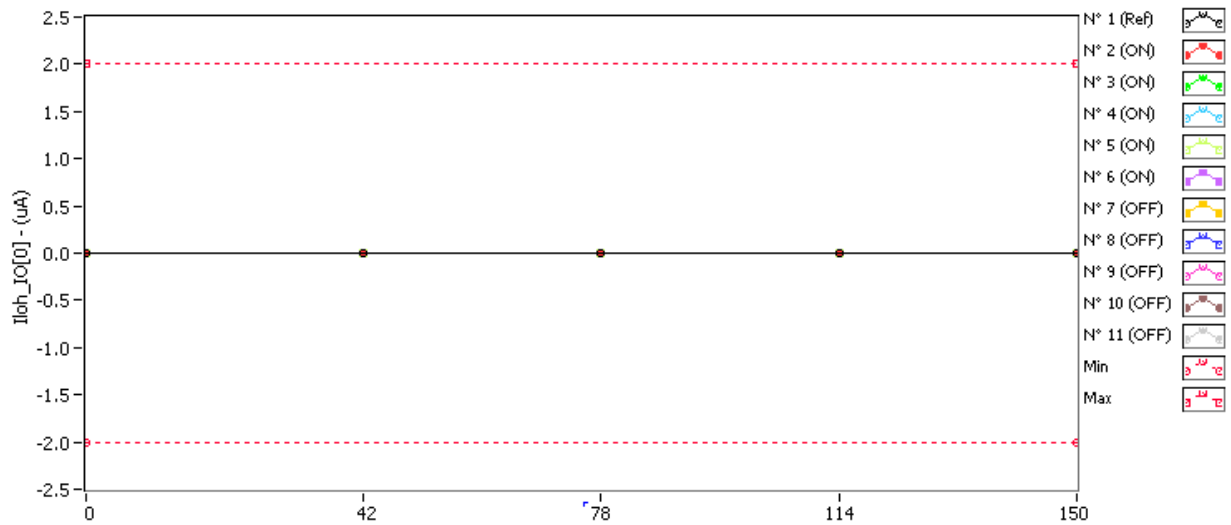

Iloh_IO[0] . (uA)

Min = -2.0 Max = 2.0

	0krad(Si)	42krad(Si)	78krad(Si)	114krad(Si)	150krad(Si)
N° 1 (Ref)	1.162E-3	3.527E-3	2.154E-3	1.391E-3	2.840E-3
N° 2 (ON)	3.298E-3	1.696E-3	1.620E-3	1.620E-3	2.306E-3
N° 3 (ON)	3.374E-3	1.467E-3	3.222E-3	2.459E-3	2.230E-3
N° 4 (ON)	2.306E-3	2.459E-3	3.222E-3	2.382E-3	1.009E-3
N° 5 (ON)	1.925E-3	2.459E-3	3.451E-3	1.772E-3	3.222E-3
N° 6 (ON)	2.001E-3	3.298E-3	2.916E-3	2.688E-3	2.535E-3
N° 7 (OFF)	2.459E-3	2.611E-3	2.764E-3	2.001E-3	1.314E-3
N° 8 (OFF)	2.535E-3	3.451E-3	3.527E-3	1.543E-3	1.696E-3
N° 9 (OFF)	1.467E-3	2.459E-3	2.535E-3	1.925E-3	2.382E-3
N° 10 (OFF)	3.374E-3	2.688E-3	1.543E-3	2.916E-3	3.222E-3
N° 11 (OFF)	2.840E-3	2.459E-3	3.985E-3	3.374E-3	2.688E-3

Delta [Iloh_IO[0]]

	0krad(Si)	42krad(Si)	78krad(Si)	114krad(Si)	150krad(Si)
N° 1 (Ref)	---	2.365E-3	9.919E-4	2.289E-4	1.679E-3
N° 2 (ON)	---	-1.602E-3	-1.679E-3	-1.679E-3	-9.918E-4
N° 3 (ON)	---	-1.907E-3	-1.526E-4	-9.156E-4	-1.144E-3
N° 4 (ON)	---	1.525E-4	9.155E-4	7.620E-5	-1.297E-3
N° 5 (ON)	---	5.340E-4	1.526E-3	-1.526E-4	1.297E-3
N° 6 (ON)	---	1.297E-3	9.155E-4	6.866E-4	5.340E-4
N° 7 (OFF)	---	1.526E-4	3.052E-4	-4.577E-4	-1.144E-3
N° 8 (OFF)	---	9.156E-4	9.919E-4	-9.918E-4	-8.392E-4
N° 9 (OFF)	---	9.918E-4	1.068E-3	4.578E-4	9.155E-4
N° 10 (OFF)	---	-6.867E-4	-1.831E-3	-4.578E-4	-1.526E-4
N° 11 (OFF)	---	-3.815E-4	1.144E-3	5.341E-4	-1.526E-4
Average (ON)	---	-3.052E-4	3.052E-4	-3.968E-4	-3.204E-4
s (ON)	---	1.390E-3	1.263E-3	9.177E-4	1.165E-3
Average+3s (ON)	---	3.865E-3	4.094E-3	2.356E-3	3.175E-3
Average-3s (ON)	---	-4.476E-3	-3.484E-3	-3.150E-3	-3.816E-3
Average (OFF)	---	1.984E-4	3.357E-4	-1.831E-4	-2.747E-4
s (OFF)	---	7.526E-4	1.257E-3	6.576E-4	7.940E-4
Average+3s (OFF)	---	2.456E-3	4.106E-3	1.790E-3	2.107E-3
Average-3s (OFF)	---	-2.059E-3	-3.434E-3	-2.156E-3	-2.657E-3

48. Iloh_IO[1]

Ta = 25°C, Vcc = 3.3V, Vout = Vcc

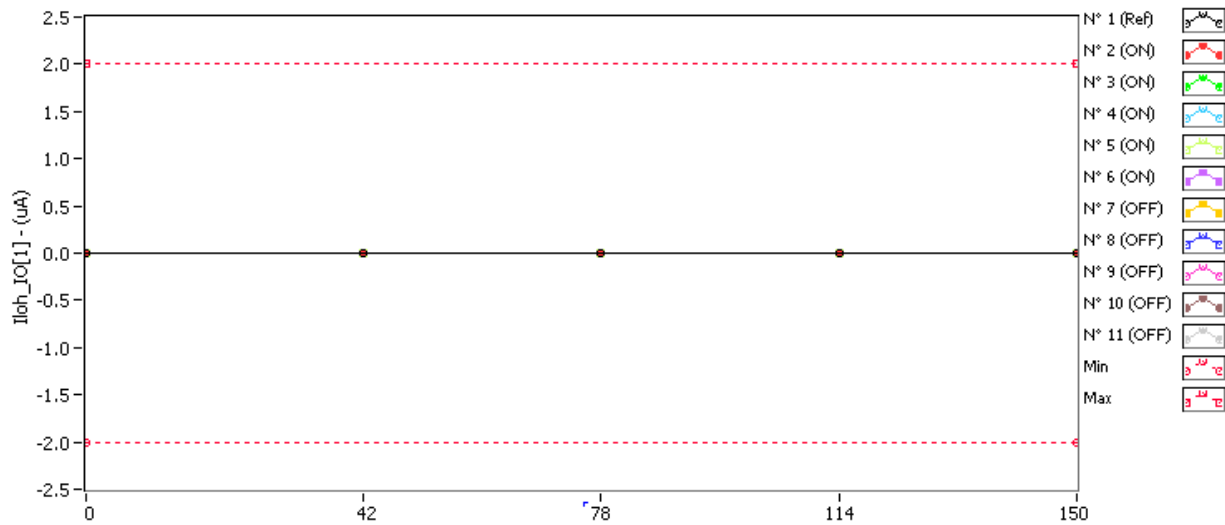

Iloh_IO[1] . (uA) Min = -2.0 Max = 2.0

	0krad(Si)	42krad(Si)	78krad(Si)	114krad(Si)	150krad(Si)
N° 1 (Ref)	1.848E-3	2.535E-3	2.611E-3	1.467E-3	2.001E-3
N° 2 (ON)	1.009E-3	2.077E-3	1.391E-3	2.993E-3	1.009E-3
N° 3 (ON)	2.001E-3	1.543E-3	2.306E-3	1.696E-3	1.238E-3
N° 4 (ON)	1.391E-3	2.382E-3	2.001E-3	3.222E-3	2.230E-3
N° 5 (ON)	1.009E-3	2.154E-3	2.154E-3	1.009E-3	2.306E-3
N° 6 (ON)	1.009E-3	2.688E-3	2.306E-3	1.543E-3	8.566E-4
N° 7 (OFF)	2.916E-3	1.848E-3	3.145E-3	1.085E-3	2.611E-3
N° 8 (OFF)	7.040E-4	2.306E-3	1.543E-3	2.916E-3	1.085E-3
N° 9 (OFF)	7.040E-4	2.306E-3	1.314E-3	9.329E-4	1.085E-3
N° 10 (OFF)	2.154E-3	1.314E-3	1.009E-3	1.238E-3	2.916E-3
N° 11 (OFF)	1.620E-3	1.467E-3	2.611E-3	1.848E-3	2.535E-3

Delta [Iloh_IO[1]]

	0krad(Si)	42krad(Si)	78krad(Si)	114krad(Si)	150krad(Si)
N° 1 (Ref)	---	6.866E-4	7.629E-4	-3.815E-4	1.526E-4
N° 2 (ON)	---	1.068E-3	3.814E-4	1.984E-3	0.000E+0
N° 3 (ON)	---	-4.578E-4	3.052E-4	-3.052E-4	-7.630E-4
N° 4 (ON)	---	9.918E-4	6.104E-4	1.831E-3	8.393E-4
N° 5 (ON)	---	1.144E-3	1.144E-3	0.000E+0	1.297E-3
N° 6 (ON)	---	1.678E-3	1.297E-3	5.340E-4	-1.526E-4
N° 7 (OFF)	---	-1.068E-3	2.289E-4	-1.831E-3	-3.052E-4
N° 8 (OFF)	---	1.602E-3	8.392E-4	2.213E-3	3.814E-4
N° 9 (OFF)	---	1.602E-3	6.103E-4	2.289E-4	3.814E-4
N° 10 (OFF)	---	-8.393E-4	-1.144E-3	-9.156E-4	7.629E-4
N° 11 (OFF)	---	-1.526E-4	9.918E-4	2.289E-4	9.155E-4
Average (ON)	---	8.850E-4	7.477E-4	8.087E-4	2.441E-4
s (ON)	---	7.976E-4	4.494E-4	1.048E-3	8.207E-4
Average+3s (ON)	---	3.278E-3	2.096E-3	3.954E-3	2.706E-3
Average-3s (ON)	---	-1.508E-3	-6.006E-4	-2.336E-3	-2.218E-3
Average (OFF)	---	2.289E-4	3.052E-4	-1.528E-5	4.272E-4
s (OFF)	---	1.298E-3	8.598E-4	1.516E-3	4.722E-4
Average+3s (OFF)	---	4.123E-3	2.884E-3	4.532E-3	1.844E-3
Average-3s (OFF)	---	-3.666E-3	-2.274E-3	-4.563E-3	-9.893E-4

49. Iloh_IO[2]

Ta = 25°C, Vcc = 3.3V, Vout = Vcc

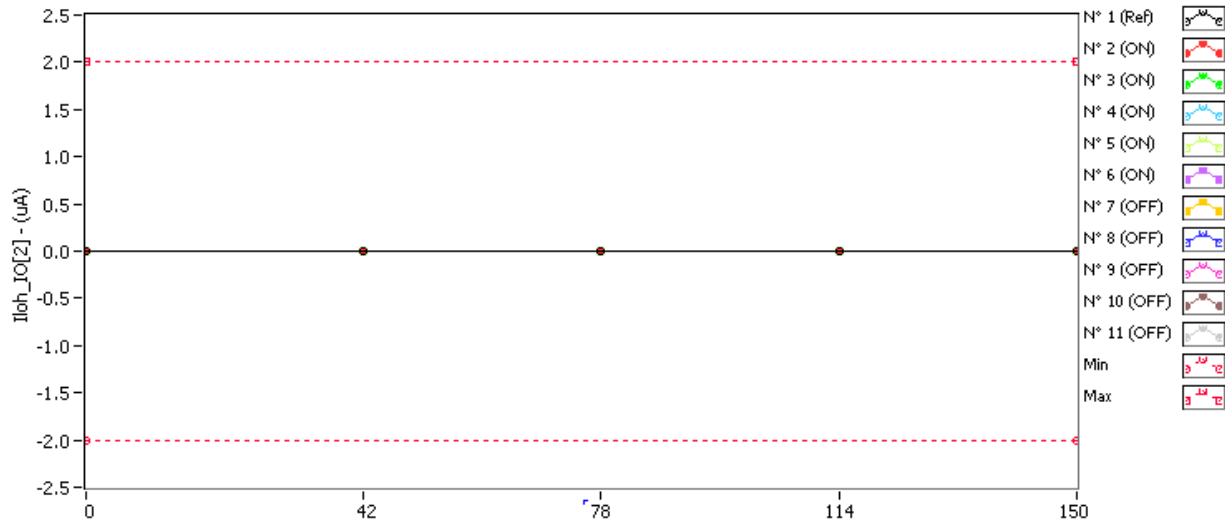

Iloh_IO[2] . (uA) Min = -2.0 Max = 2.0

	0krad(Si)	42krad(Si)	78krad(Si)	114krad(Si)	150krad(Si)
N° 1 (Ref)	2.306E-3	9.329E-4	1.772E-3	2.306E-3	1.162E-3
N° 2 (ON)	2.764E-3	1.162E-3	1.772E-3	3.374E-3	1.772E-3
N° 3 (ON)	1.543E-3	2.230E-3	2.535E-3	3.222E-3	2.840E-3
N° 4 (ON)	2.230E-3	2.840E-3	1.467E-3	1.620E-3	2.077E-3
N° 5 (ON)	2.764E-3	2.840E-3	1.391E-3	2.306E-3	2.764E-3
N° 6 (ON)	2.611E-3	2.993E-3	2.230E-3	3.069E-3	1.009E-3
N° 7 (OFF)	1.009E-3	2.535E-3	1.620E-3	2.535E-3	2.993E-3
N° 8 (OFF)	1.009E-3	1.391E-3	1.162E-3	1.314E-3	2.535E-3
N° 9 (OFF)	2.764E-3	2.840E-3	1.467E-3	1.238E-3	1.696E-3
N° 10 (OFF)	2.611E-3	2.611E-3	1.391E-3	1.543E-3	1.772E-3
N° 11 (OFF)	1.848E-3	1.696E-3	3.298E-3	2.764E-3	8.566E-4

Delta [Iloh_IO[2]]

	0krad(Si)	42krad(Si)	78krad(Si)	114krad(Si)	150krad(Si)
N° 1 (Ref)	---	-1.373E-3	-5.341E-4	0.000E+0	-1.144E-3
N° 2 (ON)	---	-1.602E-3	-9.918E-4	6.104E-4	-9.918E-4
N° 3 (ON)	---	6.867E-4	9.918E-4	1.679E-3	1.297E-3
N° 4 (ON)	---	6.103E-4	-7.630E-4	-6.104E-4	-1.526E-4
N° 5 (ON)	---	7.630E-5	-1.373E-3	-4.577E-4	0.000E+0
N° 6 (ON)	---	3.815E-4	-3.814E-4	4.578E-4	-1.602E-3
N° 7 (OFF)	---	1.526E-3	6.103E-4	1.526E-3	1.984E-3
N° 8 (OFF)	---	3.814E-4	1.525E-4	3.051E-4	1.526E-3
N° 9 (OFF)	---	7.630E-5	-1.297E-3	-1.526E-3	-1.068E-3
N° 10 (OFF)	---	0.000E+0	-1.221E-3	-1.068E-3	-8.392E-4
N° 11 (OFF)	---	-1.526E-4	1.450E-3	9.155E-4	-9.918E-4
Average (ON)	---	3.052E-5	-5.035E-4	3.357E-4	-2.899E-4
s (ON)	---	9.431E-4	9.101E-4	9.244E-4	1.100E-3
Average+3s (ON)	---	2.860E-3	2.227E-3	3.109E-3	3.009E-3
Average-3s (ON)	---	-2.799E-3	-3.234E-3	-2.437E-3	-3.588E-3
Average (OFF)	---	3.662E-4	-6.106E-5	3.048E-5	1.221E-4
s (OFF)	---	6.768E-4	1.189E-3	1.297E-3	1.501E-3
Average+3s (OFF)	---	2.397E-3	3.505E-3	3.920E-3	4.626E-3
Average-3s (OFF)	---	-1.664E-3	-3.627E-3	-3.859E-3	-4.382E-3

50. Iloh_IO[3]

Ta = 25°C, Vcc = 3.3V, Vout = Vcc

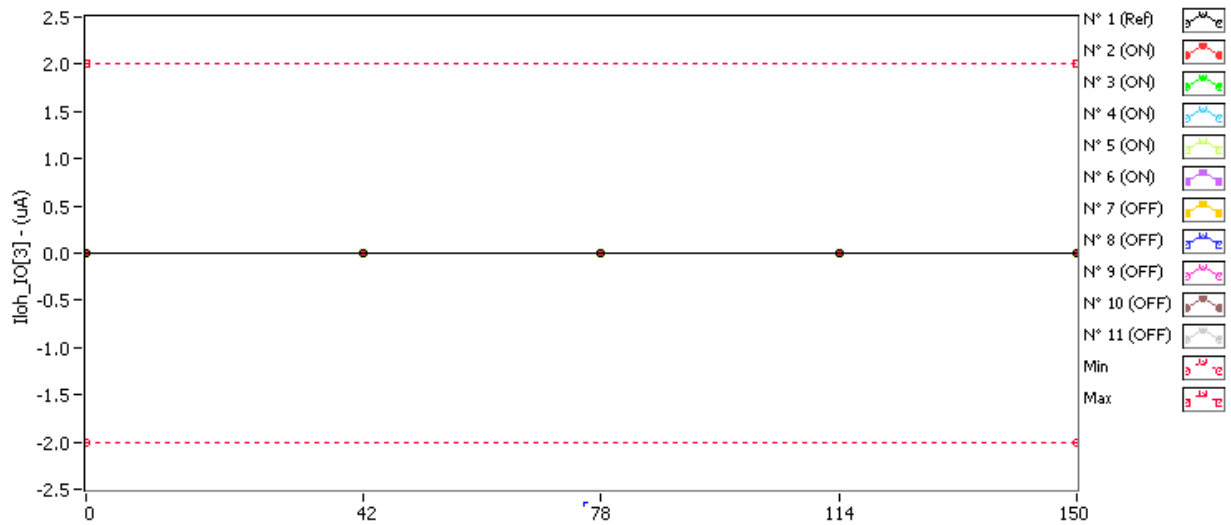

Iloh_IO[3] . (uA) Min = -2.0 Max = 2.0

	0krad(Si)	42krad(Si)	78krad(Si)	114krad(Si)	150krad(Si)
N° 1 (Ref)	7.040E-4	1.085E-3	1.238E-3	2.535E-3	6.277E-4
N° 2 (ON)	1.772E-3	1.772E-3	1.162E-3	2.382E-3	1.696E-3
N° 3 (ON)	1.848E-3	2.077E-3	1.162E-3	2.001E-3	7.040E-4
N° 4 (ON)	1.314E-3	2.154E-3	1.314E-3	7.040E-4	2.459E-3
N° 5 (ON)	2.154E-3	1.925E-3	2.840E-3	1.009E-3	1.314E-3
N° 6 (ON)	2.459E-3	5.514E-4	2.306E-3	2.230E-3	2.382E-3
N° 7 (OFF)	2.459E-3	2.382E-3	2.688E-3	1.314E-3	2.230E-3
N° 8 (OFF)	6.277E-4	1.620E-3	1.162E-3	2.001E-3	1.620E-3
N° 9 (OFF)	2.230E-3	1.696E-3	2.154E-3	2.382E-3	1.391E-3
N° 10 (OFF)	2.077E-3	2.077E-3	8.566E-4	8.566E-4	9.329E-4
N° 11 (OFF)	1.696E-3	2.001E-3	1.772E-3	2.154E-3	1.162E-3

Delta [Iloh_IO[3]]

	0krad(Si)	42krad(Si)	78krad(Si)	114krad(Si)	150krad(Si)
N° 1 (Ref)	---	3.814E-4	5.340E-4	1.831E-3	-7.629E-5
N° 2 (ON)	---	0.000E+0	-6.104E-4	6.103E-4	-7.630E-5
N° 3 (ON)	---	2.289E-4	-6.867E-4	1.526E-4	-1.144E-3
N° 4 (ON)	---	8.393E-4	0.000E+0	-6.103E-4	1.144E-3
N° 5 (ON)	---	-2.289E-4	6.866E-4	-1.144E-3	-8.393E-4
N° 6 (ON)	---	-1.907E-3	-1.525E-4	-2.288E-4	-7.630E-5
N° 7 (OFF)	---	-7.630E-5	2.289E-4	-1.144E-3	-2.288E-4
N° 8 (OFF)	---	9.918E-4	5.340E-4	1.373E-3	9.918E-4
N° 9 (OFF)	---	-5.341E-4	-7.630E-5	1.525E-4	-8.393E-4
N° 10 (OFF)	---	0.000E+0	-1.221E-3	-1.221E-3	-1.144E-3
N° 11 (OFF)	---	3.052E-4	7.630E-5	4.578E-4	-5.341E-4
Average (ON)	---	-2.136E-4	-1.526E-4	-2.441E-4	-1.984E-4
s (ON)	---	1.027E-3	5.528E-4	6.768E-4	8.858E-4
Average+3s (ON)	---	2.867E-3	1.506E-3	1.786E-3	2.459E-3
Average-3s (ON)	---	-3.295E-3	-1.811E-3	-2.275E-3	-2.856E-3
Average (OFF)	---	1.373E-4	-9.156E-5	-7.630E-5	-3.510E-4
s (OFF)	---	5.643E-4	6.703E-4	1.106E-3	8.246E-4
Average+3s (OFF)	---	1.830E-3	1.919E-3	3.241E-3	2.123E-3
Average-3s (OFF)	---	-1.556E-3	-2.103E-3	-3.393E-3	-2.825E-3

51. Iloh_IO[4]

Ta = 25°C, Vcc = 3.3V, Vout = Vcc

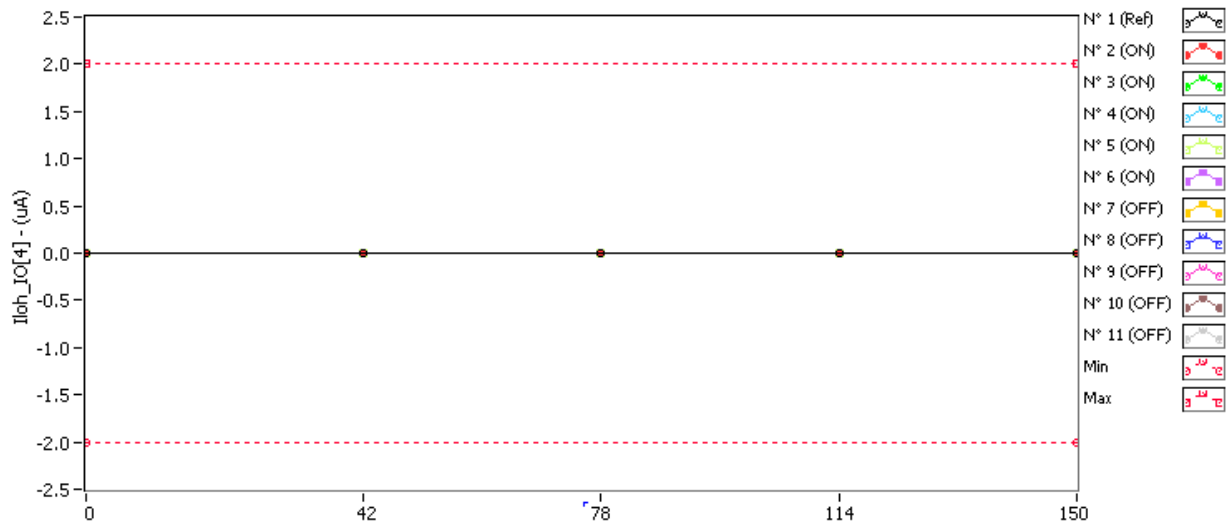

Iloh_IO[4] . (uA) Min = -2.0 Max = 2.0

	0krad(Si)	42krad(Si)	78krad(Si)	114krad(Si)	150krad(Si)
N° 1 (Ref)	1.543E-3	2.382E-3	1.696E-3	1.620E-3	3.069E-3
N° 2 (ON)	9.329E-4	2.611E-3	1.467E-3	1.620E-3	2.230E-3
N° 3 (ON)	2.154E-3	3.069E-3	2.840E-3	1.696E-3	2.230E-3
N° 4 (ON)	1.696E-3	2.688E-3	1.314E-3	1.009E-3	2.459E-3
N° 5 (ON)	2.688E-3	2.306E-3	3.069E-3	2.916E-3	1.772E-3
N° 6 (ON)	2.001E-3	1.925E-3	1.543E-3	2.535E-3	3.069E-3
N° 7 (OFF)	2.077E-3	3.145E-3	2.764E-3	2.230E-3	1.848E-3
N° 8 (OFF)	1.085E-3	1.848E-3	1.391E-3	1.238E-3	2.382E-3
N° 9 (OFF)	3.069E-3	3.069E-3	1.543E-3	2.077E-3	2.306E-3
N° 10 (OFF)	1.314E-3	2.916E-3	1.467E-3	2.916E-3	2.459E-3
N° 11 (OFF)	1.925E-3	2.306E-3	1.467E-3	8.566E-4	1.772E-3

Delta [Iloh_IO[4]]

	0krad(Si)	42krad(Si)	78krad(Si)	114krad(Si)	150krad(Si)
N° 1 (Ref)	---	8.392E-4	1.526E-4	7.630E-5	1.526E-3
N° 2 (ON)	---	1.678E-3	5.340E-4	6.866E-4	1.297E-3
N° 3 (ON)	---	9.155E-4	6.866E-4	-4.578E-4	7.630E-5
N° 4 (ON)	---	9.918E-4	-3.815E-4	-6.866E-4	7.629E-4
N° 5 (ON)	---	-3.814E-4	3.815E-4	2.289E-4	-9.155E-4
N° 6 (ON)	---	-7.630E-5	-4.578E-4	5.340E-4	1.068E-3
N° 7 (OFF)	---	1.068E-3	6.866E-4	1.526E-4	-2.289E-4
N° 8 (OFF)	---	7.630E-4	3.052E-4	1.526E-4	1.297E-3
N° 9 (OFF)	---	0.000E+0	-1.526E-3	-9.918E-4	-7.629E-4
N° 10 (OFF)	---	1.602E-3	1.526E-4	1.602E-3	1.144E-3
N° 11 (OFF)	---	3.815E-4	-4.578E-4	-1.068E-3	-1.526E-4
Average (ON)	---	6.256E-4	1.526E-4	6.103E-4	4.578E-4
s (ON)	---	8.416E-4	5.341E-4	6.065E-4	8.946E-4
Average+3s (ON)	---	3.150E-3	1.755E-3	1.881E-3	3.142E-3
Average-3s (ON)	---	-1.899E-3	-1.450E-3	-1.758E-3	-2.226E-3
Average (OFF)	---	7.630E-4	-1.679E-4	-3.051E-5	2.594E-4
s (OFF)	---	6.175E-4	8.638E-4	1.088E-3	9.101E-4
Average+3s (OFF)	---	2.615E-3	2.424E-3	3.233E-3	2.990E-3
Average-3s (OFF)	---	-1.089E-3	-2.759E-3	-3.294E-3	-2.471E-3

52. Iloh_IO[5]

Ta = 25°C, Vcc = 3.3V, Vout = Vcc

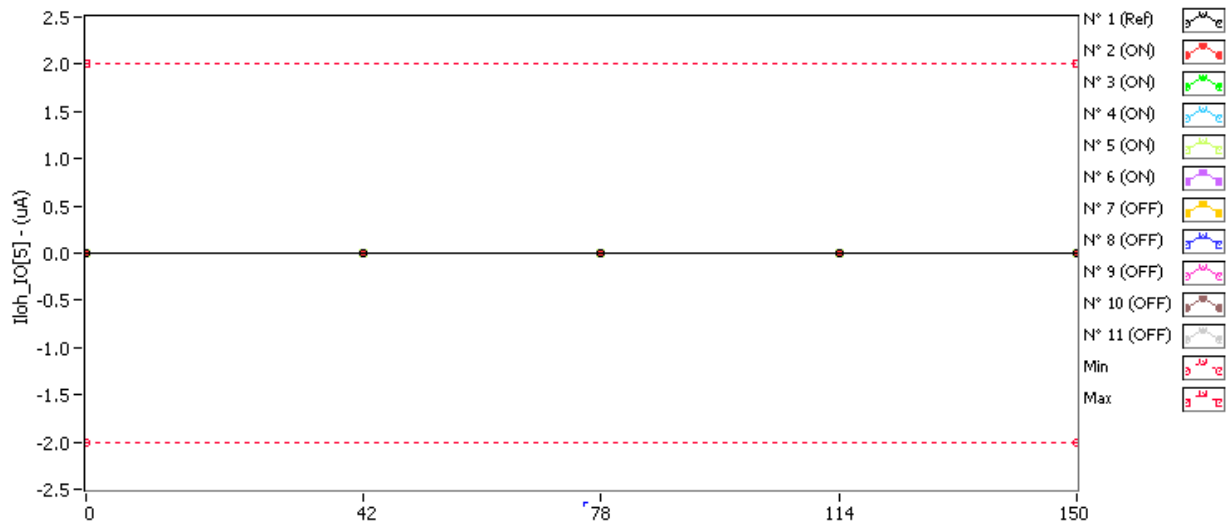

Iloh_IO[5] . (uA) Min = -2.0 Max = 2.0

	0krad(Si)	42krad(Si)	78krad(Si)	114krad(Si)	150krad(Si)
N° 1 (Ref)	8.566E-4	1.696E-3	2.459E-3	5.514E-4	2.077E-3
N° 2 (ON)	2.382E-3	1.085E-3	2.459E-3	6.277E-4	2.916E-3
N° 3 (ON)	1.620E-3	1.543E-3	2.001E-3	1.696E-3	3.451E-3
N° 4 (ON)	1.467E-3	1.391E-3	2.077E-3	2.688E-3	2.993E-3
N° 5 (ON)	2.611E-3	2.154E-3	1.772E-3	2.688E-3	1.772E-3
N° 6 (ON)	2.154E-3	1.620E-3	1.925E-3	2.382E-3	2.764E-3
N° 7 (OFF)	7.040E-4	1.162E-3	1.925E-3	2.154E-3	2.077E-3
N° 8 (OFF)	1.620E-3	1.391E-3	1.238E-3	1.162E-3	1.162E-3
N° 9 (OFF)	2.459E-3	2.230E-3	1.620E-3	1.162E-3	2.916E-3
N° 10 (OFF)	1.391E-3	1.696E-3	2.382E-3	2.077E-3	2.840E-3
N° 11 (OFF)	2.611E-3	1.391E-3	2.459E-3	2.382E-3	2.688E-3

Delta [Iloh_IO[5]]

	0krad(Si)	42krad(Si)	78krad(Si)	114krad(Si)	150krad(Si)
N° 1 (Ref)	---	8.392E-4	1.602E-3	-3.052E-4	1.221E-3
N° 2 (ON)	---	-1.297E-3	7.630E-5	-1.755E-3	5.341E-4
N° 3 (ON)	---	-7.630E-5	3.815E-4	7.630E-5	1.831E-3
N° 4 (ON)	---	-7.630E-5	6.104E-4	1.221E-3	1.526E-3
N° 5 (ON)	---	-4.577E-4	-8.392E-4	7.630E-5	-8.392E-4
N° 6 (ON)	---	-5.341E-4	-2.289E-4	2.288E-4	6.103E-4
N° 7 (OFF)	---	4.577E-4	1.221E-3	1.450E-3	1.373E-3
N° 8 (OFF)	---	-2.289E-4	-3.815E-4	-4.578E-4	-4.578E-4
N° 9 (OFF)	---	-2.288E-4	-8.392E-4	-1.297E-3	4.578E-4
N° 10 (OFF)	---	3.052E-4	9.918E-4	6.867E-4	1.450E-3
N° 11 (OFF)	---	-1.221E-3	-1.526E-4	-2.289E-4	7.630E-5
Average (ON)	---	-4.883E-4	2.000E-8	-3.052E-5	7.324E-4
s (ON)	---	4.991E-4	5.658E-4	1.076E-3	1.044E-3
Average+3s (ON)	---	1.009E-3	1.697E-3	3.197E-3	3.865E-3
Average-3s (ON)	---	-1.986E-3	-1.697E-3	-3.258E-3	-2.400E-3
Average (OFF)	---	-1.831E-4	1.678E-4	3.052E-5	5.798E-4
s (OFF)	---	6.576E-4	8.953E-4	1.062E-3	8.263E-4
Average+3s (OFF)	---	1.790E-3	2.854E-3	3.217E-3	3.059E-3
Average-3s (OFF)	---	-2.156E-3	-2.518E-3	-3.156E-3	-1.899E-3

53. Iloh_IO[6]

Ta = 25°C, Vcc = 3.3V, Vout = Vcc

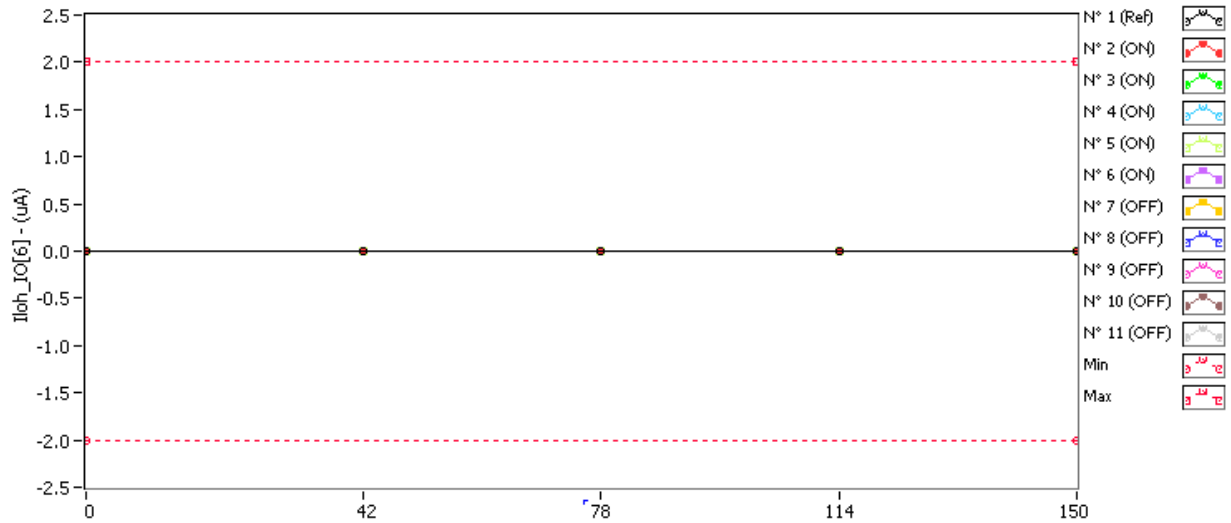

Iloh_IO[6] . (uA) Min = -2.0 Max = 2.0

	0krad(Si)	42krad(Si)	78krad(Si)	114krad(Si)	150krad(Si)
N° 1 (Ref)	1.620E-3	3.679E-3	3.451E-3	2.459E-3	2.688E-3
N° 2 (ON)	3.145E-3	3.832E-3	3.985E-3	2.001E-3	2.916E-3
N° 3 (ON)	2.382E-3	2.916E-3	4.061E-3	1.772E-3	2.840E-3
N° 4 (ON)	2.611E-3	2.382E-3	2.611E-3	3.069E-3	1.848E-3
N° 5 (ON)	3.527E-3	3.222E-3	2.916E-3	1.467E-3	2.077E-3
N° 6 (ON)	3.756E-3	1.543E-3	3.679E-3	2.382E-3	2.459E-3
N° 7 (OFF)	2.154E-3	2.535E-3	2.306E-3	2.382E-3	2.688E-3
N° 8 (OFF)	2.077E-3	2.306E-3	2.993E-3	3.679E-3	3.832E-3
N° 9 (OFF)	4.214E-3	2.459E-3	2.916E-3	2.382E-3	1.162E-3
N° 10 (OFF)	3.222E-3	2.688E-3	3.451E-3	2.382E-3	2.764E-3
N° 11 (OFF)	2.764E-3	3.527E-3	3.451E-3	3.222E-3	2.688E-3

Delta [Iloh_IO[6]]

	0krad(Si)	42krad(Si)	78krad(Si)	114krad(Si)	150krad(Si)
N° 1 (Ref)	---	2.060E-3	1.831E-3	8.392E-4	1.068E-3
N° 2 (ON)	---	6.866E-4	8.392E-4	-1.144E-3	-2.289E-4
N° 3 (ON)	---	5.341E-4	1.679E-3	-6.103E-4	4.578E-4
N° 4 (ON)	---	-2.289E-4	0.000E+0	4.578E-4	-7.629E-4
N° 5 (ON)	---	-3.052E-4	-6.104E-4	-2.060E-3	-1.450E-3
N° 6 (ON)	---	-2.213E-3	-7.630E-5	-1.373E-3	-1.297E-3
N° 7 (OFF)	---	3.814E-4	1.526E-4	2.288E-4	5.340E-4
N° 8 (OFF)	---	2.289E-4	9.155E-4	1.602E-3	1.755E-3
N° 9 (OFF)	---	-1.755E-3	-1.297E-3	-1.831E-3	-3.052E-3
N° 10 (OFF)	---	-5.341E-4	2.289E-4	-8.393E-4	-4.578E-4
N° 11 (OFF)	---	7.630E-4	6.867E-4	4.578E-4	-7.630E-5
Average (ON)	---	-3.052E-4	3.662E-4	-9.460E-4	-6.561E-4
s (ON)	---	1.155E-3	8.985E-4	9.416E-4	7.866E-4
Average+3s (ON)	---	3.158E-3	3.062E-3	1.879E-3	1.704E-3
Average-3s (ON)	---	-3.769E-3	-2.329E-3	-3.771E-3	-3.016E-3
Average (OFF)	---	-1.831E-4	1.373E-4	-7.634E-5	-2.594E-4
s (OFF)	---	9.971E-4	8.622E-4	1.309E-3	1.772E-3
Average+3s (OFF)	---	2.808E-3	2.724E-3	3.852E-3	5.056E-3
Average-3s (OFF)	---	-3.174E-3	-2.449E-3	-4.004E-3	-5.575E-3

54. Iloh_IO[7]

Ta = 25°C, Vcc = 3.3V, Vout = Vcc

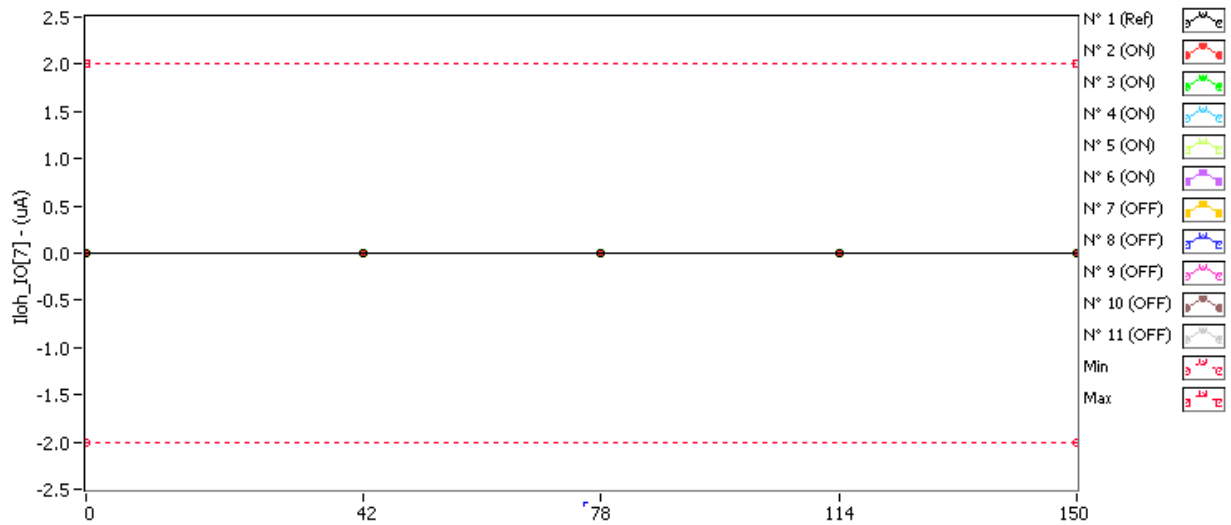

Iloh_IO[7] . (uA) Min = -2.0 Max = 2.0

	0krad(Si)	42krad(Si)	78krad(Si)	114krad(Si)	150krad(Si)
N° 1 (Ref)	2.916E-3	3.298E-3	3.527E-3	1.238E-3	2.001E-3
N° 2 (ON)	3.145E-3	3.069E-3	3.069E-3	2.916E-3	1.620E-3
N° 3 (ON)	2.840E-3	3.069E-3	1.848E-3	1.925E-3	2.535E-3
N° 4 (ON)	2.993E-3	3.298E-3	3.374E-3	1.162E-3	2.611E-3
N° 5 (ON)	3.374E-3	2.077E-3	1.543E-3	7.040E-4	1.314E-3
N° 6 (ON)	2.764E-3	2.459E-3	1.238E-3	2.993E-3	3.832E-3
N° 7 (OFF)	2.840E-3	2.688E-3	3.679E-3	2.688E-3	3.451E-3
N° 8 (OFF)	2.230E-3	3.374E-3	2.993E-3	2.535E-3	1.772E-3
N° 9 (OFF)	2.688E-3	1.620E-3	1.925E-3	2.459E-3	1.543E-3
N° 10 (OFF)	3.145E-3	2.306E-3	3.222E-3	3.298E-3	2.230E-3
N° 11 (OFF)	3.374E-3	2.688E-3	1.848E-3	1.162E-3	1.696E-3

Delta [Iloh_IO[7]]

	0krad(Si)	42krad(Si)	78krad(Si)	114krad(Si)	150krad(Si)
N° 1 (Ref)	---	3.815E-4	6.104E-4	-1.678E-3	-9.155E-4
N° 2 (ON)	---	-7.630E-5	-7.630E-5	-2.289E-4	-1.526E-3
N° 3 (ON)	---	2.289E-4	-9.918E-4	-9.155E-4	-3.052E-4
N° 4 (ON)	---	3.052E-4	3.815E-4	-1.831E-3	-3.815E-4
N° 5 (ON)	---	-1.297E-3	-1.831E-3	-2.670E-3	-2.060E-3
N° 6 (ON)	---	-3.052E-4	-1.526E-3	2.289E-4	1.068E-3
N° 7 (OFF)	---	-1.526E-4	8.392E-4	-1.526E-4	6.104E-4
N° 8 (OFF)	---	1.144E-3	7.629E-4	3.051E-4	-4.578E-4
N° 9 (OFF)	---	-1.068E-3	-7.629E-4	-2.289E-4	-1.144E-3
N° 10 (OFF)	---	-8.392E-4	7.630E-5	1.526E-4	-9.155E-4
N° 11 (OFF)	---	-6.867E-4	-1.526E-3	-2.213E-3	-1.679E-3
Average (ON)	---	-2.289E-4	-8.087E-4	-1.083E-3	-6.409E-4
s (ON)	---	6.451E-4	9.416E-4	1.179E-3	1.214E-3
Average+3s (ON)	---	1.707E-3	2.016E-3	2.453E-3	3.002E-3
Average-3s (ON)	---	-2.164E-3	-3.633E-3	-4.620E-3	-4.284E-3
Average (OFF)	---	-3.204E-4	-1.221E-4	-4.273E-4	-7.172E-4
s (OFF)	---	8.855E-4	1.016E-3	1.022E-3	8.625E-4
Average+3s (OFF)	---	2.336E-3	2.926E-3	2.638E-3	1.870E-3
Average-3s (OFF)	---	-2.977E-3	-3.170E-3	-3.492E-3	-3.305E-3

55. Iloh_IO[8]

Ta = 25°C, Vcc = 3.3V, Vout = Vcc

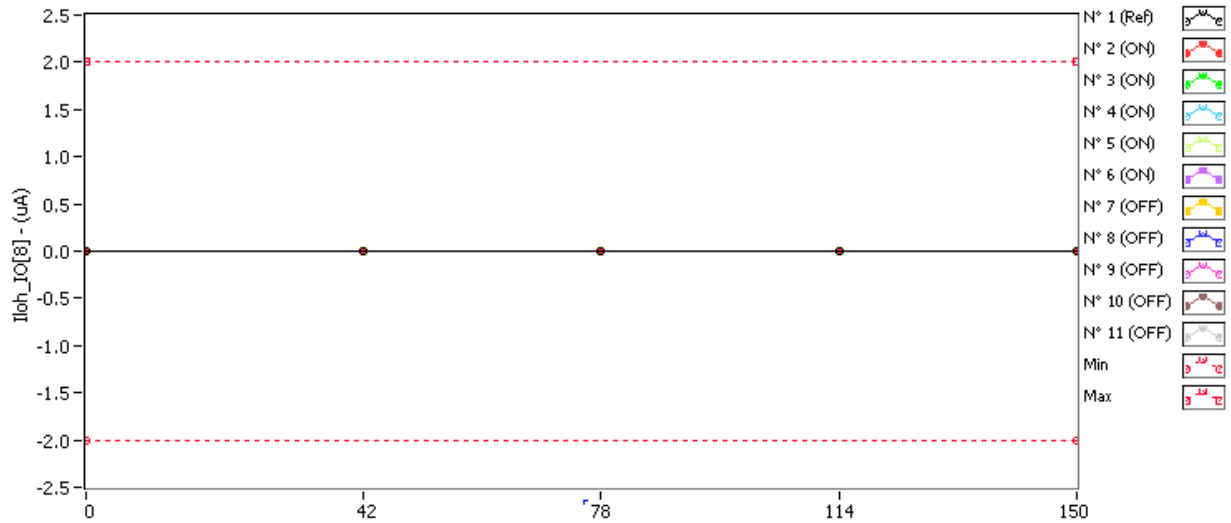

Iloh_IO[8] . (uA) Min = -2.0 Max = 2.0

	0krad(Si)	42krad(Si)	78krad(Si)	114krad(Si)	150krad(Si)
N° 1 (Ref)	2.840E-3	8.566E-4	2.840E-3	3.069E-3	2.916E-3
N° 2 (ON)	1.238E-3	1.085E-3	2.154E-3	2.840E-3	2.611E-3
N° 3 (ON)	2.688E-3	1.925E-3	2.688E-3	2.916E-3	1.772E-3
N° 4 (ON)	2.916E-3	2.535E-3	1.848E-3	2.993E-3	2.459E-3
N° 5 (ON)	2.001E-3	1.620E-3	2.993E-3	1.391E-3	2.382E-3
N° 6 (ON)	1.238E-3	2.001E-3	2.840E-3	1.314E-3	1.848E-3
N° 7 (OFF)	1.543E-3	2.230E-3	2.611E-3	1.467E-3	1.238E-3
N° 8 (OFF)	1.314E-3	2.611E-3	2.916E-3	1.772E-3	2.688E-3
N° 9 (OFF)	1.314E-3	1.925E-3	2.764E-3	2.382E-3	2.154E-3
N° 10 (OFF)	1.620E-3	2.459E-3	2.764E-3	1.543E-3	2.230E-3
N° 11 (OFF)	2.916E-3	1.162E-3	2.535E-3	2.077E-3	1.696E-3

Delta [Iloh_IO[8]]

	0krad(Si)	42krad(Si)	78krad(Si)	114krad(Si)	150krad(Si)
N° 1 (Ref)	---	-1.984E-3	0.000E+0	2.289E-4	7.630E-5
N° 2 (ON)	---	-1.526E-4	9.156E-4	1.602E-3	1.373E-3
N° 3 (ON)	---	-7.629E-4	0.000E+0	2.289E-4	-9.155E-4
N° 4 (ON)	---	-3.815E-4	-1.068E-3	7.630E-5	-4.578E-4
N° 5 (ON)	---	-3.815E-4	9.918E-4	-6.104E-4	3.814E-4
N° 6 (ON)	---	7.630E-4	1.602E-3	7.630E-5	6.104E-4
N° 7 (OFF)	---	6.867E-4	1.068E-3	-7.630E-5	-3.052E-4
N° 8 (OFF)	---	1.297E-3	1.602E-3	4.578E-4	1.373E-3
N° 9 (OFF)	---	6.104E-4	1.450E-3	1.068E-3	8.393E-4
N° 10 (OFF)	---	8.392E-4	1.144E-3	-7.630E-5	6.104E-4
N° 11 (OFF)	---	-1.755E-3	-3.815E-4	-8.392E-4	-1.221E-3
Average (ON)	---	-1.831E-4	4.883E-4	2.747E-4	1.984E-4
s (ON)	---	5.725E-4	1.041E-3	8.103E-4	9.021E-4
Average+3s (ON)	---	1.534E-3	3.612E-3	2.706E-3	2.905E-3
Average-3s (ON)	---	-1.901E-3	-2.636E-3	-2.156E-3	-2.508E-3
Average (OFF)	---	3.357E-4	9.766E-4	1.068E-4	2.594E-4
s (OFF)	---	1.199E-3	7.899E-4	7.087E-4	1.026E-3
Average+3s (OFF)	---	3.931E-3	3.346E-3	2.233E-3	3.337E-3
Average-3s (OFF)	---	-3.260E-3	-1.393E-3	-2.019E-3	-2.818E-3

56. Iloh_IO[9]

Ta = 25°C, Vcc = 3.3V, Vout = Vcc

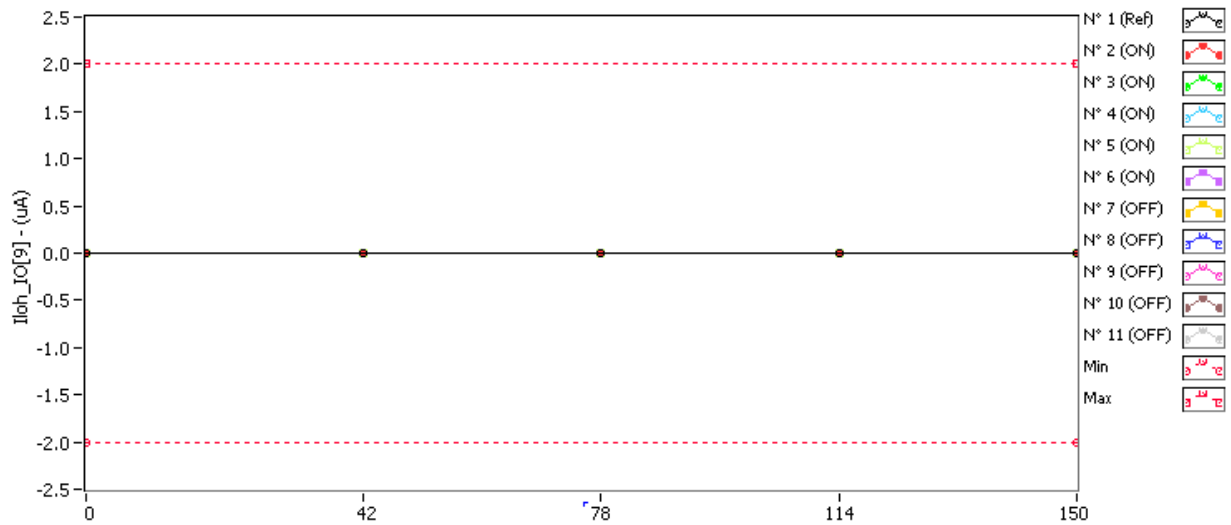

Iloh_IO[9] . (uA) Min = -2.0 Max = 2.0

	0krad(Si)	42krad(Si)	78krad(Si)	114krad(Si)	150krad(Si)
N° 1 (Ref)	1.314E-3	2.306E-3	2.688E-3	2.459E-3	3.145E-3
N° 2 (ON)	1.848E-3	2.306E-3	1.848E-3	3.374E-3	3.145E-3
N° 3 (ON)	2.382E-3	3.222E-3	1.925E-3	2.840E-3	2.688E-3
N° 4 (ON)	1.467E-3	1.925E-3	3.069E-3	2.993E-3	1.314E-3
N° 5 (ON)	2.001E-3	1.772E-3	3.451E-3	2.001E-3	2.993E-3
N° 6 (ON)	1.620E-3	1.085E-3	2.382E-3	2.688E-3	2.764E-3
N° 7 (OFF)	2.840E-3	2.230E-3	2.611E-3	2.993E-3	3.451E-3
N° 8 (OFF)	3.679E-3	1.772E-3	2.993E-3	1.467E-3	2.382E-3
N° 9 (OFF)	1.848E-3	2.230E-3	1.314E-3	1.696E-3	2.764E-3
N° 10 (OFF)	1.925E-3	2.993E-3	3.451E-3	3.222E-3	1.772E-3
N° 11 (OFF)	3.069E-3	3.145E-3	3.451E-3	2.154E-3	2.611E-3

Delta [Iloh_IO[9]]

	0krad(Si)	42krad(Si)	78krad(Si)	114krad(Si)	150krad(Si)
N° 1 (Ref)	---	9.919E-4	1.373E-3	1.144E-3	1.831E-3
N° 2 (ON)	---	4.578E-4	0.000E+0	1.526E-3	1.297E-3
N° 3 (ON)	---	8.393E-4	-4.577E-4	4.578E-4	3.052E-4
N° 4 (ON)	---	4.578E-4	1.602E-3	1.526E-3	-1.526E-4
N° 5 (ON)	---	-2.289E-4	1.450E-3	0.000E+0	9.918E-4
N° 6 (ON)	---	-5.341E-4	7.629E-4	1.068E-3	1.144E-3
N° 7 (OFF)	---	-6.103E-4	-2.289E-4	1.526E-4	6.104E-4
N° 8 (OFF)	---	-1.907E-3	-6.866E-4	-2.213E-3	-1.297E-3
N° 9 (OFF)	---	3.815E-4	-5.341E-4	-1.526E-4	9.155E-4
N° 10 (OFF)	---	1.068E-3	1.526E-3	1.297E-3	-1.526E-4
N° 11 (OFF)	---	7.630E-5	3.815E-4	-9.155E-4	-4.578E-4
Average (ON)	---	1.984E-4	6.714E-4	9.155E-4	7.172E-4
s (ON)	---	5.622E-4	8.953E-4	6.738E-4	6.165E-4
Average+3s (ON)	---	1.885E-3	3.357E-3	2.937E-3	2.567E-3
Average-3s (ON)	---	-1.488E-3	-2.014E-3	-1.106E-3	-1.132E-3
Average (OFF)	---	-1.983E-4	9.156E-5	-3.662E-4	-7.630E-5
s (OFF)	---	1.130E-3	9.001E-4	1.303E-3	8.799E-4
Average+3s (OFF)	---	3.191E-3	2.792E-3	3.543E-3	2.563E-3
Average-3s (OFF)	---	-3.588E-3	-2.609E-3	-4.275E-3	-2.716E-3

57. Iloh_IO[10]

Ta = 25°C, Vcc = 3.3V, Vout = Vcc

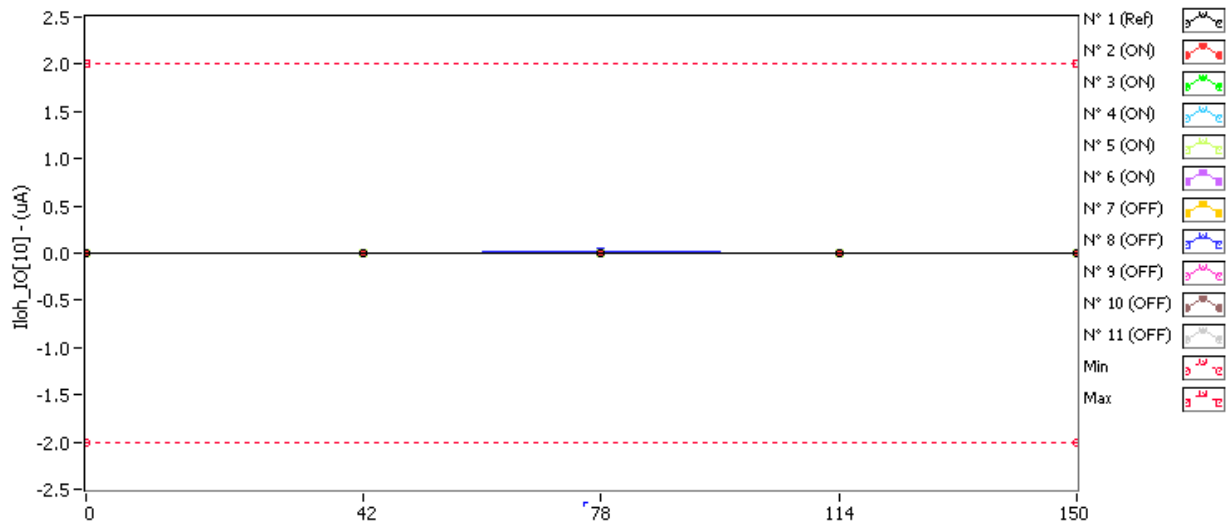

Iloh_IO[10] . (uA) Min = -2.0 Max = 2.0

	0krad(Si)	42krad(Si)	78krad(Si)	114krad(Si)	150krad(Si)
N° 1 (Ref)	2.154E-3	2.459E-3	3.298E-3	3.756E-3	3.679E-3
N° 2 (ON)	1.848E-3	3.908E-3	2.764E-3	4.366E-3	3.069E-3
N° 3 (ON)	2.230E-3	1.391E-3	1.772E-3	2.535E-3	2.764E-3
N° 4 (ON)	2.382E-3	2.764E-3	2.001E-3	2.306E-3	1.848E-3
N° 5 (ON)	1.467E-3	1.314E-3	2.993E-3	3.603E-3	1.848E-3
N° 6 (ON)	1.085E-3	1.009E-3	3.603E-3	2.230E-3	2.840E-3
N° 7 (OFF)	2.001E-3	2.840E-3	2.001E-3	4.290E-3	1.543E-3
N° 8 (OFF)	2.611E-3	9.363E-5	9.707E-3	3.832E-3	1.543E-3
N° 9 (OFF)	1.467E-3	1.620E-3	3.222E-3	3.451E-3	2.382E-3
N° 10 (OFF)	2.688E-3	2.306E-3	3.069E-3	3.374E-3	3.374E-3
N° 11 (OFF)	1.391E-3	2.916E-3	3.145E-3	4.061E-3	2.916E-3

Delta [Iloh_IO[10]]

	0krad(Si)	42krad(Si)	78krad(Si)	114krad(Si)	150krad(Si)
N° 1 (Ref)	---	3.051E-4	1.144E-3	1.602E-3	1.526E-3
N° 2 (ON)	---	2.060E-3	9.155E-4	2.518E-3	1.221E-3
N° 3 (ON)	---	-8.393E-4	-4.578E-4	3.051E-4	5.340E-4
N° 4 (ON)	---	3.815E-4	-3.814E-4	-7.620E-5	-5.340E-4
N° 5 (ON)	---	-1.526E-4	1.526E-3	2.136E-3	3.815E-4
N° 6 (ON)	---	-7.620E-5	2.518E-3	1.144E-3	1.755E-3
N° 7 (OFF)	---	8.392E-4	0.000E+0	2.289E-3	-4.578E-4
N° 8 (OFF)	---	-2.518E-3	7.095E-3	1.221E-3	-1.068E-3
N° 9 (OFF)	---	1.526E-4	1.755E-3	1.984E-3	9.155E-4
N° 10 (OFF)	---	-3.814E-4	3.815E-4	6.867E-4	6.867E-4
N° 11 (OFF)	---	1.526E-3	1.755E-3	2.670E-3	1.526E-3
Average (ON)	---	2.747E-4	8.240E-4	1.205E-3	6.714E-4
s (ON)	---	1.089E-3	1.271E-3	1.123E-3	8.705E-4
Average+3s (ON)	---	3.542E-3	4.638E-3	4.575E-3	3.283E-3
Average-3s (ON)	---	-2.993E-3	-2.990E-3	-2.164E-3	-1.940E-3
Average (OFF)	---	-7.627E-5	2.197E-3	1.770E-3	3.204E-4
s (OFF)	---	1.542E-3	2.851E-3	8.063E-4	1.058E-3
Average+3s (OFF)	---	4.550E-3	1.075E-2	4.189E-3	3.494E-3
Average-3s (OFF)	---	-4.702E-3	-6.355E-3	-6.489E-4	-2.853E-3

58. Iloh_IO[11]

Ta = 25°C, Vcc = 3.3V, Vout = Vcc

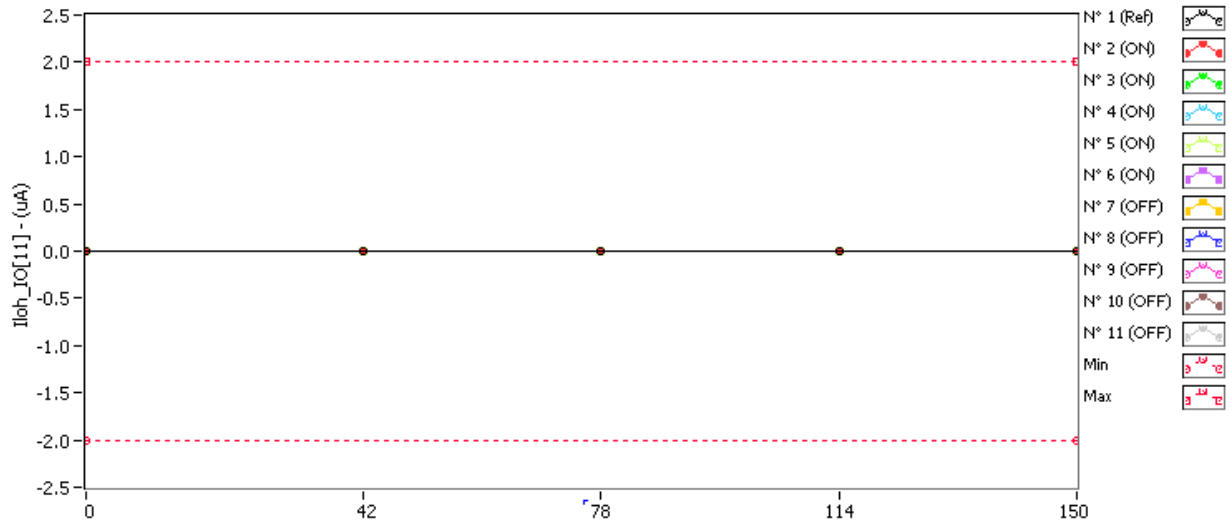

Iloh_IO[11] . (uA) Min = -2.0 Max = 2.0

	0krad(Si)	42krad(Si)	78krad(Si)	114krad(Si)	150krad(Si)
N° 1 (Ref)	2.382E-3	8.566E-4	8.566E-4	1.848E-3	2.077E-3
N° 2 (ON)	1.314E-3	1.543E-3	2.462E-4	1.314E-3	4.751E-4
N° 3 (ON)	2.001E-3	1.543E-3	1.925E-3	2.001E-3	2.535E-3
N° 4 (ON)	1.772E-3	8.566E-4	9.329E-4	2.688E-3	1.162E-3
N° 5 (ON)	9.329E-4	3.988E-4	1.772E-3	7.040E-4	2.306E-3
N° 6 (ON)	8.566E-4	1.391E-3	1.085E-3	2.077E-3	3.988E-4
N° 7 (OFF)	1.162E-3	7.803E-4	1.238E-3	2.306E-3	1.696E-3
N° 8 (OFF)	2.077E-3	1.772E-3	1.314E-3	1.925E-3	2.230E-3
N° 9 (OFF)	3.988E-4	2.462E-4	2.001E-3	8.566E-4	1.391E-3
N° 10 (OFF)	1.238E-3	2.001E-3	1.162E-3	2.306E-3	2.611E-3
N° 11 (OFF)	2.001E-3	2.154E-3	7.040E-4	2.459E-3	1.925E-3

Delta [Iloh_IO[11]]

	0krad(Si)	42krad(Si)	78krad(Si)	114krad(Si)	150krad(Si)
N° 1 (Ref)	---	-1.526E-3	-1.526E-3	-5.340E-4	-3.051E-4
N° 2 (ON)	---	2.289E-4	-1.068E-3	0.000E+0	-8.392E-4
N° 3 (ON)	---	-4.578E-4	-7.630E-5	0.000E+0	5.340E-4
N° 4 (ON)	---	-9.155E-4	-8.392E-4	9.155E-4	-6.104E-4
N° 5 (ON)	---	-5.341E-4	8.392E-4	-2.289E-4	1.373E-3
N° 6 (ON)	---	5.340E-4	2.288E-4	1.221E-3	-4.578E-4
N° 7 (OFF)	---	-3.814E-4	7.630E-5	1.144E-3	5.341E-4
N° 8 (OFF)	---	-3.052E-4	-7.630E-4	-1.526E-4	1.526E-4
N° 9 (OFF)	---	-1.526E-4	1.602E-3	4.578E-4	9.918E-4
N° 10 (OFF)	---	7.630E-4	-7.630E-5	1.068E-3	1.373E-3
N° 11 (OFF)	---	1.526E-4	-1.297E-3	4.577E-4	-7.630E-5
Average (ON)	---	-2.289E-4	-1.831E-4	3.815E-4	-6.000E-9
s (ON)	---	5.934E-4	7.810E-4	6.429E-4	9.297E-4
Average+3s (ON)	---	1.551E-3	2.160E-3	2.310E-3	2.789E-3
Average-3s (ON)	---	-2.009E-3	-2.526E-3	-1.547E-3	-2.789E-3
Average (OFF)	---	1.528E-5	-9.156E-5	5.951E-4	5.951E-4
s (OFF)	---	4.654E-4	1.096E-3	5.297E-4	5.944E-4
Average+3s (OFF)	---	1.411E-3	3.195E-3	2.184E-3	2.378E-3
Average-3s (OFF)	---	-1.381E-3	-3.378E-3	-9.941E-4	-1.188E-3

59. Iloh_IO[12]

Ta = 25°C, Vcc = 3.3V, Vout = Vcc

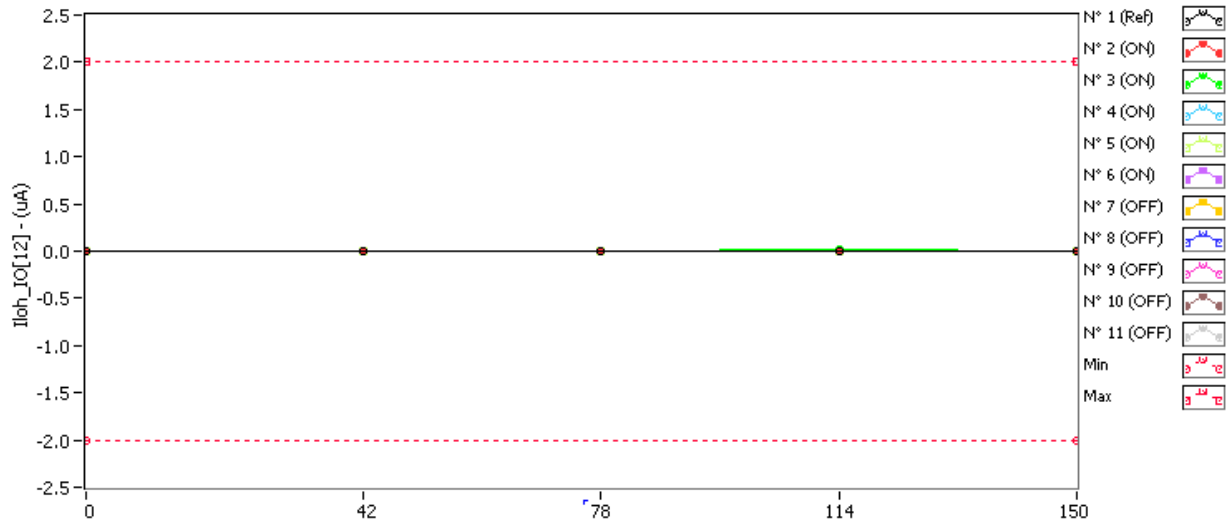

Iloh_IO[12] . (uA) Min = -2.0 Max = 2.0

	0krad(Si)	42krad(Si)	78krad(Si)	114krad(Si)	150krad(Si)
N° 1 (Ref)	2.993E-3	2.688E-3	3.374E-3	2.535E-3	3.298E-3
N° 2 (ON)	1.848E-3	2.230E-3	1.620E-3	2.154E-3	3.069E-3
N° 3 (ON)	2.916E-3	2.535E-3	2.764E-3	9.325E-3	8.639E-3
N° 4 (ON)	3.374E-3	3.145E-3	2.077E-3	4.061E-3	3.908E-3
N° 5 (ON)	1.162E-3	2.611E-3	3.527E-3	1.925E-3	3.908E-3
N° 6 (ON)	2.382E-3	3.603E-3	2.306E-3	3.374E-3	3.298E-3
N° 7 (OFF)	2.535E-3	2.306E-3	3.374E-3	2.611E-3	3.603E-3
N° 8 (OFF)	3.069E-3	3.451E-3	2.764E-3	1.620E-3	3.374E-3
N° 9 (OFF)	1.314E-3	2.611E-3	1.543E-3	2.459E-3	3.298E-3
N° 10 (OFF)	3.145E-3	1.925E-3	1.772E-3	2.916E-3	2.306E-3
N° 11 (OFF)	3.679E-3	2.459E-3	2.001E-3	2.840E-3	3.679E-3

Delta [Iloh_IO[12]]

	0krad(Si)	42krad(Si)	78krad(Si)	114krad(Si)	150krad(Si)
N° 1 (Ref)	---	-3.052E-4	3.815E-4	-4.578E-4	3.052E-4
N° 2 (ON)	---	3.815E-4	-2.289E-4	3.052E-4	1.221E-3
N° 3 (ON)	---	-3.815E-4	-1.526E-4	6.409E-3	5.722E-3
N° 4 (ON)	---	-2.289E-4	-1.297E-3	6.866E-4	5.340E-4
N° 5 (ON)	---	1.450E-3	2.365E-3	7.630E-4	2.747E-3
N° 6 (ON)	---	1.221E-3	-7.620E-5	9.919E-4	9.156E-4
N° 7 (OFF)	---	-2.288E-4	8.393E-4	7.630E-5	1.068E-3
N° 8 (OFF)	---	3.815E-4	-3.052E-4	-1.450E-3	3.052E-4
N° 9 (OFF)	---	1.297E-3	2.289E-4	1.144E-3	1.984E-3
N° 10 (OFF)	---	-1.221E-3	-1.373E-3	-2.289E-4	-8.392E-4
N° 11 (OFF)	---	-1.221E-3	-1.678E-3	-8.392E-4	0.000E+0
Average (ON)	---	4.883E-4	1.221E-4	1.831E-3	2.228E-3
s (ON)	---	8.281E-4	1.349E-3	2.571E-3	2.126E-3
Average+3s (ON)	---	2.973E-3	4.170E-3	9.544E-3	8.607E-3
Average-3s (ON)	---	-1.996E-3	-3.926E-3	-5.882E-3	-4.151E-3
Average (OFF)	---	-1.983E-4	-4.577E-4	-2.594E-4	5.036E-4
s (OFF)	---	1.080E-3	1.061E-3	9.794E-4	1.073E-3
Average+3s (OFF)	---	3.041E-3	2.726E-3	2.679E-3	3.723E-3
Average-3s (OFF)	---	-3.438E-3	-3.642E-3	-3.198E-3	-2.715E-3

60. Iloh_IO[13]

Ta = 25°C, Vcc = 3.3V, Vout = Vcc

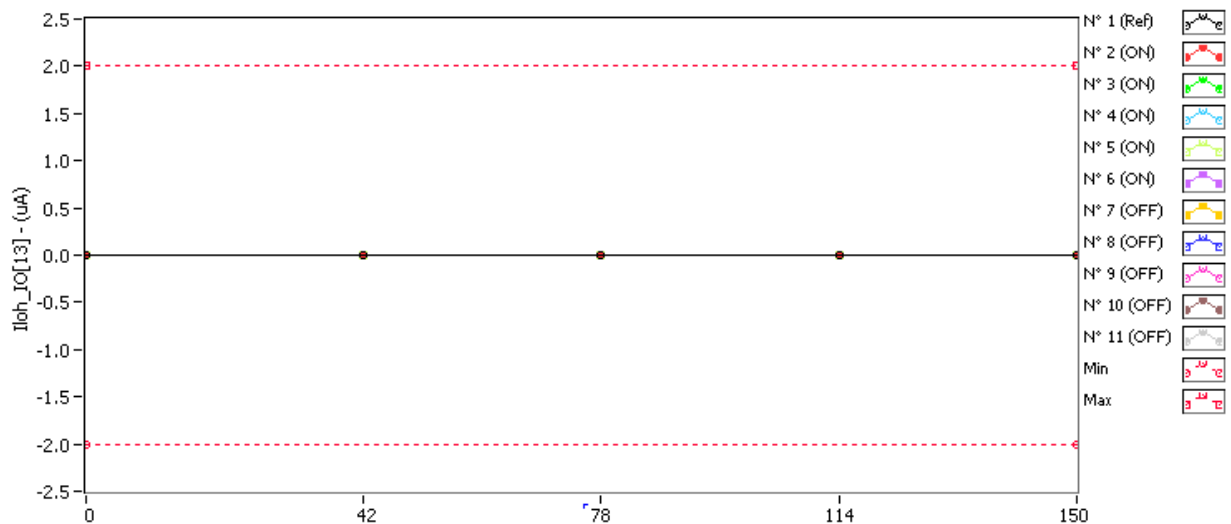

Iloh_IO[13] . (uA) Min = -2.0 Max = 2.0

	0krad(Si)	42krad(Si)	78krad(Si)	114krad(Si)	150krad(Si)
N° 1 (Ref)	1.925E-3	5.514E-4	8.566E-4	2.611E-3	2.459E-3
N° 2 (ON)	2.459E-3	1.620E-3	6.277E-4	2.993E-3	2.993E-3
N° 3 (ON)	6.277E-4	6.277E-4	1.543E-3	2.306E-3	1.467E-3
N° 4 (ON)	2.611E-3	2.001E-3	3.988E-4	2.688E-3	2.306E-3
N° 5 (ON)	1.925E-3	2.459E-3	1.162E-3	2.001E-3	2.306E-3
N° 6 (ON)	2.382E-3	7.803E-4	1.162E-3	3.985E-3	2.306E-3
N° 7 (OFF)	2.462E-4	2.001E-3	2.001E-3	1.543E-3	1.467E-3
N° 8 (OFF)	1.772E-3	2.077E-3	1.009E-3	2.230E-3	9.329E-4
N° 9 (OFF)	3.225E-4	2.230E-3	2.382E-3	3.679E-3	2.154E-3
N° 10 (OFF)	9.329E-4	1.925E-3	3.225E-4	2.840E-3	2.916E-3
N° 11 (OFF)	2.382E-3	4.751E-4	2.993E-3	3.374E-3	2.840E-3

Delta [Iloh_IO[13]]

	0krad(Si)	42krad(Si)	78krad(Si)	114krad(Si)	150krad(Si)
N° 1 (Ref)	---	-1.373E-3	-1.068E-3	6.866E-4	5.340E-4
N° 2 (ON)	---	-8.392E-4	-1.831E-3	5.341E-4	5.341E-4
N° 3 (ON)	---	0.000E+0	9.155E-4	1.679E-3	8.392E-4
N° 4 (ON)	---	-6.103E-4	-2.213E-3	7.630E-5	-3.051E-4
N° 5 (ON)	---	5.340E-4	-7.630E-4	7.630E-5	3.815E-4
N° 6 (ON)	---	-1.602E-3	-1.221E-3	1.602E-3	-7.620E-5
N° 7 (OFF)	---	1.755E-3	1.755E-3	1.297E-3	1.221E-3
N° 8 (OFF)	---	3.052E-4	-7.629E-4	4.578E-4	-8.392E-4
N° 9 (OFF)	---	1.907E-3	2.060E-3	3.357E-3	1.831E-3
N° 10 (OFF)	---	9.918E-4	-6.103E-4	1.907E-3	1.984E-3
N° 11 (OFF)	---	-1.907E-3	6.104E-4	9.919E-4	4.578E-4
Average (ON)	---	-5.035E-4	-1.022E-3	7.935E-4	2.747E-4
s (ON)	---	8.156E-4	1.218E-3	7.958E-4	4.628E-4
Average+3s (ON)	---	1.943E-3	2.631E-3	3.181E-3	1.663E-3
Average-3s (ON)	---	-2.950E-3	-4.676E-3	-1.594E-3	-1.114E-3
Average (OFF)	---	6.104E-4	6.104E-4	1.602E-3	9.308E-4
s (OFF)	---	1.547E-3	1.303E-3	1.112E-3	1.158E-3
Average+3s (OFF)	---	5.251E-3	4.518E-3	4.939E-3	4.403E-3
Average-3s (OFF)	---	-4.030E-3	-3.297E-3	-1.734E-3	-2.542E-3

61. Iloh_IO[14]

Ta = 25°C, Vcc = 3.3V, Vout = Vcc

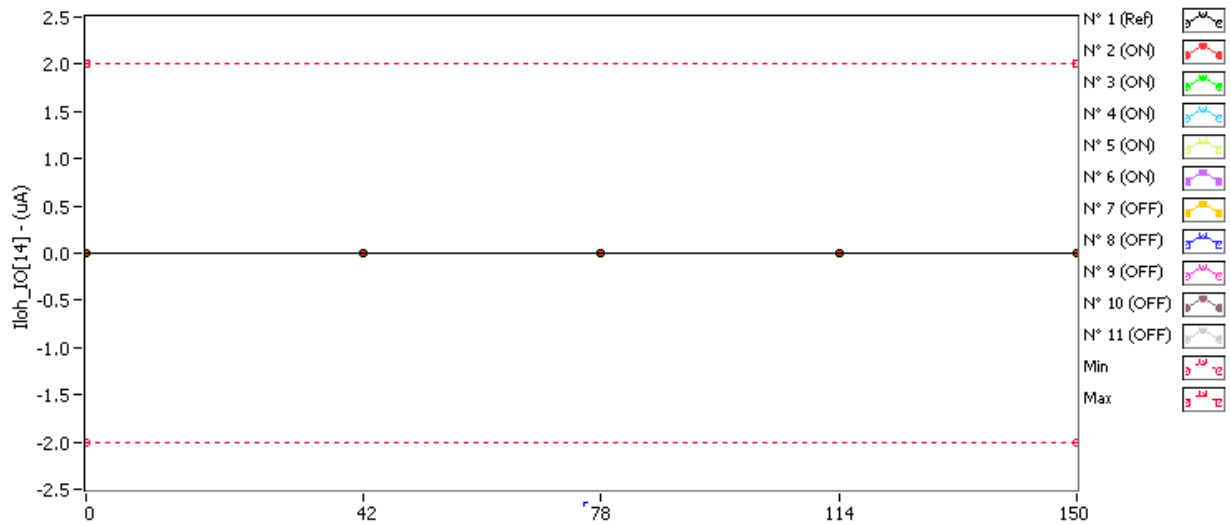

Iloh_IO[14] . (uA) Min = -2.0 Max = 2.0

	0krad(Si)	42krad(Si)	78krad(Si)	114krad(Si)	150krad(Si)
N° 1 (Ref)	1.085E-3	3.988E-4	1.772E-3	3.069E-3	1.848E-3
N° 2 (ON)	1.543E-3	2.382E-3	2.077E-3	3.756E-3	2.459E-3
N° 3 (ON)	2.230E-3	1.772E-3	2.382E-3	2.077E-3	2.382E-3
N° 4 (ON)	1.238E-3	2.306E-3	2.462E-4	3.222E-3	2.764E-3
N° 5 (ON)	9.329E-4	8.566E-4	1.699E-4	2.382E-3	2.611E-3
N° 6 (ON)	2.230E-3	2.230E-3	1.391E-3	6.045E-3	4.290E-3
N° 7 (OFF)	1.467E-3	1.314E-3	2.764E-3	2.611E-3	1.238E-3
N° 8 (OFF)	1.085E-3	2.611E-3	5.514E-4	2.764E-3	9.329E-4
N° 9 (OFF)	2.001E-3	1.467E-3	1.467E-3	2.916E-3	1.085E-3
N° 10 (OFF)	1.772E-3	1.391E-3	2.916E-3	3.527E-3	3.985E-3
N° 11 (OFF)	4.751E-4	7.803E-4	2.611E-3	2.993E-3	3.145E-3

Delta [Iloh_IO[14]]

	0krad(Si)	42krad(Si)	78krad(Si)	114krad(Si)	150krad(Si)
N° 1 (Ref)	---	-6.866E-4	6.867E-4	1.984E-3	7.630E-4
N° 2 (ON)	---	8.392E-4	5.341E-4	2.213E-3	9.155E-4
N° 3 (ON)	---	-4.578E-4	1.525E-4	-1.526E-4	1.525E-4
N° 4 (ON)	---	1.068E-3	-9.918E-4	1.984E-3	1.526E-3
N° 5 (ON)	---	-7.629E-5	-7.629E-4	1.450E-3	1.678E-3
N° 6 (ON)	---	0.000E+0	-8.393E-4	3.815E-3	2.060E-3
N° 7 (OFF)	---	-1.526E-4	1.297E-3	1.144E-3	-2.289E-4
N° 8 (OFF)	---	1.526E-3	-5.340E-4	1.679E-3	-1.525E-4
N° 9 (OFF)	---	-5.341E-4	-5.341E-4	9.155E-4	-9.156E-4
N° 10 (OFF)	---	-3.815E-4	1.144E-3	1.755E-3	2.212E-3
N° 11 (OFF)	---	3.052E-4	2.136E-3	2.518E-3	2.670E-3
Average (ON)	---	2.747E-4	-3.815E-4	1.862E-3	1.266E-3
s (ON)	---	6.488E-4	6.803E-4	1.430E-3	7.468E-4
Average+3s (ON)	---	2.221E-3	1.659E-3	6.152E-3	3.507E-3
Average-3s (ON)	---	-1.672E-3	-2.422E-3	-2.428E-3	-9.739E-4
Average (OFF)	---	1.526E-4	7.019E-4	1.602E-3	7.172E-4
s (OFF)	---	8.305E-4	1.190E-3	6.222E-4	1.610E-3
Average+3s (OFF)	---	2.644E-3	4.271E-3	3.469E-3	5.547E-3
Average-3s (OFF)	---	-2.339E-3	-2.867E-3	-2.643E-4	-4.113E-3

62. Iloh_IO[15]

Ta = 25°C, Vcc = 3.3V, Vout = Vcc

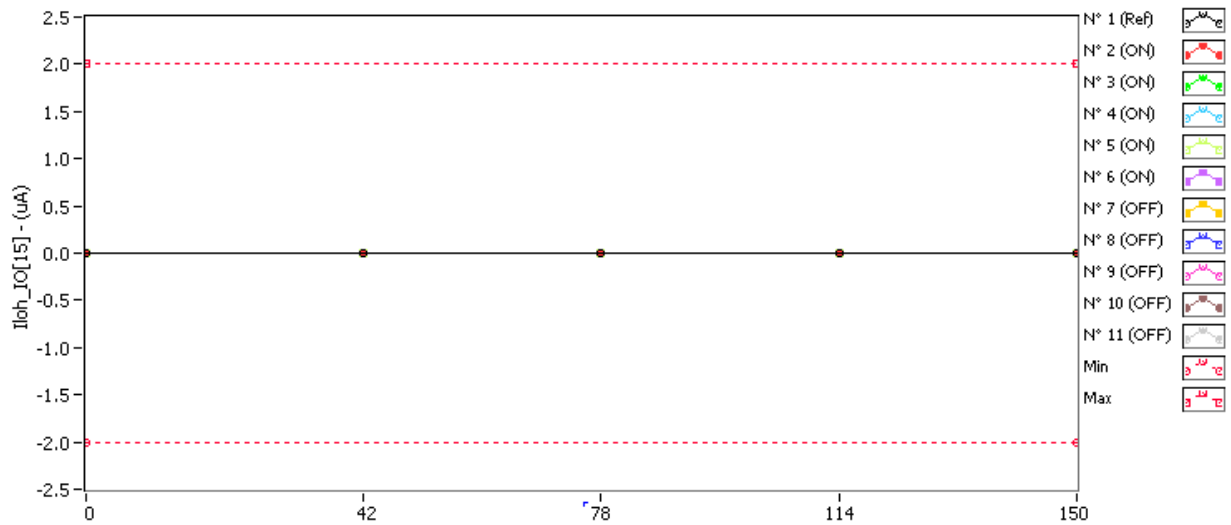

Iloh_IO[15] . (uA) Min = -2.0 Max = 2.0

	0krad(Si)	42krad(Si)	78krad(Si)	114krad(Si)	150krad(Si)
N° 1 (Ref)	2.154E-3	1.314E-3	2.230E-3	2.916E-3	3.374E-3
N° 2 (ON)	2.764E-3	1.467E-3	3.527E-3	2.688E-3	2.459E-3
N° 3 (ON)	2.306E-3	2.611E-3	3.374E-3	2.993E-3	3.451E-3
N° 4 (ON)	3.145E-3	1.620E-3	3.222E-3	1.848E-3	3.679E-3
N° 5 (ON)	3.069E-3	2.001E-3	3.069E-3	3.374E-3	2.077E-3
N° 6 (ON)	2.764E-3	2.154E-3	2.001E-3	3.832E-3	2.611E-3
N° 7 (OFF)	1.391E-3	3.145E-3	2.688E-3	1.696E-3	2.688E-3
N° 8 (OFF)	2.077E-3	2.459E-3	1.238E-3	1.848E-3	6.045E-3
N° 9 (OFF)	3.298E-3	2.535E-3	1.696E-3	2.688E-3	3.374E-3
N° 10 (OFF)	3.451E-3	2.535E-3	2.688E-3	3.832E-3	2.001E-3
N° 11 (OFF)	1.238E-3	3.145E-3	1.620E-3	2.688E-3	3.603E-3

Delta [Iloh_IO[15]]

	0krad(Si)	42krad(Si)	78krad(Si)	114krad(Si)	150krad(Si)
N° 1 (Ref)	---	-8.393E-4	7.630E-5	7.629E-4	1.221E-3
N° 2 (ON)	---	-1.297E-3	7.630E-4	-7.630E-5	-3.052E-4
N° 3 (ON)	---	3.051E-4	1.068E-3	6.866E-4	1.144E-3
N° 4 (ON)	---	-1.526E-3	7.630E-5	-1.297E-3	5.340E-4
N° 5 (ON)	---	-1.068E-3	0.000E+0	3.052E-4	-9.918E-4
N° 6 (ON)	---	-6.103E-4	-7.629E-4	1.068E-3	-1.526E-4
N° 7 (OFF)	---	1.755E-3	1.297E-3	3.052E-4	1.297E-3
N° 8 (OFF)	---	3.814E-4	-8.393E-4	-2.289E-4	3.967E-3
N° 9 (OFF)	---	-7.630E-4	-1.602E-3	-6.104E-4	7.630E-5
N° 10 (OFF)	---	-9.156E-4	-7.630E-4	3.814E-4	-1.450E-3
N° 11 (OFF)	---	1.907E-3	3.815E-4	1.450E-3	2.365E-3
Average (ON)	---	-8.392E-4	2.289E-4	1.373E-4	4.576E-5
s (ON)	---	7.238E-4	7.157E-4	9.082E-4	8.192E-4
Average+3s (ON)	---	1.332E-3	2.376E-3	2.862E-3	2.503E-3
Average-3s (ON)	---	-3.011E-3	-1.918E-3	-2.587E-3	-2.412E-3
Average (OFF)	---	4.730E-4	-3.052E-4	2.594E-4	1.251E-3
s (OFF)	---	1.338E-3	1.142E-3	7.792E-4	2.079E-3
Average+3s (OFF)	---	4.488E-3	3.120E-3	2.597E-3	7.489E-3
Average-3s (OFF)	---	-3.542E-3	-3.731E-3	-2.078E-3	-4.987E-3

63. IIOI_IO[0]

Ta = 25°C, Vcc = 3.3V, Vout = 0V

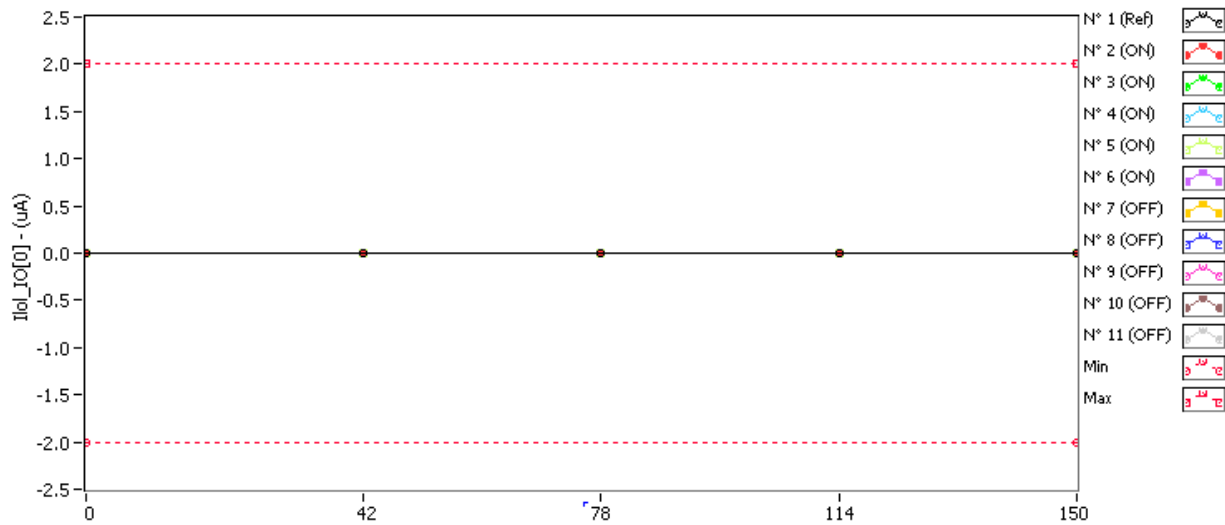

IIOI_IO[0] . (uA) Min = -2.0 Max = 2.0

	0krad(Si)	42krad(Si)	78krad(Si)	114krad(Si)	150krad(Si)
N° 1 (Ref)	2.688E-3	1.620E-3	2.077E-3	2.916E-3	1.467E-3
N° 2 (ON)	1.848E-3	3.145E-3	1.848E-3	2.382E-3	2.077E-3
N° 3 (ON)	1.314E-3	2.154E-3	1.391E-3	2.764E-3	7.803E-4
N° 4 (ON)	3.222E-3	2.306E-3	1.772E-3	1.696E-3	2.230E-3
N° 5 (ON)	2.382E-3	3.222E-3	2.306E-3	1.925E-3	2.001E-3
N° 6 (ON)	2.764E-3	2.840E-3	1.620E-3	3.069E-3	1.009E-3
N° 7 (OFF)	3.222E-3	2.764E-3	2.535E-3	2.688E-3	6.277E-4
N° 8 (OFF)	3.222E-3	1.620E-3	2.535E-3	1.085E-3	2.916E-3
N° 9 (OFF)	9.329E-4	1.009E-3	1.162E-3	1.696E-3	1.391E-3
N° 10 (OFF)	2.535E-3	2.916E-3	1.543E-3	2.916E-3	1.848E-3
N° 11 (OFF)	2.077E-3	1.391E-3	1.543E-3	1.467E-3	2.764E-3

Delta [IIOI_IO[0]]

	0krad(Si)	42krad(Si)	78krad(Si)	114krad(Si)	150krad(Si)
N° 1 (Ref)	---	-1.068E-3	-6.103E-4	2.289E-4	-1.221E-3
N° 2 (ON)	---	1.297E-3	0.000E+0	5.340E-4	2.289E-4
N° 3 (ON)	---	8.393E-4	7.630E-5	1.450E-3	-5.340E-4
N° 4 (ON)	---	-9.155E-4	-1.450E-3	-1.526E-3	-9.918E-4
N° 5 (ON)	---	8.393E-4	-7.620E-5	-4.577E-4	-3.814E-4
N° 6 (ON)	---	7.630E-5	-1.144E-3	3.052E-4	-1.755E-3
N° 7 (OFF)	---	-4.578E-4	-6.867E-4	-5.341E-4	-2.594E-3
N° 8 (OFF)	---	-1.602E-3	-6.867E-4	-2.136E-3	-3.052E-4
N° 9 (OFF)	---	7.634E-5	2.288E-4	7.629E-4	4.577E-4
N° 10 (OFF)	---	3.815E-4	-9.918E-4	3.815E-4	-6.866E-4
N° 11 (OFF)	---	-6.867E-4	-5.341E-4	-6.104E-4	6.866E-4
Average (ON)	---	4.273E-4	-5.188E-4	6.104E-5	-6.866E-4
s (ON)	---	8.692E-4	7.206E-4	1.118E-3	7.397E-4
Average+3s (ON)	---	3.035E-3	1.643E-3	3.415E-3	1.532E-3
Average-3s (ON)	---	-2.180E-3	-2.681E-3	-3.293E-3	-2.906E-3
Average (OFF)	---	-4.578E-4	-5.341E-4	-4.273E-4	-4.883E-4
s (OFF)	---	7.668E-4	4.578E-4	1.122E-3	1.302E-3
Average+3s (OFF)	---	1.843E-3	8.392E-4	2.939E-3	3.418E-3
Average-3s (OFF)	---	-2.758E-3	-1.907E-3	-3.794E-3	-4.395E-3

64. IloI_IO[1]

Ta = 25°C, Vcc = 3.3V, Vout = 0V

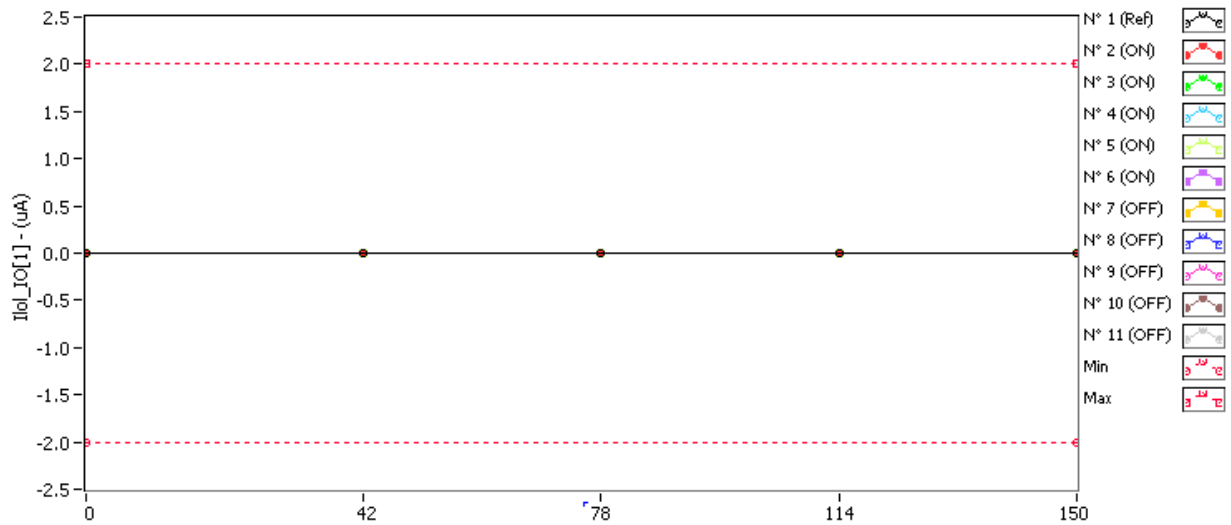

IloI_IO[1] . (uA) Min = -2.0 Max = 2.0

	0krad(Si)	42krad(Si)	78krad(Si)	114krad(Si)	150krad(Si)
N° 1 (Ref)	6.277E-4	2.688E-3	1.009E-3	7.803E-4	1.314E-3
N° 2 (ON)	1.009E-3	1.238E-3	8.566E-4	3.988E-4	1.699E-4
N° 3 (ON)	1.733E-5	2.306E-3	1.772E-3	6.277E-4	2.306E-3
N° 4 (ON)	9.363E-5	1.009E-3	5.514E-4	2.611E-3	2.001E-3
N° 5 (ON)	5.514E-4	6.277E-4	1.009E-3	1.238E-3	2.001E-3
N° 6 (ON)	1.772E-3	1.848E-3	1.391E-3	6.277E-4	7.803E-4
N° 7 (OFF)	1.543E-3	2.306E-3	1.391E-3	4.751E-4	1.467E-3
N° 8 (OFF)	1.314E-3	1.620E-3	2.382E-3	1.925E-3	2.306E-3
N° 9 (OFF)	1.848E-3	1.314E-3	4.751E-4	2.306E-3	2.077E-3
N° 10 (OFF)	2.001E-3	1.925E-3	1.772E-3	1.733E-5	4.751E-4
N° 11 (OFF)	1.162E-3	2.077E-3	1.620E-3	1.238E-3	6.277E-4

Delta [IloI_IO[1]]

	0krad(Si)	42krad(Si)	78krad(Si)	114krad(Si)	150krad(Si)
N° 1 (Ref)	---	2.060E-3	3.815E-4	1.526E-4	6.866E-4
N° 2 (ON)	---	2.288E-4	-1.526E-4	-6.104E-4	-8.393E-4
N° 3 (ON)	---	2.289E-3	1.755E-3	6.104E-4	2.289E-3
N° 4 (ON)	---	9.156E-4	4.578E-4	2.518E-3	1.907E-3
N° 5 (ON)	---	7.630E-5	4.578E-4	6.866E-4	1.450E-3
N° 6 (ON)	---	7.630E-5	-3.815E-4	-1.144E-3	-9.918E-4
N° 7 (OFF)	---	7.630E-4	-1.526E-4	-1.068E-3	-7.630E-5
N° 8 (OFF)	---	3.052E-4	1.068E-3	6.104E-4	9.919E-4
N° 9 (OFF)	---	-5.341E-4	-1.373E-3	4.578E-4	2.289E-4
N° 10 (OFF)	---	-7.630E-5	-2.289E-4	-1.984E-3	-1.526E-3
N° 11 (OFF)	---	9.156E-4	4.578E-4	7.630E-5	-5.340E-4
Average (ON)	---	7.172E-4	4.272E-4	4.120E-4	7.629E-4
s (ON)	---	9.447E-4	8.298E-4	1.416E-3	1.562E-3
Average+3s (ON)	---	3.551E-3	2.917E-3	4.659E-3	5.448E-3
Average-3s (ON)	---	-2.117E-3	-2.062E-3	-3.835E-3	-3.922E-3
Average (OFF)	---	2.747E-4	-4.578E-5	-3.815E-4	-1.831E-4
s (OFF)	---	5.974E-4	9.085E-4	1.111E-3	9.338E-4
Average+3s (OFF)	---	2.067E-3	2.680E-3	2.951E-3	2.618E-3
Average-3s (OFF)	---	-1.517E-3	-2.771E-3	-3.714E-3	-2.985E-3

65. IIOI_IO[2]

Ta = 25°C, Vcc = 3.3V, Vout = 0V

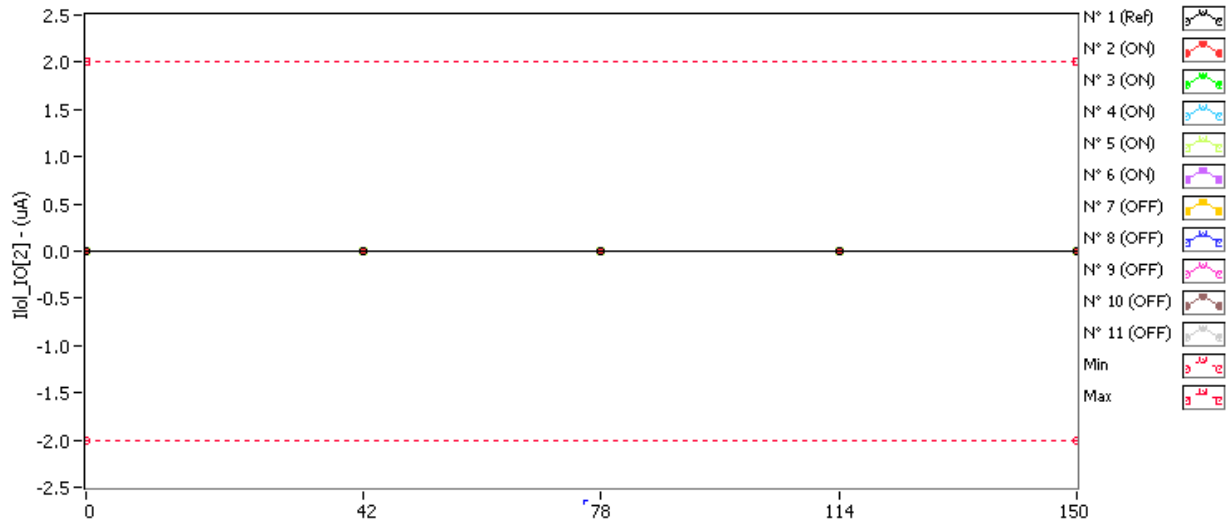

IIOI_IO[2] . (uA) Min = -2.0 Max = 2.0

	0krad(Si)	42krad(Si)	78krad(Si)	114krad(Si)	150krad(Si)
N° 1 (Ref)	2.382E-3	4.751E-4	7.040E-4	8.566E-4	1.162E-3
N° 2 (ON)	2.462E-4	1.699E-4	1.696E-3	2.611E-3	2.535E-3
N° 3 (ON)	2.001E-3	5.514E-4	1.009E-3	1.009E-3	9.329E-4
N° 4 (ON)	4.751E-4	2.382E-3	2.535E-3	9.329E-4	2.077E-3
N° 5 (ON)	8.566E-4	2.306E-3	1.848E-3	2.306E-3	9.363E-5
N° 6 (ON)	2.611E-3	4.751E-4	9.329E-4	7.040E-4	1.467E-3
N° 7 (OFF)	3.988E-4	2.306E-3	2.077E-3	9.329E-4	1.848E-3
N° 8 (OFF)	1.620E-3	2.764E-3	2.459E-3	2.916E-3	8.566E-4
N° 9 (OFF)	8.566E-4	6.277E-4	7.040E-4	2.306E-3	2.462E-4
N° 10 (OFF)	1.238E-3	3.988E-4	6.277E-4	1.009E-3	1.696E-3
N° 11 (OFF)	2.154E-3	2.459E-3	2.611E-3	1.772E-3	2.230E-3

Delta [IIOI_IO[2]]

	0krad(Si)	42krad(Si)	78krad(Si)	114krad(Si)	150krad(Si)
N° 1 (Ref)	---	-1.907E-3	-1.678E-3	-1.526E-3	-1.221E-3
N° 2 (ON)	---	-7.630E-5	1.450E-3	2.365E-3	2.289E-3
N° 3 (ON)	---	-1.450E-3	-9.918E-4	-9.918E-4	-1.068E-3
N° 4 (ON)	---	1.907E-3	2.060E-3	4.578E-4	1.602E-3
N° 5 (ON)	---	1.450E-3	9.918E-4	1.450E-3	-7.629E-4
N° 6 (ON)	---	-2.136E-3	-1.678E-3	-1.907E-3	-1.144E-3
N° 7 (OFF)	---	1.907E-3	1.678E-3	5.341E-4	1.450E-3
N° 8 (OFF)	---	1.144E-3	8.392E-4	1.297E-3	-7.629E-4
N° 9 (OFF)	---	-2.289E-4	-1.526E-4	1.450E-3	-6.103E-4
N° 10 (OFF)	---	-8.392E-4	-6.103E-4	-2.288E-4	4.578E-4
N° 11 (OFF)	---	3.051E-4	4.577E-4	-3.815E-4	7.630E-5
Average (ON)	---	-6.104E-5	3.662E-4	2.747E-4	1.831E-4
s (ON)	---	1.760E-3	1.617E-3	1.743E-3	1.633E-3
Average+3s (ON)	---	5.219E-3	5.217E-3	5.503E-3	5.083E-3
Average-3s (ON)	---	-5.341E-3	-4.485E-3	-4.954E-3	-4.717E-3
Average (OFF)	---	4.578E-4	4.425E-4	5.341E-4	1.221E-4
s (OFF)	---	1.090E-3	8.871E-4	8.427E-4	8.940E-4
Average+3s (OFF)	---	3.727E-3	3.104E-3	3.062E-3	2.804E-3
Average-3s (OFF)	---	-2.811E-3	-2.219E-3	-1.994E-3	-2.560E-3

66. IIOI_IO[3]

Ta = 25°C, Vcc = 3.3V, Vout = 0V

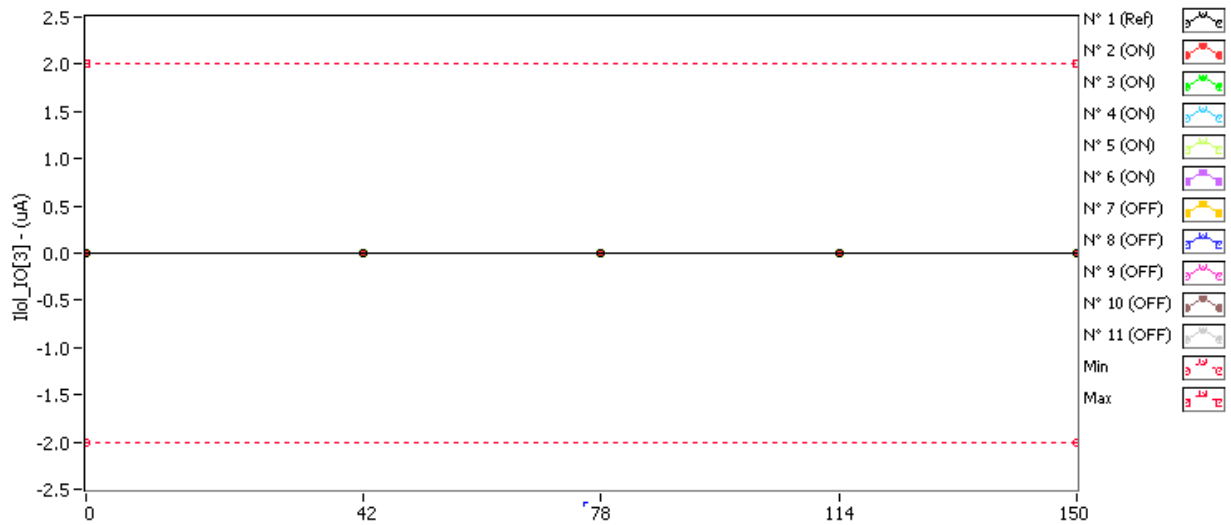

IIOI_IO[3] . (uA) Min = -2.0 Max = 2.0

	0krad(Si)	42krad(Si)	78krad(Si)	114krad(Si)	150krad(Si)
N° 1 (Ref)	1.848E-3	4.751E-4	1.009E-3	1.620E-3	7.040E-4
N° 2 (ON)	1.238E-3	-5.896E-5	2.154E-3	5.514E-4	2.154E-3
N° 3 (ON)	4.751E-4	2.306E-3	2.154E-3	1.696E-3	1.696E-3
N° 4 (ON)	1.925E-3	1.238E-3	2.611E-3	6.277E-4	2.459E-3
N° 5 (ON)	9.329E-4	3.988E-4	1.085E-3	3.988E-4	6.277E-4
N° 6 (ON)	1.314E-3	6.277E-4	5.514E-4	2.230E-3	1.162E-3
N° 7 (OFF)	6.277E-4	7.803E-4	1.696E-3	3.988E-4	1.543E-3
N° 8 (OFF)	3.988E-4	1.733E-5	6.277E-4	4.751E-4	2.001E-3
N° 9 (OFF)	3.225E-4	1.085E-3	5.514E-4	9.329E-4	9.329E-4
N° 10 (OFF)	1.699E-4	4.751E-4	3.225E-4	1.848E-3	1.925E-3
N° 11 (OFF)	2.462E-4	2.462E-4	1.467E-3	7.040E-4	4.751E-4

Delta [IIOI_IO[3]]

	0krad(Si)	42krad(Si)	78krad(Si)	114krad(Si)	150krad(Si)
N° 1 (Ref)	---	-1.373E-3	-8.392E-4	-2.289E-4	-1.144E-3
N° 2 (ON)	---	-1.297E-3	9.156E-4	-6.866E-4	9.156E-4
N° 3 (ON)	---	1.831E-3	1.678E-3	1.221E-3	1.221E-3
N° 4 (ON)	---	-6.867E-4	6.866E-4	-1.297E-3	5.340E-4
N° 5 (ON)	---	-5.341E-4	1.525E-4	-5.341E-4	-3.052E-4
N° 6 (ON)	---	-6.866E-4	-7.629E-4	9.156E-4	-1.526E-4
N° 7 (OFF)	---	1.526E-4	1.068E-3	-2.289E-4	9.155E-4
N° 8 (OFF)	---	-3.815E-4	2.289E-4	7.630E-5	1.602E-3
N° 9 (OFF)	---	7.629E-4	2.289E-4	6.103E-4	6.103E-4
N° 10 (OFF)	---	3.052E-4	1.526E-4	1.678E-3	1.755E-3
N° 11 (OFF)	---	0.000E+0	1.221E-3	4.578E-4	2.289E-4
Average (ON)	---	-2.746E-4	5.341E-4	-7.628E-5	4.425E-4
s (ON)	---	1.213E-3	9.092E-4	1.088E-3	6.616E-4
Average+3s (ON)	---	3.365E-3	3.262E-3	3.189E-3	2.427E-3
Average-3s (ON)	---	-3.914E-3	-2.193E-3	-3.341E-3	-1.542E-3
Average (OFF)	---	1.678E-4	5.798E-4	5.188E-4	1.022E-3
s (OFF)	---	4.193E-4	5.191E-4	7.266E-4	6.487E-4
Average+3s (OFF)	---	1.426E-3	2.137E-3	2.699E-3	2.969E-3
Average-3s (OFF)	---	-1.090E-3	-9.775E-4	-1.661E-3	-9.239E-4

67. IIOI_IO[4]

Ta = 25°C, Vcc = 3.3V, Vout = 0V

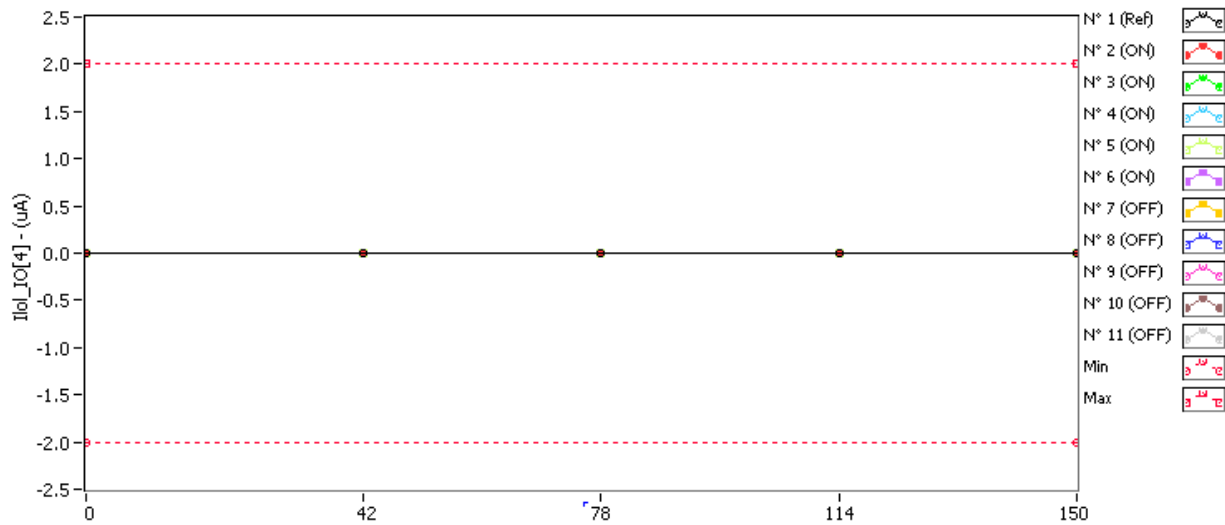

IIOI_IO[4] . (uA) Min = -2.0 Max = 2.0

	0krad(Si)	42krad(Si)	78krad(Si)	114krad(Si)	150krad(Si)
N° 1 (Ref)	6.277E-4	1.925E-3	2.154E-3	1.391E-3	7.040E-4
N° 2 (ON)	2.306E-3	2.840E-3	1.085E-3	2.840E-3	1.696E-3
N° 3 (ON)	1.314E-3	8.566E-4	2.840E-3	1.543E-3	2.993E-3
N° 4 (ON)	1.848E-3	2.535E-3	1.772E-3	2.230E-3	5.514E-4
N° 5 (ON)	2.154E-3	1.238E-3	9.329E-4	1.314E-3	2.306E-3
N° 6 (ON)	2.001E-3	2.459E-3	8.566E-4	2.916E-3	2.916E-3
N° 7 (OFF)	1.162E-3	5.514E-4	1.162E-3	2.001E-3	4.751E-4
N° 8 (OFF)	2.154E-3	2.382E-3	2.382E-3	1.238E-3	2.077E-3
N° 9 (OFF)	2.382E-3	4.751E-4	2.611E-3	1.238E-3	2.001E-3
N° 10 (OFF)	1.620E-3	1.085E-3	2.154E-3	8.566E-4	1.696E-3
N° 11 (OFF)	1.467E-3	2.764E-3	6.277E-4	2.382E-3	1.620E-3

Delta [IIOI_IO[4]]

	0krad(Si)	42krad(Si)	78krad(Si)	114krad(Si)	150krad(Si)
N° 1 (Ref)	---	1.297E-3	1.526E-3	7.629E-4	7.629E-5
N° 2 (ON)	---	5.340E-4	-1.221E-3	5.340E-4	-6.104E-4
N° 3 (ON)	---	-4.577E-4	1.526E-3	2.289E-4	1.678E-3
N° 4 (ON)	---	6.866E-4	-7.630E-5	3.815E-4	-1.297E-3
N° 5 (ON)	---	-9.156E-4	-1.221E-3	-8.393E-4	1.526E-4
N° 6 (ON)	---	4.577E-4	-1.144E-3	9.155E-4	9.155E-4
N° 7 (OFF)	---	-6.103E-4	0.000E+0	8.393E-4	-6.866E-4
N° 8 (OFF)	---	2.288E-4	2.288E-4	-9.156E-4	-7.630E-5
N° 9 (OFF)	---	-1.907E-3	2.289E-4	-1.144E-3	-3.814E-4
N° 10 (OFF)	---	-5.341E-4	5.341E-4	-7.629E-4	7.630E-5
N° 11 (OFF)	---	1.297E-3	-8.392E-4	9.155E-4	1.526E-4
Average (ON)	---	6.099E-5	-4.273E-4	2.441E-4	1.678E-4
s (ON)	---	7.063E-4	1.195E-3	6.572E-4	1.182E-3
Average+3s (ON)	---	2.180E-3	3.158E-3	2.216E-3	3.715E-3
Average-3s (ON)	---	-2.058E-3	-4.012E-3	-1.728E-3	-3.380E-3
Average (OFF)	---	-3.052E-4	3.052E-5	-2.136E-4	-1.831E-4
s (OFF)	---	1.179E-3	5.219E-4	1.006E-3	3.479E-4
Average+3s (OFF)	---	3.233E-3	1.596E-3	2.803E-3	8.607E-4
Average-3s (OFF)	---	-3.844E-3	-1.535E-3	-3.230E-3	-1.227E-3

68. IIOI_IO[5]

Ta = 25°C, Vcc = 3.3V, Vout = 0V

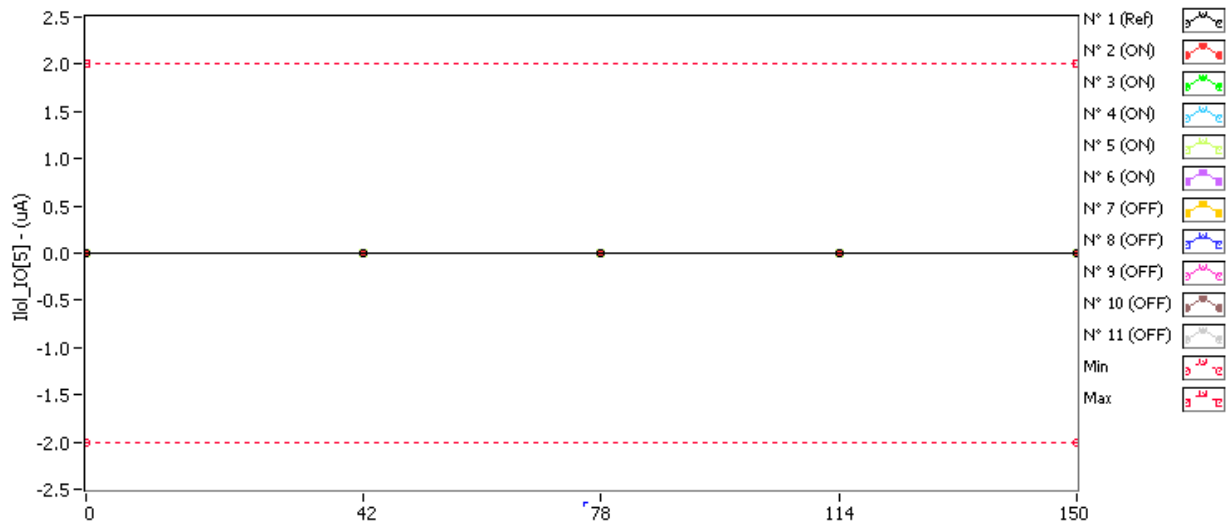

IIOI_IO[5] . (uA) **Min = -2.0 Max = 2.0**

	0krad(Si)	42krad(Si)	78krad(Si)	114krad(Si)	150krad(Si)
N° 1 (Ref)	3.225E-4	3.225E-4	-5.167E-4	1.620E-3	1.314E-3
N° 2 (ON)	1.162E-3	1.733E-5	1.162E-3	3.988E-4	7.803E-4
N° 3 (ON)	2.611E-3	-9.745E-4	9.329E-4	2.001E-3	1.238E-3
N° 4 (ON)	1.772E-3	3.225E-4	1.085E-3	1.772E-3	6.277E-4
N° 5 (ON)	1.238E-3	2.001E-3	1.314E-3	1.925E-3	1.848E-3
N° 6 (ON)	1.314E-3	1.543E-3	-1.353E-4	3.225E-4	2.077E-3
N° 7 (OFF)	1.085E-3	1.925E-3	1.391E-3	4.751E-4	1.238E-3
N° 8 (OFF)	1.733E-5	1.238E-3	1.772E-3	8.566E-4	7.040E-4
N° 9 (OFF)	1.620E-3	2.154E-3	-5.896E-5	1.314E-3	1.620E-3
N° 10 (OFF)	-5.896E-5	-1.353E-4	6.277E-4	2.077E-3	1.733E-5
N° 11 (OFF)	1.009E-3	-1.356E-3	2.462E-4	1.696E-3	2.230E-3

Delta [IIOI_IO[5]]

	0krad(Si)	42krad(Si)	78krad(Si)	114krad(Si)	150krad(Si)
N° 1 (Ref)	---	0.000E+0	-8.392E-4	1.297E-3	9.918E-4
N° 2 (ON)	---	-1.144E-3	0.000E+0	-7.629E-4	-3.814E-4
N° 3 (ON)	---	-3.586E-3	-1.678E-3	-6.103E-4	-1.373E-3
N° 4 (ON)	---	-1.450E-3	-6.867E-4	0.000E+0	-1.144E-3
N° 5 (ON)	---	7.630E-4	7.630E-5	6.867E-4	6.104E-4
N° 6 (ON)	---	2.289E-4	-1.450E-3	-9.918E-4	7.630E-4
N° 7 (OFF)	---	8.393E-4	3.052E-4	-6.103E-4	1.526E-4
N° 8 (OFF)	---	1.221E-3	1.755E-3	8.392E-4	6.866E-4
N° 9 (OFF)	---	5.341E-4	-1.678E-3	-3.052E-4	0.000E+0
N° 10 (OFF)	---	-7.629E-5	6.867E-4	2.136E-3	7.629E-5
N° 11 (OFF)	---	-2.365E-3	-7.630E-4	6.866E-4	1.221E-3
Average (ON)	---	-1.038E-3	-7.477E-4	-3.357E-4	-3.051E-4
s (ON)	---	1.697E-3	8.063E-4	6.794E-4	9.786E-4
Average+3s (ON)	---	4.054E-3	1.671E-3	1.703E-3	2.631E-3
Average-3s (ON)	---	-6.129E-3	-3.167E-3	-2.374E-3	-3.241E-3
Average (OFF)	---	3.052E-5	6.104E-5	5.493E-4	4.272E-4
s (OFF)	---	1.421E-3	1.325E-3	1.084E-3	5.191E-4
Average+3s (OFF)	---	4.293E-3	4.037E-3	3.800E-3	1.985E-3
Average-3s (OFF)	---	-4.232E-3	-3.915E-3	-2.701E-3	-1.130E-3

69. IIOI_IO[6]

Ta = 25°C, Vcc = 3.3V, Vout = 0V

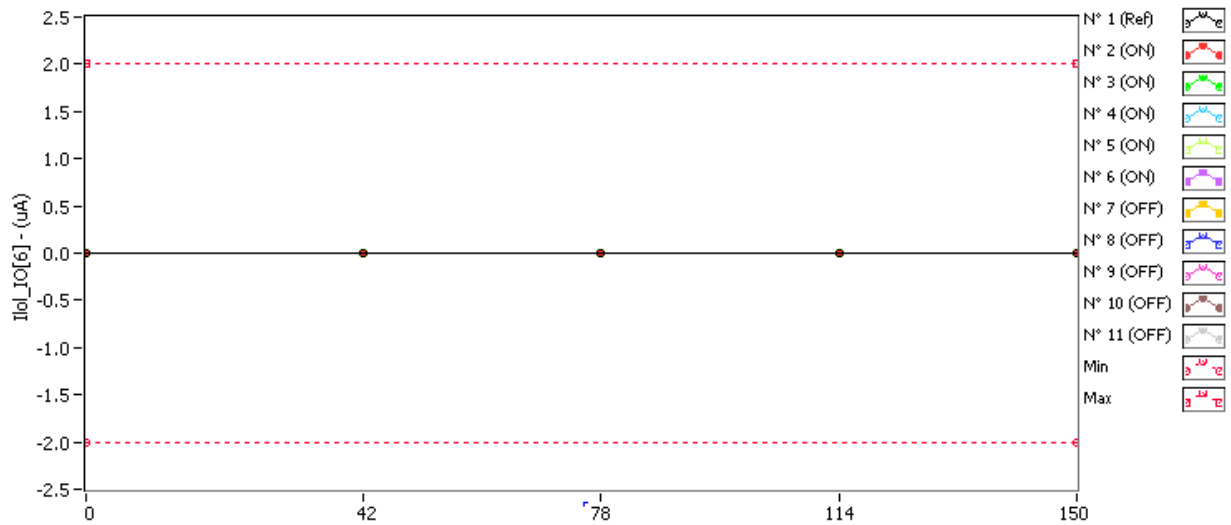

IIOI_IO[6] . (uA) Min = -2.0 Max = 2.0

	0krad(Si)	42krad(Si)	78krad(Si)	114krad(Si)	150krad(Si)
N° 1 (Ref)	2.306E-3	2.764E-3	2.535E-3	2.840E-3	2.840E-3
N° 2 (ON)	2.764E-3	7.040E-4	6.277E-4	2.611E-3	2.230E-3
N° 3 (ON)	2.459E-3	9.363E-5	5.514E-4	8.566E-4	7.803E-4
N° 4 (ON)	9.329E-4	1.772E-3	1.085E-3	8.566E-4	2.535E-3
N° 5 (ON)	6.277E-4	1.085E-3	8.566E-4	1.314E-3	1.467E-3
N° 6 (ON)	1.699E-4	2.001E-3	2.535E-3	2.993E-3	7.803E-4
N° 7 (OFF)	1.772E-3	1.314E-3	2.459E-3	1.848E-3	2.230E-3
N° 8 (OFF)	7.040E-4	1.848E-3	1.009E-3	1.085E-3	1.238E-3
N° 9 (OFF)	6.277E-4	1.848E-3	2.154E-3	2.001E-3	1.391E-3
N° 10 (OFF)	5.514E-4	1.772E-3	7.040E-4	2.230E-3	2.535E-3
N° 11 (OFF)	3.069E-3	2.611E-3	1.162E-3	1.543E-3	9.329E-4

Delta [IIOI_IO[6]]

	0krad(Si)	42krad(Si)	78krad(Si)	114krad(Si)	150krad(Si)
N° 1 (Ref)	---	4.577E-4	2.288E-4	5.340E-4	5.340E-4
N° 2 (ON)	---	-2.060E-3	-2.136E-3	-1.526E-4	-5.340E-4
N° 3 (ON)	---	-2.365E-3	-1.907E-3	-1.602E-3	-1.678E-3
N° 4 (ON)	---	8.392E-4	1.525E-4	-7.629E-5	1.602E-3
N° 5 (ON)	---	4.577E-4	2.289E-4	6.866E-4	8.392E-4
N° 6 (ON)	---	1.831E-3	2.365E-3	2.823E-3	6.103E-4
N° 7 (OFF)	---	-4.578E-4	6.866E-4	7.630E-5	4.578E-4
N° 8 (OFF)	---	1.144E-3	3.052E-4	3.814E-4	5.340E-4
N° 9 (OFF)	---	1.221E-3	1.526E-3	1.373E-3	7.629E-4
N° 10 (OFF)	---	1.221E-3	1.526E-4	1.679E-3	1.984E-3
N° 11 (OFF)	---	-4.578E-4	-1.907E-3	-1.526E-3	-2.136E-3
Average (ON)	---	-2.594E-4	-2.594E-4	3.357E-4	1.679E-4
s (ON)	---	1.855E-3	1.839E-3	1.618E-3	1.285E-3
Average+3s (ON)	---	5.306E-3	5.259E-3	5.190E-3	4.023E-3
Average-3s (ON)	---	-5.825E-3	-5.778E-3	-4.519E-3	-3.687E-3
Average (OFF)	---	5.340E-4	1.526E-4	3.967E-4	3.204E-4
s (OFF)	---	9.060E-4	1.269E-3	1.265E-3	1.505E-3
Average+3s (OFF)	---	3.252E-3	3.959E-3	4.190E-3	4.836E-3
Average-3s (OFF)	---	-2.184E-3	-3.653E-3	-3.397E-3	-4.195E-3

70. Iiol_IO[7]

Ta = 25°C, Vcc = 3.3V, Vout = 0V

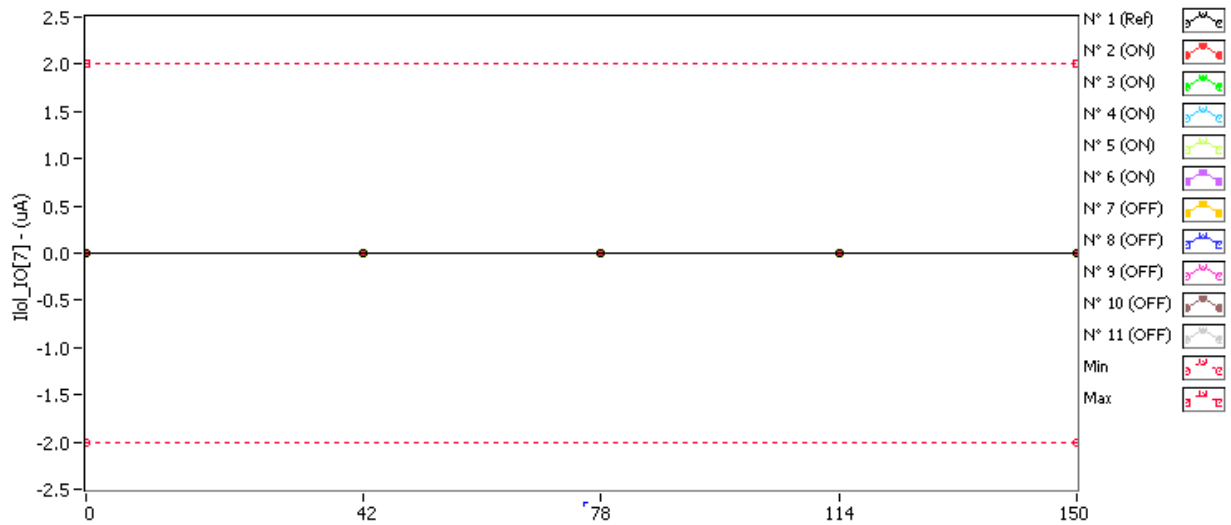

Iiol_IO[7] . (uA) Min = -2.0 Max = 2.0

	0krad(Si)	42krad(Si)	78krad(Si)	114krad(Si)	150krad(Si)
N° 1 (Ref)	2.688E-3	7.040E-4	9.329E-4	2.154E-3	1.772E-3
N° 2 (ON)	2.764E-3	1.925E-3	1.391E-3	2.306E-3	9.329E-4
N° 3 (ON)	2.764E-3	3.222E-3	7.040E-4	2.382E-3	2.840E-3
N° 4 (ON)	2.306E-3	7.803E-4	2.535E-3	2.993E-3	2.154E-3
N° 5 (ON)	1.162E-3	1.925E-3	1.391E-3	2.764E-3	2.306E-3
N° 6 (ON)	1.696E-3	2.688E-3	1.848E-3	2.916E-3	1.543E-3
N° 7 (OFF)	1.696E-3	2.688E-3	9.329E-4	1.162E-3	2.916E-3
N° 8 (OFF)	1.009E-3	1.467E-3	1.238E-3	8.566E-4	2.916E-3
N° 9 (OFF)	1.772E-3	2.611E-3	1.391E-3	2.611E-3	2.306E-3
N° 10 (OFF)	3.298E-3	2.535E-3	1.085E-3	1.009E-3	2.382E-3
N° 11 (OFF)	3.374E-3	2.916E-3	1.391E-3	5.514E-4	2.154E-3

Delta [Iiol_IO[7]]

	0krad(Si)	42krad(Si)	78krad(Si)	114krad(Si)	150krad(Si)
N° 1 (Ref)	---	-1.984E-3	-1.755E-3	-5.340E-4	-9.155E-4
N° 2 (ON)	---	-8.392E-4	-1.373E-3	-4.577E-4	-1.831E-3
N° 3 (ON)	---	4.578E-4	-2.060E-3	-3.815E-4	7.630E-5
N° 4 (ON)	---	-1.526E-3	2.288E-4	6.866E-4	-1.526E-4
N° 5 (ON)	---	7.630E-4	2.289E-4	1.602E-3	1.144E-3
N° 6 (ON)	---	9.918E-4	1.526E-4	1.221E-3	-1.526E-4
N° 7 (OFF)	---	9.918E-4	-7.629E-4	-5.341E-4	1.221E-3
N° 8 (OFF)	---	4.577E-4	2.288E-4	-1.526E-4	1.907E-3
N° 9 (OFF)	---	8.392E-4	-3.815E-4	8.392E-4	5.341E-4
N° 10 (OFF)	---	-7.630E-4	-2.213E-3	-2.289E-3	-9.156E-4
N° 11 (OFF)	---	-4.578E-4	-1.984E-3	-2.823E-3	-1.221E-3
Average (ON)	---	-3.051E-5	-5.646E-4	5.341E-4	-1.831E-4
s (ON)	---	1.096E-3	1.080E-3	9.297E-4	1.066E-3
Average+3s (ON)	---	3.257E-3	2.675E-3	3.323E-3	3.016E-3
Average-3s (ON)	---	-3.318E-3	-3.804E-3	-2.255E-3	-3.382E-3
Average (OFF)	---	2.136E-4	-1.022E-3	-9.918E-4	3.052E-4
s (OFF)	---	7.844E-4	1.047E-3	1.525E-3	1.349E-3
Average+3s (OFF)	---	2.567E-3	2.118E-3	3.583E-3	4.351E-3
Average-3s (OFF)	---	-2.140E-3	-4.163E-3	-5.567E-3	-3.741E-3

71. IIOI_IO[8]

Ta = 25°C, Vcc = 3.3V, Vout = 0V

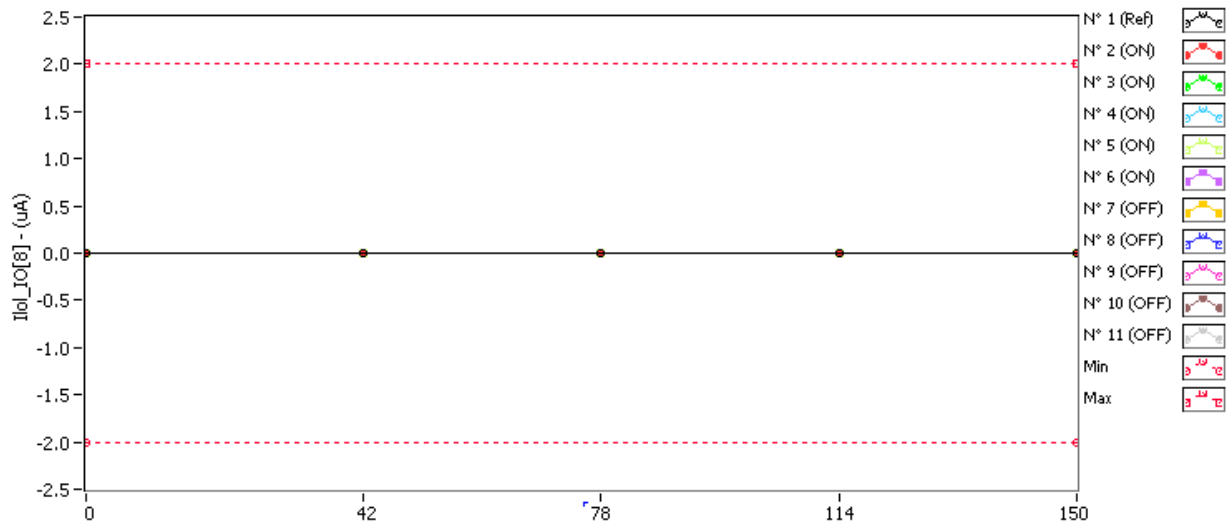

IIOI_IO[8] . (uA) Min = -2.0 Max = 2.0

	0krad(Si)	42krad(Si)	78krad(Si)	114krad(Si)	150krad(Si)
N° 1 (Ref)	2.535E-3	2.382E-3	2.688E-3	2.001E-3	2.535E-3
N° 2 (ON)	2.077E-3	2.535E-3	2.077E-3	2.459E-3	9.329E-4
N° 3 (ON)	9.329E-4	1.085E-3	1.162E-3	1.620E-3	1.925E-3
N° 4 (ON)	1.925E-3	1.314E-3	6.277E-4	2.154E-3	1.620E-3
N° 5 (ON)	2.764E-3	2.459E-3	8.566E-4	2.459E-3	1.238E-3
N° 6 (ON)	1.467E-3	1.009E-3	1.009E-3	1.848E-3	1.733E-5
N° 7 (OFF)	1.543E-3	2.230E-3	7.040E-4	1.925E-3	5.514E-4
N° 8 (OFF)	2.611E-3	2.306E-3	2.154E-3	7.040E-4	2.382E-3
N° 9 (OFF)	7.040E-4	3.988E-4	7.040E-4	2.230E-3	1.925E-3
N° 10 (OFF)	2.764E-3	1.238E-3	1.848E-3	4.751E-4	9.329E-4
N° 11 (OFF)	8.566E-4	8.566E-4	6.277E-4	2.001E-3	1.314E-3

Delta [IIOI_IO[8]]

	0krad(Si)	42krad(Si)	78krad(Si)	114krad(Si)	150krad(Si)
N° 1 (Ref)	---	-1.526E-4	1.526E-4	-5.340E-4	0.000E+0
N° 2 (ON)	---	4.577E-4	0.000E+0	3.814E-4	-1.144E-3
N° 3 (ON)	---	1.525E-4	2.288E-4	6.866E-4	9.918E-4
N° 4 (ON)	---	-6.104E-4	-1.297E-3	2.289E-4	-3.052E-4
N° 5 (ON)	---	-3.052E-4	-1.907E-3	-3.052E-4	-1.526E-3
N° 6 (ON)	---	-4.577E-4	-4.577E-4	3.815E-4	-1.450E-3
N° 7 (OFF)	---	6.867E-4	-8.392E-4	3.815E-4	-9.918E-4
N° 8 (OFF)	---	-3.051E-4	-4.577E-4	-1.907E-3	-2.289E-4
N° 9 (OFF)	---	-3.052E-4	0.000E+0	1.526E-3	1.221E-3
N° 10 (OFF)	---	-1.526E-3	-9.155E-4	-2.289E-3	-1.831E-3
N° 11 (OFF)	---	0.000E+0	-2.289E-4	1.144E-3	4.577E-4
Average (ON)	---	-1.526E-4	-6.866E-4	2.746E-4	-6.867E-4
s (ON)	---	4.448E-4	8.979E-4	3.643E-4	1.056E-3
Average+3s (ON)	---	1.182E-3	2.007E-3	1.368E-3	2.481E-3
Average-3s (ON)	---	-1.487E-3	-3.380E-3	-8.183E-4	-3.854E-3
Average (OFF)	---	-2.899E-4	-4.883E-4	-2.289E-4	-2.747E-4
s (OFF)	---	8.009E-4	3.913E-4	1.761E-3	1.195E-3
Average+3s (OFF)	---	2.113E-3	6.855E-4	5.053E-3	3.310E-3
Average-3s (OFF)	---	-2.693E-3	-1.662E-3	-5.511E-3	-3.859E-3

72. IIOI_IO[9]

Ta = 25°C, Vcc = 3.3V, Vout = 0V

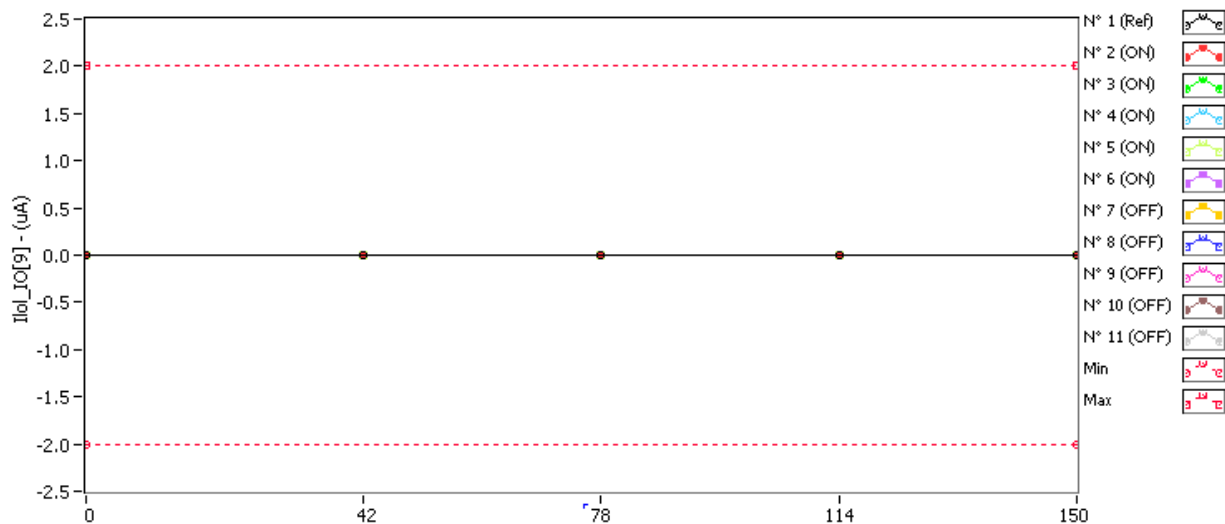

IIOI_IO[9] . (uA) Min = -2.0 Max = 2.0

	0krad(Si)	42krad(Si)	78krad(Si)	114krad(Si)	150krad(Si)
N° 1 (Ref)	2.382E-3	1.772E-3	1.925E-3	2.459E-3	1.314E-3
N° 2 (ON)	2.230E-3	2.535E-3	3.069E-3	1.391E-3	2.077E-3
N° 3 (ON)	7.040E-4	2.230E-3	1.772E-3	2.764E-3	1.009E-3
N° 4 (ON)	1.467E-3	2.688E-3	3.298E-3	1.772E-3	1.467E-3
N° 5 (ON)	1.162E-3	1.391E-3	1.467E-3	1.162E-3	1.467E-3
N° 6 (ON)	3.225E-4	1.238E-3	2.688E-3	1.162E-3	2.688E-3
N° 7 (OFF)	2.764E-3	1.314E-3	1.696E-3	1.772E-3	2.459E-3
N° 8 (OFF)	1.543E-3	2.840E-3	2.077E-3	1.391E-3	2.764E-3
N° 9 (OFF)	2.459E-3	1.772E-3	2.306E-3	2.230E-3	1.314E-3
N° 10 (OFF)	3.145E-3	7.803E-4	1.009E-3	1.772E-3	7.040E-4
N° 11 (OFF)	2.382E-3	2.611E-3	3.298E-3	2.764E-3	1.543E-3

Delta [IIOI_IO[9]]

	0krad(Si)	42krad(Si)	78krad(Si)	114krad(Si)	150krad(Si)
N° 1 (Ref)	---	-6.103E-4	-4.577E-4	7.630E-5	-1.068E-3
N° 2 (ON)	---	3.051E-4	8.392E-4	-8.393E-4	-1.526E-4
N° 3 (ON)	---	1.526E-3	1.068E-3	2.060E-3	3.052E-4
N° 4 (ON)	---	1.221E-3	1.831E-3	3.052E-4	0.000E+0
N° 5 (ON)	---	2.289E-4	3.052E-4	0.000E+0	3.052E-4
N° 6 (ON)	---	9.155E-4	2.365E-3	8.392E-4	2.365E-3
N° 7 (OFF)	---	-1.450E-3	-1.068E-3	-9.918E-4	-3.052E-4
N° 8 (OFF)	---	1.297E-3	5.341E-4	-1.526E-4	1.221E-3
N° 9 (OFF)	---	-6.866E-4	-1.525E-4	-2.288E-4	-1.144E-3
N° 10 (OFF)	---	-2.365E-3	-2.136E-3	-1.373E-3	-2.441E-3
N° 11 (OFF)	---	2.289E-4	9.156E-4	3.815E-4	-8.392E-4
Average (ON)	---	8.392E-4	1.282E-3	4.730E-4	5.646E-4
s (ON)	---	5.658E-4	8.171E-4	1.075E-3	1.026E-3
Average+3s (ON)	---	2.537E-3	3.733E-3	3.699E-3	3.642E-3
Average-3s (ON)	---	-8.583E-4	-1.170E-3	-2.753E-3	-2.513E-3
Average (OFF)	---	-5.951E-4	-3.814E-4	-4.730E-4	-7.019E-4
s (OFF)	---	1.426E-3	1.237E-3	7.022E-4	1.332E-3
Average+3s (OFF)	---	3.682E-3	3.330E-3	1.634E-3	3.293E-3
Average-3s (OFF)	---	-4.872E-3	-4.093E-3	-2.580E-3	-4.697E-3

73. IIOI_IO[10]

Ta = 25°C, Vcc = 3.3V, Vout = 0V

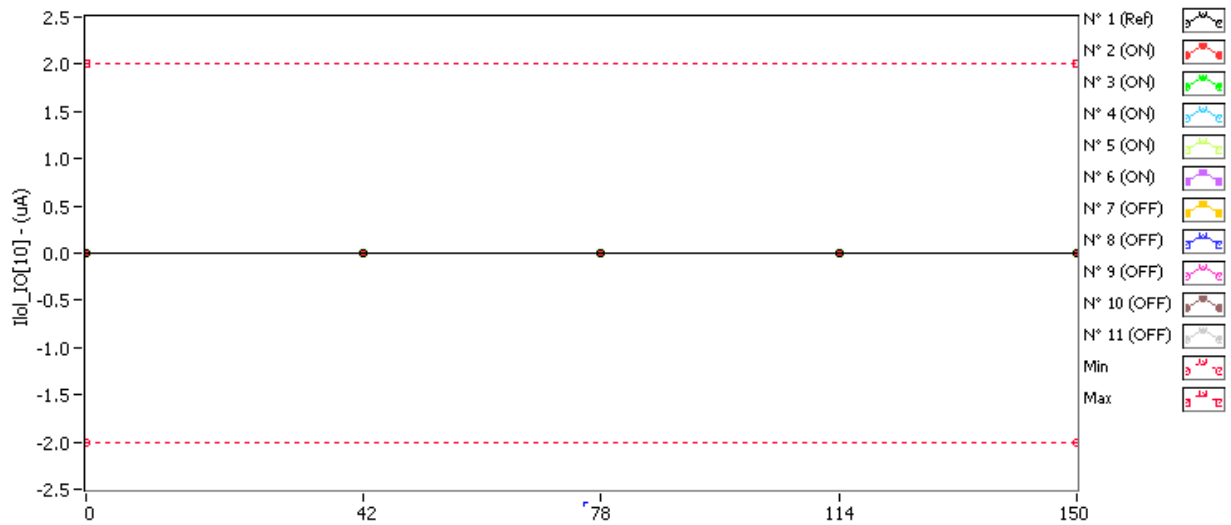

IIOI_IO[10] . (uA) Min = -2.0 Max = 2.0

	0krad(Si)	42krad(Si)	78krad(Si)	114krad(Si)	150krad(Si)
N° 1 (Ref)	2.382E-3	6.277E-4	7.040E-4	6.277E-4	2.459E-3
N° 2 (ON)	9.329E-4	1.009E-3	1.620E-3	7.803E-4	1.848E-3
N° 3 (ON)	1.848E-3	1.925E-3	2.306E-3	4.751E-4	1.314E-3
N° 4 (ON)	-1.353E-4	1.314E-3	7.040E-4	-5.896E-5	7.803E-4
N° 5 (ON)	1.925E-3	2.535E-3	7.040E-4	1.162E-3	2.230E-3
N° 6 (ON)	1.009E-3	2.611E-3	1.543E-3	1.696E-3	1.391E-3
N° 7 (OFF)	2.154E-3	1.925E-3	2.306E-3	3.225E-4	2.382E-3
N° 8 (OFF)	2.459E-3	1.314E-3	1.696E-3	2.459E-3	2.077E-3
N° 9 (OFF)	3.225E-4	4.751E-4	1.467E-3	3.225E-4	1.543E-3
N° 10 (OFF)	1.543E-3	3.145E-3	2.230E-3	1.925E-3	1.543E-3
N° 11 (OFF)	3.988E-4	2.459E-3	1.848E-3	2.001E-3	1.238E-3

Delta [IIOI_IO[10]]

	0krad(Si)	42krad(Si)	78krad(Si)	114krad(Si)	150krad(Si)
N° 1 (Ref)	---	-1.755E-3	-1.678E-3	-1.755E-3	7.630E-5
N° 2 (ON)	---	7.634E-5	6.866E-4	-1.526E-4	9.155E-4
N° 3 (ON)	---	7.630E-5	4.578E-4	-1.373E-3	-5.341E-4
N° 4 (ON)	---	1.450E-3	8.392E-4	7.629E-5	9.155E-4
N° 5 (ON)	---	6.103E-4	-1.221E-3	-7.630E-4	3.052E-4
N° 6 (ON)	---	1.602E-3	5.340E-4	6.866E-4	3.814E-4
N° 7 (OFF)	---	-2.289E-4	1.526E-4	-1.831E-3	2.288E-4
N° 8 (OFF)	---	-1.144E-3	-7.629E-4	0.000E+0	-3.814E-4
N° 9 (OFF)	---	1.526E-4	1.144E-3	0.000E+0	1.221E-3
N° 10 (OFF)	---	1.602E-3	6.867E-4	3.815E-4	0.000E+0
N° 11 (OFF)	---	2.060E-3	1.450E-3	1.602E-3	8.392E-4
Average (ON)	---	7.629E-4	2.594E-4	-3.052E-4	3.967E-4
s (ON)	---	7.317E-4	8.403E-4	7.910E-4	5.944E-4
Average+3s (ON)	---	2.958E-3	2.780E-3	2.068E-3	2.180E-3
Average-3s (ON)	---	-1.432E-3	-2.261E-3	-2.678E-3	-1.387E-3
Average (OFF)	---	4.883E-4	5.341E-4	3.052E-5	3.815E-4
s (OFF)	---	1.323E-3	8.749E-4	1.231E-3	6.451E-4
Average+3s (OFF)	---	4.458E-3	3.159E-3	3.723E-3	2.317E-3
Average-3s (OFF)	---	-3.481E-3	-2.091E-3	-3.662E-3	-1.554E-3

74. IloI_IO[11]

Ta = 25°C, Vcc = 3.3V, Vout = 0V

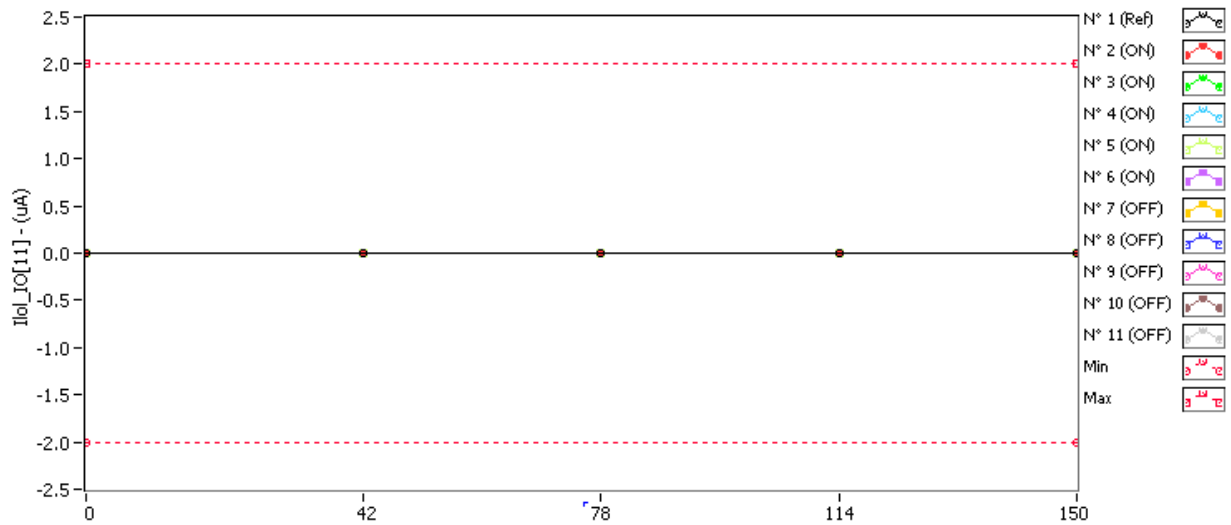

IloI_IO[11] . (uA) Min = -2.0 Max = 2.0

	0krad(Si)	42krad(Si)	78krad(Si)	114krad(Si)	150krad(Si)
N° 1 (Ref)	-4.404E-4	-1.585E-3	1.391E-3	3.988E-4	7.040E-4
N° 2 (ON)	1.391E-3	3.225E-4	7.803E-4	-5.167E-4	1.696E-3
N° 3 (ON)	6.277E-4	9.363E-5	1.848E-3	3.225E-4	9.363E-5
N° 4 (ON)	9.363E-5	-3.641E-4	1.467E-3	1.848E-3	-4.404E-4
N° 5 (ON)	-1.509E-3	1.009E-3	1.238E-3	1.925E-3	1.162E-3
N° 6 (ON)	-1.280E-3	7.803E-4	2.306E-3	-2.878E-4	3.988E-4
N° 7 (OFF)	5.514E-4	-1.509E-3	-7.456E-4	9.363E-5	2.001E-3
N° 8 (OFF)	-7.456E-4	3.988E-4	1.696E-3	1.699E-4	1.696E-3
N° 9 (OFF)	-1.280E-3	1.733E-5	1.314E-3	1.009E-3	-2.115E-4
N° 10 (OFF)	-8.219E-4	-5.167E-4	2.306E-3	1.620E-3	1.543E-3
N° 11 (OFF)	1.699E-4	1.085E-3	1.620E-3	1.543E-3	2.611E-3

Delta [IloI_IO[11]]

	0krad(Si)	42krad(Si)	78krad(Si)	114krad(Si)	150krad(Si)
N° 1 (Ref)	---	-1.144E-3	1.831E-3	8.392E-4	1.144E-3
N° 2 (ON)	---	-1.068E-3	-6.103E-4	-1.907E-3	3.052E-4
N° 3 (ON)	---	-5.341E-4	1.221E-3	-3.052E-4	-5.341E-4
N° 4 (ON)	---	-4.578E-4	1.373E-3	1.755E-3	-5.341E-4
N° 5 (ON)	---	2.518E-3	2.746E-3	3.433E-3	2.670E-3
N° 6 (ON)	---	2.060E-3	3.586E-3	9.919E-4	1.678E-3
N° 7 (OFF)	---	-2.060E-3	-1.297E-3	-4.578E-4	1.450E-3
N° 8 (OFF)	---	1.144E-3	2.441E-3	9.155E-4	2.441E-3
N° 9 (OFF)	---	1.297E-3	2.594E-3	2.289E-3	1.068E-3
N° 10 (OFF)	---	3.052E-4	3.128E-3	2.441E-3	2.365E-3
N° 11 (OFF)	---	9.155E-4	1.450E-3	1.373E-3	2.441E-3
Average (ON)	---	5.035E-4	1.663E-3	7.935E-4	7.172E-4
s (ON)	---	1.655E-3	1.606E-3	2.027E-3	1.418E-3
Average+3s (ON)	---	5.467E-3	6.482E-3	6.874E-3	4.970E-3
Average-3s (ON)	---	-4.460E-3	-3.155E-3	-5.287E-3	-3.536E-3
Average (OFF)	---	3.204E-4	1.663E-3	1.312E-3	1.953E-3
s (OFF)	---	1.383E-3	1.763E-3	1.175E-3	6.487E-4
Average+3s (OFF)	---	4.470E-3	6.951E-3	4.837E-3	3.899E-3
Average-3s (OFF)	---	-3.829E-3	-3.624E-3	-2.213E-3	7.030E-6

75. IIOI_IO[12]

Ta = 25°C, Vcc = 3.3V, Vout = 0V

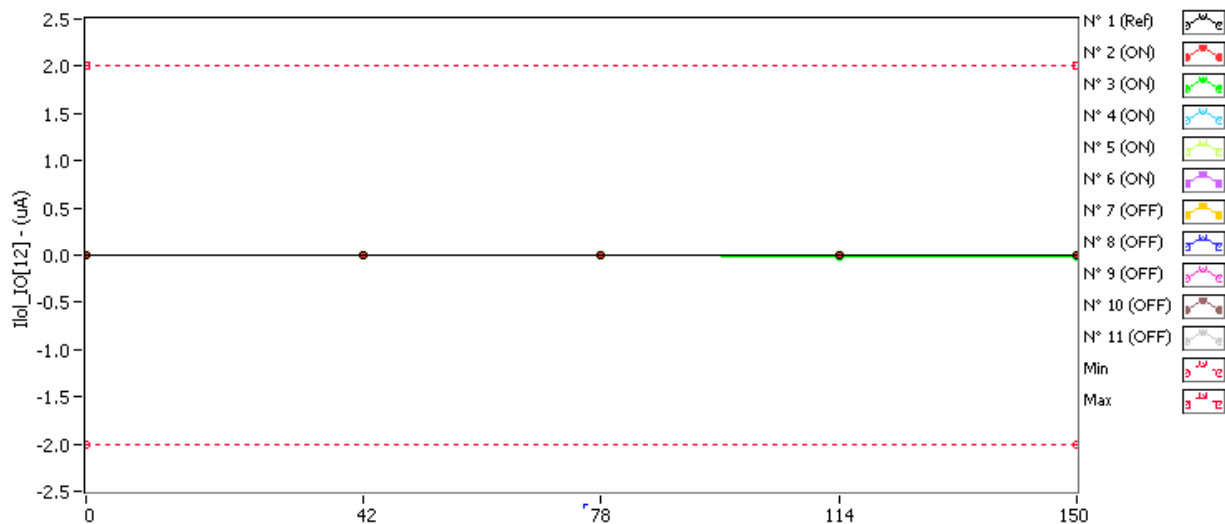

IIOI_IO[12] . (uA) Min = -2.0 Max = 2.0

	0krad(Si)	42krad(Si)	78krad(Si)	114krad(Si)	150krad(Si)
N° 1 (Ref)	2.306E-3	1.925E-3	2.077E-3	3.222E-3	2.993E-3
N° 2 (ON)	1.848E-3	2.535E-3	3.222E-3	2.688E-3	1.391E-3
N° 3 (ON)	1.009E-3	9.329E-4	3.069E-3	-2.188E-2	-1.585E-2
N° 4 (ON)	2.077E-3	3.145E-3	1.238E-3	1.009E-3	3.222E-3
N° 5 (ON)	1.238E-3	2.993E-3	8.566E-4	1.467E-3	2.688E-3
N° 6 (ON)	4.751E-4	1.467E-3	2.764E-3	2.382E-3	2.306E-3
N° 7 (OFF)	2.459E-3	2.688E-3	2.306E-3	2.230E-3	2.382E-3
N° 8 (OFF)	1.848E-3	1.009E-3	1.543E-3	2.764E-3	2.840E-3
N° 9 (OFF)	2.459E-3	1.696E-3	1.314E-3	1.543E-3	2.077E-3
N° 10 (OFF)	2.459E-3	1.238E-3	1.314E-3	2.230E-3	3.527E-3
N° 11 (OFF)	1.467E-3	1.772E-3	2.764E-3	1.238E-3	3.145E-3

Delta [IIOI_IO[12]]

	0krad(Si)	42krad(Si)	78krad(Si)	114krad(Si)	150krad(Si)
N° 1 (Ref)	---	-3.815E-4	-2.289E-4	9.155E-4	6.866E-4
N° 2 (ON)	---	6.866E-4	1.373E-3	8.392E-4	-4.578E-4
N° 3 (ON)	---	-7.634E-5	2.060E-3	-2.289E-2	-1.686E-2
N° 4 (ON)	---	1.068E-3	-8.393E-4	-1.068E-3	1.144E-3
N° 5 (ON)	---	1.755E-3	-3.814E-4	2.289E-4	1.450E-3
N° 6 (ON)	---	9.918E-4	2.289E-3	1.907E-3	1.831E-3
N° 7 (OFF)	---	2.289E-4	-1.525E-4	-2.288E-4	-7.630E-5
N° 8 (OFF)	---	-8.392E-4	-3.052E-4	9.155E-4	9.918E-4
N° 9 (OFF)	---	-7.629E-4	-1.144E-3	-9.155E-4	-3.814E-4
N° 10 (OFF)	---	-1.221E-3	-1.144E-3	-2.288E-4	1.068E-3
N° 11 (OFF)	---	3.052E-4	1.297E-3	-2.289E-4	1.679E-3
Average (ON)	---	8.850E-4	9.003E-4	-4.196E-3	-2.579E-3
s (ON)	---	6.643E-4	1.429E-3	1.050E-2	8.032E-3
Average+3s (ON)	---	2.878E-3	5.187E-3	2.732E-2	2.152E-2
Average-3s (ON)	---	-1.108E-3	-3.386E-3	-3.571E-2	-2.667E-2
Average (OFF)	---	-4.577E-4	-2.899E-4	-1.373E-4	6.562E-4
s (OFF)	---	6.845E-4	9.997E-4	6.594E-4	8.574E-4
Average+3s (OFF)	---	1.596E-3	2.709E-3	1.841E-3	3.228E-3
Average-3s (OFF)	---	-2.511E-3	-3.289E-3	-2.115E-3	-1.916E-3

76. IIOI_IO[13]

Ta = 25°C, Vcc = 3.3V, Vout = 0V

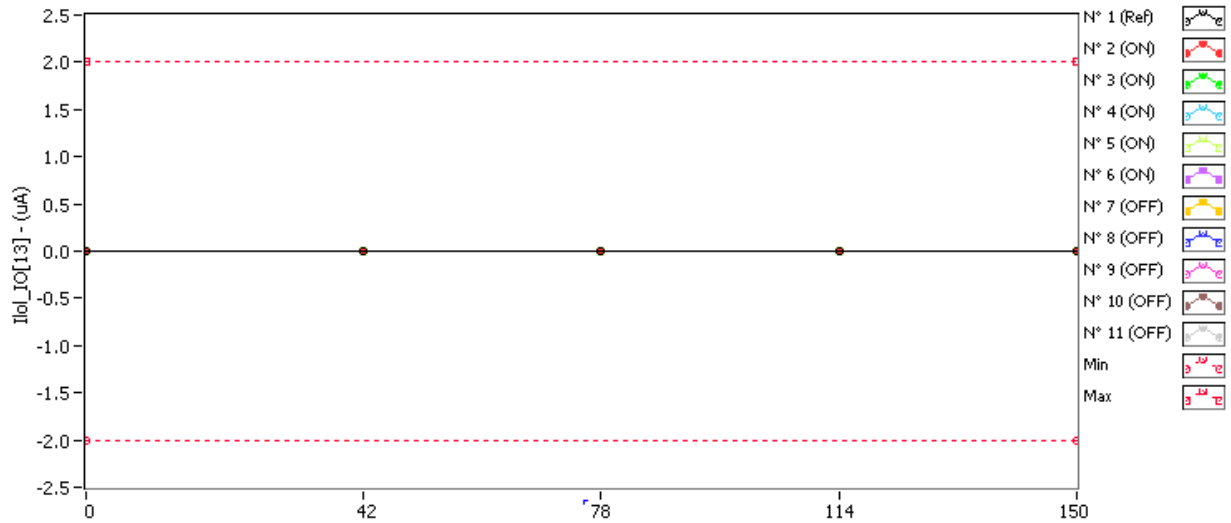

IIOI_IO[13] . (uA) Min = -2.0 Max = 2.0

	0krad(Si)	42krad(Si)	78krad(Si)	114krad(Si)	150krad(Si)
N° 1 (Ref)	-5.896E-5	1.314E-3	1.543E-3	1.733E-5	2.462E-4
N° 2 (ON)	1.696E-3	-3.641E-4	2.154E-3	4.751E-4	1.391E-3
N° 3 (ON)	-5.896E-5	1.696E-3	-1.353E-4	2.230E-3	-2.878E-4
N° 4 (ON)	2.154E-3	1.238E-3	5.514E-4	1.238E-3	4.751E-4
N° 5 (ON)	1.009E-3	1.772E-3	-2.878E-4	2.462E-4	1.699E-4
N° 6 (ON)	9.363E-5	6.277E-4	2.306E-3	-1.353E-4	-5.167E-4
N° 7 (OFF)	2.230E-3	1.696E-3	2.462E-4	1.009E-3	2.154E-3
N° 8 (OFF)	9.363E-5	1.620E-3	1.467E-3	1.772E-3	1.772E-3
N° 9 (OFF)	-3.641E-4	1.772E-3	1.238E-3	2.001E-3	1.620E-3
N° 10 (OFF)	1.467E-3	1.467E-3	1.772E-3	7.803E-4	2.462E-4
N° 11 (OFF)	1.543E-3	1.772E-3	1.772E-3	1.699E-4	1.467E-3

Delta [IIOI_IO[13]]

	0krad(Si)	42krad(Si)	78krad(Si)	114krad(Si)	150krad(Si)
N° 1 (Ref)	---	1.373E-3	1.602E-3	7.629E-5	3.052E-4
N° 2 (ON)	---	-2.060E-3	4.578E-4	-1.221E-3	-3.052E-4
N° 3 (ON)	---	1.755E-3	-7.629E-5	2.289E-3	-2.289E-4
N° 4 (ON)	---	-9.156E-4	-1.602E-3	-9.156E-4	-1.678E-3
N° 5 (ON)	---	7.629E-4	-1.297E-3	-7.630E-4	-8.393E-4
N° 6 (ON)	---	5.341E-4	2.213E-3	-2.289E-4	-6.103E-4
N° 7 (OFF)	---	-5.341E-4	-1.984E-3	-1.221E-3	-7.630E-5
N° 8 (OFF)	---	1.526E-3	1.373E-3	1.678E-3	1.678E-3
N° 9 (OFF)	---	2.136E-3	1.602E-3	2.365E-3	1.984E-3
N° 10 (OFF)	---	0.000E+0	3.052E-4	-6.866E-4	-1.221E-3
N° 11 (OFF)	---	2.289E-4	2.289E-4	-1.373E-3	-7.630E-5
Average (ON)	---	1.524E-5	-6.103E-5	-1.679E-4	-7.324E-4
s (ON)	---	1.502E-3	1.528E-3	1.420E-3	5.825E-4
Average+3s (ON)	---	4.522E-3	4.524E-3	4.091E-3	1.015E-3
Average-3s (ON)	---	-4.491E-3	-4.646E-3	-4.427E-3	-2.480E-3
Average (OFF)	---	6.714E-4	3.052E-4	1.526E-4	4.578E-4
s (OFF)	---	1.115E-3	1.420E-3	1.742E-3	1.342E-3
Average+3s (OFF)	---	4.017E-3	4.566E-3	5.379E-3	4.484E-3
Average-3s (OFF)	---	-2.675E-3	-3.955E-3	-5.074E-3	-3.569E-3

77. IIOI_IO[14]

Ta = 25°C, Vcc = 3.3V, Vout = 0V

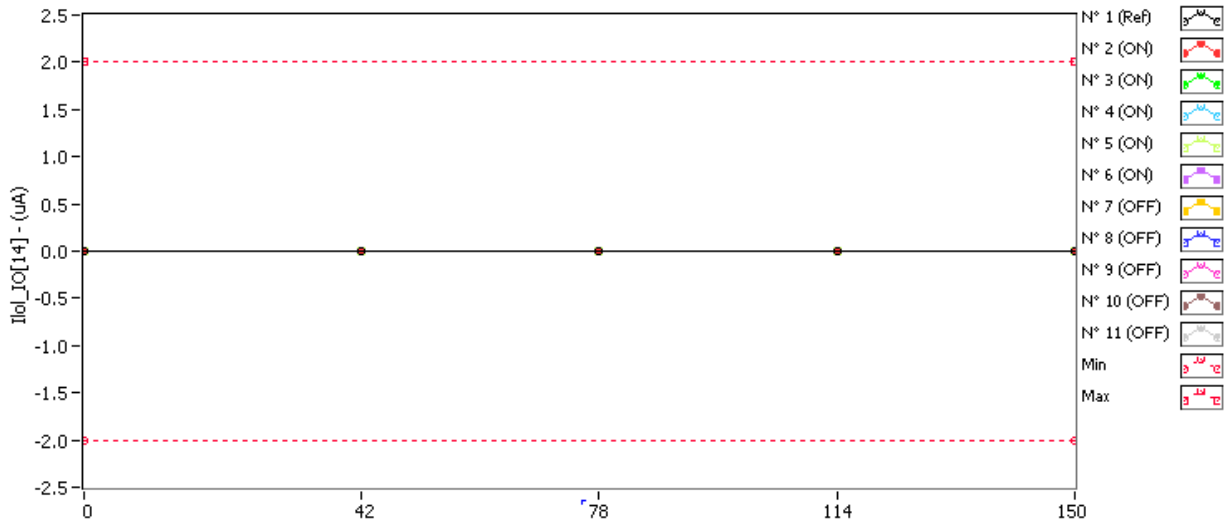

IIOI_IO[14] . (uA) Min = -2.0 Max = 2.0

	0krad(Si)	42krad(Si)	78krad(Si)	114krad(Si)	150krad(Si)
N° 1 (Ref)	1.391E-3	1.238E-3	1.543E-3	7.803E-4	1.925E-3
N° 2 (ON)	2.462E-4	2.230E-3	1.467E-3	1.391E-3	1.772E-3
N° 3 (ON)	-6.693E-4	-2.878E-4	8.566E-4	2.154E-3	2.001E-3
N° 4 (ON)	1.696E-3	1.620E-3	1.391E-3	2.611E-3	2.535E-3
N° 5 (ON)	1.085E-3	1.699E-4	7.803E-4	7.803E-4	7.803E-4
N° 6 (ON)	1.238E-3	7.040E-4	6.277E-4	4.751E-4	1.238E-3
N° 7 (OFF)	1.620E-3	1.699E-4	4.751E-4	9.329E-4	6.277E-4
N° 8 (OFF)	1.238E-3	2.462E-4	2.230E-3	1.772E-3	2.382E-3
N° 9 (OFF)	1.543E-3	-3.641E-4	1.925E-3	1.238E-3	3.225E-4
N° 10 (OFF)	3.225E-4	-9.745E-4	2.230E-3	1.733E-5	7.803E-4
N° 11 (OFF)	1.733E-5	2.535E-3	6.277E-4	1.009E-3	4.751E-4

Delta [IIOI_IO[14]]

	0krad(Si)	42krad(Si)	78krad(Si)	114krad(Si)	150krad(Si)
N° 1 (Ref)	---	-1.526E-4	1.526E-4	-6.103E-4	5.341E-4
N° 2 (ON)	---	1.984E-3	1.221E-3	1.144E-3	1.526E-3
N° 3 (ON)	---	3.815E-4	1.526E-3	2.823E-3	2.670E-3
N° 4 (ON)	---	-7.630E-5	-3.052E-4	9.155E-4	8.392E-4
N° 5 (ON)	---	-9.155E-4	-3.051E-4	-3.051E-4	-3.051E-4
N° 6 (ON)	---	-5.340E-4	-6.103E-4	-7.629E-4	0.000E+0
N° 7 (OFF)	---	-1.450E-3	-1.144E-3	-6.866E-4	-9.918E-4
N° 8 (OFF)	---	-9.918E-4	9.919E-4	5.341E-4	1.144E-3
N° 9 (OFF)	---	-1.907E-3	3.815E-4	-3.052E-4	-1.221E-3
N° 10 (OFF)	---	-1.297E-3	1.907E-3	-3.052E-4	4.578E-4
N° 11 (OFF)	---	2.518E-3	6.104E-4	9.919E-4	4.578E-4
Average (ON)	---	1.679E-4	3.052E-4	7.630E-4	9.461E-4
s (ON)	---	1.126E-3	9.889E-4	1.404E-3	1.202E-3
Average+3s (ON)	---	3.545E-3	3.272E-3	4.974E-3	4.553E-3
Average-3s (ON)	---	-3.209E-3	-2.661E-3	-3.448E-3	-2.661E-3
Average (OFF)	---	-6.256E-4	5.493E-4	4.579E-5	-3.051E-5
s (OFF)	---	1.788E-3	1.111E-3	6.922E-4	1.024E-3
Average+3s (OFF)	---	4.738E-3	3.884E-3	2.122E-3	3.043E-3
Average-3s (OFF)	---	-5.989E-3	-2.785E-3	-2.031E-3	-3.104E-3

78. IIOI_IO[15]

Ta = 25°C, Vcc = 3.3V, Vout = 0V

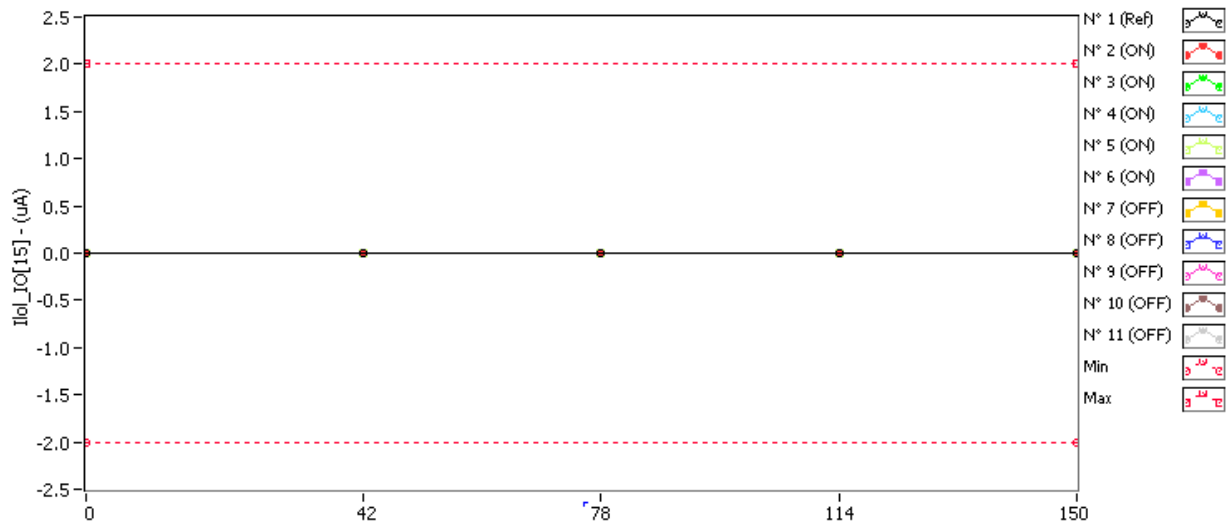

IIOI_IO[15] . (uA) Min = -2.0 Max = 2.0

	0krad(Si)	42krad(Si)	78krad(Si)	114krad(Si)	150krad(Si)
N° 1 (Ref)	2.916E-3	2.154E-3	1.085E-3	1.009E-3	2.764E-3
N° 2 (ON)	2.382E-3	2.154E-3	2.916E-3	1.848E-3	1.162E-3
N° 3 (ON)	3.222E-3	2.459E-3	3.145E-3	1.620E-3	2.764E-3
N° 4 (ON)	2.764E-3	1.085E-3	2.306E-3	1.772E-3	1.085E-3
N° 5 (ON)	2.154E-3	2.993E-3	1.009E-3	1.162E-3	2.459E-3
N° 6 (ON)	1.620E-3	2.840E-3	1.009E-3	2.993E-3	3.374E-3
N° 7 (OFF)	2.154E-3	3.069E-3	2.001E-3	7.803E-4	1.543E-3
N° 8 (OFF)	2.611E-3	1.162E-3	9.329E-4	1.467E-3	2.840E-3
N° 9 (OFF)	2.611E-3	8.566E-4	2.306E-3	3.222E-3	2.001E-3
N° 10 (OFF)	1.391E-3	1.696E-3	1.925E-3	1.925E-3	2.764E-3
N° 11 (OFF)	1.162E-3	2.001E-3	1.314E-3	2.688E-3	3.069E-3

Delta [IIOI_IO[15]]

	0krad(Si)	42krad(Si)	78krad(Si)	114krad(Si)	150krad(Si)
N° 1 (Ref)	---	-7.629E-4	-1.831E-3	-1.907E-3	-1.526E-4
N° 2 (ON)	---	-2.288E-4	5.341E-4	-5.340E-4	-1.221E-3
N° 3 (ON)	---	-7.630E-4	-7.630E-5	-1.602E-3	-4.578E-4
N° 4 (ON)	---	-1.679E-3	-4.577E-4	-9.918E-4	-1.679E-3
N° 5 (ON)	---	8.392E-4	-1.144E-3	-9.919E-4	3.051E-4
N° 6 (ON)	---	1.221E-3	-6.103E-4	1.373E-3	1.755E-3
N° 7 (OFF)	---	9.155E-4	-1.526E-4	-1.373E-3	-6.104E-4
N° 8 (OFF)	---	-1.450E-3	-1.678E-3	-1.144E-3	2.289E-4
N° 9 (OFF)	---	-1.755E-3	-3.051E-4	6.104E-4	-6.103E-4
N° 10 (OFF)	---	3.052E-4	5.341E-4	5.341E-4	1.373E-3
N° 11 (OFF)	---	8.393E-4	1.526E-4	1.526E-3	1.907E-3
Average (ON)	---	-1.221E-4	-3.509E-4	-5.493E-4	-2.594E-4
s (ON)	---	1.180E-3	6.259E-4	1.140E-3	1.356E-3
Average+3s (ON)	---	3.419E-3	1.527E-3	2.870E-3	3.808E-3
Average-3s (ON)	---	-3.663E-3	-2.229E-3	-3.969E-3	-4.327E-3
Average (OFF)	---	-2.289E-4	-2.899E-4	3.053E-5	4.578E-4
s (OFF)	---	1.280E-3	8.399E-4	1.243E-3	1.148E-3
Average+3s (OFF)	---	3.611E-3	2.230E-3	3.759E-3	3.902E-3
Average-3s (OFF)	---	-4.069E-3	-2.810E-3	-3.698E-3	-2.987E-3

79. Icc_Read_20MHz

Ta = 25°C, Vcc = 3.3V, Vih = 2.0V, Vil = 0.8V, #CS = Vil, Read cycle : 20MHz

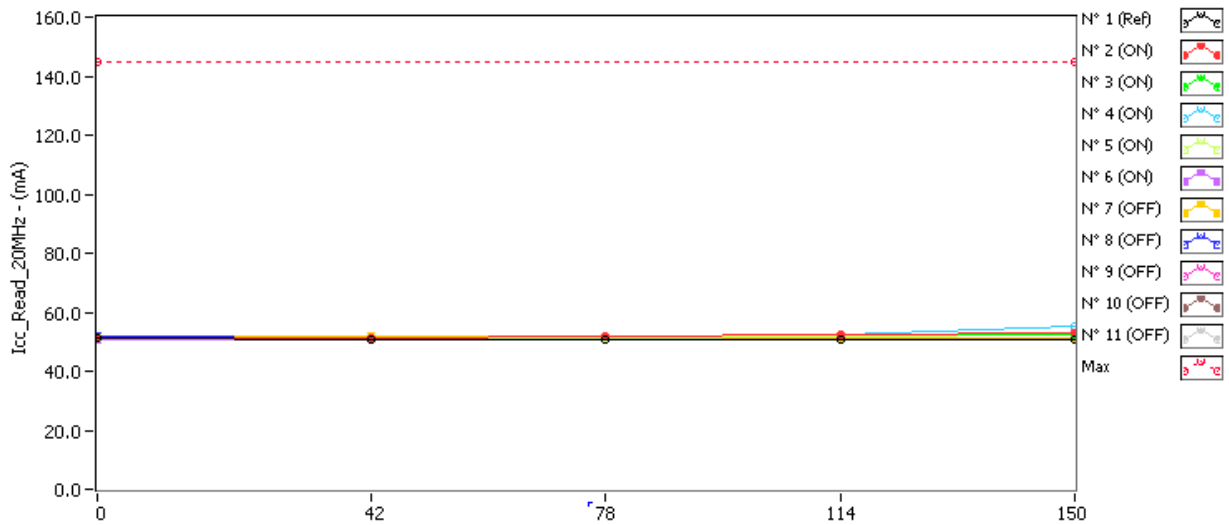

Icc_Read_20MHz . (mA) Max = 145.0

	0krad(Si)	42krad(Si)	78krad(Si)	114krad(Si)	150krad(Si)
N° 1 (Ref)	51.02	50.78	50.84	50.72	50.72
N° 2 (ON)	51.39	51.27	51.70	52.25	52.80
N° 3 (ON)	51.51	51.39	51.76	52.31	52.67
N° 4 (ON)	51.33	51.45	52.00	52.55	55.48
N° 5 (ON)	51.21	51.15	51.51	52.00	52.61
N° 6 (ON)	50.90	51.27	51.51	52.06	52.73
N° 7 (OFF)	51.51	51.58	51.45	51.39	51.39
N° 8 (OFF)	51.76	51.33	51.51	51.45	51.39
N° 9 (OFF)	51.58	51.33	51.39	51.51	51.39
N° 10 (OFF)	50.48	51.27	51.51	51.39	51.21
N° 11 (OFF)	51.33	51.21	51.33	51.33	51.21

Delta [Icc_Read_20MHz]

	0krad(Si)	42krad(Si)	78krad(Si)	114krad(Si)	150krad(Si)
N° 1 (Ref)	---	-2.440E-1	-1.830E-1	-3.050E-1	-3.050E-1
N° 2 (ON)	---	-1.220E-1	3.050E-1	8.540E-1	1.403E+0
N° 3 (ON)	---	-1.220E-1	2.440E-1	7.930E-1	1.159E+0
N° 4 (ON)	---	1.220E-1	6.710E-1	1.220E+0	4.150E+0
N° 5 (ON)	---	-6.100E-2	3.060E-1	7.940E-1	1.404E+0
N° 6 (ON)	---	3.670E-1	6.110E-1	1.160E+0	1.831E+0
N° 7 (OFF)	---	6.100E-2	-6.100E-2	-1.220E-1	-1.220E-1
N° 8 (OFF)	---	-4.270E-1	-2.440E-1	-3.050E-1	-3.660E-1
N° 9 (OFF)	---	-2.440E-1	-1.830E-1	-6.100E-2	-1.830E-1
N° 10 (OFF)	---	7.940E-1	1.038E+0	9.160E-1	7.320E-1
N° 11 (OFF)	---	-1.230E-1	0.000E+0	0.000E+0	-1.230E-1
Average (ON)	---	3.680E-2	4.274E-1	9.642E-1	1.989E+0
s (ON)	---	2.099E-1	1.977E-1	2.087E-1	1.232E+0
Average+3s (ON)	---	6.666E-1	1.021E+0	1.590E+0	5.685E+0
Average-3s (ON)	---	-5.930E-1	-1.658E-1	3.382E-1	-1.706E+0
Average (OFF)	---	1.220E-2	1.100E-1	8.560E-2	-1.240E-2
s (OFF)	---	4.718E-1	5.277E-1	4.780E-1	4.279E-1
Average+3s (OFF)	---	1.428E+0	1.693E+0	1.520E+0	1.271E+0
Average-3s (OFF)	---	-1.403E+0	-1.473E+0	-1.348E+0	-1.296E+0

80. Icc_Write_20MHz

Ta = 25°C, Vcc = 3.3V, Vih = 2.0V, Vil = 0.8V, #CS = Vil, Write cycle : 20MHz

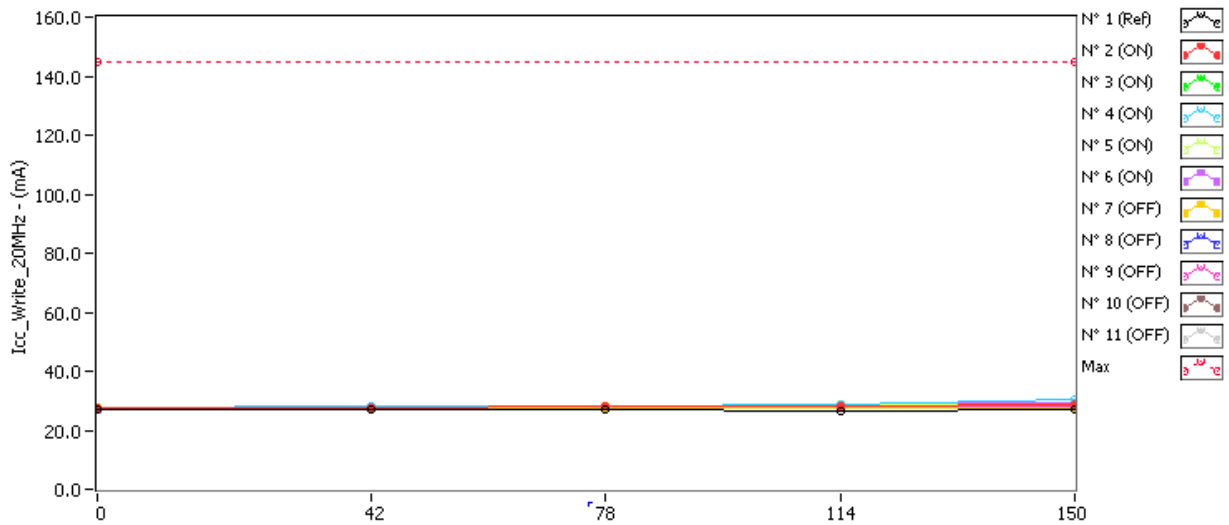

Icc_Write_20MHz . (mA) Max = 145.0

	0krad(Si)	42krad(Si)	78krad(Si)	114krad(Si)	150krad(Si)
N° 1 (Ref)	26.86	26.98	26.92	26.73	27.04
N° 2 (ON)	27.59	27.65	28.14	28.44	28.99
N° 3 (ON)	27.28	27.47	27.95	28.26	28.62
N° 4 (ON)	27.83	28.08	28.44	28.81	30.33
N° 5 (ON)	27.47	27.77	28.26	28.62	28.99
N° 6 (ON)	26.92	27.83	28.14	28.56	29.05
N° 7 (OFF)	27.53	27.59	27.71	27.65	27.53
N° 8 (OFF)	27.16	27.34	27.41	27.41	27.34
N° 9 (OFF)	27.65	27.89	28.02	28.08	28.02
N° 10 (OFF)	26.79	27.53	27.59	27.53	27.53
N° 11 (OFF)	27.10	27.22	27.34	27.34	27.28

Delta [Icc_Write_20MHz]

	0krad(Si)	42krad(Si)	78krad(Si)	114krad(Si)	150krad(Si)
N° 1 (Ref)	---	1.230E-1	6.200E-2	-1.220E-1	1.840E-1
N° 2 (ON)	---	6.100E-2	5.490E-1	8.540E-1	1.404E+0
N° 3 (ON)	---	1.830E-1	6.710E-1	9.760E-1	1.342E+0
N° 4 (ON)	---	2.440E-1	6.100E-1	9.770E-1	2.502E+0
N° 5 (ON)	---	3.050E-1	7.930E-1	1.159E+0	1.526E+0
N° 6 (ON)	---	9.150E-1	1.220E+0	1.647E+0	2.136E+0
N° 7 (OFF)	---	6.100E-2	1.830E-1	1.220E-1	0.000E+0
N° 8 (OFF)	---	1.830E-1	2.440E-1	2.440E-1	1.830E-1
N° 9 (OFF)	---	2.440E-1	3.660E-1	4.270E-1	3.660E-1
N° 10 (OFF)	---	7.330E-1	7.940E-1	7.330E-1	7.330E-1
N° 11 (OFF)	---	1.220E-1	2.440E-1	2.440E-1	1.830E-1
Average (ON)	---	3.416E-1	7.686E-1	1.123E+0	1.782E+0
s (ON)	---	3.330E-1	2.680E-1	3.127E-1	5.113E-1
Average+3s (ON)	---	1.341E+0	1.573E+0	2.061E+0	3.316E+0
Average-3s (ON)	---	-6.574E-1	-3.535E-2	1.845E-1	2.481E-1
Average (OFF)	---	2.686E-1	3.662E-1	3.540E-1	2.930E-1
s (OFF)	---	2.684E-1	2.482E-1	2.382E-1	2.779E-1
Average+3s (OFF)	---	1.074E+0	1.111E+0	1.069E+0	1.127E+0
Average-3s (OFF)	---	-5.366E-1	-3.784E-1	-3.607E-1	-5.408E-1

81. Isb_H

Ta = 25°C, Vcc = 3.3V, Vih = 2.0V, Vil = 0.8V, #CS = Vih, Other inputs = Vih

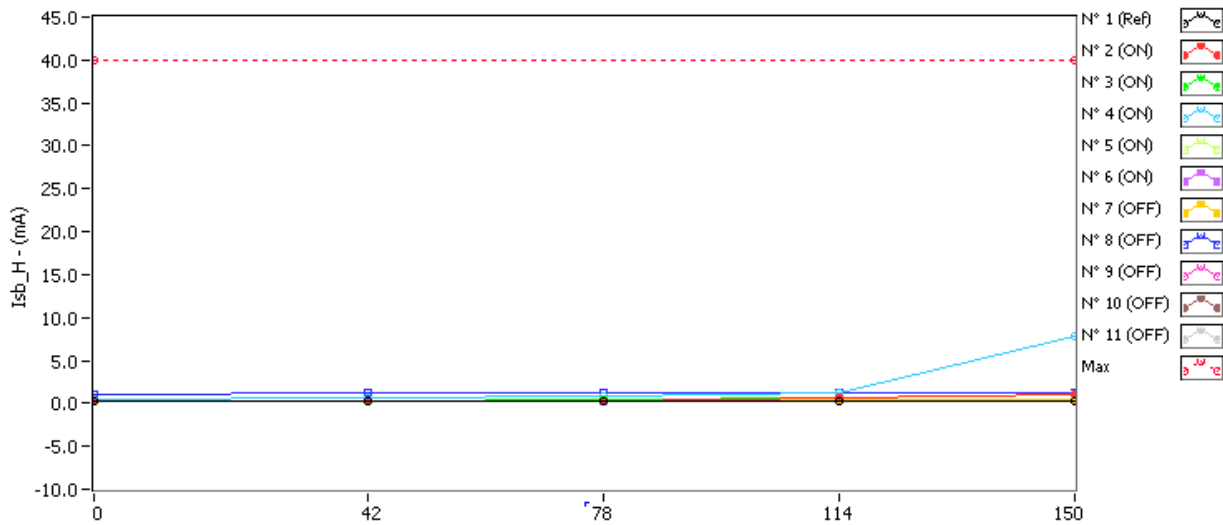

Isb_H . (mA) Max = 40.0

	0krad(Si)	42krad(Si)	78krad(Si)	114krad(Si)	150krad(Si)
N° 1 (Ref)	0.200	0.198	0.197	0.195	0.183
N° 2 (ON)	0.168	0.188	0.319	0.641	0.969
N° 3 (ON)	0.276	0.351	0.447	0.717	1.044
N° 4 (ON)	0.510	0.688	0.841	1.247	7.739
N° 5 (ON)	0.217	0.267	0.391	0.674	1.012
N° 6 (ON)	0.201	0.243	0.360	0.638	0.966
N° 7 (OFF)	0.288	0.356	0.372	0.398	0.420
N° 8 (OFF)	1.041	1.149	1.143	1.167	1.184
N° 9 (OFF)	0.172	0.206	0.201	0.204	0.198
N° 10 (OFF)	0.296	0.360	0.352	0.354	0.356
N° 11 (OFF)	0.229	0.262	0.250	0.264	0.270

Delta [Isb_H]

	0krad(Si)	42krad(Si)	78krad(Si)	114krad(Si)	150krad(Si)
N° 1 (Ref)	---	-1.530E-3	-3.050E-3	-4.580E-3	-1.678E-2
N° 2 (ON)	---	1.983E-2	1.511E-1	4.730E-1	8.011E-1
N° 3 (ON)	---	7.477E-2	1.709E-1	4.410E-1	7.675E-1
N° 4 (ON)	---	1.785E-1	3.311E-1	7.370E-1	7.230E+0
N° 5 (ON)	---	5.036E-2	1.740E-1	4.578E-1	7.950E-1
N° 6 (ON)	---	4.119E-2	1.587E-1	4.364E-1	7.645E-1
N° 7 (OFF)	---	6.714E-2	8.392E-2	1.099E-1	1.312E-1
N° 8 (OFF)	---	1.084E-1	1.023E-1	1.267E-1	1.435E-1
N° 9 (OFF)	---	3.357E-2	2.900E-2	3.205E-2	2.594E-2
N° 10 (OFF)	---	6.409E-2	5.646E-2	5.798E-2	5.951E-2
N° 11 (OFF)	---	3.357E-2	2.136E-2	3.510E-2	4.120E-2
Average (ON)	---	7.294E-2	1.971E-1	5.090E-1	2.072E+0
s (ON)	---	6.223E-2	7.546E-2	1.282E-1	2.884E+0
Average+3s (ON)	---	2.596E-1	4.235E-1	8.937E-1	1.072E+1
Average-3s (ON)	---	-1.138E-1	-2.924E-2	1.243E-1	-6.579E+0
Average (OFF)	---	6.135E-2	5.861E-2	7.234E-2	8.028E-2
s (OFF)	---	3.081E-2	3.471E-2	4.353E-2	5.363E-2
Average+3s (OFF)	---	1.538E-1	1.627E-1	2.029E-1	2.412E-1
Average-3s (OFF)	---	-3.109E-2	-4.551E-2	-5.825E-2	-8.061E-2

82. Isb_L

Ta = 25°C, Vcc = 3.3V, Vih = 2.0V, Vil = 0.8V, #CS = Vih, Other inputs = Vil

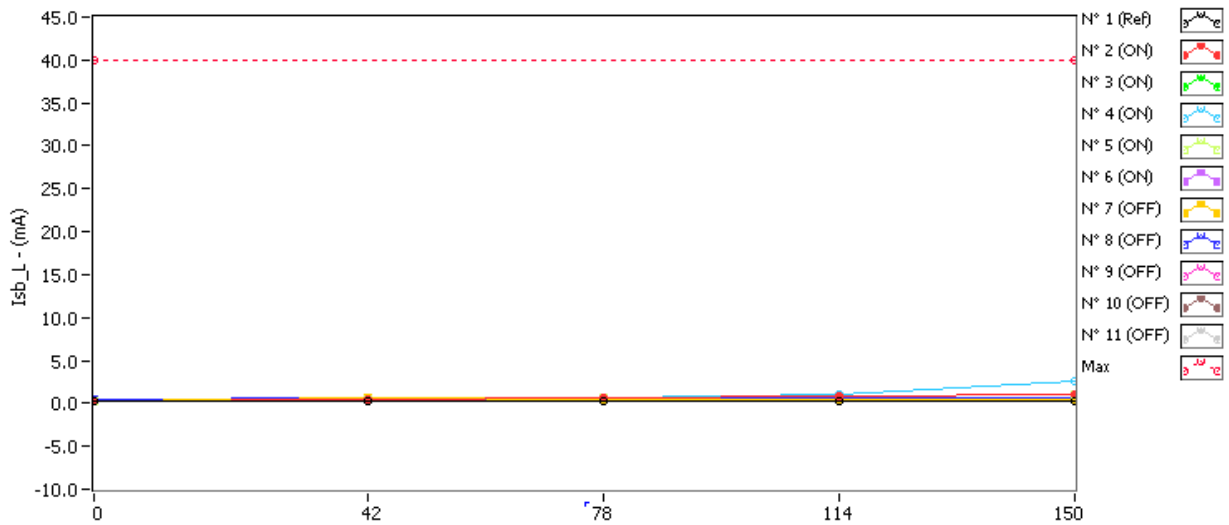

Isb_L . (mA) Max = 40.0

	0krad(Si)	42krad(Si)	78krad(Si)	114krad(Si)	150krad(Si)
N° 1 (Ref)	0.253	0.250	0.258	0.258	0.250
N° 2 (ON)	0.272	0.365	0.584	0.841	1.085
N° 3 (ON)	0.357	0.461	0.676	0.899	1.131
N° 4 (ON)	0.354	0.481	0.713	0.980	2.501
N° 5 (ON)	0.272	0.366	0.581	0.845	1.093
N° 6 (ON)	0.304	0.397	0.620	0.867	1.117
N° 7 (OFF)	0.339	0.684	0.449	0.476	0.494
N° 8 (OFF)	0.531	0.610	0.647	0.679	0.697
N° 9 (OFF)	0.266	0.319	0.351	0.369	0.383
N° 10 (OFF)	0.308	0.366	0.400	0.423	0.438
N° 11 (OFF)	0.317	0.374	0.409	0.433	0.450

Delta [Isb_L]

	0krad(Si)	42krad(Si)	78krad(Si)	114krad(Si)	150krad(Si)
N° 1 (Ref)	---	-3.060E-3	4.570E-3	4.570E-3	-3.060E-3
N° 2 (ON)	---	9.308E-2	3.128E-1	5.691E-1	8.133E-1
N° 3 (ON)	---	1.038E-1	3.189E-1	5.417E-1	7.736E-1
N° 4 (ON)	---	1.267E-1	3.586E-1	6.256E-1	2.147E+0
N° 5 (ON)	---	9.460E-2	3.097E-1	5.737E-1	8.209E-1
N° 6 (ON)	---	9.308E-2	3.159E-1	5.631E-1	8.133E-1
N° 7 (OFF)	---	3.448E-1	1.099E-1	1.373E-1	1.556E-1
N° 8 (OFF)	---	7.934E-2	1.160E-1	1.480E-1	1.663E-1
N° 9 (OFF)	---	5.341E-2	8.545E-2	1.038E-1	1.175E-1
N° 10 (OFF)	---	5.798E-2	9.155E-2	1.144E-1	1.297E-1
N° 11 (OFF)	---	5.646E-2	9.156E-2	1.160E-1	1.327E-1
Average (ON)	---	1.022E-1	3.232E-1	5.746E-1	1.074E+0
s (ON)	---	1.436E-2	2.009E-2	3.102E-2	6.003E-1
Average+3s (ON)	---	1.453E-1	3.834E-1	6.677E-1	2.874E+0
Average-3s (ON)	---	5.917E-2	2.629E-1	4.816E-1	-7.273E-1
Average (OFF)	---	1.184E-1	9.888E-2	1.239E-1	1.404E-1
s (OFF)	---	1.270E-1	1.323E-2	1.816E-2	2.001E-2
Average+3s (OFF)	---	4.994E-1	1.386E-1	1.784E-1	2.004E-1
Average-3s (OFF)	---	-2.626E-1	5.919E-2	6.941E-2	8.036E-2

83. Isb1_H

Ta = 25°C, Vcc = 3.3V, Vih = 2.0V, Vil = 0.8V, #CS = Vcc, Other inputs = Vcc

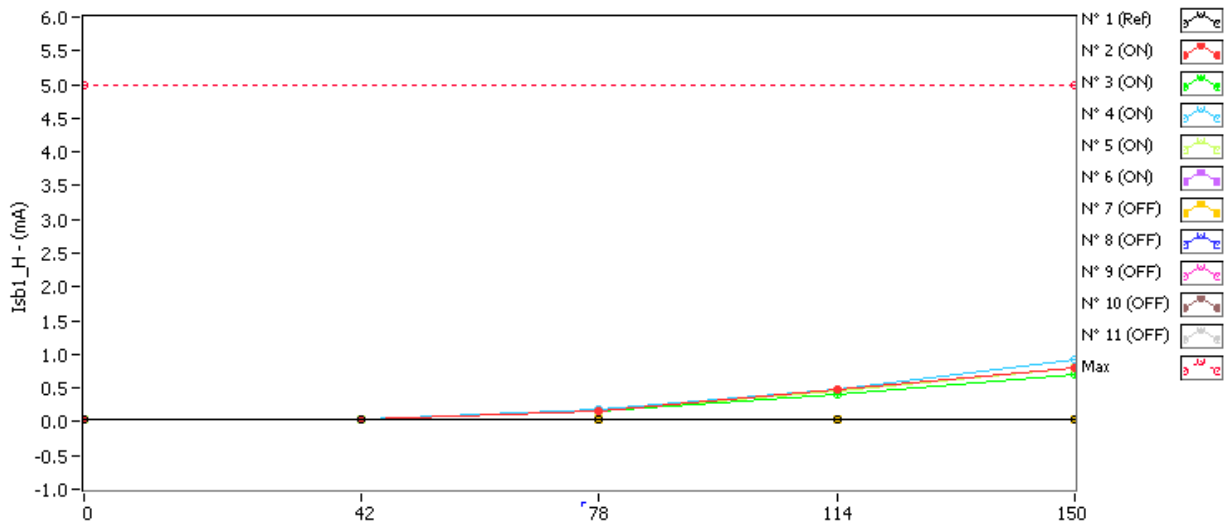

Isb1_H . (mA) Max = 5.0

	0krad(Si)	42krad(Si)	78krad(Si)	114krad(Si)	150krad(Si)
N° 1 (Ref)	0.037	0.037	0.035	0.035	0.035
N° 2 (ON)	0.037	0.040	0.169	0.479	0.810
N° 3 (ON)	0.037	0.040	0.156	0.417	0.702
N° 4 (ON)	0.037	0.041	0.183	0.482	0.922
N° 5 (ON)	0.037	0.040	0.159	0.447	0.789
N° 6 (ON)	0.037	0.040	0.162	0.456	0.800
N° 7 (OFF)	0.038	0.040	0.040	0.038	0.040
N° 8 (OFF)	0.041	0.041	0.041	0.041	0.043
N° 9 (OFF)	0.037	0.037	0.038	0.038	0.038
N° 10 (OFF)	0.040	0.040	0.038	0.040	0.040
N° 11 (OFF)	0.035	0.037	0.037	0.037	0.038

Delta [Isb1_H]

	0krad(Si)	42krad(Si)	78krad(Si)	114krad(Si)	150krad(Si)
N° 1 (Ref)	---	0.000E+0	-1.526E-3	-1.526E-3	-1.526E-3
N° 2 (ON)	---	3.052E-3	1.327E-1	4.425E-1	7.736E-1
N° 3 (ON)	---	3.052E-3	1.190E-1	3.799E-1	6.653E-1
N° 4 (ON)	---	4.578E-3	1.465E-1	4.456E-1	8.850E-1
N° 5 (ON)	---	3.052E-3	1.221E-1	4.105E-1	7.523E-1
N° 6 (ON)	---	3.052E-3	1.251E-1	4.196E-1	7.629E-1
N° 7 (OFF)	---	1.526E-3	1.526E-3	0.000E+0	1.526E-3
N° 8 (OFF)	---	0.000E+0	0.000E+0	0.000E+0	1.526E-3
N° 9 (OFF)	---	0.000E+0	1.526E-3	1.526E-3	1.526E-3
N° 10 (OFF)	---	0.000E+0	-1.526E-3	0.000E+0	0.000E+0
N° 11 (OFF)	---	1.526E-3	1.526E-3	1.526E-3	3.052E-3
Average (ON)	---	3.357E-3	1.291E-1	4.196E-1	7.678E-1
s (ON)	---	6.824E-4	1.098E-2	2.672E-2	7.834E-2
Average+3s (ON)	---	5.405E-3	1.620E-1	4.998E-1	1.003E+0
Average-3s (ON)	---	1.310E-3	9.614E-2	3.395E-1	5.328E-1
Average (OFF)	---	6.104E-4	6.104E-4	6.104E-4	1.526E-3
s (OFF)	---	8.358E-4	1.365E-3	8.358E-4	1.079E-3
Average+3s (OFF)	---	3.118E-3	4.705E-3	3.118E-3	4.763E-3
Average-3s (OFF)	---	-1.897E-3	-3.484E-3	-1.897E-3	-1.711E-3

84. Isb1_L

Ta = 25°C, Vcc = 3.3V, Vih = 2.0V, Vil = 0.8V, #CS = Vcc, Other inputs = 0V

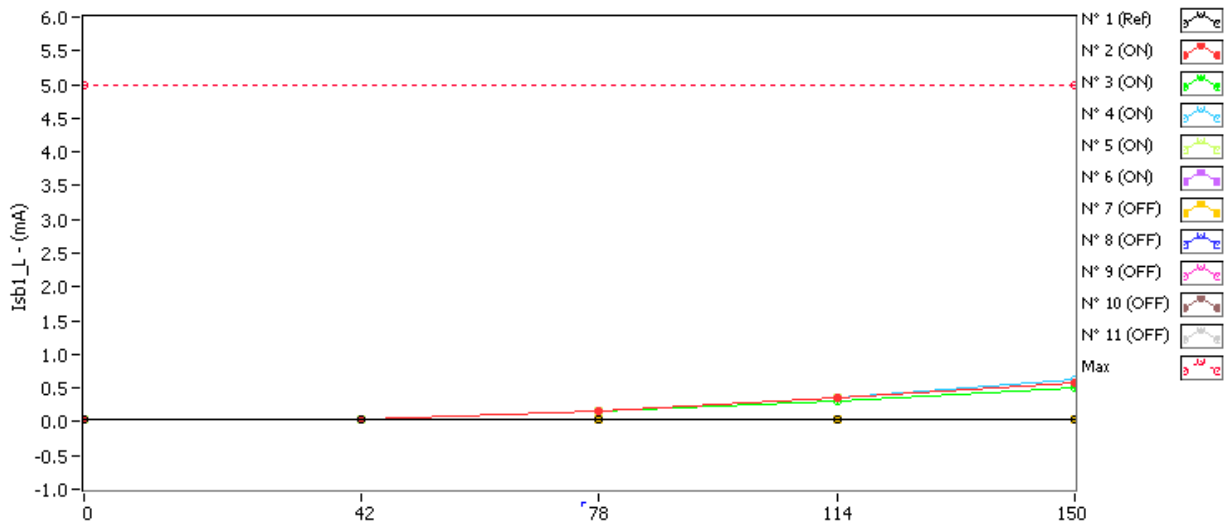

Isb1_L . (mA) Max = 5.0

	0krad(Si)	42krad(Si)	78krad(Si)	114krad(Si)	150krad(Si)
N° 1 (Ref)	0.037	0.035	0.035	0.037	0.035
N° 2 (ON)	0.038	0.041	0.154	0.352	0.566
N° 3 (ON)	0.037	0.040	0.146	0.314	0.507
N° 4 (ON)	0.037	0.043	0.166	0.360	0.636
N° 5 (ON)	0.037	0.040	0.148	0.352	0.574
N° 6 (ON)	0.037	0.040	0.151	0.346	0.568
N° 7 (OFF)	0.038	0.040	0.040	0.040	0.041
N° 8 (OFF)	0.041	0.041	0.041	0.041	0.043
N° 9 (OFF)	0.037	0.037	0.037	0.037	0.040
N° 10 (OFF)	0.040	0.040	0.040	0.040	0.040
N° 11 (OFF)	0.037	0.037	0.035	0.037	0.038

Delta [Isb1_L]

	0krad(Si)	42krad(Si)	78krad(Si)	114krad(Si)	150krad(Si)
N° 1 (Ref)	---	-1.526E-3	-1.526E-3	0.000E+0	-1.526E-3
N° 2 (ON)	---	3.052E-3	1.160E-1	3.143E-1	5.280E-1
N° 3 (ON)	---	3.052E-3	1.099E-1	2.777E-1	4.700E-1
N° 4 (ON)	---	6.104E-3	1.297E-1	3.235E-1	5.997E-1
N° 5 (ON)	---	3.052E-3	1.114E-1	3.159E-1	5.371E-1
N° 6 (ON)	---	3.052E-3	1.144E-1	3.097E-1	5.310E-1
N° 7 (OFF)	---	1.526E-3	1.526E-3	1.526E-3	3.052E-3
N° 8 (OFF)	---	0.000E+0	0.000E+0	0.000E+0	1.526E-3
N° 9 (OFF)	---	0.000E+0	0.000E+0	0.000E+0	3.052E-3
N° 10 (OFF)	---	0.000E+0	0.000E+0	0.000E+0	0.000E+0
N° 11 (OFF)	---	0.000E+0	-1.526E-3	0.000E+0	1.526E-3
Average (ON)	---	3.662E-3	1.163E-1	3.082E-1	5.331E-1
s (ON)	---	1.365E-3	7.885E-3	1.776E-2	4.600E-2
Average+3s (ON)	---	7.757E-3	1.399E-1	3.615E-1	6.711E-1
Average-3s (ON)	---	-4.323E-4	9.261E-2	2.549E-1	3.951E-1
Average (OFF)	---	3.052E-4	0.000E+0	3.052E-4	1.831E-3
s (OFF)	---	6.824E-4	1.079E-3	6.824E-4	1.277E-3
Average+3s (OFF)	---	2.353E-3	3.237E-3	2.353E-3	5.661E-3
Average-3s (OFF)	---	-1.742E-3	-3.237E-3	-1.742E-3	-1.999E-3

85. Vol_IO[0]

Ta = 25°C, Vcc = 3.3V, Iol = 8mA

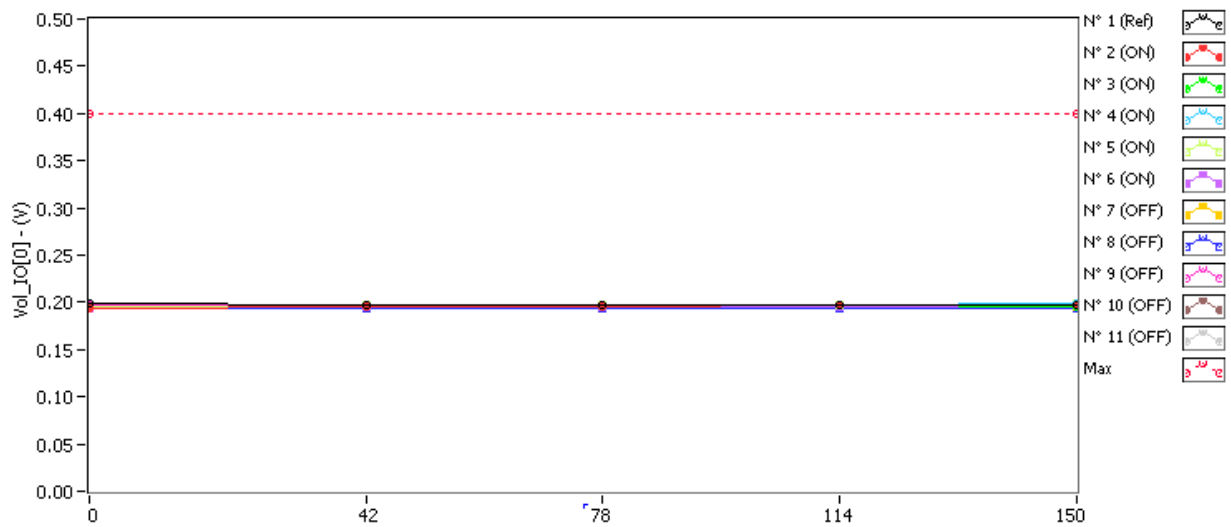

Vol_IO[0] . (V) Max = 0.4

	0krad(Si)	42krad(Si)	78krad(Si)	114krad(Si)	150krad(Si)
N° 1 (Ref)	0.200	0.198	0.198	0.197	0.197
N° 2 (ON)	0.194	0.196	0.196	0.197	0.198
N° 3 (ON)	0.194	0.196	0.195	0.196	0.196
N° 4 (ON)	0.194	0.196	0.196	0.197	0.198
N° 5 (ON)	0.195	0.197	0.197	0.197	0.198
N° 6 (ON)	0.194	0.195	0.195	0.196	0.197
N° 7 (OFF)	0.194	0.196	0.196	0.195	0.195
N° 8 (OFF)	0.194	0.194	0.193	0.194	0.194
N° 9 (OFF)	0.196	0.197	0.197	0.197	0.197
N° 10 (OFF)	0.197	0.197	0.196	0.197	0.197
N° 11 (OFF)	0.195	0.195	0.195	0.195	0.196

Delta [Vol_IO[0]]

	0krad(Si)	42krad(Si)	78krad(Si)	114krad(Si)	150krad(Si)
N° 1 (Ref)	---	-1.980E-3	-1.830E-3	-2.590E-3	-3.050E-3
N° 2 (ON)	---	1.370E-3	1.370E-3	2.750E-3	3.510E-3
N° 3 (ON)	---	2.130E-3	1.520E-3	2.900E-3	2.740E-3
N° 4 (ON)	---	1.370E-3	2.140E-3	2.900E-3	3.970E-3
N° 5 (ON)	---	1.680E-3	1.680E-3	2.130E-3	2.740E-3
N° 6 (ON)	---	1.220E-3	1.220E-3	2.130E-3	3.050E-3
N° 7 (OFF)	---	1.830E-3	1.220E-3	4.600E-4	9.200E-4
N° 8 (OFF)	---	0.000E+0	-6.100E-4	-1.500E-4	-3.000E-4
N° 9 (OFF)	---	6.100E-4	4.500E-4	4.500E-4	6.100E-4
N° 10 (OFF)	---	0.000E+0	-6.100E-4	4.600E-4	6.100E-4
N° 11 (OFF)	---	-1.500E-4	0.000E+0	3.100E-4	6.100E-4
Average (ON)	---	1.554E-3	1.586E-3	2.562E-3	3.202E-3
s (ON)	---	3.629E-4	3.538E-4	3.991E-4	5.326E-4
Average+3s (ON)	---	2.643E-3	2.647E-3	3.759E-3	4.800E-3
Average-3s (ON)	---	4.652E-4	5.246E-4	1.365E-3	1.604E-3
Average (OFF)	---	4.580E-4	9.000E-5	3.060E-4	4.900E-4
s (OFF)	---	8.208E-4	7.737E-4	2.627E-4	4.616E-4
Average+3s (OFF)	---	2.920E-3	2.411E-3	1.094E-3	1.875E-3
Average-3s (OFF)	---	-2.004E-3	-2.231E-3	-4.822E-4	-8.947E-4

86. Vol_IO[1]

Ta = 25°C, Vcc = 3.3V, Iol = 8mA

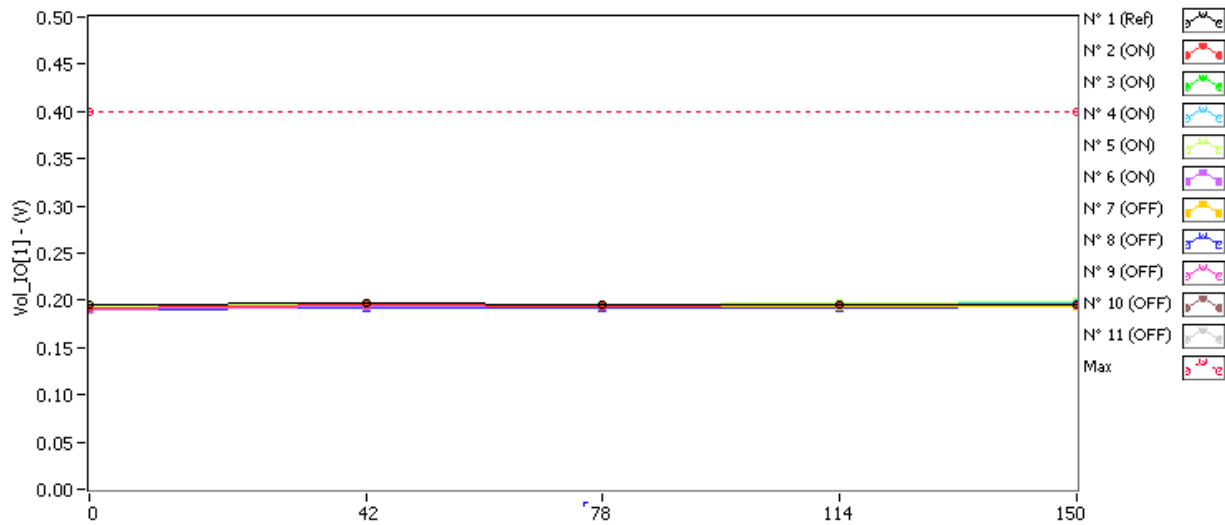

Vol_IO[1] . (V) Max = 0.4

	0krad(Si)	42krad(Si)	78krad(Si)	114krad(Si)	150krad(Si)
N° 1 (Ref)	0.196	0.196	0.196	0.196	0.196
N° 2 (ON)	0.192	0.195	0.194	0.195	0.196
N° 3 (ON)	0.192	0.195	0.194	0.195	0.196
N° 4 (ON)	0.192	0.195	0.195	0.195	0.197
N° 5 (ON)	0.194	0.197	0.196	0.197	0.198
N° 6 (ON)	0.191	0.194	0.194	0.195	0.195
N° 7 (OFF)	0.192	0.194	0.193	0.194	0.194
N° 8 (OFF)	0.190	0.192	0.191	0.192	0.193
N° 9 (OFF)	0.194	0.196	0.195	0.196	0.196
N° 10 (OFF)	0.193	0.196	0.195	0.195	0.195
N° 11 (OFF)	0.192	0.194	0.194	0.194	0.194

Delta [Vol_IO[1]]

	0krad(Si)	42krad(Si)	78krad(Si)	114krad(Si)	150krad(Si)
N° 1 (Ref)	---	4.600E-4	-1.600E-4	0.000E+0	-4.600E-4
N° 2 (ON)	---	2.590E-3	1.220E-3	2.130E-3	3.510E-3
N° 3 (ON)	---	2.900E-3	2.290E-3	3.360E-3	4.120E-3
N° 4 (ON)	---	2.590E-3	2.590E-3	2.890E-3	4.270E-3
N° 5 (ON)	---	2.900E-3	2.590E-3	3.200E-3	4.420E-3
N° 6 (ON)	---	3.200E-3	3.050E-3	4.120E-3	4.730E-3
N° 7 (OFF)	---	2.280E-3	1.370E-3	1.830E-3	2.280E-3
N° 8 (OFF)	---	2.290E-3	1.530E-3	2.450E-3	3.060E-3
N° 9 (OFF)	---	1.980E-3	1.680E-3	1.830E-3	2.440E-3
N° 10 (OFF)	---	2.590E-3	1.980E-3	2.440E-3	1.980E-3
N° 11 (OFF)	---	2.290E-3	2.140E-3	1.680E-3	2.290E-3
Average (ON)	---	2.836E-3	2.348E-3	3.140E-3	4.210E-3
s (ON)	---	2.558E-4	6.866E-4	7.237E-4	4.517E-4
Average+3s (ON)	---	3.603E-3	4.408E-3	5.311E-3	5.565E-3
Average-3s (ON)	---	2.069E-3	2.882E-4	9.689E-4	2.855E-3
Average (OFF)	---	2.286E-3	1.740E-3	2.046E-3	2.410E-3
s (OFF)	---	2.157E-4	3.171E-4	3.694E-4	3.999E-4
Average+3s (OFF)	---	2.933E-3	2.691E-3	3.154E-3	3.610E-3
Average-3s (OFF)	---	1.639E-3	7.887E-4	9.379E-4	1.210E-3

87. Vol_IO[2]

Ta = 25°C, Vcc = 3.3V, Iol = 8mA

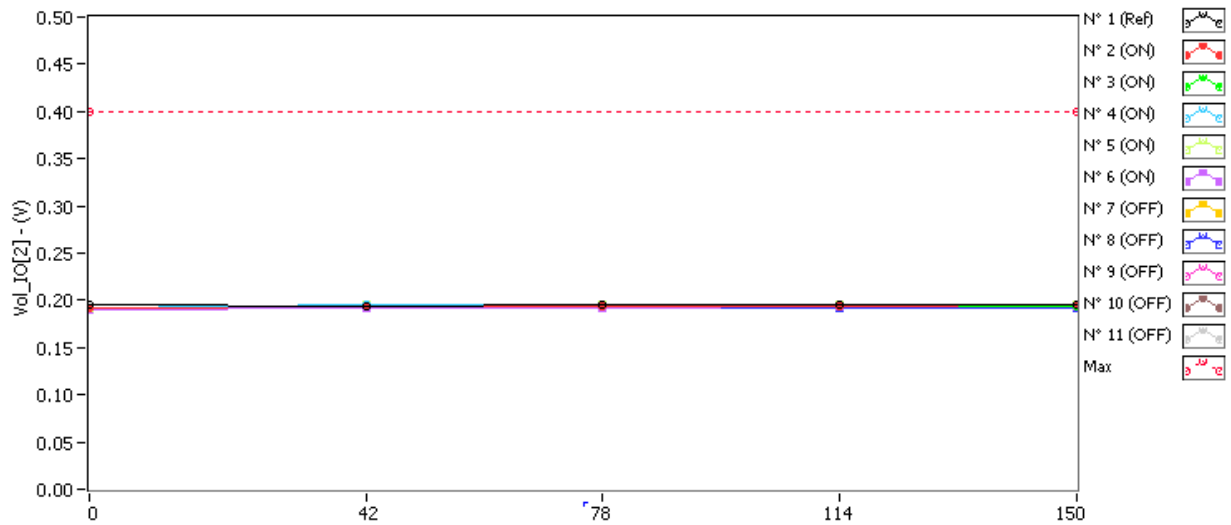

Vol_IO[2] . (V) Max = 0.4

	0krad(Si)	42krad(Si)	78krad(Si)	114krad(Si)	150krad(Si)
N° 1 (Ref)	0.195	0.194	0.195	0.195	0.195
N° 2 (ON)	0.192	0.194	0.194	0.194	0.195
N° 3 (ON)	0.192	0.194	0.194	0.194	0.194
N° 4 (ON)	0.192	0.195	0.194	0.195	0.195
N° 5 (ON)	0.193	0.195	0.195	0.195	0.196
N° 6 (ON)	0.190	0.193	0.192	0.193	0.194
N° 7 (OFF)	0.192	0.194	0.193	0.195	0.194
N° 8 (OFF)	0.190	0.192	0.192	0.192	0.193
N° 9 (OFF)	0.193	0.196	0.194	0.194	0.196
N° 10 (OFF)	0.191	0.193	0.193	0.194	0.193
N° 11 (OFF)	0.192	0.194	0.194	0.194	0.194

Delta [Vol_IO[2]]

	0krad(Si)	42krad(Si)	78krad(Si)	114krad(Si)	150krad(Si)
N° 1 (Ref)	---	-4.600E-4	1.500E-4	-1.500E-4	-3.100E-4
N° 2 (ON)	---	2.440E-3	1.830E-3	2.590E-3	2.900E-3
N° 3 (ON)	---	2.290E-3	1.830E-3	2.140E-3	2.290E-3
N° 4 (ON)	---	3.050E-3	2.280E-3	2.890E-3	3.500E-3
N° 5 (ON)	---	2.290E-3	2.290E-3	2.600E-3	3.050E-3
N° 6 (ON)	---	2.590E-3	1.980E-3	2.900E-3	3.510E-3
N° 7 (OFF)	---	2.750E-3	1.830E-3	3.210E-3	2.440E-3
N° 8 (OFF)	---	2.140E-3	1.990E-3	1.380E-3	2.290E-3
N° 9 (OFF)	---	3.050E-3	1.830E-3	1.830E-3	2.900E-3
N° 10 (OFF)	---	1.980E-3	1.830E-3	2.290E-3	1.980E-3
N° 11 (OFF)	---	2.280E-3	2.130E-3	2.130E-3	2.130E-3
Average (ON)	---	2.532E-3	2.042E-3	2.624E-3	3.050E-3
s (ON)	---	3.152E-4	2.302E-4	3.094E-4	5.035E-4
Average+3s (ON)	---	3.477E-3	2.732E-3	3.552E-3	4.561E-3
Average-3s (ON)	---	1.587E-3	1.352E-3	1.696E-3	1.539E-3
Average (OFF)	---	2.440E-3	1.922E-3	2.168E-3	2.348E-3
s (OFF)	---	4.459E-4	1.354E-4	6.777E-4	3.534E-4
Average+3s (OFF)	---	3.778E-3	2.328E-3	4.201E-3	3.408E-3
Average-3s (OFF)	---	1.102E-3	1.516E-3	1.348E-4	1.288E-3

88. Vol_IO[3]

Ta = 25°C, Vcc = 3.3V, Iol = 8mA

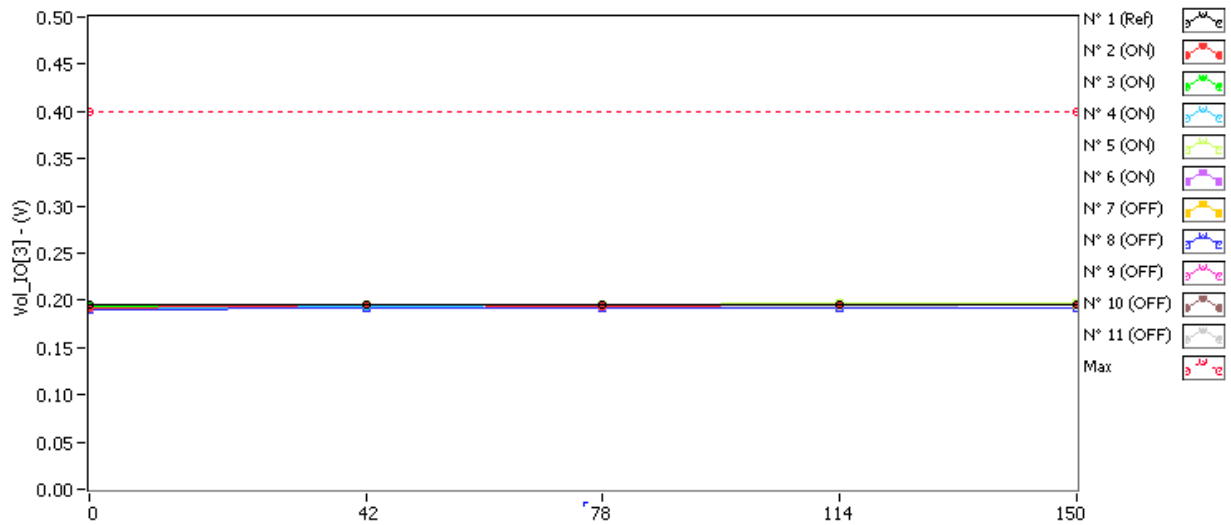

Vol_IO[3] . (V) Max = 0.4

	0krad(Si)	42krad(Si)	78krad(Si)	114krad(Si)	150krad(Si)
N° 1 (Ref)	0.196	0.196	0.195	0.196	0.195
N° 2 (ON)	0.192	0.195	0.193	0.196	0.196
N° 3 (ON)	0.193	0.195	0.194	0.195	0.196
N° 4 (ON)	0.193	0.194	0.195	0.195	0.196
N° 5 (ON)	0.193	0.196	0.196	0.197	0.197
N° 6 (ON)	0.192	0.195	0.194	0.196	0.197
N° 7 (OFF)	0.193	0.195	0.194	0.195	0.196
N° 8 (OFF)	0.190	0.193	0.192	0.192	0.192
N° 9 (OFF)	0.192	0.196	0.194	0.195	0.195
N° 10 (OFF)	0.192	0.196	0.195	0.195	0.196
N° 11 (OFF)	0.192	0.195	0.194	0.194	0.195

Delta [Vol_IO[3]]

	0krad(Si)	42krad(Si)	78krad(Si)	114krad(Si)	150krad(Si)
N° 1 (Ref)	---	6.100E-4	-1.500E-4	3.000E-4	-1.500E-4
N° 2 (ON)	---	2.280E-3	7.600E-4	3.200E-3	3.200E-3
N° 3 (ON)	---	1.980E-3	1.370E-3	1.830E-3	3.050E-3
N° 4 (ON)	---	1.830E-3	1.980E-3	2.590E-3	3.200E-3
N° 5 (ON)	---	3.200E-3	2.590E-3	3.660E-3	4.420E-3
N° 6 (ON)	---	2.600E-3	1.830E-3	3.510E-3	4.430E-3
N° 7 (OFF)	---	2.600E-3	1.380E-3	1.990E-3	3.360E-3
N° 8 (OFF)	---	2.740E-3	1.830E-3	1.980E-3	2.130E-3
N° 9 (OFF)	---	3.360E-3	2.290E-3	2.440E-3	2.750E-3
N° 10 (OFF)	---	3.510E-3	2.290E-3	2.290E-3	3.350E-3
N° 11 (OFF)	---	3.050E-3	1.520E-3	1.830E-3	2.890E-3
Average (ON)	---	2.378E-3	1.706E-3	2.958E-3	3.660E-3
s (ON)	---	5.462E-4	6.855E-4	7.523E-4	7.010E-4
Average+3s (ON)	---	4.017E-3	3.763E-3	5.215E-3	5.763E-3
Average-3s (ON)	---	7.394E-4	-3.505E-4	7.011E-4	1.557E-3
Average (OFF)	---	3.052E-3	1.862E-3	2.106E-3	2.896E-3
s (OFF)	---	3.893E-4	4.233E-4	2.505E-4	5.073E-4
Average+3s (OFF)	---	4.220E-3	3.132E-3	2.857E-3	4.418E-3
Average-3s (OFF)	---	1.884E-3	5.921E-4	1.355E-3	1.374E-3

89. Vol_IO[4]

Ta = 25°C, Vcc = 3.3V, Iol = 8mA

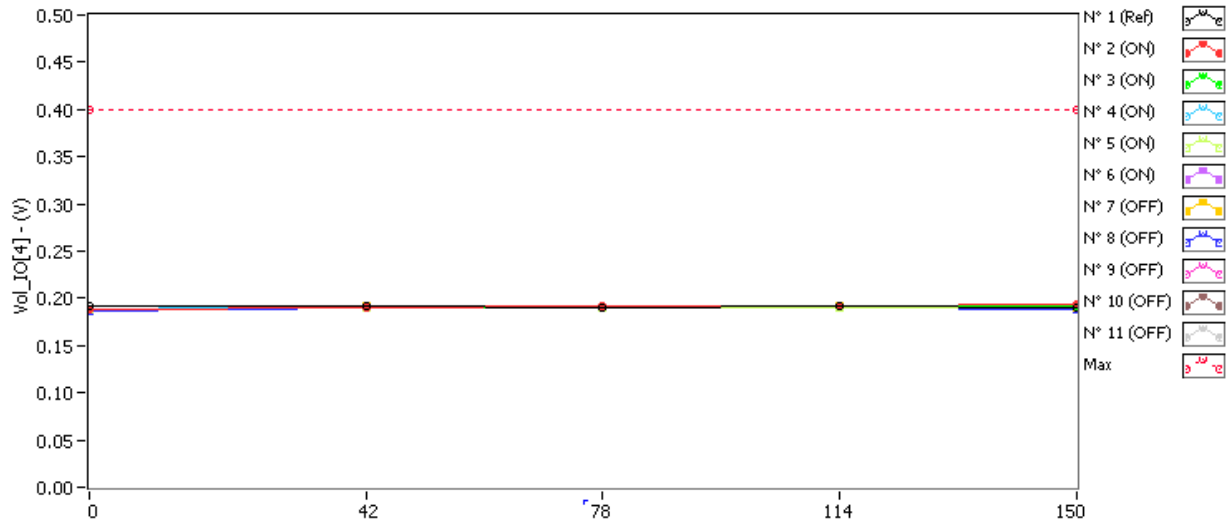

Vol_IO[4] . (V) Max = 0.4

	0krad(Si)	42krad(Si)	78krad(Si)	114krad(Si)	150krad(Si)
N° 1 (Ref)	0.191	0.192	0.191	0.192	0.190
N° 2 (ON)	0.189	0.190	0.192	0.192	0.193
N° 3 (ON)	0.188	0.190	0.191	0.192	0.191
N° 4 (ON)	0.189	0.191	0.191	0.192	0.193
N° 5 (ON)	0.189	0.190	0.190	0.191	0.192
N° 6 (ON)	0.188	0.190	0.190	0.190	0.192
N° 7 (OFF)	0.189	0.191	0.190	0.191	0.191
N° 8 (OFF)	0.187	0.189	0.189	0.189	0.189
N° 9 (OFF)	0.189	0.192	0.191	0.191	0.192
N° 10 (OFF)	0.188	0.191	0.191	0.190	0.190
N° 11 (OFF)	0.189	0.190	0.190	0.190	0.191

Delta [Vol_IO[4]]

	0krad(Si)	42krad(Si)	78krad(Si)	114krad(Si)	150krad(Si)
N° 1 (Ref)	---	6.200E-4	-1.500E-4	7.700E-4	-7.600E-4
N° 2 (ON)	---	1.070E-3	2.290E-3	2.450E-3	3.820E-3
N° 3 (ON)	---	1.520E-3	2.440E-3	3.200E-3	2.740E-3
N° 4 (ON)	---	2.590E-3	1.830E-3	3.200E-3	4.270E-3
N° 5 (ON)	---	1.220E-3	9.100E-4	1.980E-3	3.200E-3
N° 6 (ON)	---	2.590E-3	1.680E-3	2.440E-3	3.970E-3
N° 7 (OFF)	---	1.990E-3	1.070E-3	1.990E-3	1.530E-3
N° 8 (OFF)	---	2.290E-3	2.290E-3	2.290E-3	1.980E-3
N° 9 (OFF)	---	2.750E-3	1.680E-3	1.980E-3	2.750E-3
N° 10 (OFF)	---	2.290E-3	2.290E-3	1.830E-3	1.680E-3
N° 11 (OFF)	---	1.520E-3	1.520E-3	1.520E-3	2.130E-3
Average (ON)	---	1.798E-3	1.830E-3	2.654E-3	3.600E-3
s (ON)	---	7.409E-4	6.026E-4	5.334E-4	6.192E-4
Average+3s (ON)	---	4.021E-3	3.638E-3	4.254E-3	5.458E-3
Average-3s (ON)	---	-4.248E-4	2.214E-5	1.054E-3	1.742E-3
Average (OFF)	---	2.168E-3	1.770E-3	1.922E-3	2.014E-3
s (OFF)	---	4.528E-4	5.247E-4	2.799E-4	4.749E-4
Average+3s (OFF)	---	3.526E-3	3.344E-3	2.762E-3	3.439E-3
Average-3s (OFF)	---	8.096E-4	1.958E-4	1.082E-3	5.893E-4

90. Vol_IO[5]

Ta = 25°C, Vcc = 3.3V, Iol = 8mA

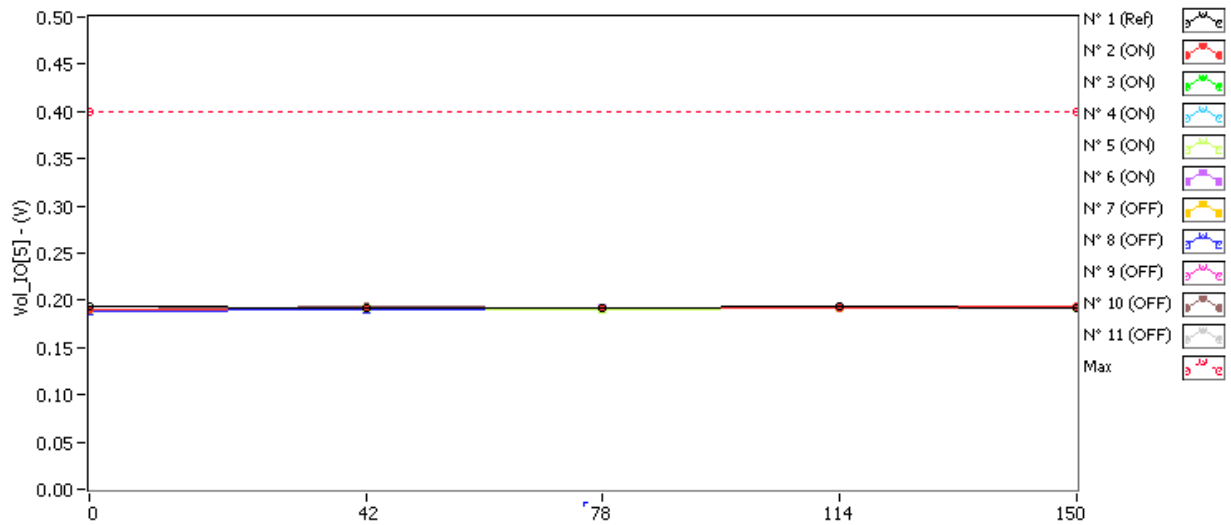

Vol_IO[5] . (V) Max = 0.4

	0krad(Si)	42krad(Si)	78krad(Si)	114krad(Si)	150krad(Si)
N° 1 (Ref)	0.193	0.192	0.192	0.193	0.192
N° 2 (ON)	0.190	0.193	0.192	0.192	0.194
N° 3 (ON)	0.190	0.192	0.192	0.192	0.192
N° 4 (ON)	0.190	0.192	0.192	0.193	0.193
N° 5 (ON)	0.189	0.191	0.191	0.192	0.192
N° 6 (ON)	0.190	0.193	0.191	0.193	0.193
N° 7 (OFF)	0.190	0.192	0.191	0.191	0.192
N° 8 (OFF)	0.188	0.191	0.189	0.191	0.191
N° 9 (OFF)	0.190	0.192	0.191	0.193	0.192
N° 10 (OFF)	0.191	0.193	0.192	0.192	0.192
N° 11 (OFF)	0.190	0.192	0.191	0.192	0.192

Delta [Vol_IO[5]]

	0krad(Si)	42krad(Si)	78krad(Si)	114krad(Si)	150krad(Si)
N° 1 (Ref)	---	-6.100E-4	-7.700E-4	1.500E-4	-7.700E-4
N° 2 (ON)	---	2.140E-3	1.530E-3	1.230E-3	3.360E-3
N° 3 (ON)	---	1.380E-3	1.380E-3	1.830E-3	1.990E-3
N° 4 (ON)	---	1.680E-3	1.990E-3	2.900E-3	3.510E-3
N° 5 (ON)	---	1.980E-3	1.220E-3	2.130E-3	2.130E-3
N° 6 (ON)	---	3.200E-3	1.520E-3	3.050E-3	3.200E-3
N° 7 (OFF)	---	1.830E-3	9.200E-4	1.370E-3	1.830E-3
N° 8 (OFF)	---	2.290E-3	9.200E-4	2.590E-3	2.590E-3
N° 9 (OFF)	---	2.290E-3	9.100E-4	2.440E-3	2.290E-3
N° 10 (OFF)	---	1.990E-3	1.380E-3	1.530E-3	1.220E-3
N° 11 (OFF)	---	1.370E-3	7.600E-4	1.530E-3	1.830E-3
Average (ON)	---	2.076E-3	1.528E-3	2.228E-3	2.838E-3
s (ON)	---	6.924E-4	2.873E-4	7.568E-4	7.203E-4
Average+3s (ON)	---	4.153E-3	2.390E-3	4.499E-3	4.999E-3
Average-3s (ON)	---	-1.335E-6	6.660E-4	-4.255E-5	6.770E-4
Average (OFF)	---	1.954E-3	9.780E-4	1.892E-3	1.952E-3
s (OFF)	---	3.819E-4	2.348E-4	5.749E-4	5.213E-4
Average+3s (OFF)	---	3.100E-3	1.682E-3	3.617E-3	3.516E-3
Average-3s (OFF)	---	8.082E-4	2.737E-4	1.673E-4	3.882E-4

91. Vol_IO[6]

Ta = 25°C, Vcc = 3.3V, Iol = 8mA

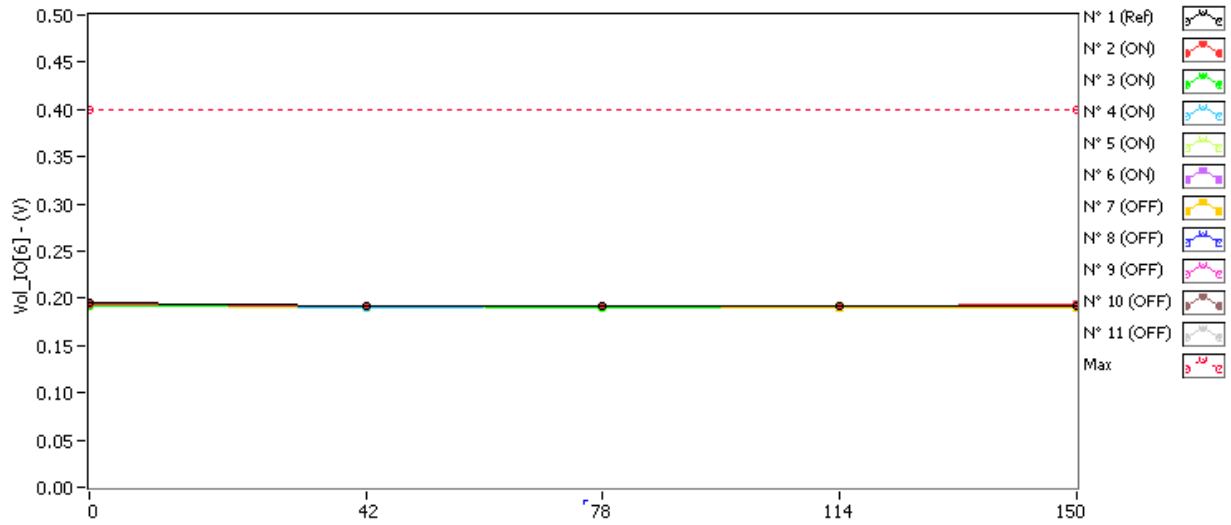

Vol_IO[6] . (V) Max = 0.4

	0krad(Si)	42krad(Si)	78krad(Si)	114krad(Si)	150krad(Si)
N° 1 (Ref)	0.195	0.192	0.192	0.192	0.192
N° 2 (ON)	0.194	0.193	0.192	0.192	0.194
N° 3 (ON)	0.192	0.191	0.190	0.191	0.192
N° 4 (ON)	0.193	0.191	0.191	0.192	0.193
N° 5 (ON)	0.192	0.190	0.190	0.192	0.192
N° 6 (ON)	0.192	0.191	0.191	0.192	0.193
N° 7 (OFF)	0.192	0.190	0.189	0.190	0.190
N° 8 (OFF)	0.192	0.190	0.190	0.190	0.190
N° 9 (OFF)	0.193	0.192	0.191	0.191	0.192
N° 10 (OFF)	0.192	0.190	0.190	0.192	0.191
N° 11 (OFF)	0.193	0.191	0.192	0.191	0.191

Delta [Vol_IO[6]]

	0krad(Si)	42krad(Si)	78krad(Si)	114krad(Si)	150krad(Si)
N° 1 (Ref)	---	-3.500E-3	-3.350E-3	-3.350E-3	-3.660E-3
N° 2 (ON)	---	-1.070E-3	-2.140E-3	-1.370E-3	0.000E+0
N° 3 (ON)	---	-1.230E-3	-1.990E-3	-9.200E-4	-7.700E-4
N° 4 (ON)	---	-2.740E-3	-2.290E-3	-1.220E-3	-3.000E-4
N° 5 (ON)	---	-1.990E-3	-2.290E-3	-7.600E-4	-6.100E-4
N° 6 (ON)	---	-1.520E-3	-1.220E-3	-1.500E-4	9.200E-4
N° 7 (OFF)	---	-1.680E-3	-2.590E-3	-2.290E-3	-1.830E-3
N° 8 (OFF)	---	-1.980E-3	-2.290E-3	-2.140E-3	-1.980E-3
N° 9 (OFF)	---	-1.830E-3	-2.740E-3	-2.740E-3	-1.830E-3
N° 10 (OFF)	---	-2.140E-3	-2.290E-3	-7.700E-4	-1.530E-3
N° 11 (OFF)	---	-1.370E-3	-9.100E-4	-1.980E-3	-1.220E-3
Average (ON)	---	-1.710E-3	-1.986E-3	-8.840E-4	-1.520E-4
s (ON)	---	6.737E-4	4.459E-4	4.755E-4	6.682E-4
Average+3s (ON)	---	3.111E-4	-6.483E-4	5.426E-4	1.853E-3
Average-3s (ON)	---	-3.731E-3	-3.324E-3	-2.311E-3	-2.157E-3
Average (OFF)	---	-1.800E-3	-2.164E-3	-1.984E-3	-1.678E-3
s (OFF)	---	2.950E-4	7.276E-4	7.354E-4	3.038E-4
Average+3s (OFF)	---	-9.149E-4	1.876E-5	2.222E-4	-7.667E-4
Average-3s (OFF)	---	-2.685E-3	-4.347E-3	-4.190E-3	-2.589E-3

92. Vol_IO[7]

Ta = 25°C, Vcc = 3.3V, Iol = 8mA

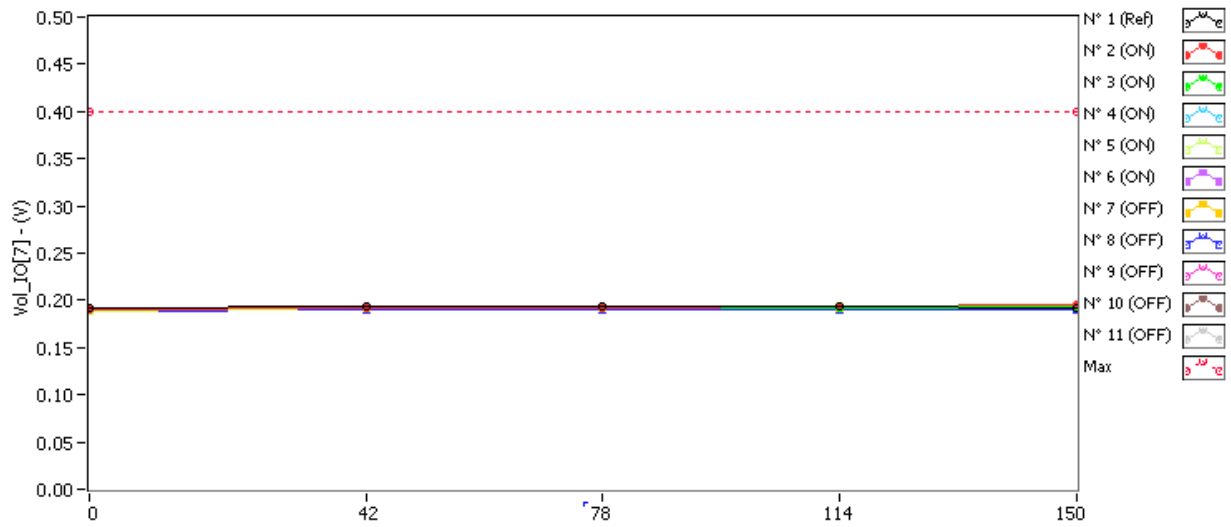

Vol_IO[7] . (V) Max = 0.4

	0krad(Si)	42krad(Si)	78krad(Si)	114krad(Si)	150krad(Si)
N° 1 (Ref)	0.192	0.193	0.193	0.193	0.192
N° 2 (ON)	0.191	0.192	0.193	0.193	0.195
N° 3 (ON)	0.190	0.192	0.193	0.193	0.194
N° 4 (ON)	0.190	0.192	0.192	0.193	0.194
N° 5 (ON)	0.189	0.192	0.192	0.194	0.194
N° 6 (ON)	0.190	0.192	0.192	0.194	0.194
N° 7 (OFF)	0.190	0.192	0.192	0.192	0.193
N° 8 (OFF)	0.188	0.191	0.191	0.190	0.191
N° 9 (OFF)	0.191	0.193	0.193	0.193	0.193
N° 10 (OFF)	0.190	0.192	0.192	0.193	0.193
N° 11 (OFF)	0.191	0.193	0.192	0.193	0.194

Delta [Vol_IO[7]]

	0krad(Si)	42krad(Si)	78krad(Si)	114krad(Si)	150krad(Si)
N° 1 (Ref)	---	9.200E-4	1.220E-3	1.070E-3	3.100E-4
N° 2 (ON)	---	1.220E-3	1.830E-3	2.290E-3	3.820E-3
N° 3 (ON)	---	2.750E-3	3.200E-3	3.200E-3	3.970E-3
N° 4 (ON)	---	1.980E-3	2.750E-3	3.660E-3	4.120E-3
N° 5 (ON)	---	2.900E-3	3.210E-3	4.280E-3	5.190E-3
N° 6 (ON)	---	2.590E-3	2.750E-3	3.970E-3	4.880E-3
N° 7 (OFF)	---	2.140E-3	2.140E-3	1.990E-3	3.060E-3
N° 8 (OFF)	---	2.440E-3	2.290E-3	1.680E-3	2.140E-3
N° 9 (OFF)	---	1.980E-3	1.680E-3	1.680E-3	1.980E-3
N° 10 (OFF)	---	2.750E-3	2.750E-3	3.360E-3	3.660E-3
N° 11 (OFF)	---	1.980E-3	1.220E-3	2.130E-3	3.050E-3
Average (ON)	---	2.288E-3	2.748E-3	3.480E-3	4.396E-3
s (ON)	---	6.919E-4	5.614E-4	7.757E-4	6.029E-4
Average+3s (ON)	---	4.364E-3	4.432E-3	5.807E-3	6.205E-3
Average-3s (ON)	---	2.124E-4	1.064E-3	1.153E-3	2.587E-3
Average (OFF)	---	2.258E-3	2.016E-3	2.168E-3	2.778E-3
s (OFF)	---	3.330E-4	5.865E-4	6.947E-4	7.027E-4
Average+3s (OFF)	---	3.257E-3	3.775E-3	4.252E-3	4.886E-3
Average-3s (OFF)	---	1.259E-3	2.566E-4	8.398E-5	6.698E-4

93. Vol_IO[8]

Ta = 25°C, Vcc = 3.3V, Iol = 8mA

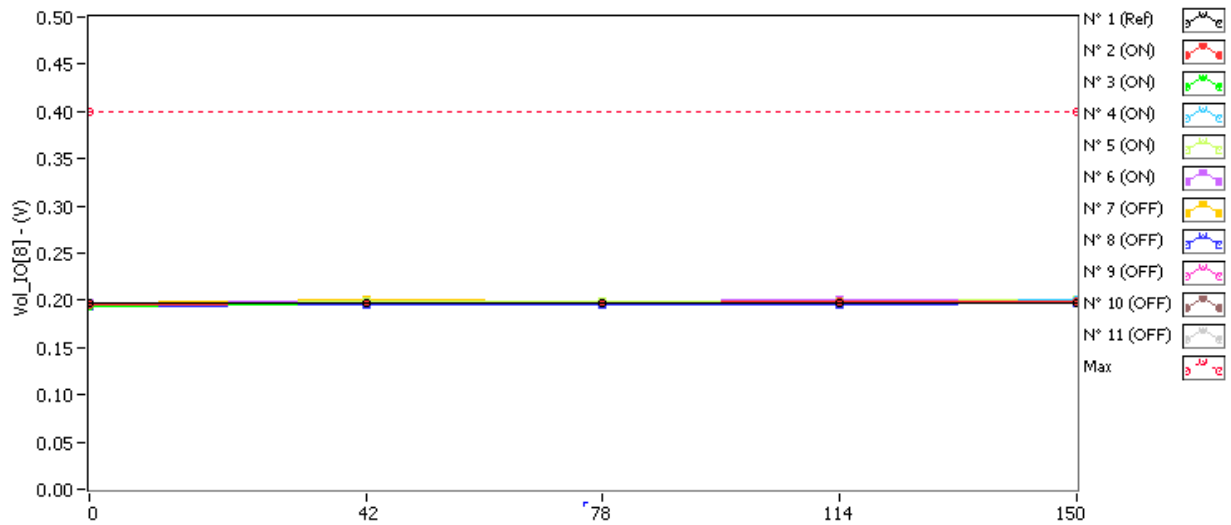

Vol_IO[8] . (V) Max = 0.4

	0krad(Si)	42krad(Si)	78krad(Si)	114krad(Si)	150krad(Si)
N° 1 (Ref)	0.198	0.198	0.198	0.198	0.198
N° 2 (ON)	0.196	0.198	0.197	0.198	0.199
N° 3 (ON)	0.194	0.197	0.197	0.198	0.198
N° 4 (ON)	0.196	0.197	0.197	0.197	0.200
N° 5 (ON)	0.196	0.198	0.199	0.199	0.201
N° 6 (ON)	0.197	0.200	0.199	0.201	0.201
N° 7 (OFF)	0.198	0.201	0.200	0.201	0.200
N° 8 (OFF)	0.194	0.196	0.196	0.195	0.197
N° 9 (OFF)	0.197	0.198	0.199	0.199	0.199
N° 10 (OFF)	0.196	0.198	0.198	0.197	0.198
N° 11 (OFF)	0.196	0.197	0.197	0.197	0.198

Delta [Vol_IO[8]]

	0krad(Si)	42krad(Si)	78krad(Si)	114krad(Si)	150krad(Si)
N° 1 (Ref)	---	0.000E+0	0.000E+0	0.000E+0	-1.500E-4
N° 2 (ON)	---	1.990E-3	1.230E-3	2.450E-3	3.210E-3
N° 3 (ON)	---	3.050E-3	2.590E-3	3.810E-3	3.970E-3
N° 4 (ON)	---	1.680E-3	1.680E-3	1.980E-3	4.580E-3
N° 5 (ON)	---	2.290E-3	2.750E-3	2.750E-3	4.430E-3
N° 6 (ON)	---	2.900E-3	2.440E-3	3.670E-3	4.430E-3
N° 7 (OFF)	---	2.600E-3	1.680E-3	2.600E-3	2.440E-3
N° 8 (OFF)	---	2.440E-3	1.680E-3	1.530E-3	2.900E-3
N° 9 (OFF)	---	1.680E-3	2.290E-3	1.830E-3	2.750E-3
N° 10 (OFF)	---	2.140E-3	2.440E-3	1.980E-3	2.290E-3
N° 11 (OFF)	---	1.530E-3	1.680E-3	1.680E-3	2.290E-3
Average (ON)	---	2.382E-3	2.138E-3	2.932E-3	4.124E-3
s (ON)	---	5.851E-4	6.527E-4	7.886E-4	5.600E-4
Average+3s (ON)	---	4.137E-3	4.096E-3	5.298E-3	5.804E-3
Average-3s (ON)	---	6.266E-4	1.798E-4	5.663E-4	2.444E-3
Average (OFF)	---	2.078E-3	1.954E-3	1.924E-3	2.534E-3
s (OFF)	---	4.653E-4	3.789E-4	4.134E-4	2.777E-4
Average+3s (OFF)	---	3.474E-3	3.091E-3	3.164E-3	3.367E-3
Average-3s (OFF)	---	6.820E-4	8.172E-4	6.837E-4	1.701E-3

94. Vol_IO[9]

Ta = 25°C, Vcc = 3.3V, Iol = 8mA

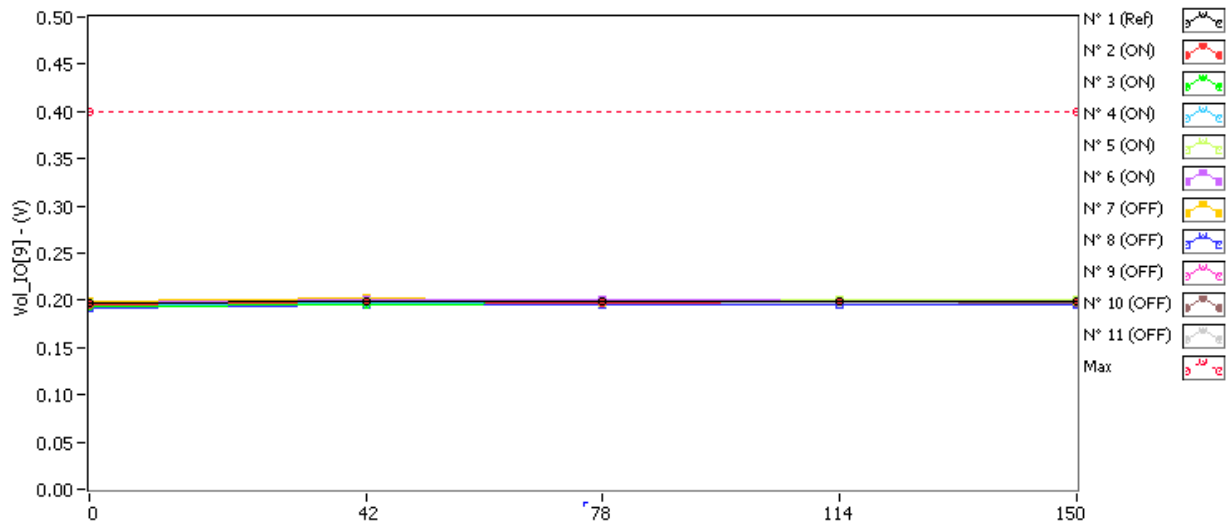

Vol_IO[9] . (V) Max = 0.4

	0krad(Si)	42krad(Si)	78krad(Si)	114krad(Si)	150krad(Si)
N° 1 (Ref)	0.196	0.199	0.199	0.199	0.199
N° 2 (ON)	0.196	0.199	0.197	0.199	0.199
N° 3 (ON)	0.194	0.195	0.198	0.199	0.198
N° 4 (ON)	0.196	0.197	0.197	0.198	0.199
N° 5 (ON)	0.197	0.199	0.198	0.200	0.201
N° 6 (ON)	0.197	0.200	0.200	0.201	0.201
N° 7 (OFF)	0.199	0.202	0.199	0.201	0.199
N° 8 (OFF)	0.192	0.196	0.195	0.195	0.196
N° 9 (OFF)	0.197	0.198	0.199	0.198	0.198
N° 10 (OFF)	0.196	0.197	0.199	0.198	0.197
N° 11 (OFF)	0.194	0.198	0.198	0.197	0.199

Delta [Vol_IO[9]]

	0krad(Si)	42krad(Si)	78krad(Si)	114krad(Si)	150krad(Si)
N° 1 (Ref)	---	2.740E-3	2.280E-3	2.890E-3	2.590E-3
N° 2 (ON)	---	3.360E-3	1.830E-3	3.820E-3	3.050E-3
N° 3 (ON)	---	1.680E-3	4.270E-3	4.880E-3	4.420E-3
N° 4 (ON)	---	1.830E-3	1.980E-3	2.750E-3	3.050E-3
N° 5 (ON)	---	1.990E-3	7.700E-4	3.360E-3	4.280E-3
N° 6 (ON)	---	2.890E-3	2.890E-3	4.270E-3	3.660E-3
N° 7 (OFF)	---	3.200E-3	1.500E-4	2.440E-3	3.000E-4
N° 8 (OFF)	---	3.510E-3	3.210E-3	3.050E-3	3.510E-3
N° 9 (OFF)	---	9.200E-4	1.990E-3	1.220E-3	1.220E-3
N° 10 (OFF)	---	6.100E-4	2.280E-3	1.830E-3	1.060E-3
N° 11 (OFF)	---	3.660E-3	3.660E-3	2.750E-3	4.580E-3
Average (ON)	---	2.350E-3	2.348E-3	3.816E-3	3.692E-3
s (ON)	---	7.349E-4	1.312E-3	8.189E-4	6.521E-4
Average+3s (ON)	---	4.555E-3	6.283E-3	6.273E-3	5.648E-3
Average-3s (ON)	---	1.452E-4	-1.587E-3	1.359E-3	1.736E-3
Average (OFF)	---	2.380E-3	2.258E-3	2.258E-3	2.134E-3
s (OFF)	---	1.488E-3	1.359E-3	7.354E-4	1.819E-3
Average+3s (OFF)	---	6.843E-3	6.335E-3	4.464E-3	7.590E-3
Average-3s (OFF)	---	-2.083E-3	-1.819E-3	5.189E-5	-3.322E-3

95. Vol_IO[10]

Ta = 25°C, Vcc = 3.3V, Iol = 8mA

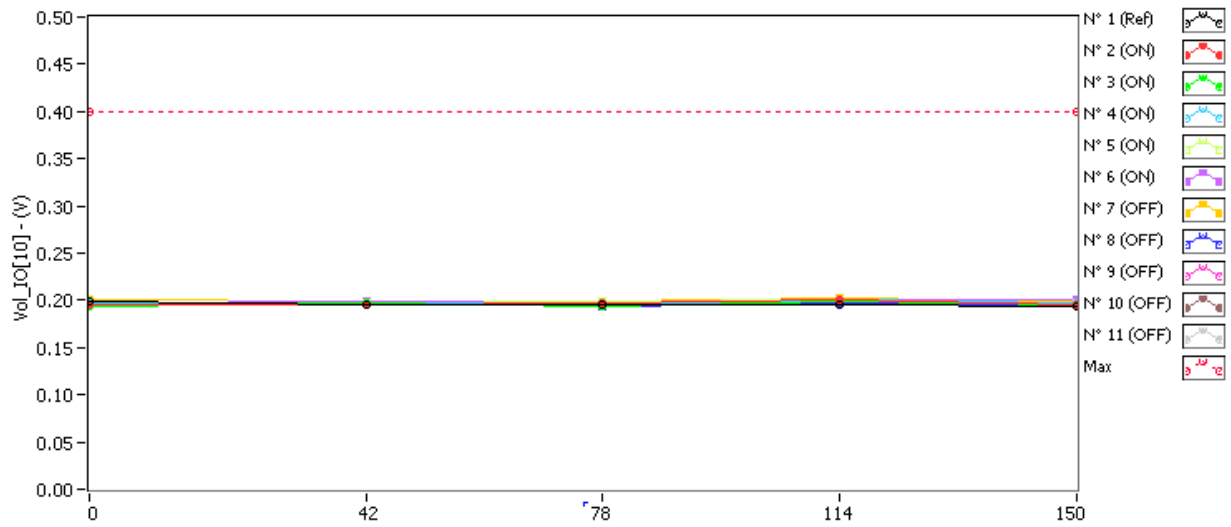

Vol_IO[10] . (V)

Max = 0.4

	0krad(Si)	42krad(Si)	78krad(Si)	114krad(Si)	150krad(Si)
N° 1 (Ref)	0.198	0.196	0.196	0.196	0.194
N° 2 (ON)	0.195	0.196	0.197	0.200	0.196
N° 3 (ON)	0.194	0.197	0.194	0.198	0.196
N° 4 (ON)	0.197	0.197	0.195	0.200	0.197
N° 5 (ON)	0.196	0.197	0.199	0.200	0.198
N° 6 (ON)	0.197	0.198	0.199	0.201	0.201
N° 7 (OFF)	0.201	0.199	0.198	0.202	0.198
N° 8 (OFF)	0.195	0.198	0.194	0.197	0.195
N° 9 (OFF)	0.197	0.198	0.199	0.201	0.197
N° 10 (OFF)	0.197	0.197	0.197	0.200	0.196
N° 11 (OFF)	0.198	0.196	0.196	0.199	0.195

Delta [Vol_IO[10]]

	0krad(Si)	42krad(Si)	78krad(Si)	114krad(Si)	150krad(Si)
N° 1 (Ref)	---	-2.140E-3	-2.750E-3	-2.750E-3	-3.970E-3
N° 2 (ON)	---	1.060E-3	2.590E-3	5.640E-3	1.370E-3
N° 3 (ON)	---	3.660E-3	6.100E-4	4.570E-3	1.980E-3
N° 4 (ON)	---	-1.600E-4	-2.140E-3	3.200E-3	-1.600E-4
N° 5 (ON)	---	7.700E-4	2.600E-3	3.970E-3	1.380E-3
N° 6 (ON)	---	1.530E-3	1.980E-3	3.820E-3	3.820E-3
N° 7 (OFF)	---	-1.380E-3	-2.290E-3	9.100E-4	-2.600E-3
N° 8 (OFF)	---	3.060E-3	-1.060E-3	1.680E-3	-6.100E-4
N° 9 (OFF)	---	1.220E-3	2.290E-3	3.810E-3	-6.100E-4
N° 10 (OFF)	---	-3.100E-4	-1.500E-4	2.740E-3	-9.200E-4
N° 11 (OFF)	---	-2.140E-3	-2.290E-3	1.060E-3	-3.060E-3
Average (ON)	---	1.372E-3	1.128E-3	4.240E-3	1.678E-3
s (ON)	---	1.420E-3	1.999E-3	9.219E-4	1.435E-3
Average+3s (ON)	---	5.632E-3	7.124E-3	7.006E-3	5.984E-3
Average-3s (ON)	---	-2.888E-3	-4.868E-3	1.474E-3	-2.628E-3
Average (OFF)	---	9.000E-5	-7.000E-4	2.040E-3	-1.560E-3
s (OFF)	---	2.085E-3	1.899E-3	1.224E-3	1.178E-3
Average+3s (OFF)	---	6.345E-3	4.998E-3	5.711E-3	1.973E-3
Average-3s (OFF)	---	-6.165E-3	-6.398E-3	-1.631E-3	-5.093E-3

96. Vol_IO[11]

Ta = 25°C, Vcc = 3.3V, Iol = 8mA

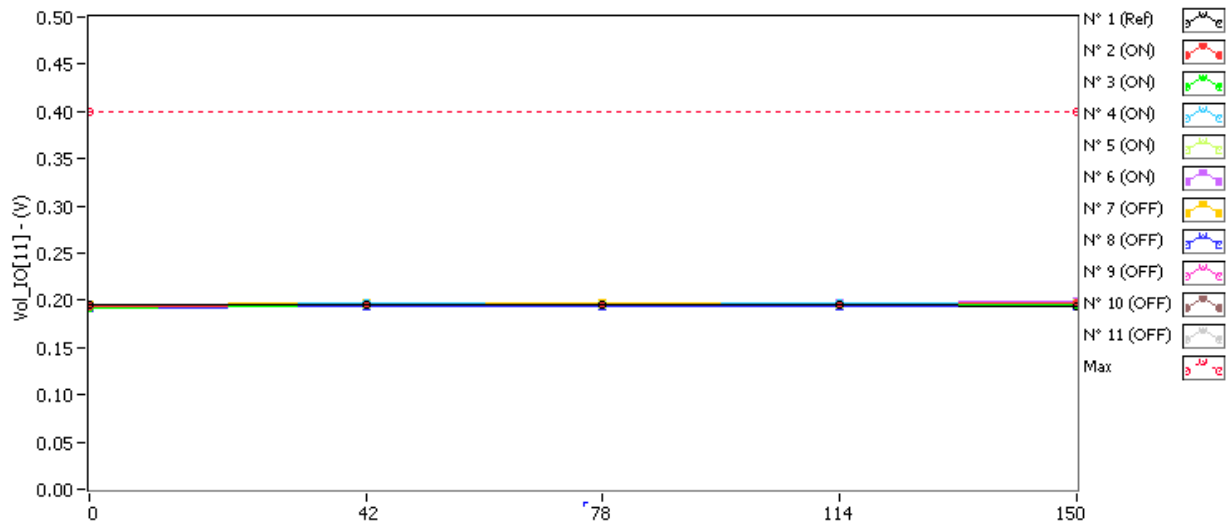

Vol_IO[11] . (V)

Max = 0.4

	0krad(Si)	42krad(Si)	78krad(Si)	114krad(Si)	150krad(Si)
N° 1 (Ref)	0.195	0.195	0.195	0.195	0.194
N° 2 (ON)	0.194	0.195	0.195	0.195	0.196
N° 3 (ON)	0.193	0.195	0.195	0.195	0.196
N° 4 (ON)	0.194	0.197	0.196	0.197	0.198
N° 5 (ON)	0.193	0.196	0.196	0.196	0.198
N° 6 (ON)	0.194	0.196	0.196	0.198	0.198
N° 7 (OFF)	0.195	0.198	0.198	0.197	0.197
N° 8 (OFF)	0.192	0.194	0.194	0.194	0.194
N° 9 (OFF)	0.195	0.196	0.197	0.196	0.197
N° 10 (OFF)	0.193	0.195	0.194	0.195	0.196
N° 11 (OFF)	0.193	0.195	0.195	0.194	0.195

Delta [Vol_IO[11]]

	0krad(Si)	42krad(Si)	78krad(Si)	114krad(Si)	150krad(Si)
N° 1 (Ref)	---	0.000E+0	0.000E+0	-3.100E-4	-1.070E-3
N° 2 (ON)	---	1.060E-3	1.060E-3	1.830E-3	2.900E-3
N° 3 (ON)	---	1.990E-3	1.990E-3	2.140E-3	3.210E-3
N° 4 (ON)	---	3.060E-3	1.990E-3	3.210E-3	3.970E-3
N° 5 (ON)	---	2.740E-3	2.890E-3	3.050E-3	4.880E-3
N° 6 (ON)	---	1.990E-3	1.990E-3	3.670E-3	4.430E-3
N° 7 (OFF)	---	2.900E-3	2.750E-3	2.290E-3	2.290E-3
N° 8 (OFF)	---	1.530E-3	1.680E-3	1.680E-3	1.980E-3
N° 9 (OFF)	---	1.680E-3	2.290E-3	1.530E-3	2.450E-3
N° 10 (OFF)	---	2.130E-3	1.220E-3	1.830E-3	2.740E-3
N° 11 (OFF)	---	1.670E-3	1.830E-3	1.520E-3	1.830E-3
Average (ON)	---	2.168E-3	1.984E-3	2.780E-3	3.878E-3
s (ON)	---	7.768E-4	6.471E-4	7.684E-4	8.246E-4
Average+3s (ON)	---	4.498E-3	3.925E-3	5.085E-3	6.352E-3
Average-3s (ON)	---	-1.625E-4	4.284E-5	4.747E-4	1.404E-3
Average (OFF)	---	1.982E-3	1.954E-3	1.770E-3	2.258E-3
s (OFF)	---	5.607E-4	5.865E-4	3.171E-4	3.642E-4
Average+3s (OFF)	---	3.664E-3	3.713E-3	2.721E-3	3.351E-3
Average-3s (OFF)	---	2.999E-4	1.946E-4	8.187E-4	1.165E-3

97. Vol_IO[12]

Ta = 25°C, Vcc = 3.3V, Iol = 8mA

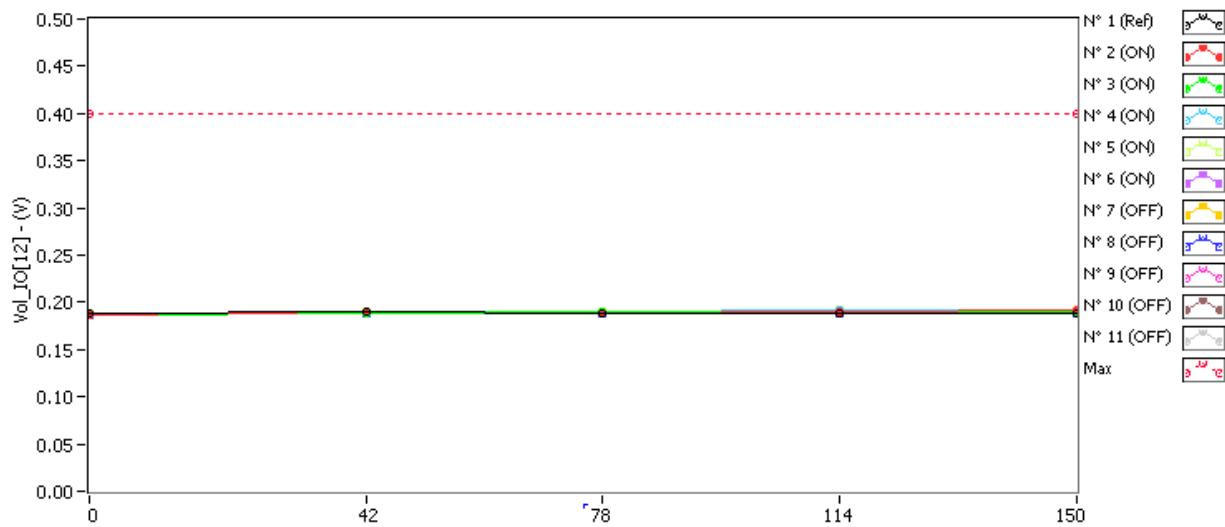

Vol_IO[12] . (V)

Max = 0.4

	0krad(Si)	42krad(Si)	78krad(Si)	114krad(Si)	150krad(Si)
N° 1 (Ref)	0.189	0.190	0.189	0.189	0.189
N° 2 (ON)	0.187	0.190	0.189	0.190	0.191
N° 3 (ON)	0.187	0.189	0.189	0.190	0.191
N° 4 (ON)	0.189	0.191	0.190	0.191	0.192
N° 5 (ON)	0.189	0.189	0.190	0.191	0.192
N° 6 (ON)	0.188	0.190	0.190	0.192	0.192
N° 7 (OFF)	0.188	0.191	0.190	0.190	0.190
N° 8 (OFF)	0.186	0.188	0.188	0.188	0.188
N° 9 (OFF)	0.187	0.189	0.190	0.189	0.190
N° 10 (OFF)	0.187	0.189	0.189	0.189	0.189
N° 11 (OFF)	0.187	0.189	0.188	0.189	0.189

Delta [Vol_IO[12]]

	0krad(Si)	42krad(Si)	78krad(Si)	114krad(Si)	150krad(Si)
N° 1 (Ref)	---	4.600E-4	-6.100E-4	-4.500E-4	0.000E+0
N° 2 (ON)	---	2.440E-3	2.130E-3	3.200E-3	4.270E-3
N° 3 (ON)	---	2.140E-3	2.450E-3	3.060E-3	3.970E-3
N° 4 (ON)	---	1.530E-3	1.370E-3	2.140E-3	2.900E-3
N° 5 (ON)	---	7.700E-4	1.680E-3	2.750E-3	3.360E-3
N° 6 (ON)	---	1.980E-3	1.830E-3	3.510E-3	3.810E-3
N° 7 (OFF)	---	2.900E-3	1.830E-3	2.290E-3	2.140E-3
N° 8 (OFF)	---	1.980E-3	2.290E-3	2.440E-3	2.440E-3
N° 9 (OFF)	---	2.130E-3	2.740E-3	1.830E-3	2.740E-3
N° 10 (OFF)	---	2.440E-3	1.990E-3	2.290E-3	1.990E-3
N° 11 (OFF)	---	1.830E-3	1.680E-3	1.830E-3	2.140E-3
Average (ON)	---	1.772E-3	1.892E-3	2.932E-3	3.662E-3
s (ON)	---	6.495E-4	4.151E-4	5.203E-4	5.381E-4
Average+3s (ON)	---	3.721E-3	3.137E-3	4.493E-3	5.276E-3
Average-3s (ON)	---	-1.765E-4	6.467E-4	1.371E-3	2.048E-3
Average (OFF)	---	2.256E-3	2.106E-3	2.136E-3	2.290E-3
s (OFF)	---	4.249E-4	4.204E-4	2.860E-4	3.000E-4
Average+3s (OFF)	---	3.531E-3	3.367E-3	2.994E-3	3.190E-3
Average-3s (OFF)	---	9.813E-4	8.448E-4	1.278E-3	1.390E-3

98. Vol_IO[13]

Ta = 25°C, Vcc = 3.3V, Iol = 8mA

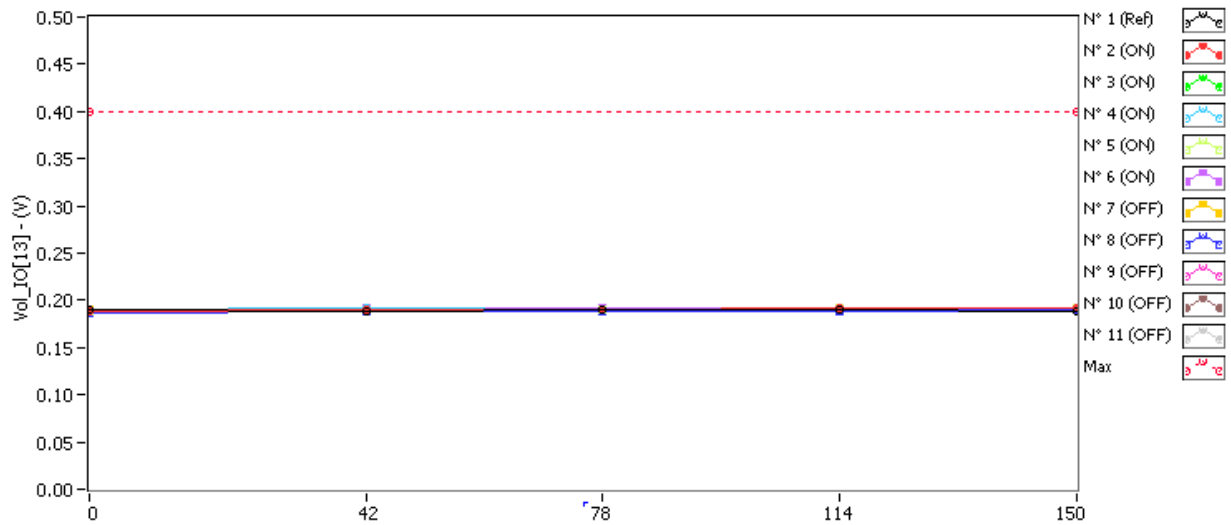

Vol_IO[13] . (V)

Max = 0.4

	0krad(Si)	42krad(Si)	78krad(Si)	114krad(Si)	150krad(Si)
N° 1 (Ref)	0.189	0.189	0.190	0.190	0.189
N° 2 (ON)	0.189	0.191	0.190	0.192	0.192
N° 3 (ON)	0.188	0.190	0.190	0.190	0.191
N° 4 (ON)	0.190	0.191	0.191	0.192	0.192
N° 5 (ON)	0.188	0.191	0.191	0.191	0.192
N° 6 (ON)	0.189	0.191	0.191	0.192	0.193
N° 7 (OFF)	0.190	0.192	0.191	0.192	0.192
N° 8 (OFF)	0.187	0.189	0.189	0.189	0.190
N° 9 (OFF)	0.188	0.190	0.190	0.190	0.190
N° 10 (OFF)	0.188	0.190	0.190	0.190	0.190
N° 11 (OFF)	0.187	0.190	0.189	0.190	0.190

Delta [Vol_IO[13]]

	0krad(Si)	42krad(Si)	78krad(Si)	114krad(Si)	150krad(Si)
N° 1 (Ref)	---	-3.100E-4	1.500E-4	1.500E-4	-6.100E-4
N° 2 (ON)	---	1.530E-3	7.700E-4	2.290E-3	2.290E-3
N° 3 (ON)	---	1.670E-3	2.130E-3	2.280E-3	3.200E-3
N° 4 (ON)	---	1.830E-3	1.220E-3	1.980E-3	2.590E-3
N° 5 (ON)	---	2.590E-3	2.290E-3	3.050E-3	3.360E-3
N° 6 (ON)	---	2.290E-3	2.440E-3	2.750E-3	3.810E-3
N° 7 (OFF)	---	2.290E-3	1.520E-3	1.980E-3	2.590E-3
N° 8 (OFF)	---	2.290E-3	2.140E-3	2.290E-3	3.050E-3
N° 9 (OFF)	---	2.140E-3	1.830E-3	2.140E-3	2.140E-3
N° 10 (OFF)	---	1.830E-3	1.830E-3	1.980E-3	2.290E-3
N° 11 (OFF)	---	2.600E-3	2.290E-3	2.600E-3	2.600E-3
Average (ON)	---	1.982E-3	1.770E-3	2.470E-3	3.050E-3
s (ON)	---	4.442E-4	7.334E-4	4.253E-4	6.094E-4
Average+3s (ON)	---	3.315E-3	3.970E-3	3.746E-3	4.878E-3
Average-3s (ON)	---	6.494E-4	-4.301E-4	1.194E-3	1.222E-3
Average (OFF)	---	2.230E-3	1.922E-3	2.198E-3	2.534E-3
s (OFF)	---	2.794E-4	3.006E-4	2.591E-4	3.495E-4
Average+3s (OFF)	---	3.068E-3	2.824E-3	2.975E-3	3.582E-3
Average-3s (OFF)	---	1.392E-3	1.020E-3	1.421E-3	1.486E-3

99. Vol_IO[14]

Ta = 25°C, Vcc = 3.3V, Iol = 8mA

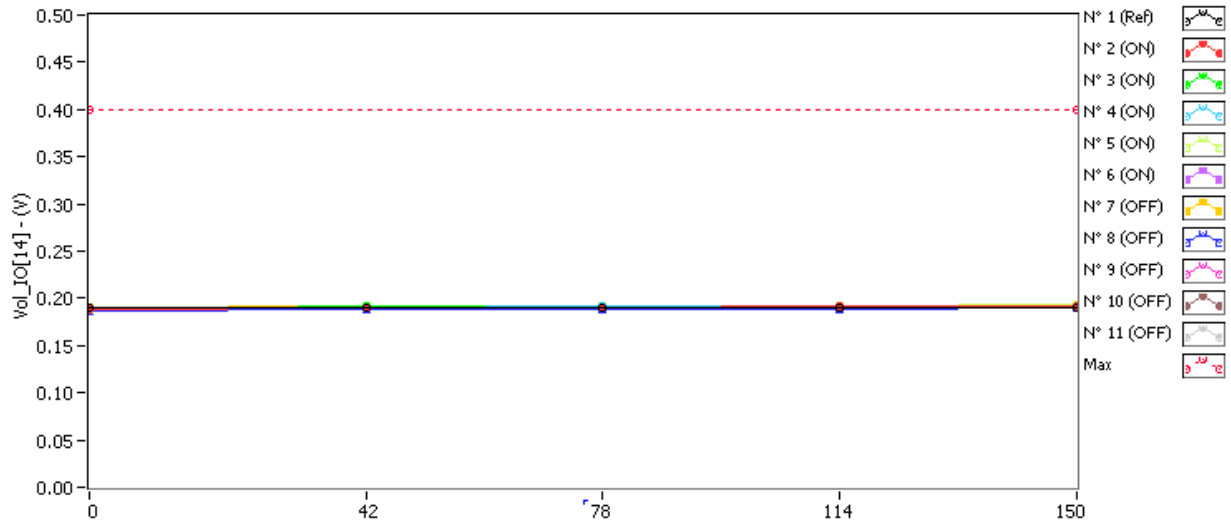

Vol_IO[14] . (V)

Max = 0.4

	0krad(Si)	42krad(Si)	78krad(Si)	114krad(Si)	150krad(Si)
N° 1 (Ref)	0.189	0.190	0.190	0.191	0.190
N° 2 (ON)	0.188	0.190	0.190	0.191	0.192
N° 3 (ON)	0.188	0.191	0.191	0.192	0.192
N° 4 (ON)	0.189	0.191	0.191	0.192	0.192
N° 5 (ON)	0.189	0.191	0.191	0.192	0.194
N° 6 (ON)	0.189	0.191	0.191	0.192	0.193
N° 7 (OFF)	0.190	0.192	0.191	0.192	0.192
N° 8 (OFF)	0.187	0.189	0.189	0.189	0.190
N° 9 (OFF)	0.188	0.190	0.190	0.190	0.191
N° 10 (OFF)	0.188	0.190	0.190	0.190	0.190
N° 11 (OFF)	0.187	0.190	0.189	0.190	0.190

Delta [Vol_IO[14]]

	0krad(Si)	42krad(Si)	78krad(Si)	114krad(Si)	150krad(Si)
N° 1 (Ref)	---	6.100E-4	3.000E-4	1.220E-3	3.000E-4
N° 2 (ON)	---	1.990E-3	1.680E-3	3.210E-3	4.120E-3
N° 3 (ON)	---	2.900E-3	2.290E-3	3.200E-3	3.200E-3
N° 4 (ON)	---	1.990E-3	1.830E-3	2.600E-3	2.900E-3
N° 5 (ON)	---	1.990E-3	2.140E-3	3.060E-3	4.280E-3
N° 6 (ON)	---	1.980E-3	2.290E-3	3.200E-3	3.970E-3
N° 7 (OFF)	---	2.140E-3	1.220E-3	1.840E-3	2.290E-3
N° 8 (OFF)	---	1.680E-3	1.520E-3	1.980E-3	2.440E-3
N° 9 (OFF)	---	2.140E-3	2.140E-3	2.440E-3	2.750E-3
N° 10 (OFF)	---	2.740E-3	2.590E-3	2.440E-3	2.740E-3
N° 11 (OFF)	---	2.750E-3	2.140E-3	2.750E-3	2.440E-3
Average (ON)	---	2.170E-3	2.046E-3	3.054E-3	3.694E-3
s (ON)	---	4.081E-4	2.777E-4	2.613E-4	6.074E-4
Average+3s (ON)	---	3.394E-3	2.879E-3	3.838E-3	5.516E-3
Average-3s (ON)	---	9.457E-4	1.213E-3	2.270E-3	1.872E-3
Average (OFF)	---	2.290E-3	1.922E-3	2.290E-3	2.532E-3
s (OFF)	---	4.559E-4	5.467E-4	3.726E-4	2.039E-4
Average+3s (OFF)	---	3.658E-3	3.562E-3	3.408E-3	3.144E-3
Average-3s (OFF)	---	9.224E-4	2.818E-4	1.172E-3	1.920E-3

100. Vol_IO[15]

Ta = 25°C, Vcc = 3.3V, Iol = 8mA

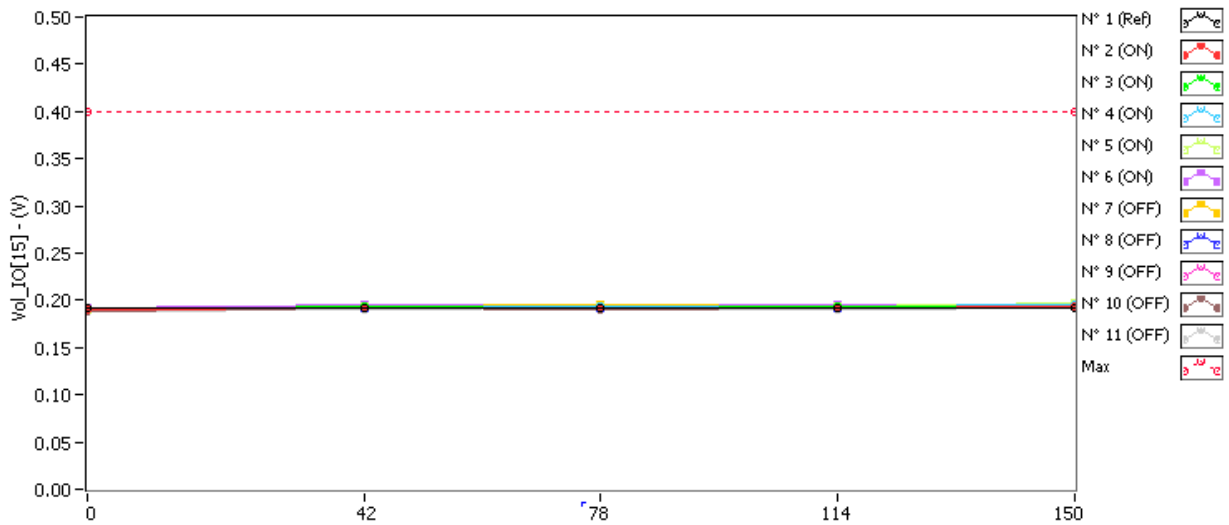

Vol_IO[15] . (V)

Max = 0.4

	0krad(Si)	42krad(Si)	78krad(Si)	114krad(Si)	150krad(Si)
N° 1 (Ref)	0.191	0.192	0.192	0.193	0.191
N° 2 (ON)	0.190	0.192	0.191	0.193	0.194
N° 3 (ON)	0.190	0.193	0.192	0.194	0.193
N° 4 (ON)	0.191	0.193	0.193	0.194	0.195
N° 5 (ON)	0.191	0.194	0.193	0.194	0.196
N° 6 (ON)	0.192	0.195	0.194	0.196	0.196
N° 7 (OFF)	0.192	0.194	0.195	0.194	0.194
N° 8 (OFF)	0.190	0.193	0.192	0.192	0.193
N° 9 (OFF)	0.191	0.193	0.192	0.193	0.193
N° 10 (OFF)	0.189	0.192	0.191	0.192	0.192
N° 11 (OFF)	0.189	0.191	0.191	0.191	0.191

Delta [Vol_IO[15]]

	0krad(Si)	42krad(Si)	78krad(Si)	114krad(Si)	150krad(Si)
N° 1 (Ref)	---	7.600E-4	9.200E-4	1.370E-3	0.000E+0
N° 2 (ON)	---	2.590E-3	1.680E-3	3.200E-3	3.970E-3
N° 3 (ON)	---	3.210E-3	1.830E-3	3.820E-3	3.510E-3
N° 4 (ON)	---	2.440E-3	2.290E-3	3.050E-3	4.120E-3
N° 5 (ON)	---	2.750E-3	2.290E-3	3.510E-3	5.500E-3
N° 6 (ON)	---	2.900E-3	2.290E-3	3.810E-3	4.120E-3
N° 7 (OFF)	---	2.140E-3	2.590E-3	2.140E-3	2.440E-3
N° 8 (OFF)	---	2.440E-3	1.830E-3	1.830E-3	3.050E-3
N° 9 (OFF)	---	1.680E-3	7.700E-4	1.830E-3	2.140E-3
N° 10 (OFF)	---	2.290E-3	1.530E-3	2.450E-3	2.450E-3
N° 11 (OFF)	---	1.980E-3	2.130E-3	1.980E-3	2.440E-3
Average (ON)	---	2.778E-3	2.076E-3	3.478E-3	4.244E-3
s (ON)	---	2.966E-4	2.978E-4	3.495E-4	7.453E-4
Average+3s (ON)	---	3.668E-3	2.969E-3	4.527E-3	6.480E-3
Average-3s (ON)	---	1.888E-3	1.183E-3	2.429E-3	2.008E-3
Average (OFF)	---	2.106E-3	1.770E-3	2.046E-3	2.504E-3
s (OFF)	---	2.932E-4	6.825E-4	2.597E-4	3.323E-4
Average+3s (OFF)	---	2.986E-3	3.817E-3	2.825E-3	3.501E-3
Average-3s (OFF)	---	1.226E-3	-2.775E-4	1.267E-3	1.507E-3

101. Voh_IO[0]

Ta = 25°C, Vcc = 3.3V, Ioh = -4mA

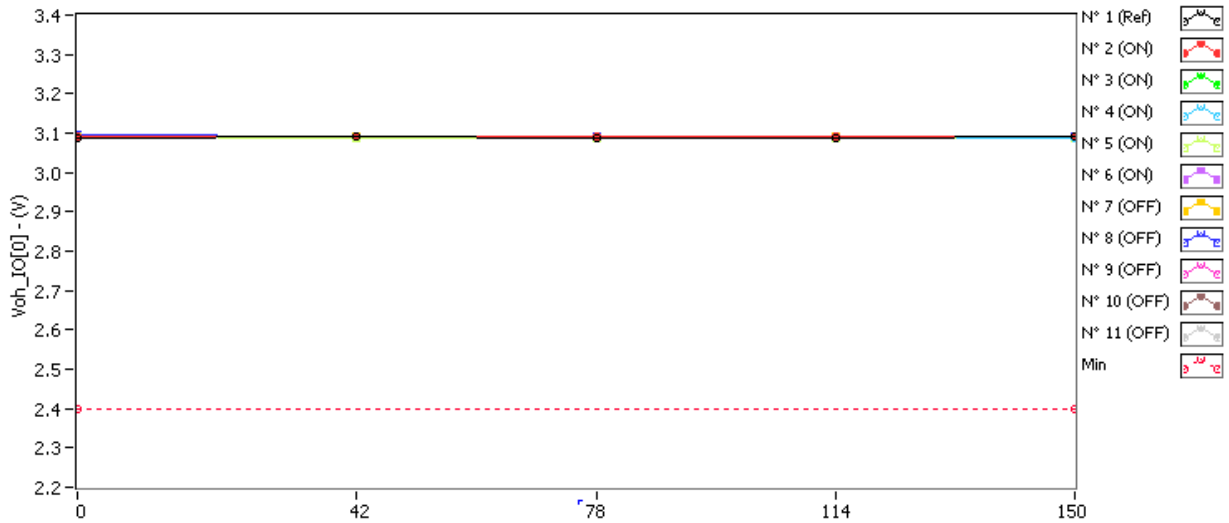

Voh_IO[0] . (V)

Min = 2.4

	0krad(Si)	42krad(Si)	78krad(Si)	114krad(Si)	150krad(Si)
N° 1 (Ref)	3.088	3.090	3.089	3.088	3.090
N° 2 (ON)	3.093	3.091	3.091	3.091	3.090
N° 3 (ON)	3.092	3.090	3.091	3.089	3.090
N° 4 (ON)	3.093	3.092	3.091	3.090	3.089
N° 5 (ON)	3.090	3.089	3.088	3.087	3.087
N° 6 (ON)	3.090	3.087	3.087	3.086	3.086
N° 7 (OFF)	3.091	3.090	3.089	3.090	3.088
N° 8 (OFF)	3.094	3.093	3.093	3.093	3.093
N° 9 (OFF)	3.091	3.089	3.089	3.089	3.088
N° 10 (OFF)	3.091	3.090	3.091	3.091	3.090
N° 11 (OFF)	3.090	3.091	3.090	3.089	3.089

Delta [Voh_IO[0]]

	0krad(Si)	42krad(Si)	78krad(Si)	114krad(Si)	150krad(Si)
N° 1 (Ref)	---	1.500E-3	1.100E-3	0.000E+0	1.800E-3
N° 2 (ON)	---	-1.300E-3	-1.500E-3	-1.600E-3	-2.700E-3
N° 3 (ON)	---	-2.000E-3	-1.200E-3	-2.900E-3	-2.300E-3
N° 4 (ON)	---	-1.500E-3	-2.400E-3	-2.900E-3	-4.600E-3
N° 5 (ON)	---	-1.400E-3	-2.100E-3	-3.200E-3	-2.800E-3
N° 6 (ON)	---	-2.700E-3	-2.600E-3	-4.200E-3	-4.400E-3
N° 7 (OFF)	---	-1.800E-3	-2.100E-3	-1.800E-3	-2.900E-3
N° 8 (OFF)	---	-1.600E-3	-1.100E-3	-1.400E-3	-1.400E-3
N° 9 (OFF)	---	-1.800E-3	-2.000E-3	-1.800E-3	-2.700E-3
N° 10 (OFF)	---	-1.100E-3	-1.000E-4	-6.000E-4	-1.500E-3
N° 11 (OFF)	---	7.000E-4	1.000E-4	-8.000E-4	-8.000E-4
Average (ON)	---	-1.780E-3	-1.960E-3	-2.960E-3	-3.360E-3
s (ON)	---	5.805E-4	5.941E-4	9.290E-4	1.060E-3
Average+3s (ON)	---	-3.845E-5	-1.776E-4	-1.731E-4	-1.808E-4
Average-3s (ON)	---	-3.522E-3	-3.742E-3	-5.747E-3	-6.539E-3
Average (OFF)	---	-1.120E-3	-1.040E-3	-1.280E-3	-1.860E-3
s (OFF)	---	1.057E-3	1.029E-3	5.586E-4	9.017E-4
Average+3s (OFF)	---	2.051E-3	2.046E-3	3.957E-4	8.450E-4
Average-3s (OFF)	---	-4.291E-3	-4.126E-3	-2.956E-3	-4.565E-3

102. Voh_IO[1]

Ta = 25°C, Vcc = 3.3V, Ioh = -4mA

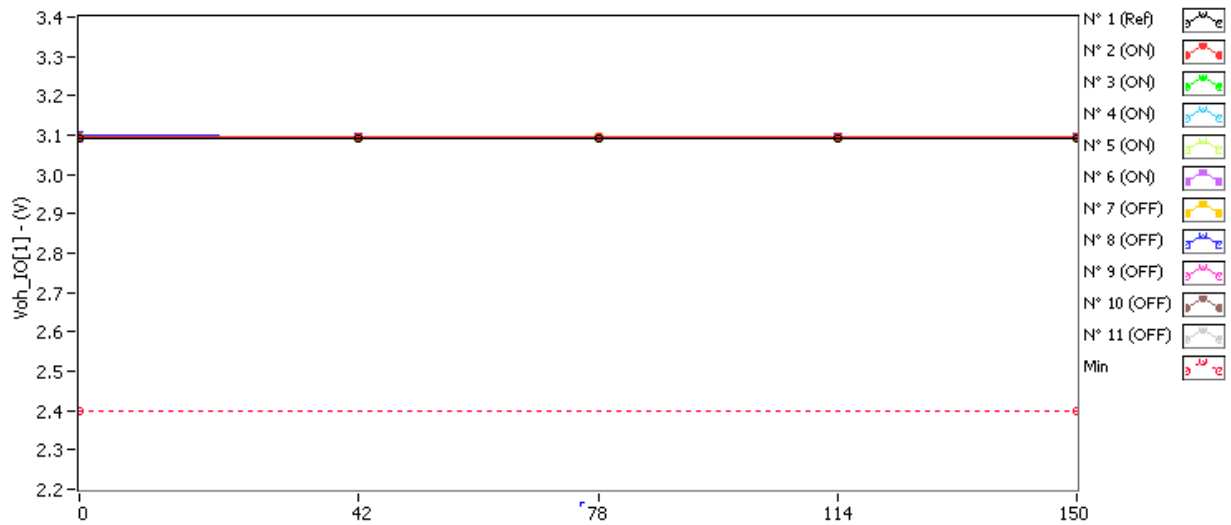

Voh_IO[1] . (V)

Min = 2.4

	0krad(Si)	42krad(Si)	78krad(Si)	114krad(Si)	150krad(Si)
N° 1 (Ref)	3.093	3.092	3.093	3.093	3.093
N° 2 (ON)	3.096	3.095	3.095	3.094	3.094
N° 3 (ON)	3.096	3.094	3.094	3.094	3.093
N° 4 (ON)	3.097	3.095	3.094	3.095	3.093
N° 5 (ON)	3.094	3.091	3.093	3.091	3.090
N° 6 (ON)	3.093	3.091	3.091	3.090	3.090
N° 7 (OFF)	3.095	3.093	3.094	3.092	3.092
N° 8 (OFF)	3.099	3.097	3.098	3.097	3.096
N° 9 (OFF)	3.095	3.092	3.093	3.093	3.091
N° 10 (OFF)	3.096	3.094	3.095	3.095	3.093
N° 11 (OFF)	3.095	3.094	3.094	3.094	3.092

Delta [Voh_IO[1]]

	0krad(Si)	42krad(Si)	78krad(Si)	114krad(Si)	150krad(Si)
N° 1 (Ref)	---	-6.000E-4	2.000E-4	2.000E-4	0.000E+0
N° 2 (ON)	---	-1.400E-3	-1.400E-3	-1.800E-3	-2.300E-3
N° 3 (ON)	---	-2.000E-3	-1.800E-3	-2.600E-3	-2.900E-3
N° 4 (ON)	---	-1.300E-3	-2.300E-3	-2.200E-3	-4.000E-3
N° 5 (ON)	---	-3.100E-3	-1.700E-3	-3.100E-3	-4.000E-3
N° 6 (ON)	---	-2.200E-3	-2.100E-3	-3.300E-3	-3.200E-3
N° 7 (OFF)	---	-2.400E-3	-1.300E-3	-3.000E-3	-2.900E-3
N° 8 (OFF)	---	-1.100E-3	-9.000E-4	-1.200E-3	-2.600E-3
N° 9 (OFF)	---	-2.600E-3	-1.700E-3	-2.000E-3	-3.200E-3
N° 10 (OFF)	---	-1.200E-3	-3.000E-4	-1.100E-3	-2.200E-3
N° 11 (OFF)	---	-1.400E-3	-1.100E-3	-1.400E-3	-3.200E-3
Average (ON)	---	-2.000E-3	-1.860E-3	-2.600E-3	-3.280E-3
s (ON)	---	7.246E-4	3.507E-4	6.205E-4	7.328E-4
Average+3s (ON)	---	1.737E-4	-8.079E-4	-7.385E-4	-1.082E-3
Average-3s (ON)	---	-4.174E-3	-2.912E-3	-4.461E-3	-5.478E-3
Average (OFF)	---	-1.740E-3	-1.060E-3	-1.740E-3	-2.820E-3
s (OFF)	---	7.057E-4	5.177E-4	7.861E-4	4.266E-4
Average+3s (OFF)	---	3.771E-4	4.931E-4	6.184E-4	-1.540E-3
Average-3s (OFF)	---	-3.857E-3	-2.613E-3	-4.098E-3	-4.100E-3

103. Voh_IO[2]

Ta = 25°C, Vcc = 3.3V, Ioh = -4mA

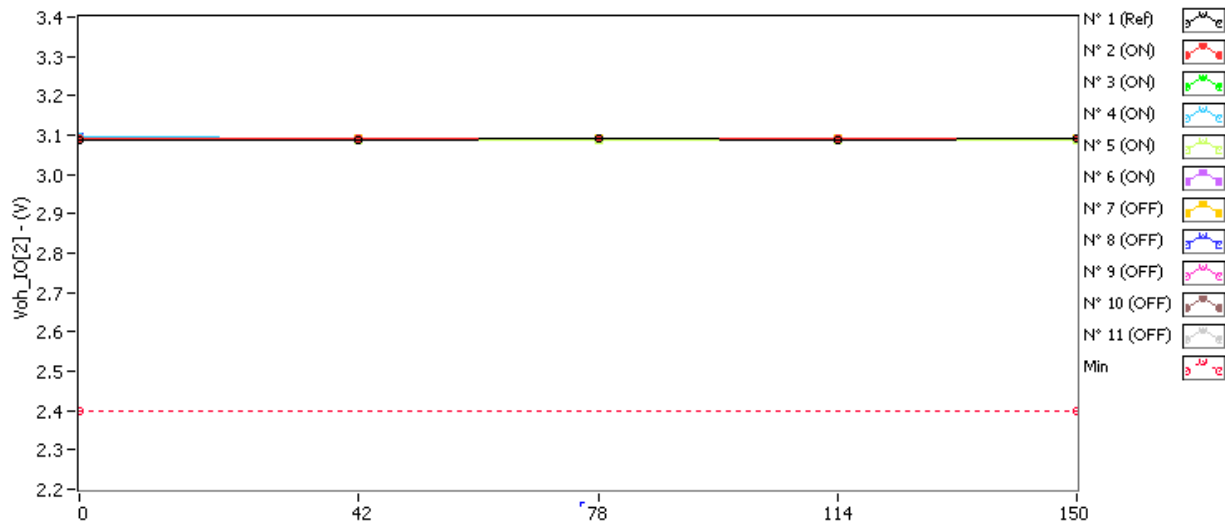

Voh_IO[2] . (V)

Min = 2.4

	0krad(Si)	42krad(Si)	78krad(Si)	114krad(Si)	150krad(Si)
N° 1 (Ref)	3.089	3.089	3.090	3.089	3.090
N° 2 (ON)	3.093	3.091	3.092	3.090	3.091
N° 3 (ON)	3.093	3.090	3.091	3.091	3.090
N° 4 (ON)	3.094	3.092	3.092	3.091	3.090
N° 5 (ON)	3.091	3.088	3.089	3.087	3.087
N° 6 (ON)	3.090	3.089	3.088	3.087	3.086
N° 7 (OFF)	3.092	3.091	3.090	3.090	3.090
N° 8 (OFF)	3.095	3.093	3.094	3.094	3.092
N° 9 (OFF)	3.091	3.090	3.089	3.089	3.089
N° 10 (OFF)	3.092	3.091	3.091	3.091	3.090
N° 11 (OFF)	3.091	3.091	3.091	3.090	3.089

Delta [Voh_IO[2]]

	0krad(Si)	42krad(Si)	78krad(Si)	114krad(Si)	150krad(Si)
N° 1 (Ref)	---	-1.000E-4	3.000E-4	-1.000E-4	5.000E-4
N° 2 (ON)	---	-1.300E-3	-1.200E-3	-2.900E-3	-2.100E-3
N° 3 (ON)	---	-2.800E-3	-2.000E-3	-2.300E-3	-2.600E-3
N° 4 (ON)	---	-2.300E-3	-2.500E-3	-3.200E-3	-4.500E-3
N° 5 (ON)	---	-2.100E-3	-1.900E-3	-3.000E-3	-3.200E-3
N° 6 (ON)	---	-1.400E-3	-1.800E-3	-3.100E-3	-3.800E-3
N° 7 (OFF)	---	-1.400E-3	-1.900E-3	-2.600E-3	-2.300E-3
N° 8 (OFF)	---	-1.400E-3	-9.000E-4	-9.000E-4	-2.300E-3
N° 9 (OFF)	---	-1.200E-3	-1.700E-3	-2.100E-3	-2.000E-3
N° 10 (OFF)	---	-1.500E-3	-1.300E-3	-1.700E-3	-2.400E-3
N° 11 (OFF)	---	-8.000E-4	-3.000E-4	-1.100E-3	-2.200E-3
Average (ON)	---	-1.980E-3	-1.880E-3	-2.900E-3	-3.240E-3
s (ON)	---	6.301E-4	4.658E-4	3.536E-4	9.503E-4
Average+3s (ON)	---	-8.976E-5	-4.825E-4	-1.839E-3	-3.892E-4
Average-3s (ON)	---	-3.870E-3	-3.277E-3	-3.961E-3	-6.091E-3
Average (OFF)	---	-1.260E-3	-1.220E-3	-1.680E-3	-2.240E-3
s (OFF)	---	2.793E-4	6.419E-4	7.014E-4	1.517E-4
Average+3s (OFF)	---	-4.221E-4	7.056E-4	4.243E-4	-1.785E-3
Average-3s (OFF)	---	-2.098E-3	-3.146E-3	-3.784E-3	-2.695E-3

104. Voh_IO[3]

Ta = 25°C, Vcc = 3.3V, Ioh = -4mA

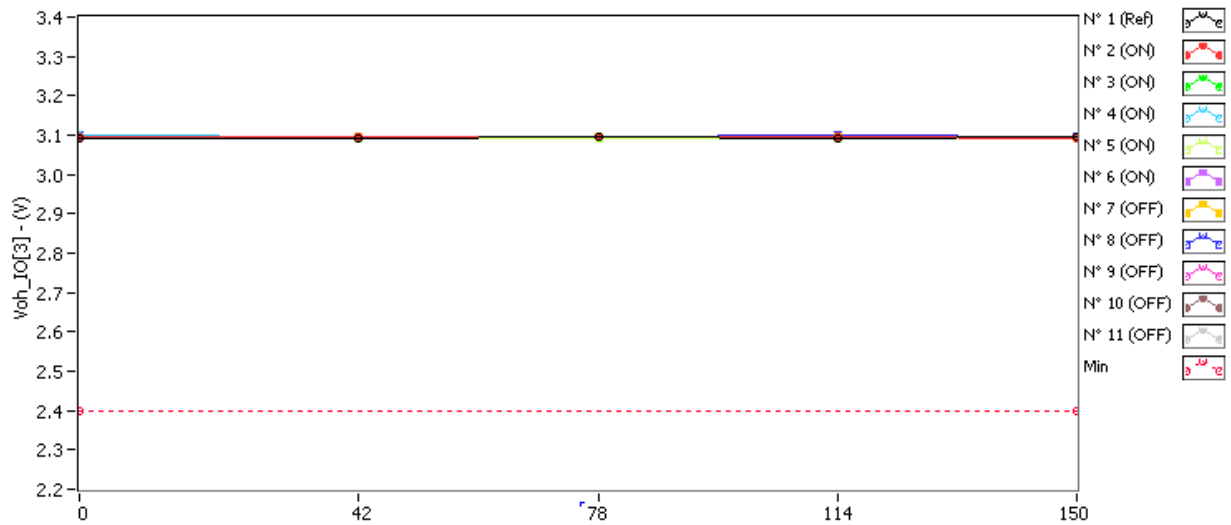

Voh_IO[3] . (V)

Min = 2.4

	0krad(Si)	42krad(Si)	78krad(Si)	114krad(Si)	150krad(Si)
N° 1 (Ref)	3.094	3.092	3.094	3.093	3.094
N° 2 (ON)	3.097	3.095	3.096	3.095	3.094
N° 3 (ON)	3.097	3.096	3.095	3.095	3.094
N° 4 (ON)	3.099	3.096	3.096	3.095	3.095
N° 5 (ON)	3.095	3.093	3.093	3.092	3.092
N° 6 (ON)	3.094	3.092	3.092	3.092	3.091
N° 7 (OFF)	3.097	3.095	3.095	3.095	3.093
N° 8 (OFF)	3.098	3.098	3.097	3.099	3.097
N° 9 (OFF)	3.095	3.093	3.094	3.094	3.093
N° 10 (OFF)	3.097	3.096	3.095	3.094	3.094
N° 11 (OFF)	3.096	3.094	3.096	3.094	3.093

Delta [Voh_IO[3]]

	0krad(Si)	42krad(Si)	78krad(Si)	114krad(Si)	150krad(Si)
N° 1 (Ref)	---	-1.100E-3	2.000E-4	-2.000E-4	2.000E-4
N° 2 (ON)	---	-2.200E-3	-1.400E-3	-2.000E-3	-3.700E-3
N° 3 (ON)	---	-1.200E-3	-1.400E-3	-2.300E-3	-3.200E-3
N° 4 (ON)	---	-2.900E-3	-2.900E-3	-4.100E-3	-4.100E-3
N° 5 (ON)	---	-2.400E-3	-2.100E-3	-3.200E-3	-3.800E-3
N° 6 (ON)	---	-1.900E-3	-1.900E-3	-2.600E-3	-3.500E-3
N° 7 (OFF)	---	-2.000E-3	-2.000E-3	-2.400E-3	-4.000E-3
N° 8 (OFF)	---	-7.000E-4	-1.300E-3	2.000E-4	-1.600E-3
N° 9 (OFF)	---	-1.900E-3	-1.400E-3	-1.700E-3	-2.600E-3
N° 10 (OFF)	---	-1.700E-3	-2.300E-3	-3.000E-3	-3.000E-3
N° 11 (OFF)	---	-1.600E-3	-1.000E-4	-1.300E-3	-2.300E-3
Average (ON)	---	-2.120E-3	-1.940E-3	-2.840E-3	-3.660E-3
s (ON)	---	6.301E-4	6.189E-4	8.325E-4	3.362E-4
Average+3s (ON)	---	-2.298E-4	-8.339E-5	-3.426E-4	-2.652E-3
Average-3s (ON)	---	-4.010E-3	-3.797E-3	-5.337E-3	-4.668E-3
Average (OFF)	---	-1.580E-3	-1.420E-3	-1.640E-3	-2.700E-3
s (OFF)	---	5.167E-4	8.468E-4	1.218E-3	8.888E-4
Average+3s (OFF)	---	-2.984E-5	1.120E-3	2.013E-3	-3.354E-5
Average-3s (OFF)	---	-3.130E-3	-3.960E-3	-5.293E-3	-5.366E-3

105. Voh_IO[4]

Ta = 25°C, Vcc = 3.3V, Ioh = -4mA

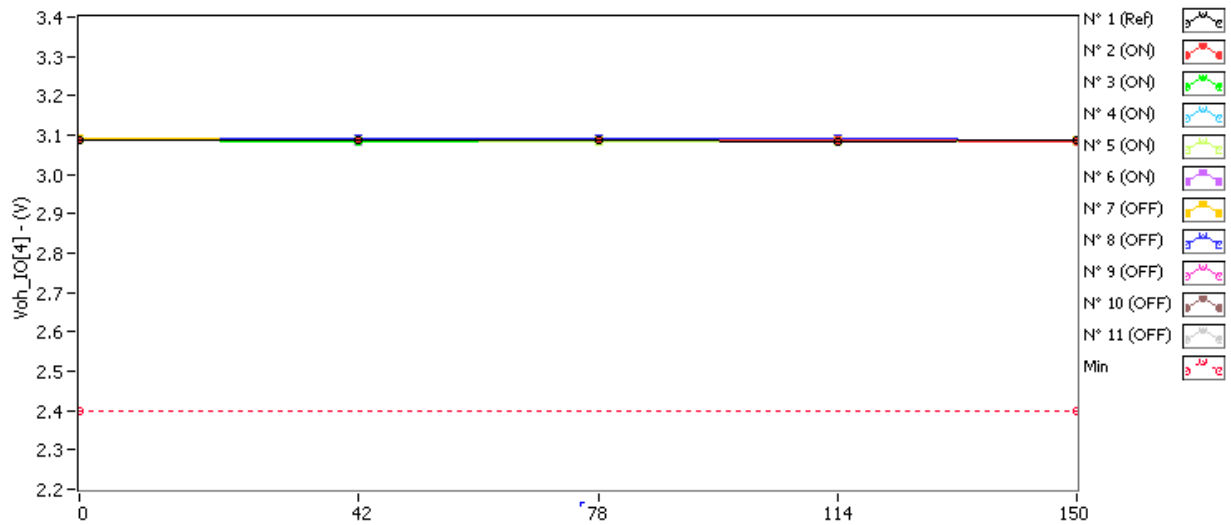

Voh_IO[4] . (V)

Min = 2.4

	0krad(Si)	42krad(Si)	78krad(Si)	114krad(Si)	150krad(Si)
N° 1 (Ref)	3.085	3.085	3.086	3.084	3.085
N° 2 (ON)	3.088	3.086	3.086	3.086	3.084
N° 3 (ON)	3.088	3.085	3.086	3.085	3.085
N° 4 (ON)	3.089	3.087	3.087	3.086	3.084
N° 5 (ON)	3.088	3.086	3.085	3.085	3.084
N° 6 (ON)	3.086	3.084	3.084	3.084	3.082
N° 7 (OFF)	3.090	3.088	3.087	3.088	3.086
N° 8 (OFF)	3.091	3.090	3.090	3.090	3.089
N° 9 (OFF)	3.087	3.086	3.086	3.085	3.085
N° 10 (OFF)	3.089	3.086	3.087	3.086	3.086
N° 11 (OFF)	3.087	3.085	3.085	3.084	3.084

Delta [Voh_IO[4]]

	0krad(Si)	42krad(Si)	78krad(Si)	114krad(Si)	150krad(Si)
N° 1 (Ref)	---	0.000E+0	9.000E-4	-1.300E-3	0.000E+0
N° 2 (ON)	---	-1.800E-3	-2.000E-3	-1.700E-3	-3.800E-3
N° 3 (ON)	---	-3.200E-3	-1.700E-3	-2.700E-3	-3.500E-3
N° 4 (ON)	---	-1.800E-3	-2.300E-3	-3.300E-3	-5.300E-3
N° 5 (ON)	---	-1.700E-3	-2.600E-3	-3.100E-3	-3.900E-3
N° 6 (ON)	---	-1.600E-3	-1.300E-3	-2.000E-3	-3.500E-3
N° 7 (OFF)	---	-1.500E-3	-2.600E-3	-2.100E-3	-3.400E-3
N° 8 (OFF)	---	-1.400E-3	-1.400E-3	-1.100E-3	-1.700E-3
N° 9 (OFF)	---	-1.500E-3	-6.000E-4	-2.200E-3	-2.400E-3
N° 10 (OFF)	---	-2.700E-3	-2.000E-3	-2.300E-3	-3.000E-3
N° 11 (OFF)	---	-2.000E-3	-2.100E-3	-2.800E-3	-2.800E-3
Average (ON)	---	-2.020E-3	-1.980E-3	-2.560E-3	-4.000E-3
s (ON)	---	6.648E-4	5.070E-4	6.914E-4	7.483E-4
Average+3s (ON)	---	-2.551E-5	-4.591E-4	-4.859E-4	-1.755E-3
Average-3s (ON)	---	-4.014E-3	-3.501E-3	-4.634E-3	-6.245E-3
Average (OFF)	---	-1.820E-3	-1.740E-3	-2.100E-3	-2.660E-3
s (OFF)	---	5.450E-4	7.668E-4	6.205E-4	6.465E-4
Average+3s (OFF)	---	-1.851E-4	5.604E-4	-2.385E-4	-7.204E-4
Average-3s (OFF)	---	-3.455E-3	-4.040E-3	-3.961E-3	-4.600E-3

106. Voh_IO[5]

Ta = 25°C, Vcc = 3.3V, Ioh = -4mA

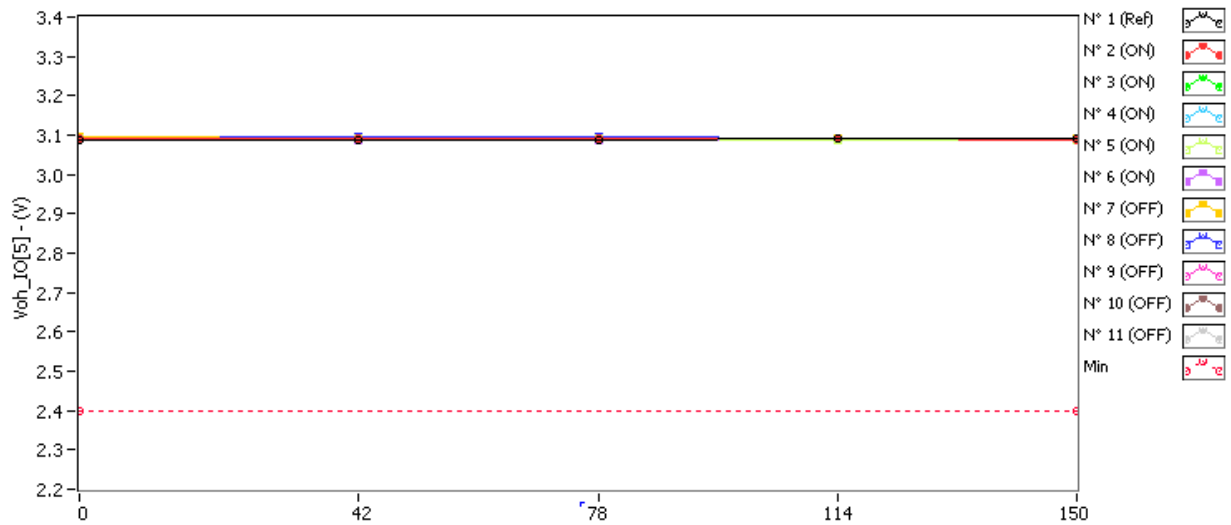

Voh_IO[5] . (V)

Min = 2.4

	0krad(Si)	42krad(Si)	78krad(Si)	114krad(Si)	150krad(Si)
N° 1 (Ref)	3.089	3.089	3.089	3.090	3.090
N° 2 (ON)	3.092	3.090	3.091	3.090	3.089
N° 3 (ON)	3.092	3.091	3.091	3.091	3.090
N° 4 (ON)	3.093	3.092	3.092	3.090	3.089
N° 5 (ON)	3.092	3.090	3.090	3.089	3.089
N° 6 (ON)	3.091	3.088	3.089	3.088	3.086
N° 7 (OFF)	3.094	3.091	3.092	3.092	3.091
N° 8 (OFF)	3.096	3.094	3.094	3.094	3.093
N° 9 (OFF)	3.092	3.090	3.090	3.090	3.090
N° 10 (OFF)	3.093	3.092	3.092	3.092	3.091
N° 11 (OFF)	3.092	3.091	3.091	3.090	3.089

Delta [Voh_IO[5]]

	0krad(Si)	42krad(Si)	78krad(Si)	114krad(Si)	150krad(Si)
N° 1 (Ref)	---	0.000E+0	-2.000E-4	4.000E-4	6.000E-4
N° 2 (ON)	---	-1.800E-3	-1.200E-3	-2.600E-3	-3.500E-3
N° 3 (ON)	---	-1.400E-3	-1.200E-3	-1.900E-3	-2.500E-3
N° 4 (ON)	---	-1.300E-3	-1.600E-3	-3.200E-3	-4.700E-3
N° 5 (ON)	---	-2.600E-3	-2.300E-3	-3.400E-3	-3.200E-3
N° 6 (ON)	---	-2.600E-3	-1.800E-3	-3.300E-3	-4.700E-3
N° 7 (OFF)	---	-2.700E-3	-2.300E-3	-2.300E-3	-3.200E-3
N° 8 (OFF)	---	-1.800E-3	-2.100E-3	-2.400E-3	-2.600E-3
N° 9 (OFF)	---	-2.500E-3	-2.000E-3	-2.800E-3	-2.800E-3
N° 10 (OFF)	---	-1.800E-3	-1.200E-3	-1.800E-3	-2.700E-3
N° 11 (OFF)	---	-1.400E-3	-1.200E-3	-1.700E-3	-2.700E-3
Average (ON)	---	-1.940E-3	-1.620E-3	-2.880E-3	-3.720E-3
s (ON)	---	6.309E-4	4.604E-4	6.301E-4	9.654E-4
Average+3s (ON)	---	-4.738E-5	-2.387E-4	-9.898E-4	-8.238E-4
Average-3s (ON)	---	-3.833E-3	-3.001E-3	-4.770E-3	-6.616E-3
Average (OFF)	---	-2.040E-3	-1.760E-3	-2.200E-3	-2.800E-3
s (OFF)	---	5.413E-4	5.225E-4	4.528E-4	2.345E-4
Average+3s (OFF)	---	-4.161E-4	-1.925E-4	-8.417E-4	-2.096E-3
Average-3s (OFF)	---	-3.664E-3	-3.327E-3	-3.558E-3	-3.504E-3

107. Voh_IO[6]

Ta = 25°C, Vcc = 3.3V, Ioh = -4mA

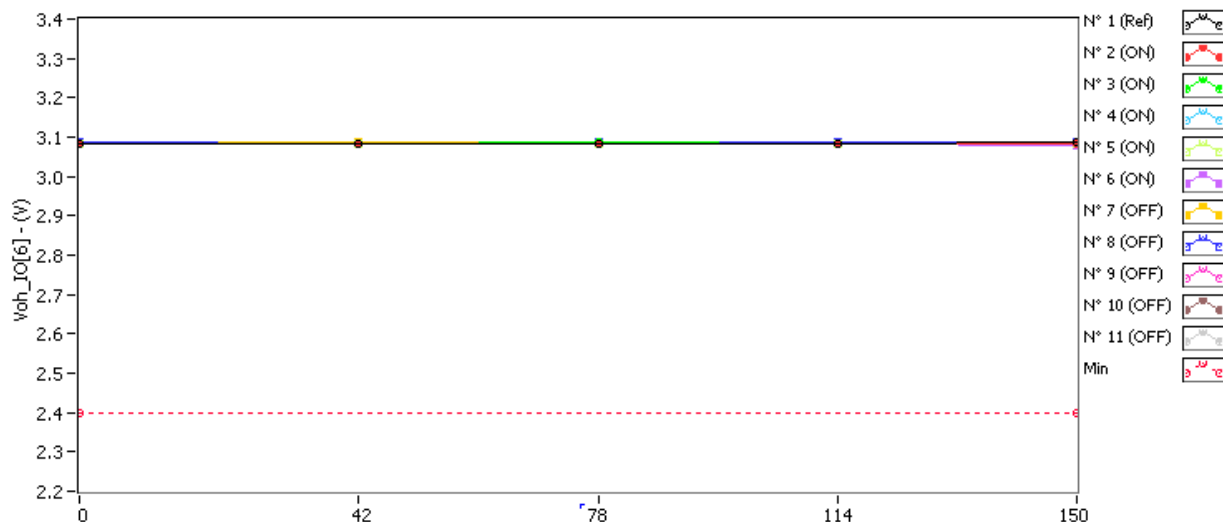

Voh_IO[6] . (V)

Min = 2.4

	0krad(Si)	42krad(Si)	78krad(Si)	114krad(Si)	150krad(Si)
N° 1 (Ref)	3.082	3.085	3.085	3.084	3.085
N° 2 (ON)	3.084	3.085	3.085	3.084	3.083
N° 3 (ON)	3.085	3.085	3.086	3.084	3.084
N° 4 (ON)	3.085	3.085	3.086	3.085	3.082
N° 5 (ON)	3.083	3.084	3.084	3.083	3.083
N° 6 (ON)	3.083	3.082	3.082	3.081	3.080
N° 7 (OFF)	3.085	3.086	3.085	3.084	3.085
N° 8 (OFF)	3.088	3.089	3.088	3.089	3.088
N° 9 (OFF)	3.084	3.085	3.086	3.084	3.084
N° 10 (OFF)	3.085	3.085	3.086	3.086	3.085
N° 11 (OFF)	3.083	3.084	3.084	3.084	3.083

Delta [Voh_IO[6]]

	0krad(Si)	42krad(Si)	78krad(Si)	114krad(Si)	150krad(Si)
N° 1 (Ref)	---	2.700E-3	2.900E-3	2.100E-3	3.500E-3
N° 2 (ON)	---	1.100E-3	1.200E-3	7.000E-4	-3.000E-4
N° 3 (ON)	---	2.000E-4	6.000E-4	-9.000E-4	-9.000E-4
N° 4 (ON)	---	1.000E-4	9.000E-4	-5.000E-4	-3.100E-3
N° 5 (ON)	---	6.000E-4	6.000E-4	3.000E-4	-6.000E-4
N° 6 (ON)	---	-9.000E-4	-9.000E-4	-1.700E-3	-2.500E-3
N° 7 (OFF)	---	7.000E-4	0.000E+0	-8.000E-4	0.000E+0
N° 8 (OFF)	---	1.000E-3	-2.000E-4	7.000E-4	1.000E-4
N° 9 (OFF)	---	5.000E-4	1.600E-3	0.000E+0	-3.000E-4
N° 10 (OFF)	---	-1.000E-4	6.000E-4	6.000E-4	0.000E+0
N° 11 (OFF)	---	5.000E-4	8.000E-4	6.000E-4	-7.000E-4
Average (ON)	---	2.200E-4	4.800E-4	-4.200E-4	-1.480E-3
s (ON)	---	7.396E-4	8.106E-4	9.550E-4	1.242E-3
Average+3s (ON)	---	2.439E-3	2.912E-3	2.445E-3	2.245E-3
Average-3s (ON)	---	-1.999E-3	-1.952E-3	-3.285E-3	-5.205E-3
Average (OFF)	---	5.200E-4	5.600E-4	2.200E-4	-1.800E-4
s (OFF)	---	4.025E-4	7.127E-4	6.340E-4	3.271E-4
Average+3s (OFF)	---	1.727E-3	2.698E-3	2.122E-3	8.013E-4
Average-3s (OFF)	---	-6.875E-4	-1.578E-3	-1.682E-3	-1.161E-3

108. Voh_IO[7]

Ta = 25°C, Vcc = 3.3V, Ioh = -4mA

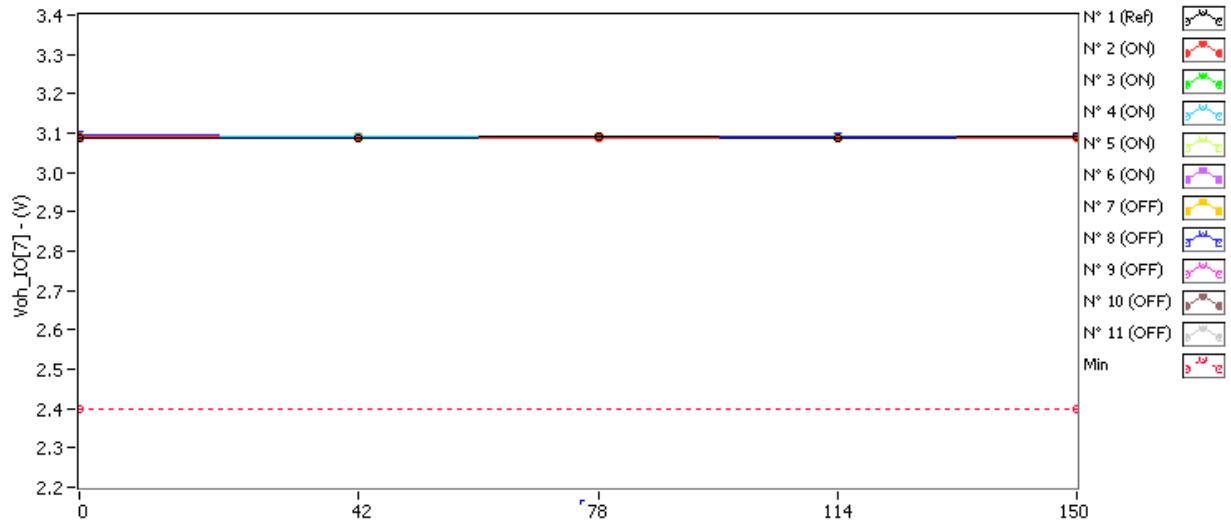

Voh_IO[7] . (V)

Min = 2.4

	0krad(Si)	42krad(Si)	78krad(Si)	114krad(Si)	150krad(Si)
N° 1 (Ref)	3.089	3.089	3.090	3.089	3.090
N° 2 (ON)	3.090	3.088	3.089	3.087	3.087
N° 3 (ON)	3.091	3.089	3.089	3.088	3.088
N° 4 (ON)	3.092	3.090	3.090	3.088	3.087
N° 5 (ON)	3.091	3.089	3.089	3.087	3.087
N° 6 (ON)	3.089	3.087	3.087	3.086	3.085
N° 7 (OFF)	3.092	3.090	3.090	3.089	3.088
N° 8 (OFF)	3.094	3.093	3.093	3.093	3.092
N° 9 (OFF)	3.091	3.089	3.090	3.089	3.088
N° 10 (OFF)	3.092	3.090	3.091	3.089	3.090
N° 11 (OFF)	3.090	3.089	3.088	3.088	3.087

Delta [Voh_IO[7]]

	0krad(Si)	42krad(Si)	78krad(Si)	114krad(Si)	150krad(Si)
N° 1 (Ref)	---	2.000E-4	9.000E-4	5.000E-4	8.000E-4
N° 2 (ON)	---	-2.200E-3	-1.200E-3	-2.700E-3	-3.000E-3
N° 3 (ON)	---	-1.300E-3	-1.300E-3	-2.100E-3	-2.700E-3
N° 4 (ON)	---	-1.700E-3	-1.700E-3	-3.600E-3	-4.100E-3
N° 5 (ON)	---	-1.900E-3	-1.900E-3	-3.200E-3	-3.900E-3
N° 6 (ON)	---	-1.900E-3	-2.300E-3	-3.400E-3	-3.800E-3
N° 7 (OFF)	---	-1.700E-3	-1.500E-3	-2.700E-3	-3.500E-3
N° 8 (OFF)	---	-1.700E-3	-1.400E-3	-1.300E-3	-2.300E-3
N° 9 (OFF)	---	-2.600E-3	-1.700E-3	-2.600E-3	-2.800E-3
N° 10 (OFF)	---	-1.900E-3	-1.400E-3	-2.800E-3	-2.600E-3
N° 11 (OFF)	---	-6.000E-4	-1.900E-3	-1.600E-3	-2.300E-3
Average (ON)	---	-1.800E-3	-1.680E-3	-3.000E-3	-3.500E-3
s (ON)	---	3.317E-4	4.494E-4	6.042E-4	6.124E-4
Average+3s (ON)	---	-8.050E-4	-3.317E-4	-1.188E-3	-1.663E-3
Average-3s (ON)	---	-2.795E-3	-3.028E-3	-4.812E-3	-5.337E-3
Average (OFF)	---	-1.700E-3	-1.580E-3	-2.200E-3	-2.700E-3
s (OFF)	---	7.176E-4	2.168E-4	6.964E-4	4.950E-4
Average+3s (OFF)	---	4.529E-4	-9.296E-4	-1.107E-3	-1.215E-3
Average-3s (OFF)	---	-3.853E-3	-2.230E-3	-4.289E-3	-4.185E-3

109. Voh_IO[8]

Ta = 25°C, Vcc = 3.3V, Ioh = -4mA

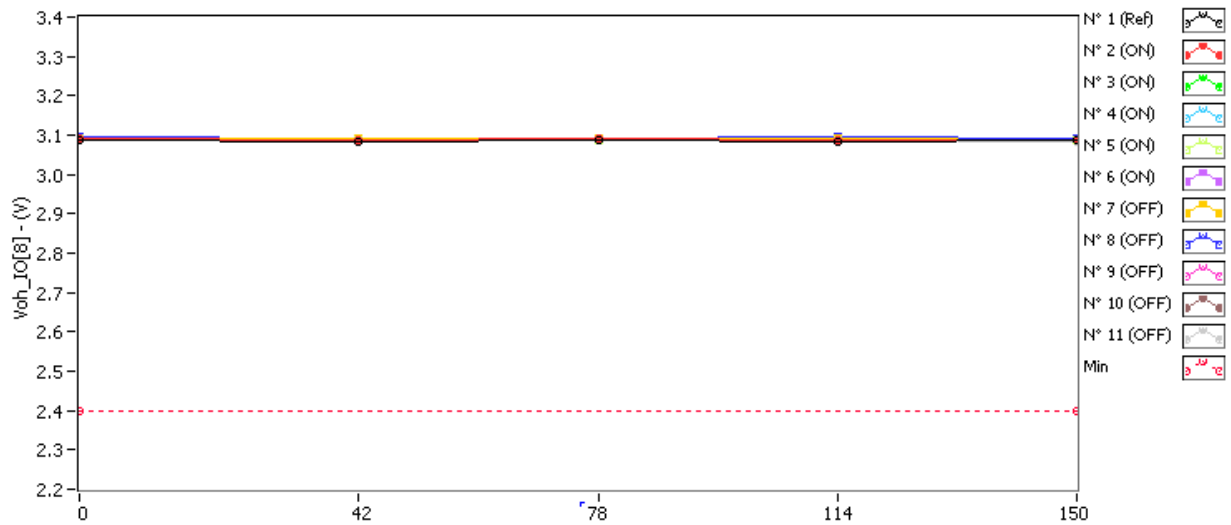

Voh_IO[8] . (V)

Min = 2.4

	0krad(Si)	42krad(Si)	78krad(Si)	114krad(Si)	150krad(Si)
N° 1 (Ref)	3.086	3.085	3.086	3.085	3.086
N° 2 (ON)	3.090	3.088	3.090	3.088	3.087
N° 3 (ON)	3.091	3.089	3.090	3.088	3.088
N° 4 (ON)	3.090	3.089	3.089	3.088	3.086
N° 5 (ON)	3.090	3.089	3.089	3.088	3.088
N° 6 (ON)	3.090	3.088	3.088	3.088	3.086
N° 7 (OFF)	3.092	3.090	3.091	3.090	3.089
N° 8 (OFF)	3.095	3.092	3.093	3.094	3.092
N° 9 (OFF)	3.089	3.087	3.086	3.086	3.086
N° 10 (OFF)	3.090	3.087	3.087	3.087	3.087
N° 11 (OFF)	3.088	3.087	3.087	3.086	3.085

Delta [Voh_IO[8]]

	0krad(Si)	42krad(Si)	78krad(Si)	114krad(Si)	150krad(Si)
N° 1 (Ref)	---	-9.000E-4	3.000E-4	-8.000E-4	-5.000E-4
N° 2 (ON)	---	-2.100E-3	-6.000E-4	-2.100E-3	-3.400E-3
N° 3 (ON)	---	-2.000E-3	-1.500E-3	-3.300E-3	-3.300E-3
N° 4 (ON)	---	-7.000E-4	-1.200E-3	-1.800E-3	-3.800E-3
N° 5 (ON)	---	-1.600E-3	-9.000E-4	-2.200E-3	-2.100E-3
N° 6 (ON)	---	-1.900E-3	-1.900E-3	-2.200E-3	-4.200E-3
N° 7 (OFF)	---	-2.100E-3	-1.600E-3	-2.300E-3	-3.200E-3
N° 8 (OFF)	---	-2.100E-3	-1.500E-3	-6.000E-4	-2.600E-3
N° 9 (OFF)	---	-1.800E-3	-2.300E-3	-2.400E-3	-2.900E-3
N° 10 (OFF)	---	-2.300E-3	-2.200E-3	-2.300E-3	-2.800E-3
N° 11 (OFF)	---	-1.500E-3	-1.800E-3	-2.300E-3	-3.600E-3
Average (ON)	---	-1.660E-3	-1.220E-3	-2.320E-3	-3.360E-3
s (ON)	---	5.683E-4	5.070E-4	5.718E-4	7.893E-4
Average+3s (ON)	---	4.499E-5	3.009E-4	-6.045E-4	-9.921E-4
Average-3s (ON)	---	-3.365E-3	-2.741E-3	-4.036E-3	-5.728E-3
Average (OFF)	---	-1.960E-3	-1.880E-3	-1.980E-3	-3.020E-3
s (OFF)	---	3.130E-4	3.564E-4	7.727E-4	3.899E-4
Average+3s (OFF)	---	-1.021E-3	-8.109E-4	3.380E-4	-1.850E-3
Average-3s (OFF)	---	-2.899E-3	-2.949E-3	-4.298E-3	-4.190E-3

110. Voh_IO[9]

Ta = 25°C, Vcc = 3.3V, Ioh = -4mA

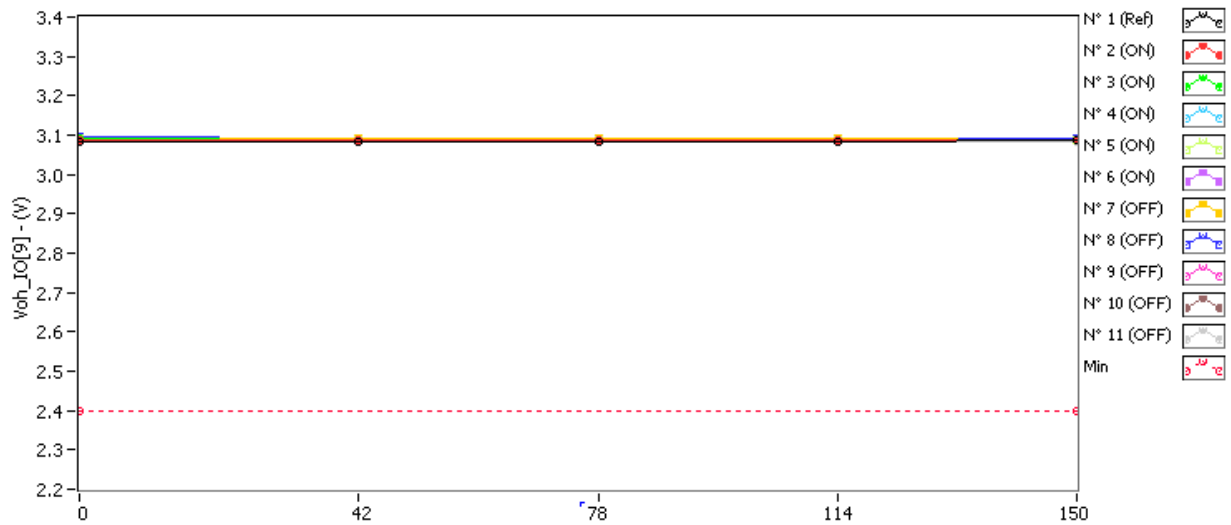

Voh_IO[9] . (V)

Min = 2.4

	0krad(Si)	42krad(Si)	78krad(Si)	114krad(Si)	150krad(Si)
N° 1 (Ref)	3.085	3.085	3.085	3.085	3.086
N° 2 (ON)	3.089	3.088	3.088	3.088	3.088
N° 3 (ON)	3.090	3.089	3.089	3.088	3.088
N° 4 (ON)	3.089	3.088	3.088	3.087	3.086
N° 5 (ON)	3.090	3.088	3.088	3.087	3.087
N° 6 (ON)	3.090	3.087	3.088	3.087	3.086
N° 7 (OFF)	3.092	3.090	3.091	3.090	3.089
N° 8 (OFF)	3.094	3.092	3.091	3.091	3.091
N° 9 (OFF)	3.088	3.086	3.086	3.086	3.086
N° 10 (OFF)	3.088	3.086	3.088	3.087	3.085
N° 11 (OFF)	3.086	3.086	3.086	3.085	3.084

Delta [Voh_IO[9]]

	0krad(Si)	42krad(Si)	78krad(Si)	114krad(Si)	150krad(Si)
N° 1 (Ref)	---	3.000E-4	6.000E-4	6.000E-4	1.400E-3
N° 2 (ON)	---	-1.100E-3	-9.000E-4	-1.400E-3	-1.500E-3
N° 3 (ON)	---	-1.200E-3	-1.300E-3	-1.500E-3	-2.200E-3
N° 4 (ON)	---	-1.000E-3	-1.300E-3	-2.300E-3	-3.800E-3
N° 5 (ON)	---	-1.900E-3	-2.500E-3	-3.300E-3	-3.200E-3
N° 6 (ON)	---	-2.300E-3	-1.200E-3	-2.100E-3	-3.800E-3
N° 7 (OFF)	---	-1.500E-3	-1.200E-3	-2.000E-3	-2.900E-3
N° 8 (OFF)	---	-1.900E-3	-2.300E-3	-2.600E-3	-2.600E-3
N° 9 (OFF)	---	-2.300E-3	-2.400E-3	-2.100E-3	-2.600E-3
N° 10 (OFF)	---	-1.900E-3	-6.000E-4	-1.000E-3	-2.900E-3
N° 11 (OFF)	---	-6.000E-4	-1.000E-4	-1.000E-3	-1.700E-3
Average (ON)	---	-1.500E-3	-1.440E-3	-2.120E-3	-2.900E-3
s (ON)	---	5.701E-4	6.148E-4	7.629E-4	1.020E-3
Average+3s (ON)	---	2.103E-4	4.045E-4	1.687E-4	1.594E-4
Average-3s (ON)	---	-3.210E-3	-3.284E-3	-4.409E-3	-5.959E-3
Average (OFF)	---	-1.640E-3	-1.320E-3	-1.740E-3	-2.540E-3
s (OFF)	---	6.465E-4	1.018E-3	7.127E-4	4.930E-4
Average+3s (OFF)	---	2.996E-4	1.735E-3	3.982E-4	-1.061E-3
Average-3s (OFF)	---	-3.580E-3	-4.375E-3	-3.878E-3	-4.019E-3

111. Voh_IO[10]

Ta = 25°C, Vcc = 3.3V, Ioh = -4mA

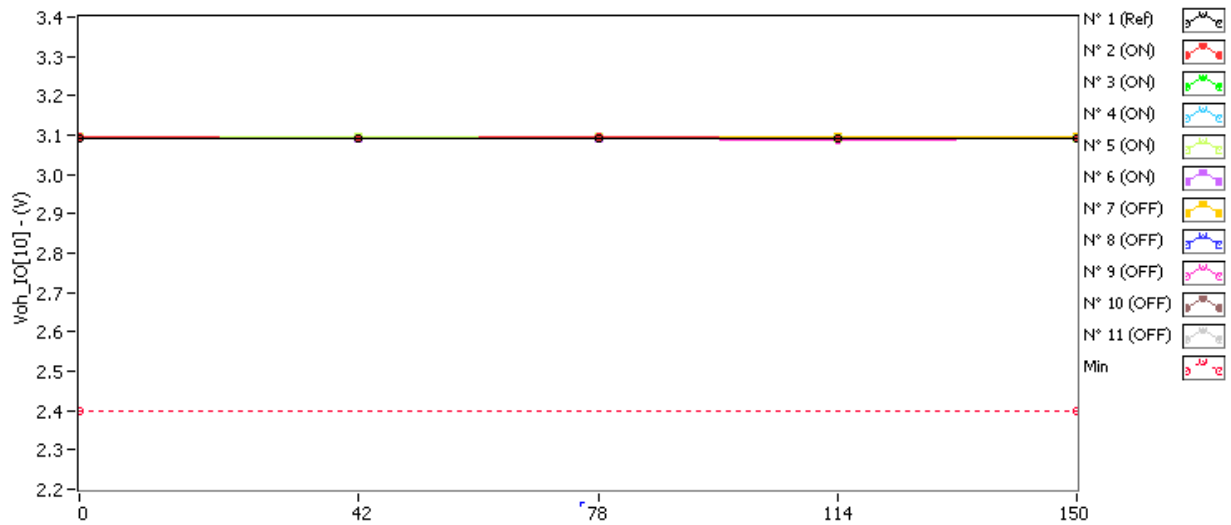

Voh_IO[10] . (V)

Min = 2.4

	0krad(Si)	42krad(Si)	78krad(Si)	114krad(Si)	150krad(Si)
N° 1 (Ref)	3.090	3.091	3.092	3.091	3.092
N° 2 (ON)	3.095	3.093	3.095	3.092	3.093
N° 3 (ON)	3.096	3.093	3.094	3.092	3.093
N° 4 (ON)	3.095	3.093	3.094	3.091	3.091
N° 5 (ON)	3.095	3.094	3.095	3.091	3.093
N° 6 (ON)	3.094	3.093	3.094	3.091	3.093
N° 7 (OFF)	3.097	3.096	3.096	3.095	3.096
N° 8 (OFF)	3.098	3.096	3.096	3.095	3.095
N° 9 (OFF)	3.092	3.090	3.091	3.089	3.091
N° 10 (OFF)	3.092	3.091	3.091	3.090	3.091
N° 11 (OFF)	3.090	3.091	3.091	3.090	3.090

Delta [Voh_IO[10]]

	0krad(Si)	42krad(Si)	78krad(Si)	114krad(Si)	150krad(Si)
N° 1 (Ref)	---	1.500E-3	2.100E-3	1.700E-3	2.100E-3
N° 2 (ON)	---	-1.700E-3	0.000E+0	-2.900E-3	-2.100E-3
N° 3 (ON)	---	-2.800E-3	-2.000E-3	-3.400E-3	-2.200E-3
N° 4 (ON)	---	-1.700E-3	-6.000E-4	-3.200E-3	-3.200E-3
N° 5 (ON)	---	-8.000E-4	1.000E-4	-3.800E-3	-1.900E-3
N° 6 (ON)	---	-1.400E-3	-5.000E-4	-3.100E-3	-8.000E-4
N° 7 (OFF)	---	-1.500E-3	-1.100E-3	-2.900E-3	-1.800E-3
N° 8 (OFF)	---	-1.700E-3	-1.200E-3	-2.300E-3	-2.300E-3
N° 9 (OFF)	---	-1.900E-3	-3.000E-4	-2.800E-3	-1.100E-3
N° 10 (OFF)	---	-6.000E-4	-4.000E-4	-2.300E-3	-1.000E-3
N° 11 (OFF)	---	4.000E-4	6.000E-4	-5.000E-4	3.000E-4
Average (ON)	---	-1.680E-3	-6.000E-4	-3.280E-3	-2.040E-3
s (ON)	---	7.259E-4	8.396E-4	3.421E-4	8.562E-4
Average+3s (ON)	---	4.978E-4	1.919E-3	-2.254E-3	5.285E-4
Average-3s (ON)	---	-3.858E-3	-3.119E-3	-4.306E-3	-4.608E-3
Average (OFF)	---	-1.060E-3	-4.800E-4	-2.160E-3	-1.180E-3
s (OFF)	---	9.555E-4	7.259E-4	9.685E-4	9.834E-4
Average+3s (OFF)	---	1.807E-3	1.698E-3	7.455E-4	1.770E-3
Average-3s (OFF)	---	-3.927E-3	-2.658E-3	-5.066E-3	-4.130E-3

112. Voh_IO[11]

Ta = 25°C, Vcc = 3.3V, Ioh = -4mA

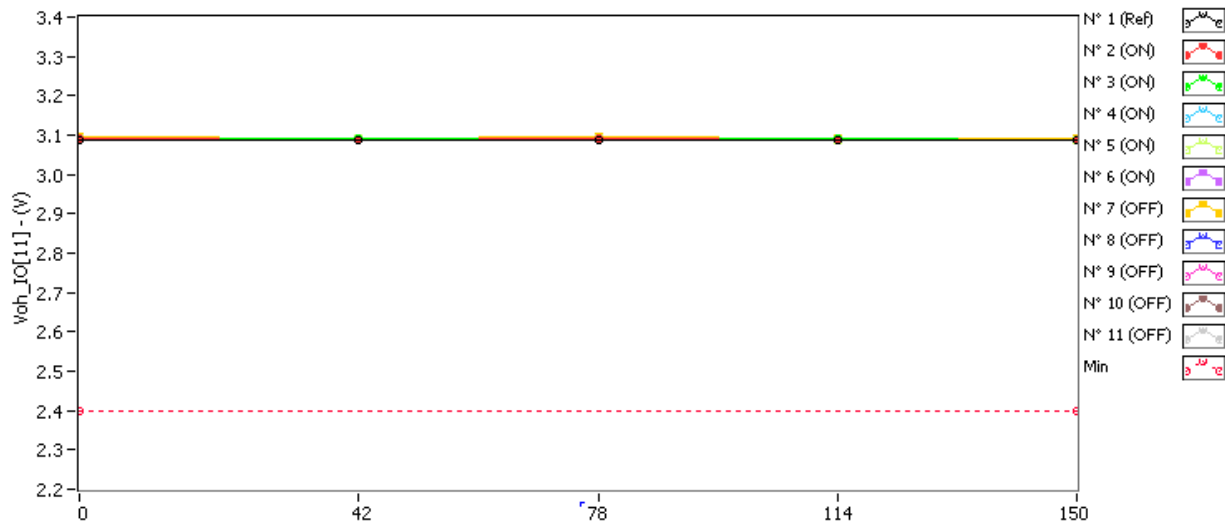

Voh_IO[11] . (V)

Min = 2.4

	0krad(Si)	42krad(Si)	78krad(Si)	114krad(Si)	150krad(Si)
N° 1 (Ref)	3.087	3.087	3.087	3.088	3.087
N° 2 (ON)	3.091	3.088	3.090	3.089	3.088
N° 3 (ON)	3.091	3.090	3.090	3.090	3.088
N° 4 (ON)	3.091	3.089	3.090	3.088	3.087
N° 5 (ON)	3.092	3.090	3.090	3.089	3.088
N° 6 (ON)	3.091	3.090	3.090	3.089	3.088
N° 7 (OFF)	3.095	3.092	3.094	3.092	3.092
N° 8 (OFF)	3.096	3.093	3.094	3.093	3.093
N° 9 (OFF)	3.090	3.088	3.087	3.087	3.086
N° 10 (OFF)	3.090	3.087	3.088	3.088	3.087
N° 11 (OFF)	3.089	3.087	3.087	3.087	3.086

Delta [Voh_IO[11]]

	0krad(Si)	42krad(Si)	78krad(Si)	114krad(Si)	150krad(Si)
N° 1 (Ref)	---	-5.000E-4	-5.000E-4	2.000E-4	-3.000E-4
N° 2 (ON)	---	-2.300E-3	-3.000E-4	-2.100E-3	-2.900E-3
N° 3 (ON)	---	-1.100E-3	-1.400E-3	-1.700E-3	-2.900E-3
N° 4 (ON)	---	-1.900E-3	-1.000E-3	-2.900E-3	-4.200E-3
N° 5 (ON)	---	-2.400E-3	-2.300E-3	-3.300E-3	-4.100E-3
N° 6 (ON)	---	-1.400E-3	-1.100E-3	-2.700E-3	-3.500E-3
N° 7 (OFF)	---	-2.600E-3	-9.000E-4	-2.900E-3	-3.500E-3
N° 8 (OFF)	---	-2.300E-3	-1.600E-3	-2.400E-3	-3.000E-3
N° 9 (OFF)	---	-1.800E-3	-2.600E-3	-2.600E-3	-3.200E-3
N° 10 (OFF)	---	-2.100E-3	-1.200E-3	-1.600E-3	-2.300E-3
N° 11 (OFF)	---	-1.600E-3	-1.100E-3	-1.300E-3	-2.800E-3
Average (ON)	---	-1.820E-3	-1.220E-3	-2.540E-3	-3.520E-3
s (ON)	---	5.630E-4	7.259E-4	6.387E-4	6.261E-4
Average+3s (ON)	---	-1.309E-4	9.578E-4	-6.238E-4	-1.642E-3
Average-3s (ON)	---	-3.509E-3	-3.398E-3	-4.456E-3	-5.398E-3
Average (OFF)	---	-2.080E-3	-1.480E-3	-2.160E-3	-2.960E-3
s (OFF)	---	3.962E-4	6.760E-4	6.804E-4	4.506E-4
Average+3s (OFF)	---	-8.913E-4	5.481E-4	-1.187E-4	-1.608E-3
Average-3s (OFF)	---	-3.269E-3	-3.508E-3	-4.201E-3	-4.312E-3

113. Voh_IO[12]

Ta = 25°C, Vcc = 3.3V, Ioh = -4mA

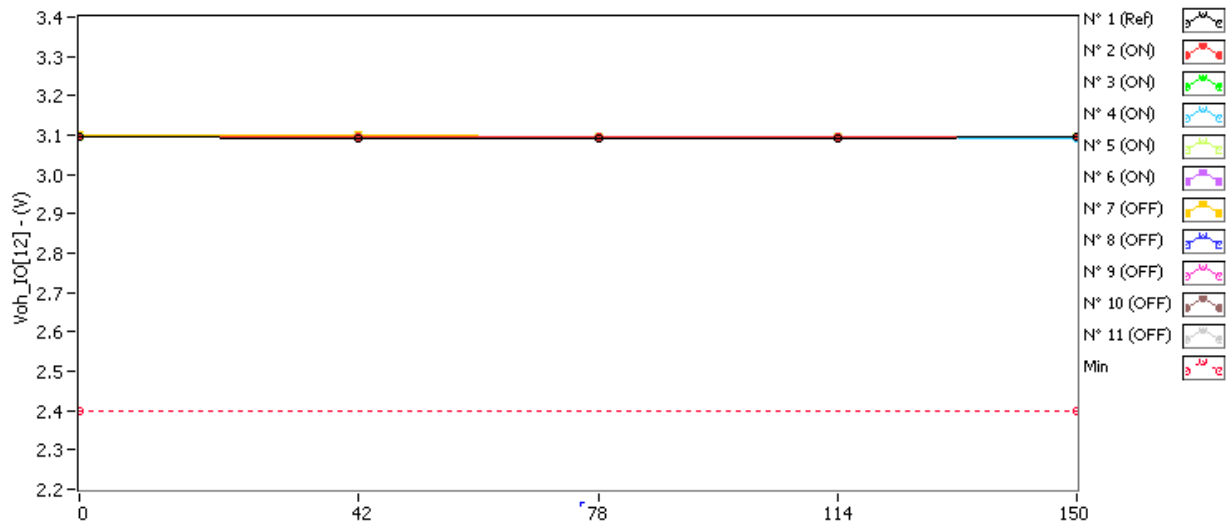

Voh_IO[12] . (V)

Min = 2.4

	0krad(Si)	42krad(Si)	78krad(Si)	114krad(Si)	150krad(Si)
N° 1 (Ref)	3.094	3.093	3.093	3.092	3.094
N° 2 (ON)	3.097	3.095	3.096	3.095	3.094
N° 3 (ON)	3.097	3.095	3.095	3.095	3.095
N° 4 (ON)	3.096	3.093	3.094	3.094	3.093
N° 5 (ON)	3.097	3.095	3.095	3.094	3.094
N° 6 (ON)	3.097	3.096	3.096	3.094	3.095
N° 7 (OFF)	3.100	3.099	3.098	3.097	3.097
N° 8 (OFF)	3.099	3.097	3.097	3.097	3.096
N° 9 (OFF)	3.096	3.094	3.094	3.094	3.094
N° 10 (OFF)	3.096	3.095	3.095	3.094	3.094
N° 11 (OFF)	3.095	3.094	3.093	3.093	3.092

Delta [Voh_IO[12]]

	0krad(Si)	42krad(Si)	78krad(Si)	114krad(Si)	150krad(Si)
N° 1 (Ref)	---	-4.000E-4	-5.000E-4	-1.300E-3	1.000E-4
N° 2 (ON)	---	-1.700E-3	-1.500E-3	-2.100E-3	-3.200E-3
N° 3 (ON)	---	-1.700E-3	-1.700E-3	-1.700E-3	-2.600E-3
N° 4 (ON)	---	-2.900E-3	-2.200E-3	-2.400E-3	-3.600E-3
N° 5 (ON)	---	-1.700E-3	-2.000E-3	-2.700E-3	-3.300E-3
N° 6 (ON)	---	-1.500E-3	-1.800E-3	-3.200E-3	-2.700E-3
N° 7 (OFF)	---	-1.500E-3	-2.400E-3	-2.700E-3	-2.700E-3
N° 8 (OFF)	---	-1.700E-3	-1.200E-3	-1.800E-3	-2.200E-3
N° 9 (OFF)	---	-2.100E-3	-1.500E-3	-2.000E-3	-2.000E-3
N° 10 (OFF)	---	-2.000E-3	-1.200E-3	-2.600E-3	-2.900E-3
N° 11 (OFF)	---	-1.100E-3	-1.600E-3	-2.000E-3	-2.800E-3
Average (ON)	---	-1.900E-3	-1.840E-3	-2.420E-3	-3.080E-3
s (ON)	---	5.657E-4	2.702E-4	5.718E-4	4.207E-4
Average+3s (ON)	---	-2.029E-4	-1.029E-3	-7.045E-4	-1.818E-3
Average-3s (ON)	---	-3.597E-3	-2.651E-3	-4.136E-3	-4.342E-3
Average (OFF)	---	-1.680E-3	-1.580E-3	-2.220E-3	-2.520E-3
s (OFF)	---	4.025E-4	4.919E-4	4.025E-4	3.962E-4
Average+3s (OFF)	---	-4.725E-4	-1.042E-4	-1.013E-3	-1.331E-3
Average-3s (OFF)	---	-2.887E-3	-3.056E-3	-3.427E-3	-3.709E-3

114. Voh_IO[13]

Ta = 25°C, Vcc = 3.3V, Ioh = -4mA

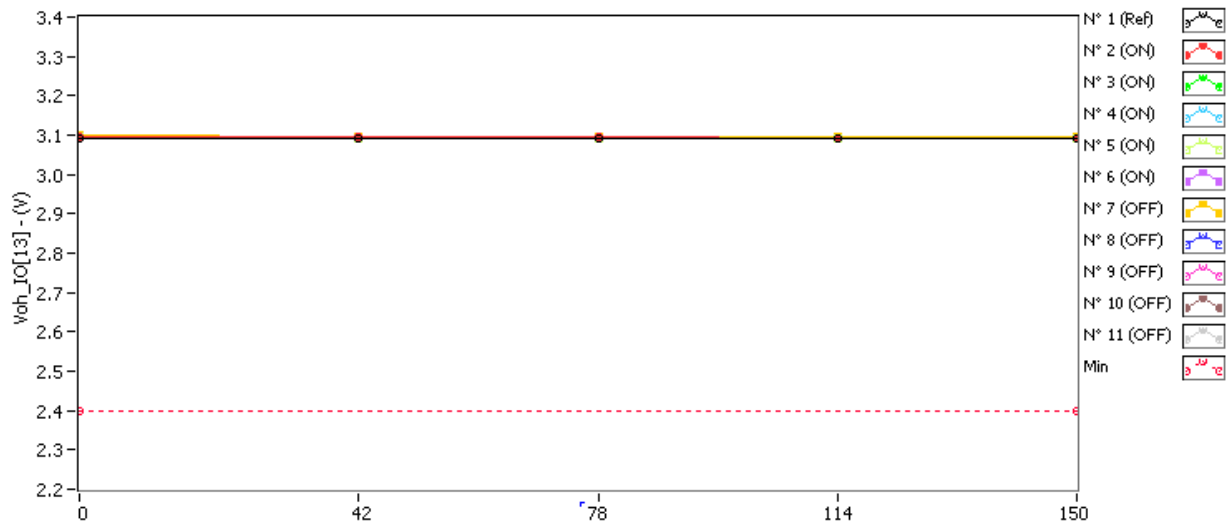

Voh_IO[13] . (V)

Min = 2.4

	0krad(Si)	42krad(Si)	78krad(Si)	114krad(Si)	150krad(Si)
N° 1 (Ref)	3.091	3.092	3.091	3.091	3.092
N° 2 (ON)	3.095	3.094	3.094	3.093	3.091
N° 3 (ON)	3.096	3.094	3.094	3.093	3.093
N° 4 (ON)	3.095	3.093	3.093	3.092	3.091
N° 5 (ON)	3.095	3.092	3.093	3.092	3.092
N° 6 (ON)	3.096	3.093	3.094	3.093	3.092
N° 7 (OFF)	3.099	3.097	3.097	3.096	3.096
N° 8 (OFF)	3.096	3.095	3.096	3.095	3.095
N° 9 (OFF)	3.094	3.093	3.092	3.092	3.091
N° 10 (OFF)	3.095	3.092	3.093	3.092	3.092
N° 11 (OFF)	3.093	3.091	3.092	3.090	3.090

Delta [Voh_IO[13]]

	0krad(Si)	42krad(Si)	78krad(Si)	114krad(Si)	150krad(Si)
N° 1 (Ref)	---	3.000E-4	2.000E-4	-3.000E-4	5.000E-4
N° 2 (ON)	---	-1.500E-3	-9.000E-4	-2.200E-3	-3.800E-3
N° 3 (ON)	---	-1.500E-3	-1.400E-3	-2.300E-3	-2.500E-3
N° 4 (ON)	---	-2.000E-3	-2.100E-3	-2.400E-3	-3.800E-3
N° 5 (ON)	---	-2.900E-3	-2.100E-3	-2.900E-3	-3.800E-3
N° 6 (ON)	---	-2.900E-3	-2.400E-3	-3.000E-3	-3.800E-3
N° 7 (OFF)	---	-2.100E-3	-1.700E-3	-2.800E-3	-3.100E-3
N° 8 (OFF)	---	-1.000E-3	-7.000E-4	-9.000E-4	-1.600E-3
N° 9 (OFF)	---	-1.000E-3	-1.600E-3	-1.900E-3	-2.300E-3
N° 10 (OFF)	---	-2.100E-3	-1.500E-3	-2.100E-3	-2.700E-3
N° 11 (OFF)	---	-1.800E-3	-1.100E-3	-2.900E-3	-3.100E-3
Average (ON)	---	-2.160E-3	-1.780E-3	-2.560E-3	-3.540E-3
s (ON)	---	7.057E-4	6.140E-4	3.647E-4	5.814E-4
Average+3s (ON)	---	-4.293E-5	6.201E-5	-1.466E-3	-1.796E-3
Average-3s (ON)	---	-4.277E-3	-3.622E-3	-3.654E-3	-5.284E-3
Average (OFF)	---	-1.600E-3	-1.320E-3	-2.120E-3	-2.560E-3
s (OFF)	---	5.612E-4	4.147E-4	8.075E-4	6.309E-4
Average+3s (OFF)	---	8.375E-5	-7.581E-5	3.024E-4	-6.674E-4
Average-3s (OFF)	---	-3.284E-3	-2.564E-3	-4.542E-3	-4.453E-3

115. Voh_IO[14]

Ta = 25°C, Vcc = 3.3V, Ioh = -4mA

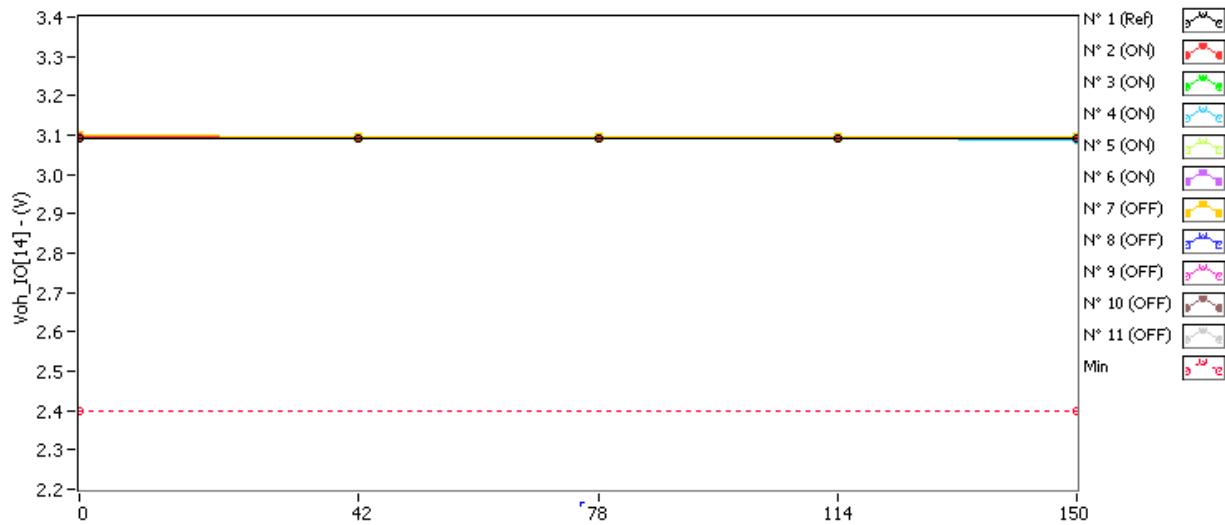

Voh_IO[14] . (V)

Min = 2.4

	0krad(Si)	42krad(Si)	78krad(Si)	114krad(Si)	150krad(Si)
N° 1 (Ref)	3.091	3.090	3.091	3.091	3.091
N° 2 (ON)	3.094	3.092	3.092	3.091	3.091
N° 3 (ON)	3.094	3.092	3.093	3.092	3.092
N° 4 (ON)	3.092	3.091	3.092	3.090	3.089
N° 5 (ON)	3.095	3.093	3.093	3.092	3.092
N° 6 (ON)	3.095	3.093	3.094	3.092	3.092
N° 7 (OFF)	3.098	3.096	3.097	3.096	3.096
N° 8 (OFF)	3.096	3.095	3.095	3.095	3.095
N° 9 (OFF)	3.093	3.091	3.092	3.091	3.090
N° 10 (OFF)	3.093	3.092	3.092	3.091	3.092
N° 11 (OFF)	3.092	3.091	3.090	3.090	3.089

Delta [Voh_IO[14]]

	0krad(Si)	42krad(Si)	78krad(Si)	114krad(Si)	150krad(Si)
N° 1 (Ref)	---	-7.000E-4	-2.000E-4	-4.000E-4	6.000E-4
N° 2 (ON)	---	-1.400E-3	-1.600E-3	-2.300E-3	-2.900E-3
N° 3 (ON)	---	-2.000E-3	-1.400E-3	-1.700E-3	-2.100E-3
N° 4 (ON)	---	-1.500E-3	-7.000E-4	-2.600E-3	-3.800E-3
N° 5 (ON)	---	-2.300E-3	-1.800E-3	-2.600E-3	-3.500E-3
N° 6 (ON)	---	-2.300E-3	-1.500E-3	-2.900E-3	-3.300E-3
N° 7 (OFF)	---	-1.900E-3	-1.200E-3	-1.900E-3	-1.700E-3
N° 8 (OFF)	---	-1.500E-3	-1.100E-3	-2.000E-3	-1.800E-3
N° 9 (OFF)	---	-2.000E-3	-1.400E-3	-2.000E-3	-2.600E-3
N° 10 (OFF)	---	-1.200E-3	-1.300E-3	-1.800E-3	-1.300E-3
N° 11 (OFF)	---	-1.100E-3	-1.200E-3	-1.500E-3	-2.900E-3
Average (ON)	---	-1.900E-3	-1.400E-3	-2.420E-3	-3.120E-3
s (ON)	---	4.301E-4	4.183E-4	4.550E-4	6.573E-4
Average+3s (ON)	---	-6.097E-4	-1.450E-4	-1.055E-3	-1.148E-3
Average-3s (ON)	---	-3.190E-3	-2.655E-3	-3.785E-3	-5.092E-3
Average (OFF)	---	-1.540E-3	-1.240E-3	-1.840E-3	-2.060E-3
s (OFF)	---	4.037E-4	1.140E-4	2.074E-4	6.656E-4
Average+3s (OFF)	---	-3.288E-4	-8.979E-4	-1.218E-3	-6.325E-5
Average-3s (OFF)	---	-2.751E-3	-1.582E-3	-2.462E-3	-4.057E-3

116. Voh_IO[15]

Ta = 25°C, Vcc = 3.3V, Ioh = -4mA

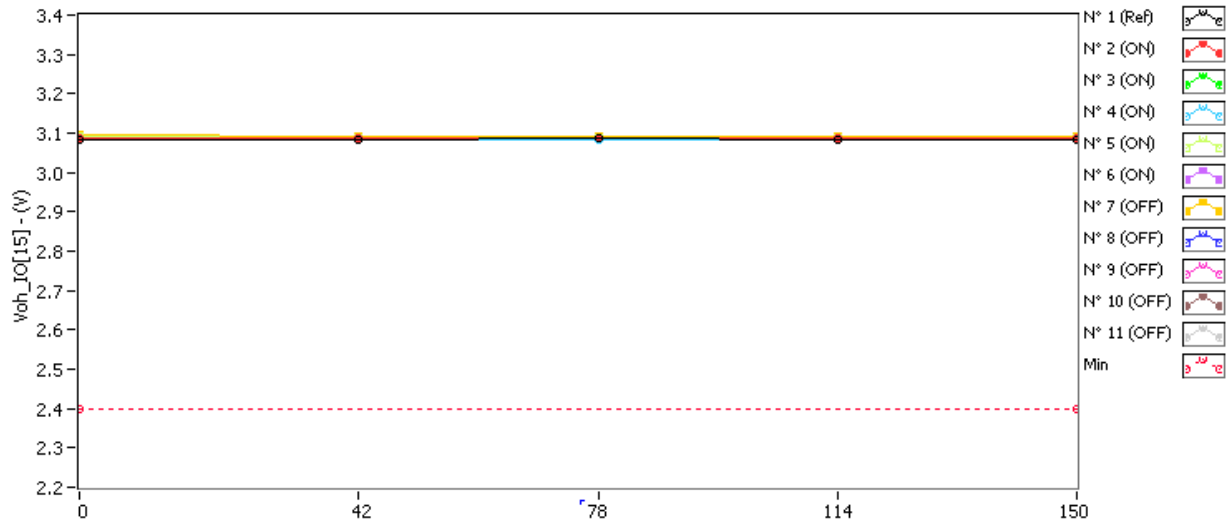

Voh_IO[15] . (V)

Min = 2.4

	0krad(Si)	42krad(Si)	78krad(Si)	114krad(Si)	150krad(Si)
N° 1 (Ref)	3.085	3.085	3.085	3.085	3.085
N° 2 (ON)	3.089	3.086	3.087	3.087	3.086
N° 3 (ON)	3.089	3.087	3.087	3.087	3.087
N° 4 (ON)	3.087	3.085	3.085	3.085	3.084
N° 5 (ON)	3.091	3.088	3.088	3.088	3.087
N° 6 (ON)	3.090	3.088	3.088	3.087	3.087
N° 7 (OFF)	3.094	3.092	3.092	3.091	3.091
N° 8 (OFF)	3.091	3.090	3.090	3.091	3.089
N° 9 (OFF)	3.087	3.086	3.086	3.086	3.085
N° 10 (OFF)	3.088	3.087	3.087	3.086	3.086
N° 11 (OFF)	3.087	3.085	3.086	3.084	3.083

Delta [Voh_IO[15]]

	0krad(Si)	42krad(Si)	78krad(Si)	114krad(Si)	150krad(Si)
N° 1 (Ref)	---	-3.000E-4	2.000E-4	-6.000E-4	-4.000E-4
N° 2 (ON)	---	-2.200E-3	-1.100E-3	-1.900E-3	-2.800E-3
N° 3 (ON)	---	-2.500E-3	-1.700E-3	-1.900E-3	-2.200E-3
N° 4 (ON)	---	-2.100E-3	-2.300E-3	-2.900E-3	-3.700E-3
N° 5 (ON)	---	-2.900E-3	-2.500E-3	-2.600E-3	-4.200E-3
N° 6 (ON)	---	-1.500E-3	-1.800E-3	-3.100E-3	-3.200E-3
N° 7 (OFF)	---	-1.900E-3	-2.000E-3	-3.100E-3	-2.800E-3
N° 8 (OFF)	---	-1.100E-3	-1.100E-3	-2.000E-4	-1.900E-3
N° 9 (OFF)	---	-1.200E-3	-1.400E-3	-1.800E-3	-2.300E-3
N° 10 (OFF)	---	-8.000E-4	-1.400E-3	-2.300E-3	-2.400E-3
N° 11 (OFF)	---	-1.200E-3	-1.100E-3	-2.300E-3	-3.100E-3
Average (ON)	---	-2.240E-3	-1.880E-3	-2.480E-3	-3.220E-3
s (ON)	---	5.177E-4	5.495E-4	5.586E-4	7.759E-4
Average+3s (ON)	---	-6.869E-4	-2.314E-4	-8.043E-4	-8.923E-4
Average-3s (ON)	---	-3.793E-3	-3.529E-3	-4.156E-3	-5.548E-3
Average (OFF)	---	-1.240E-3	-1.400E-3	-1.940E-3	-2.500E-3
s (OFF)	---	4.037E-4	3.674E-4	1.078E-3	4.637E-4
Average+3s (OFF)	---	-2.880E-5	-2.977E-4	1.295E-3	-1.109E-3
Average-3s (OFF)	---	-2.451E-3	-2.502E-3	-5.175E-3	-3.891E-3

117. tAA

Ta = 25°C, Vcc = 3.3V, Vih = 2.0V, Vil = 0.8V

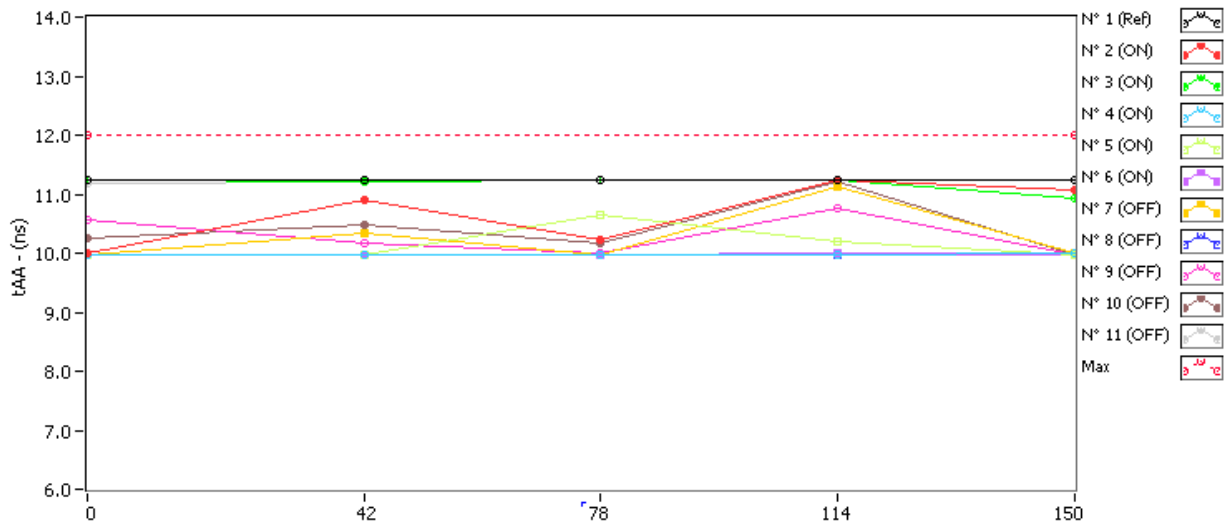

tAA . (ns) Max = 12.0

	0krad(Si)	42krad(Si)	78krad(Si)	114krad(Si)	150krad(Si)
N° 1 (Ref)	11.230	11.230	11.230	11.230	11.230
N° 2 (ON)	10.000	10.898	10.225	11.230	11.074
N° 3 (ON)	11.230	11.221	11.230	11.230	10.938
N° 4 (ON)	9.980	9.980	9.980	9.980	9.990
N° 5 (ON)	9.980	9.980	10.635	10.205	9.980
N° 6 (ON)	9.980	9.980	9.980	9.990	9.980
N° 7 (OFF)	9.980	10.342	9.980	11.133	9.990
N° 8 (OFF)	9.980	9.980	9.980	9.980	9.980
N° 9 (OFF)	10.557	10.156	9.990	10.771	9.980
N° 10 (OFF)	10.264	10.469	10.166	11.201	9.980
N° 11 (OFF)	11.172	11.221	11.230	11.230	11.230

Delta [tAA]

	0krad(Si)	42krad(Si)	78krad(Si)	114krad(Si)	150krad(Si)
N° 1 (Ref)	---	0.000E+0	0.000E+0	0.000E+0	0.000E+0
N° 2 (ON)	---	8.980E-1	2.250E-1	1.230E+0	1.074E+0
N° 3 (ON)	---	-9.000E-3	0.000E+0	0.000E+0	-2.920E-1
N° 4 (ON)	---	0.000E+0	0.000E+0	0.000E+0	9.700E-3
N° 5 (ON)	---	0.000E+0	6.545E-1	2.245E-1	0.000E+0
N° 6 (ON)	---	0.000E+0	0.000E+0	9.700E-3	0.000E+0
N° 7 (OFF)	---	3.615E-1	0.000E+0	1.152E+0	9.700E-3
N° 8 (OFF)	---	0.000E+0	0.000E+0	0.000E+0	0.000E+0
N° 9 (OFF)	---	-4.010E-1	-5.668E-1	2.140E-1	-5.765E-1
N° 10 (OFF)	---	2.050E-1	-9.800E-2	9.370E-1	-2.835E-1
N° 11 (OFF)	---	4.900E-2	5.800E-2	5.800E-2	5.800E-2
Average (ON)	---	1.778E-1	1.759E-1	2.928E-1	1.583E-1
s (ON)	---	4.026E-1	2.847E-1	5.326E-1	5.276E-1
Average+3s (ON)	---	1.386E+0	1.030E+0	1.891E+0	1.741E+0
Average-3s (ON)	---	-1.030E+0	-6.783E-1	-1.305E+0	-1.424E+0
Average (OFF)	---	4.290E-2	-1.214E-1	4.723E-1	-1.585E-1
s (OFF)	---	2.858E-1	2.552E-1	5.339E-1	2.696E-1
Average+3s (OFF)	---	9.003E-1	6.444E-1	2.074E+0	6.502E-1
Average-3s (OFF)	---	-8.145E-1	-8.871E-1	-1.129E+0	-9.671E-1

118. tACS

Ta = 25°C, Vcc = 3.3V, Vih = 2.0V, Vil = 0.8V

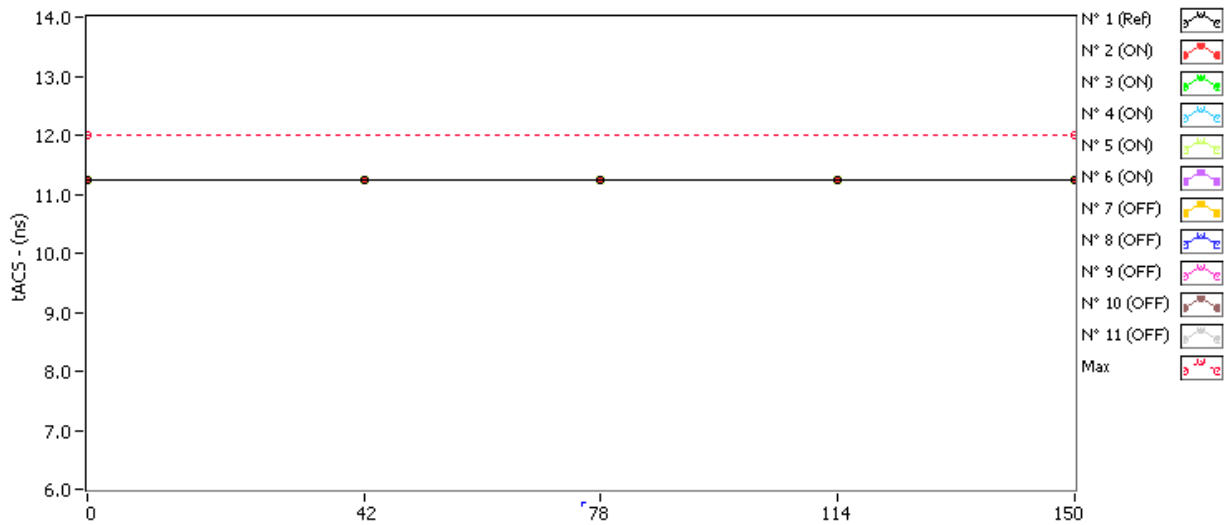

tACS . (ns) Max = 12.0

	0krad(Si)	42krad(Si)	78krad(Si)	114krad(Si)	150krad(Si)
N° 1 (Ref)	11.235	11.235	11.235	11.235	11.235
N° 2 (ON)	11.235	11.235	11.235	11.235	11.235
N° 3 (ON)	11.235	11.235	11.235	11.235	11.235
N° 4 (ON)	11.235	11.235	11.235	11.235	11.235
N° 5 (ON)	11.235	11.235	11.235	11.235	11.235
N° 6 (ON)	11.235	11.235	11.235	11.235	11.235
N° 7 (OFF)	11.235	11.235	11.235	11.235	11.235
N° 8 (OFF)	11.235	11.235	11.235	11.235	11.235
N° 9 (OFF)	11.235	11.235	11.235	11.235	11.235
N° 10 (OFF)	11.235	11.235	11.235	11.235	11.235
N° 11 (OFF)	11.235	11.235	11.235	11.235	11.235

Delta [tACS]

	0krad(Si)	42krad(Si)	78krad(Si)	114krad(Si)	150krad(Si)
N° 1 (Ref)	---	0.000E+0	0.000E+0	0.000E+0	0.000E+0
N° 2 (ON)	---	0.000E+0	0.000E+0	0.000E+0	0.000E+0
N° 3 (ON)	---	0.000E+0	0.000E+0	0.000E+0	0.000E+0
N° 4 (ON)	---	0.000E+0	0.000E+0	0.000E+0	0.000E+0
N° 5 (ON)	---	0.000E+0	0.000E+0	0.000E+0	0.000E+0
N° 6 (ON)	---	0.000E+0	0.000E+0	0.000E+0	0.000E+0
N° 7 (OFF)	---	0.000E+0	0.000E+0	0.000E+0	0.000E+0
N° 8 (OFF)	---	0.000E+0	0.000E+0	0.000E+0	0.000E+0
N° 9 (OFF)	---	0.000E+0	0.000E+0	0.000E+0	0.000E+0
N° 10 (OFF)	---	0.000E+0	0.000E+0	0.000E+0	0.000E+0
N° 11 (OFF)	---	0.000E+0	0.000E+0	0.000E+0	0.000E+0
Average (ON)	---	0.000E+0	0.000E+0	0.000E+0	0.000E+0
s (ON)	---	0.000E+0	0.000E+0	0.000E+0	0.000E+0
Average+3s (ON)	---	0.000E+0	0.000E+0	0.000E+0	0.000E+0
Average-3s (ON)	---	0.000E+0	0.000E+0	0.000E+0	0.000E+0
Average (OFF)	---	0.000E+0	0.000E+0	0.000E+0	0.000E+0
s (OFF)	---	0.000E+0	0.000E+0	0.000E+0	0.000E+0
Average+3s (OFF)	---	0.000E+0	0.000E+0	0.000E+0	0.000E+0
Average-3s (OFF)	---	0.000E+0	0.000E+0	0.000E+0	0.000E+0

119. tOE

Ta = 25°C, Vcc = 3.3V, Vih = 2.0V, Vil = 0.8V

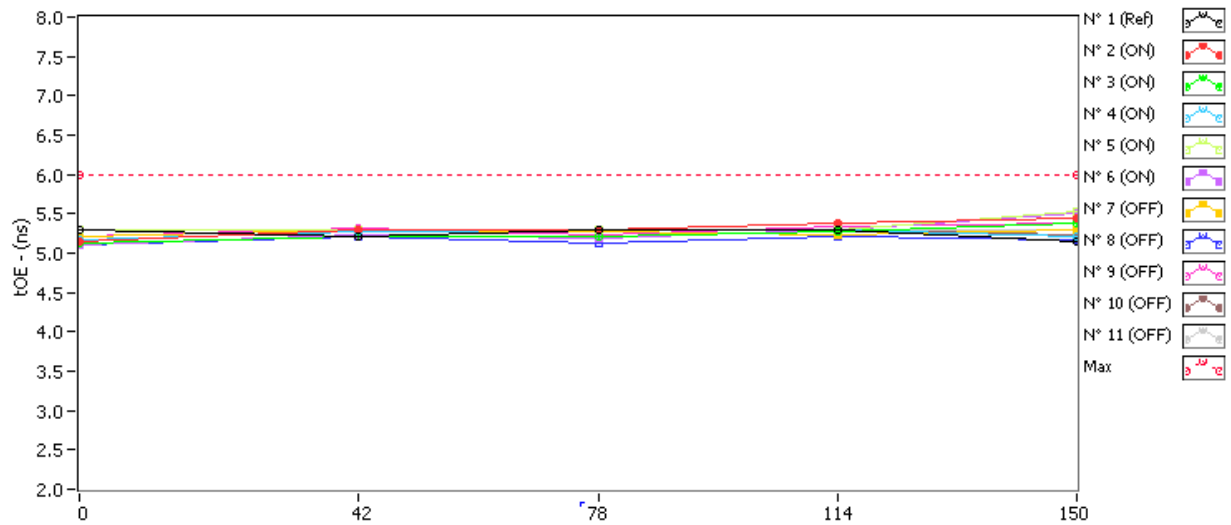

tOE . (ns) Max = 6.0

	0krad(Si)	42krad(Si)	78krad(Si)	114krad(Si)	150krad(Si)
N° 1 (Ref)	5.294	5.217	5.294	5.294	5.149
N° 2 (ON)	5.157	5.294	5.294	5.380	5.448
N° 3 (ON)	5.132	5.217	5.217	5.269	5.371
N° 4 (ON)	5.166	5.269	5.294	5.303	5.217
N° 5 (ON)	5.294	5.294	5.294	5.303	5.525
N° 6 (ON)	5.106	5.226	5.200	5.294	5.516
N° 7 (OFF)	5.217	5.286	5.269	5.234	5.294
N° 8 (OFF)	5.098	5.217	5.132	5.217	5.166
N° 9 (OFF)	5.217	5.320	5.234	5.328	5.371
N° 10 (OFF)	5.217	5.303	5.286	5.294	5.234
N° 11 (OFF)	5.217	5.286	5.294	5.294	5.294

Delta [tOE]

	0krad(Si)	42krad(Si)	78krad(Si)	114krad(Si)	150krad(Si)
N° 1 (Ref)	---	-7.690E-2	0.000E+0	0.000E+0	-1.453E-1
N° 2 (ON)	---	1.367E-1	1.367E-1	2.221E-1	2.905E-1
N° 3 (ON)	---	8.550E-2	8.550E-2	1.368E-1	2.393E-1
N° 4 (ON)	---	1.026E-1	1.282E-1	1.367E-1	5.130E-2
N° 5 (ON)	---	0.000E+0	0.000E+0	8.500E-3	2.307E-1
N° 6 (ON)	---	1.196E-1	9.400E-2	1.880E-1	4.102E-1
N° 7 (OFF)	---	6.830E-2	5.130E-2	1.710E-2	7.690E-2
N° 8 (OFF)	---	1.196E-1	3.410E-2	1.196E-1	6.830E-2
N° 9 (OFF)	---	1.025E-1	1.710E-2	1.111E-1	1.538E-1
N° 10 (OFF)	---	8.540E-2	6.830E-2	7.690E-2	1.710E-2
N° 11 (OFF)	---	6.830E-2	7.690E-2	7.690E-2	7.690E-2
Average (ON)	---	8.888E-2	8.888E-2	1.384E-1	2.444E-1
s (ON)	---	5.322E-2	5.425E-2	8.116E-2	1.295E-1
Average+3s (ON)	---	2.485E-1	2.516E-1	3.819E-1	6.330E-1
Average-3s (ON)	---	-7.078E-2	-7.386E-2	-1.050E-1	-1.442E-1
Average (OFF)	---	8.882E-2	4.954E-2	8.032E-2	7.860E-2
s (OFF)	---	2.230E-2	2.447E-2	4.034E-2	4.886E-2
Average+3s (OFF)	---	1.557E-1	1.229E-1	2.014E-1	2.252E-1
Average-3s (OFF)	---	2.193E-2	-2.386E-2	-4.071E-2	-6.798E-2

120. Func_0_Vcc_Min

Ta = 25°C, Vcc = 3V, Vih = 2.0V, Vil = 0.8V, Functional test, Write zeros - Read zeros - Full memory

Func_0_Vcc_Min . (-)

	0krad(Si)	42krad(Si)	78krad(Si)	114krad(Si)	150krad(Si)
N° 1 (Ref)	PASS	PASS	PASS	PASS	PASS
N° 2 (ON)	PASS	PASS	PASS	PASS	PASS
N° 3 (ON)	PASS	PASS	PASS	PASS	PASS
N° 4 (ON)	PASS	PASS	PASS	PASS	PASS
N° 5 (ON)	PASS	PASS	PASS	PASS	PASS
N° 6 (ON)	PASS	PASS	PASS	PASS	PASS
N° 7 (OFF)	PASS	PASS	PASS	PASS	PASS
N° 8 (OFF)	PASS	PASS	PASS	PASS	PASS
N° 9 (OFF)	PASS	PASS	PASS	PASS	PASS
N° 10 (OFF)	PASS	PASS	PASS	PASS	PASS
N° 11 (OFF)	PASS	PASS	PASS	PASS	PASS

121. Func_0_Vcc_Nom

Ta = 25°C, Vcc = 3.3V, Vih = 2.0V, Vil = 0.8V, Functional test, Write zeros - Read zeros - Full memory

Func_0_Vcc_Nom . (-)

	0krad(Si)	42krad(Si)	78krad(Si)	114krad(Si)	150krad(Si)
N° 1 (Ref)	PASS	PASS	PASS	PASS	PASS
N° 2 (ON)	PASS	PASS	PASS	PASS	PASS
N° 3 (ON)	PASS	PASS	PASS	PASS	PASS
N° 4 (ON)	PASS	PASS	PASS	PASS	PASS
N° 5 (ON)	PASS	PASS	PASS	PASS	PASS
N° 6 (ON)	PASS	PASS	PASS	PASS	PASS
N° 7 (OFF)	PASS	PASS	PASS	PASS	PASS
N° 8 (OFF)	PASS	PASS	PASS	PASS	PASS
N° 9 (OFF)	PASS	PASS	PASS	PASS	PASS
N° 10 (OFF)	PASS	PASS	PASS	PASS	PASS
N° 11 (OFF)	PASS	PASS	PASS	PASS	PASS

122. Func_0_Vcc_Max

Ta = 25°C, Vcc = 3.6V, Vih = 2.0V, Vil = 0.8V, Functional test, Write zeros - Read zeros - Full memory

Func_0_Vcc_Max . (-)

	0krad(Si)	42krad(Si)	78krad(Si)	114krad(Si)	150krad(Si)
N° 1 (Ref)	PASS	PASS	PASS	PASS	PASS
N° 2 (ON)	PASS	PASS	PASS	PASS	PASS
N° 3 (ON)	PASS	PASS	PASS	PASS	PASS
N° 4 (ON)	PASS	PASS	PASS	PASS	PASS
N° 5 (ON)	PASS	PASS	PASS	PASS	PASS
N° 6 (ON)	PASS	PASS	PASS	PASS	PASS
N° 7 (OFF)	PASS	PASS	PASS	PASS	PASS
N° 8 (OFF)	PASS	PASS	PASS	PASS	PASS
N° 9 (OFF)	PASS	PASS	PASS	PASS	PASS
N° 10 (OFF)	PASS	PASS	PASS	PASS	PASS
N° 11 (OFF)	PASS	PASS	PASS	PASS	PASS

123. Func_1_Vcc_Min

Ta = 25°C, Vcc = 3V, Vih = 2.0V, Vil = 0.8V, Functional test, Write ones - Read ones - Full memory

Func_1_Vcc_Min . (-)

	0krad(Si)	42krad(Si)	78krad(Si)	114krad(Si)	150krad(Si)
N° 1 (Ref)	PASS	PASS	PASS	PASS	PASS
N° 2 (ON)	PASS	PASS	PASS	PASS	PASS
N° 3 (ON)	PASS	PASS	PASS	PASS	PASS
N° 4 (ON)	PASS	PASS	PASS	PASS	PASS
N° 5 (ON)	PASS	PASS	PASS	PASS	PASS
N° 6 (ON)	PASS	PASS	PASS	PASS	PASS
N° 7 (OFF)	PASS	PASS	PASS	PASS	PASS
N° 8 (OFF)	PASS	PASS	PASS	PASS	PASS
N° 9 (OFF)	PASS	PASS	PASS	PASS	PASS
N° 10 (OFF)	PASS	PASS	PASS	PASS	PASS
N° 11 (OFF)	PASS	PASS	PASS	PASS	PASS

124. Func_1_Vcc_Nom

Ta = 25°C, Vcc = 3.3V, Vih = 2.0V, Vil = 0.8V, Functional test, Write ones - Read ones - Full memory

Func_1_Vcc_Nom . (-)

	0krad(Si)	42krad(Si)	78krad(Si)	114krad(Si)	150krad(Si)
N° 1 (Ref)	PASS	PASS	PASS	PASS	PASS
N° 2 (ON)	PASS	PASS	PASS	PASS	PASS
N° 3 (ON)	PASS	PASS	PASS	PASS	PASS
N° 4 (ON)	PASS	PASS	PASS	PASS	PASS
N° 5 (ON)	PASS	PASS	PASS	PASS	PASS
N° 6 (ON)	PASS	PASS	PASS	PASS	PASS
N° 7 (OFF)	PASS	PASS	PASS	PASS	PASS
N° 8 (OFF)	PASS	PASS	PASS	PASS	PASS
N° 9 (OFF)	PASS	PASS	PASS	PASS	PASS
N° 10 (OFF)	PASS	PASS	PASS	PASS	PASS
N° 11 (OFF)	PASS	PASS	PASS	PASS	PASS

125. Func_1_Vcc_Max

Ta = 25°C, Vcc = 3.6V, Vih = 2.0V, Vil = 0.8V, Functional test, Write ones - Read ones - Full memory

Func_1_Vcc_Max . (-)

	0krad(Si)	42krad(Si)	78krad(Si)	114krad(Si)	150krad(Si)
N° 1 (Ref)	PASS	PASS	PASS	PASS	PASS
N° 2 (ON)	PASS	PASS	PASS	PASS	PASS
N° 3 (ON)	PASS	PASS	PASS	PASS	PASS
N° 4 (ON)	PASS	PASS	PASS	PASS	PASS
N° 5 (ON)	PASS	PASS	PASS	PASS	PASS
N° 6 (ON)	PASS	PASS	PASS	PASS	PASS
N° 7 (OFF)	PASS	PASS	PASS	PASS	PASS
N° 8 (OFF)	PASS	PASS	PASS	PASS	PASS
N° 9 (OFF)	PASS	PASS	PASS	PASS	PASS
N° 10 (OFF)	PASS	PASS	PASS	PASS	PASS
N° 11 (OFF)	PASS	PASS	PASS	PASS	PASS

126. Vdr

Ta = 25°C, Vcc = 3.3V, Vih = 2.0V, Vil = 0.8V

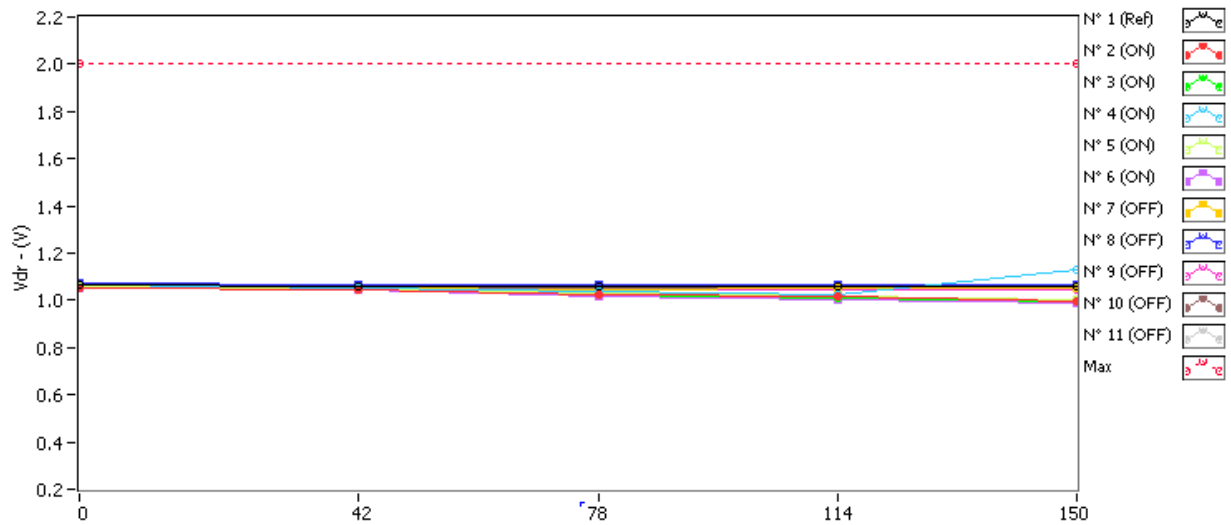

Vdr . (V)

Max = 2.0

	0krad(Si)	42krad(Si)	78krad(Si)	114krad(Si)	150krad(Si)
N° 1 (Ref)	1.063	1.060	1.059	1.061	1.059
N° 2 (ON)	1.055	1.045	1.022	1.019	0.995
N° 3 (ON)	1.052	1.043	1.022	1.010	0.999
N° 4 (ON)	1.067	1.055	1.037	1.023	1.128
N° 5 (ON)	1.062	1.053	1.033	1.014	1.002
N° 6 (ON)	1.055	1.044	1.019	1.001	0.989
N° 7 (OFF)	1.058	1.055	1.048	1.049	1.049
N° 8 (OFF)	1.074	1.069	1.065	1.064	1.063
N° 9 (OFF)	1.057	1.053	1.047	1.046	1.044
N° 10 (OFF)	1.064	1.057	1.054	1.052	1.053
N° 11 (OFF)	1.053	1.048	1.043	1.042	1.042

Delta [Vdr]

	0krad(Si)	42krad(Si)	78krad(Si)	114krad(Si)	150krad(Si)
N° 1 (Ref)	---	-3.000E-3	-4.000E-3	-2.000E-3	-4.000E-3
N° 2 (ON)	---	-PASSE-2	-3.300E-2	-3.600E-2	-6.000E-2
N° 3 (ON)	---	-9.000E-3	-3.000E-2	-4.200E-2	-5.300E-2
N° 4 (ON)	---	-1.200E-2	-3.000E-2	-4.400E-2	6.100E-2
N° 5 (ON)	---	-9.000E-3	-2.900E-2	-4.800E-2	-6.000E-2
N° 6 (ON)	---	-1.100E-2	-3.600E-2	-5.400E-2	-6.600E-2
N° 7 (OFF)	---	-3.000E-3	-PASSE-2	-9.000E-3	-9.000E-3
N° 8 (OFF)	---	-5.000E-3	-9.000E-3	-PASSE-2	-1.100E-2
N° 9 (OFF)	---	-4.000E-3	-PASSE-2	-1.100E-2	-1.300E-2
N° 10 (OFF)	---	-7.000E-3	-PASSE-2	-1.200E-2	-1.100E-2
N° 11 (OFF)	---	-5.000E-3	-PASSE-2	-1.100E-2	-1.100E-2
Average (ON)	---	-1.020E-2	-3.160E-2	-4.480E-2	-3.560E-2
s (ON)	---	1.304E-3	2.881E-3	6.723E-3	5.420E-2
Average+3s (ON)	---	-6.288E-3	-2.296E-2	-2.463E-2	1.270E-1
Average-3s (ON)	---	-1.411E-2	-4.024E-2	-6.497E-2	-1.982E-1
Average (OFF)	---	-4.800E-3	-9.800E-3	-1.060E-2	-1.100E-2
s (OFF)	---	1.483E-3	4.472E-4	1.140E-3	1.414E-3
Average+3s (OFF)	---	-3.503E-4	-8.458E-3	-7.179E-3	-6.757E-3
Average-3s (OFF)	---	-9.250E-3	-1.114E-2	-1.402E-2	-1.524E-2