

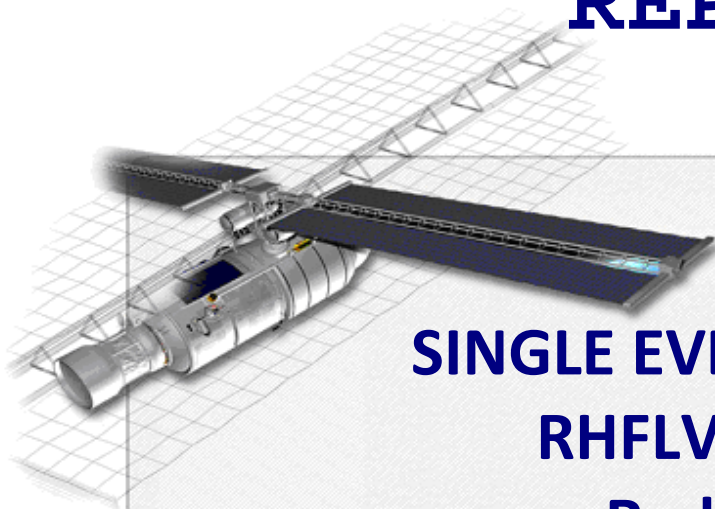

HEAVY IONS TEST REPORT

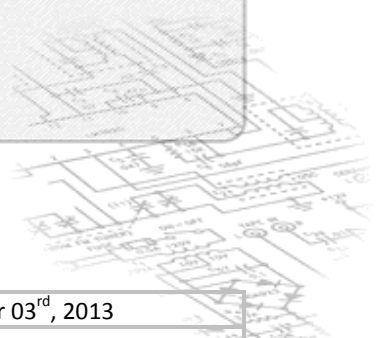

SINGLE EVENT EFFECTS RHFLVDS228A Rad-Hard Dual 4x4 Crosspoint Switch LVDS From ST Microelectronics



TRAD/TI/RHFLVDS228A/XXX1/STM/LS/1307		Labège, September 03 rd , 2013	
 		TRAD, Bât Gallium 907, Voie l'Occitane - 31670 LABEGE France ☎: 05 61 00 95 60 Fax: 05 61 00 95 61 Email: trad@trad.fr Web Site: www.trad.fr SIRET 397 862 038 00056 - TVA FR59397862038	
Written by	Verified by / Quality control	Approved by	
L. SALVY 15/10/2013	L. GOUYET 17/10/2013	Y. PADIÉ 18/10/2013	
Revision: 0			
To:	ST Microelectronics Mrs CHAUMONT Géraldine	Project/Program:	Ref:

CONTENTS

1.	Introduction.....	4
2.	Documents	4
2.1.	Applicable documents	4
3.	Organization of Activities	4
4.	Parts information	5
4.1.	Device description.....	5
4.2.	Identification.....	5
4.3.	Procurement information	5
4.4.	Sample Preparation	5
4.5.	Sample pictures.....	6
4.5.1.	External view	6
4.5.2.	Internal view	6
5.	Dosimetry and Irradiation Facilities	7
5.1.	UCL Heavy Ion Test Facility (Université Catholique de Louvain - Belgique)	7
5.2.	Dosimetry.....	7
5.3.	Beam characteristics.....	8
6.	Test Procedure and Setup	9
6.1.	Test procedure	9
6.1.1.	Description of the test method	9
6.1.2.	SEL Test Principle	9
6.1.3.	SET Test Principle.....	10
6.2.	Test bench description.....	11
6.2.1.	Preparation of test hardware and program	11
6.2.2.	Test equipment identification	11
6.2.3.	Test Bench description	12
6.2.4.	Device setup and Test conditions.....	12
7.	Non conformance.....	13
8.	RESULTS.....	14
8.1.	Runs' summary.	14
8.2.	SEL test results.....	16
8.3.	SET tests results	16
8.3.1.	SET Cross sections.....	16
8.3.2.	Worst Cases SET Observed	18
9.	Conclusion	19
10.	Appendix 1 UCL beam calibration sheets	20

FIGURES

Figure 1: Package marking (Top View)	6
Figure 2: Internal overall view	6
Figure 3: Die marking.....	6
Figure 4 : Common SEL characteristic.....	9
Figure 5: Output signal monitoring in High level configuration.....	10
Figure 6: Output signal monitoring in Low level configuration.....	10
Figure 7: Test system description	12
Figure 8: Test board schematic.....	13
Figure 9: High level SET cross section curve for RHFLVDS228A.....	17
Figure 10: Low level SET cross section curve for RHFLVDS228A.....	17
Figure 11: SET curve, Heavy Ion ¹²⁴ Xe ²⁶⁺ tilted 60° (LET of 135.4 MeV.mg/cm ²), Part 1, Run n°31, Event n°1.....	18
Figure 12: SET curve, Heavy Ion ¹²⁴ Xe ²⁶⁺ tilted 60° (LET of 135.4 MeV.mg/cm ²), Part 3, Run n°33, Event n°1.....	18

TABLES

Table 1: Organization of activities.....	4
Table 2 : UCL cocktail M/Q=5.....	8
Table 3 : UCL cocktail M/Q=3.3.....	8
Table 4: High level SET detection threshold.....	12
Table 5: Low level SET detection threshold.....	12
Table 6: SEL detection threshold.....	12
Table 7: RHFLVDS228A first campaign test results.....	14
Table 8: RHFLVDS228A second campaign test results.....	15
Table 9: RHFLVDS228A High Level SET cross section results.....	16
Table 10: RHFLVDS228A Low Level SET cross section results.....	16

1. Introduction

This report includes the test results of the heavy ions Single Event Effects (SEEs) test sequence carried out on the RHFLVDS228A, a Rad-Hard Dual 4x4 Crosspoint Switch LVDS from ST Microelectronics.

This test was performed for ST Microelectronics on the RHFLVDS228A susceptible to show Single Event Latch-ups (SEs) and Single Event Transients (SETs) induced by heavy ions.

2. Documents

2.1. Applicable documents

Technical Proposal: TRAD/P/STM/4xLVDS/ER/310513 Rev.1

SEE Test Plan: RNS/GC/13-141-02 ce Rev2 of 11/06/2013.

Mail from Mr Croisat, dated august 2nd, 2013, subject "RE: [SEE] RHFLVDS R2D2 - RHFLVDS228A".

Mail from Mrs Rousseau, dated september 10th, 2013, subject "Fwd: Manip IOL semaine 35. LVDS".

3. Organization of Activities

The relevant company has performed the following tasks during this evaluation:

1	Procurement of Test Samples	STM
2	Preparation of Test Samples (delidding)	STM
3	Preparation of Test Hardware and Test Program	TRAD
4	Samples Check out	TRAD
5	Accelerator Test	TRAD
6	Heavy Ion Test Report	TRAD

Table 1: Organization of activities

4. Parts information

4.1. Device description

The LVDS-MUX8 is 8-channel 4x4 crosspoint switch base on Low Voltage Differential Signaling (LVDS) for low power and high speed communications. The two 4x4 MUX allows connection of any of the four inputs to any of the four outputs.

4.2. Identification

Type:	RHFLVDS228A
Manufacturer:	ST Microelectronics
Function:	Rad-Hard Dual 4x4 Crosspoint Switch LVDS

4.3. Procurement information

Packaging:	FP-64
Sample size:	6 parts provided by STMicroelectronics.

4.4. Sample Preparation

All parts were delidded by ST Microelectronics.

A functional test sequence was performed on delidded samples. It appears that 1 part provided by STMicroelectronics was non-functional.

4.5. Sample pictures

4.5.1. External view

No marking at the bottom of the package was observed.



Figure 1: Package marking (Top View)

4.5.2. Internal view

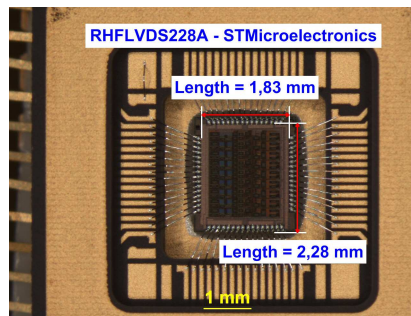

Figure 2: Internal overall view

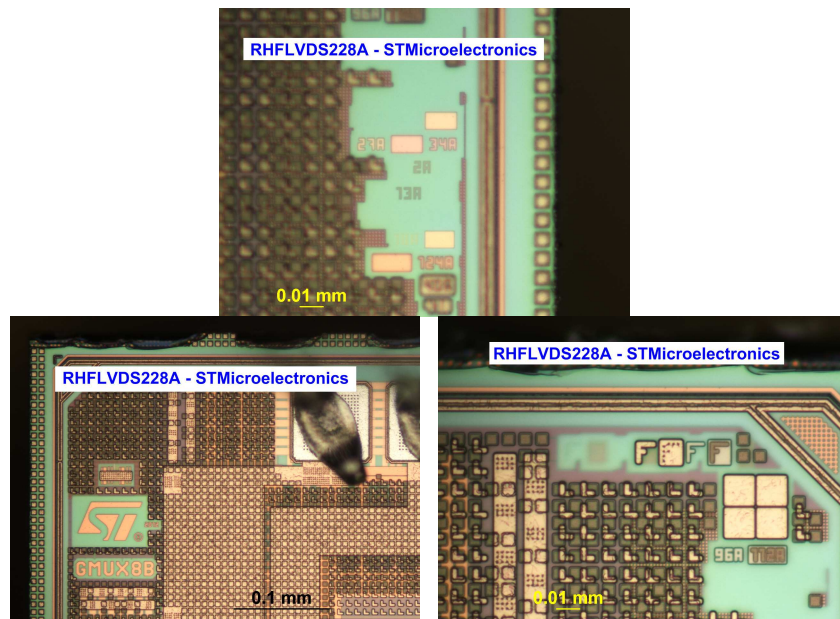

Figure 3: Die marking

5. Dosimetry and Irradiation Facilities

The test was performed at U.C.L (Université Catholique de Louvain) on August 26th and 30th and on October 07th and 08th, 2013. 4 delidded samples were irradiated.

5.1. UCL Heavy Ion Test Facility (Université Catholique de Louvain - Belgique)

The CYCotron of LOuvain la NEuve (CYCLONE) is a multi-particle, variable energy, cyclotron capable of accelerating protons (up to 85 MeV), alpha particles and heavy ions.

For heavy ions, the covered LET range is between 1.2 MeV.cm².mg⁻¹ and 67.7 MeV.cm².mg⁻¹. Heavy ions available are separated in two "Ion Cocktails" named M/Q=5 and M/Q=3.3.

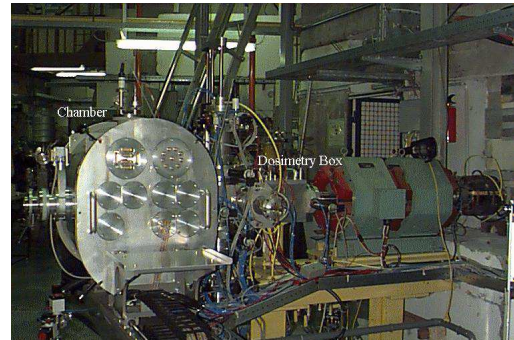

One of the main advantages of the UCL Heavy Ion Test Facility is the fast changing of ion species. Within the same cocktail, it takes only a few minutes to change from one ion to another.

The chamber has the shape of a barrel stretched vertically; its internal dimensions are 71 cm in height, 54 cm in width and 76 cm in depth. One side flange is used to support the board frame (25 X 25 cm) and user connectors.

The chamber is equipped with a vacuum system.

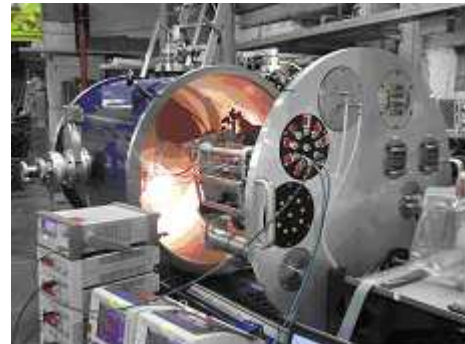

5.2. Dosimetry

To control and monitor the beam parameters, a dosimetry box is placed in front of the chamber. It contains a faraday cup, 2 Parallel Plate Avalanche Counters (PPAC).

Two additional surface barrier detectors are placed in the test chamber.

The faraday cup is used during beam preparation at high intensity.

A beam uniformity measurement is performed with a collimated surface barrier detector. This detector is placed on a X and Y movement. The final profile is drawn and the $\pm 10\%$ width is calculated. The Homogeneity is $\pm 10\%$ on a 25 mm diameter.

During the irradiation, the flux is integrated in order to give the delivered total fluence (particule.cm⁻²) on the device.

5.3. Beam characteristics

The beam flux is variable between a few particles $s^{-1}cm^{-2}$ and $1.8 \cdot 10^4 s^{-1}cm^{-2}$ depending on the device sensitivity.

Heavy ion characteristics are listed in the following tables:

Ion	Energie (MeV)	Range ($\mu m(Si)$)	LET ($MeV \cdot cm^2 \cdot mg^{-1}$)
$^{15}N^{3+}$	60	59	3.3
$^{20}Ne^{4+}$	78	45	6.4
$^{40}Ar^{8+}$	151	40	15.9
$^{84}Kr^{17+}$	305	39	40.4
$^{124}Xe^{25+}$	420	37	67.7

Table 2 : UCL cocktail M/Q=5

Ion	Energie (MeV)	Range ($\mu m(Si)$)	LET ($MeV \cdot cm^2 \cdot mg^{-1}$)
$^{13}C^{4+}$	131	292	1.1
$^{22}Ne^{7+}$	235	216	3
$^{40}Ar^{12+}$	372	117	10.2
$^{58}Ni^{18+}$	567	100	20.4
$^{83}Kr^{25+}$	756	92	32.6

Table 3 : UCL cocktail M/Q=3.3

The highlighted ion species in the table above were used to perform this SEE test.

6. Test Procedure and Setup

6.1. Test procedure

6.1.1. Description of the test method

The test was divided in two parts, with respect to reference or applicable documents:

- Runs were performed up to a fluence of 1.10^7 cm^{-2} with only SEL monitoring. This configuration allowed us to verify the latchup sensitivity of the device.
- Runs were performed up to a fluence of 1.10^7 cm^{-2} for the SET detection. A latchup monitoring was used during these tests in order to protect the component. This configuration allowed us to verify the SET sensitivity.

The test was terminated when the maximum fluence was reached or when we got about a hundred events.

6.1.2. SEL Test Principle

The test was performed at maximum operating voltage and temperature.

TRAD has developed a fully integrated test bench to perform Single Event Latchup tests (SEL). The GUARD system (Graphical Universal Autorange Delatcher) allows the user to easily protect his device under test and perform SEL characterization.

The power supply is applied to the device under test through the GUARD system.

The threshold current of the GUARD system is set according to the nominal current. If the nominal current exceeds the threshold current, the GUARD system is triggered and the event is counted as an SEL. Then, the GUARD system sends a trigger command to the oscilloscope, maintains the power supply during a defined 'Time hold' and cut off during a defined 'Time cut'. Then, the power supply is restarted with the nominal current expected consumption.

At the end of each run, the test program reads the oscilloscope's "Local Scope Counter" which represents the total event count and downloads the records currents waveforms to store them.

Figure 4 shows an example of the SEL detection.

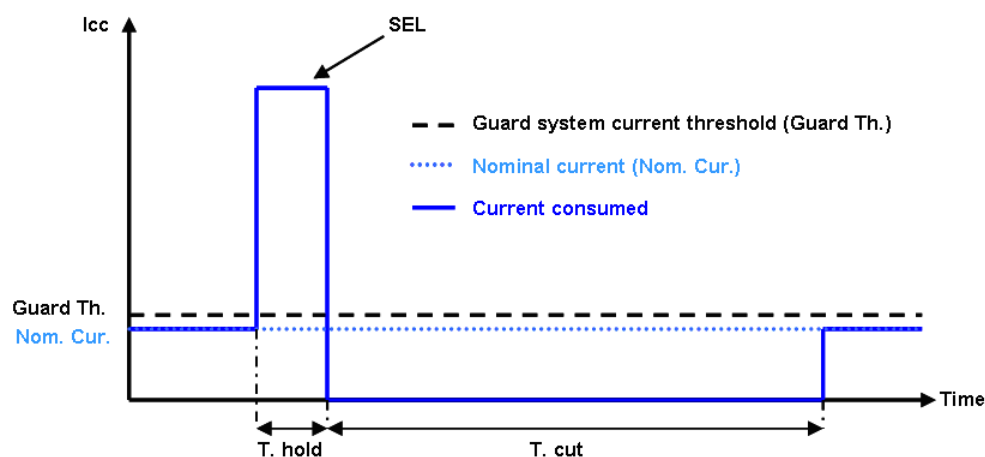

Figure 4 : Common SEL characteristic.

6.1.3. SET Test Principle

The GUARD system is always used on the component's power supply to detect SEL and to prevent the destruction of the device under test.

Single Event Transient is an event described by a voltage amplitude and a timing parameter.

To detect these events, the component's output voltage is monitored.

Two configurations were tested:

- High level out of range:

Pulse width modifications are detected. If the high level time (T_H) is not comprised between T_H min threshold and T_H max threshold, an increment of the oscilloscope internal counter occurs and the trace is stored.

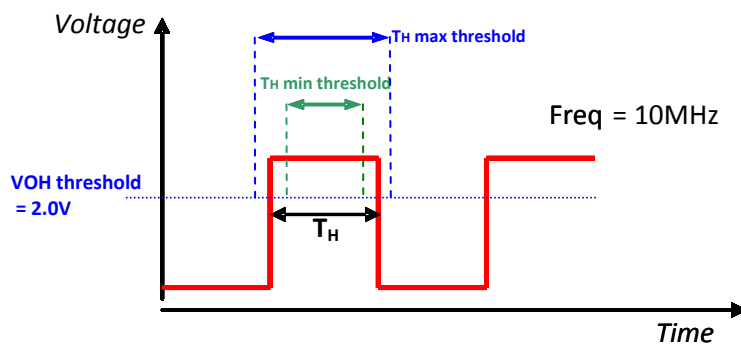

Figure 5: Output signal monitoring in High level configuration.

- Low level out of range:

Same as the High level configuration except we monitor the low level time.

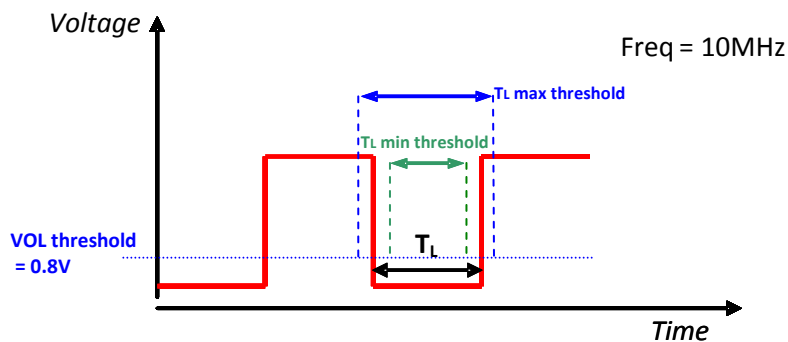

Figure 6: Output signal monitoring in Low level configuration.

At the end of each run, the test program reads the oscilloscope's "Local Scope Counter" which represents the total event count and downloads the records currents waveforms to store them.

6.2. Test bench description

6.2.1. Preparation of test hardware and program

TRAD has developed a specific test program and a specific motherboard to feed power supply to components.

The different outputs of the DUT are visualized using two oscilloscopes and curves are saved when an event occurs.

The test system is driven by a personal computer through a standard IEEE488 communication interface. All signals are delivered and monitored by this equipment and SEE curves are saved in its memory.

At the end of each test run, data is transferred to the hard disk for storage. An overall description of the test system is given in Figure 7.

6.2.2. Test equipment identification

The tests were carried out with evaluation test boards developed by TRAD.

COMPUTER	PO-TE-096
REF. TEST BOARD	TRAD/CT1/I/RHFLVDS228A/FP64/LS/1307 TRAD/CT2/I/RHFLVDS228A/FP64/LS/1307 TRAD/CT3/I/RHFLVDS228A/FP64/LS/1307 TRAD/CT4/I/RHFLVDS228A/FP64/LS/1307
EQUIPMENT	MI-52; MI-60; ME-44; ME-71; ME-79
TEST PROGRAM	RHFLVDS228A_TI_XXX1_BI_V10

6.2.3. Test Bench description

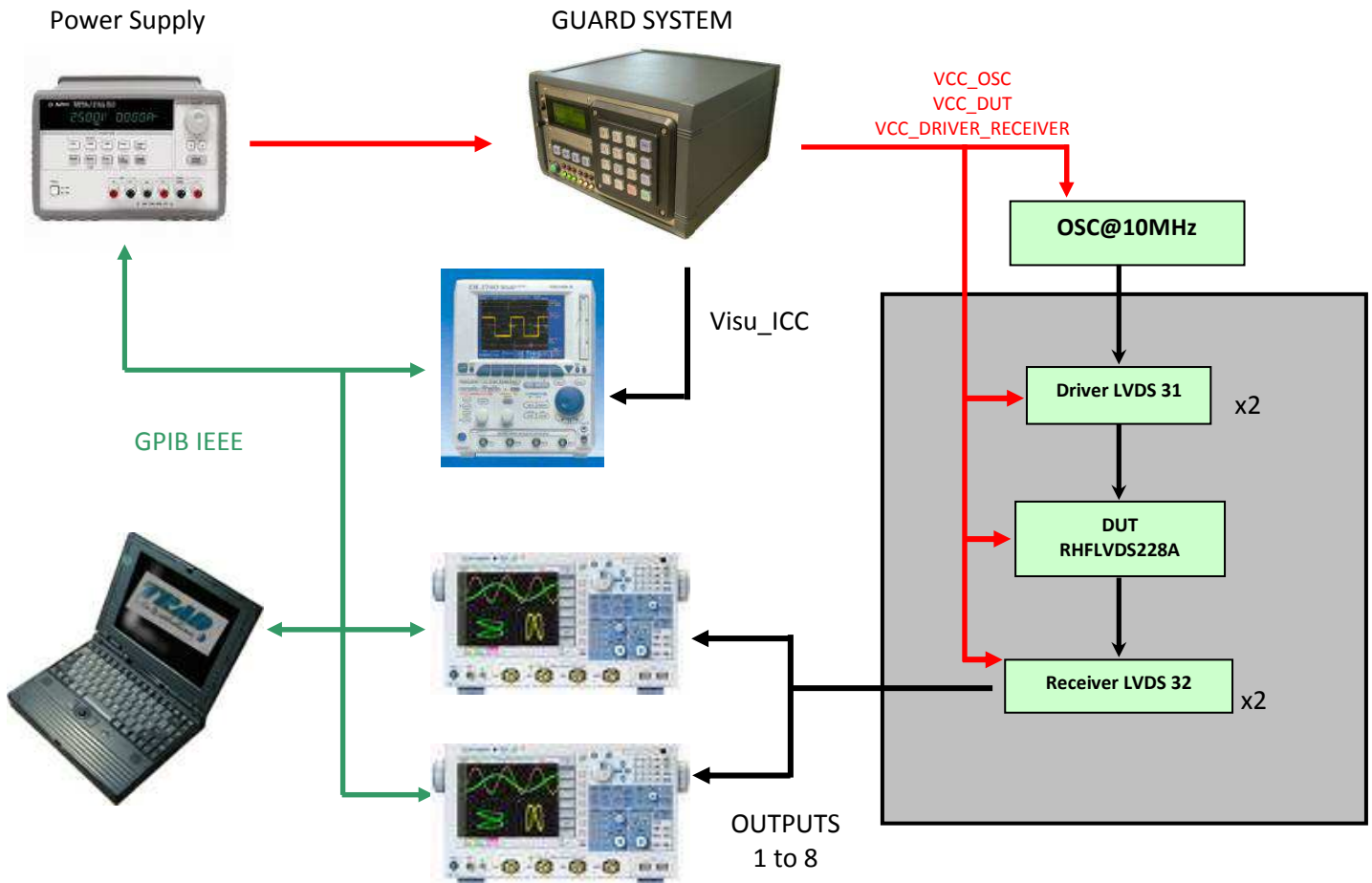

Figure 7: Test system description

6.2.4. Device setup and Test conditions

Trigger thresholds for SET test are defined in the following table:

Vcc	3.3V
VOH Threshold	2.0V
T _H max threshold	49ns
T _H min threshold	51ns
Temperature	25°C

Table 4: High level SET detection threshold

Vcc	3.3V
VOH Threshold	0.8V
T _L max threshold	50ns
T _L min threshold	52ns
Temperature	25°C

Table 5: Low level SET detection threshold

Trigger threshold for SEL test is defined in the following table:

Vcc	3.6V
I _{nominal}	70mA
I _{threshold}	140mA
T _{hold}	1ms
T _{cut}	7ms
Temperature	125°C

Table 6: SEL detection threshold

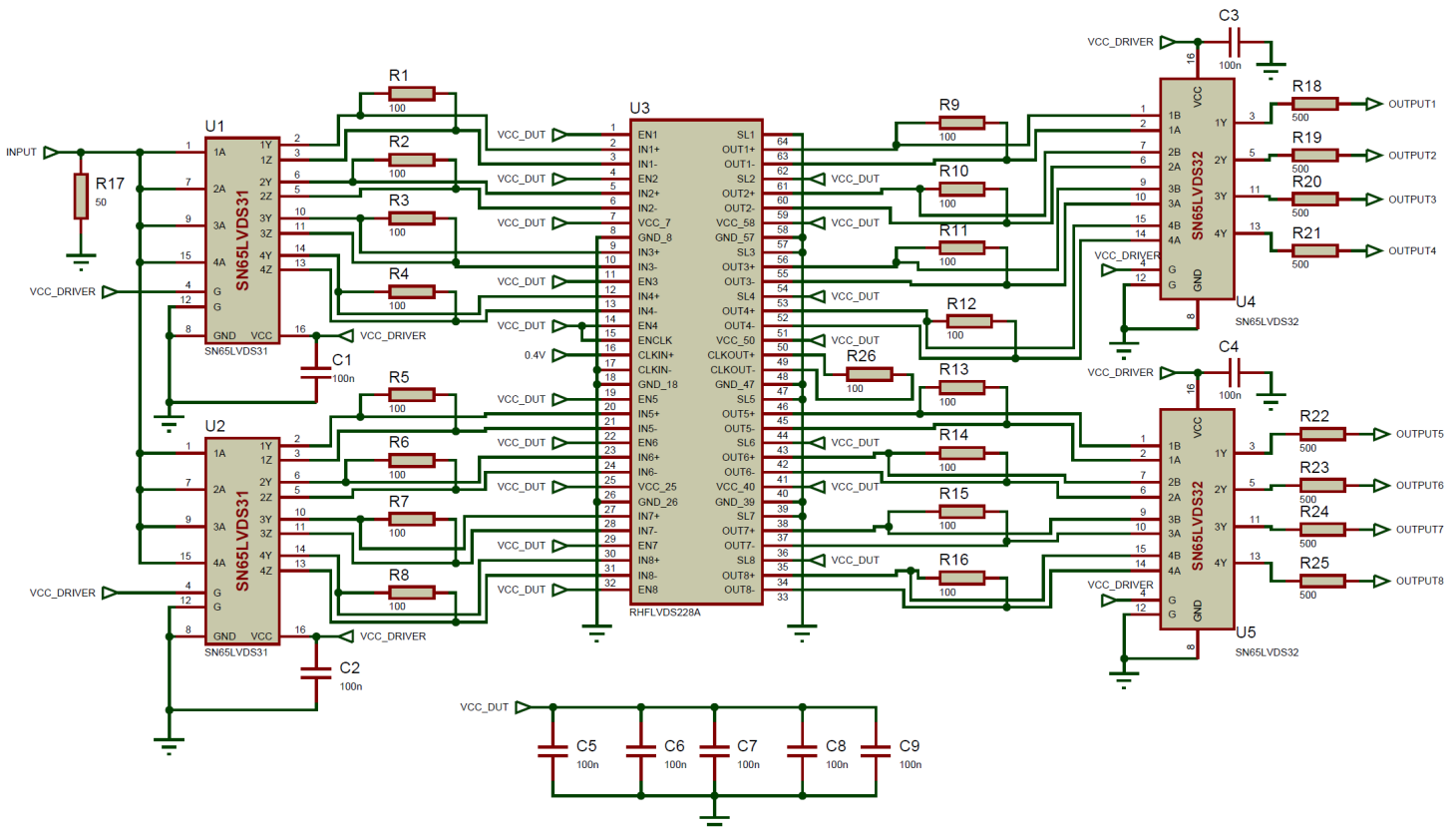

Figure 8: Test board schematic

7. Non conformance

A Non conformance NC_20131016_LS_1 was created.

Non conformance description:

At the beginning of the first test campaign one of the two SET visualization oscilloscope broke down. Without this equipment, all the required SET runs couldn't be done in time during the first test campaign.

In accordance to the mail received from Mrs E. Rousseau dated September 10, 2013, a second test campaign was scheduled in order to get the remaining SET runs. During this second campaign, test sequence, test and measurement conditions were nominal.

8. RESULTS

8.1. Runs' summary.

Hereafter you will find the Runs performed during this campaign.

RHFLVDS228A SEL: VCC = 3.6V / T° = 125°C SET: VDD = 3.3V / T° = 25°C																LATCHUP		SET	
Run	Part	Config	T°	Ion	Energy (MeV)	Range (µm)	LET (MeV.cm ² /m.g)	Tilt (°)	Eff. LET (MeV.cm ² /m.g)	Eff. Range (µm Si)	Flux (φ) (cm ⁻² .s ⁻¹)	Time (s)	Run Fluence (Φ) (cm ⁻²)	Run Dose (krad)	Cumulated Dose (krad)	Vcc	Cross Section	Out_1	Cross Section
High LET M/Q=5																			
1	1	SEL	125	124Xe 26+	420	37	67.7	0	67.70	37.0	9.37E+03	1069	1.00E+07	10.854	10.854	0	<1.00E-07	-	-
2	2	SEL	125	124Xe 26+	420	37	67.7	0	67.70	37.0	1.07E+04	939	1.00E+07	10.851	10.851	0	<1.00E-07	-	-
3	3	SEL	125	124Xe 26+	420	37	67.7	0	67.70	37.0	1.30E+04	772	1.00E+07	10.857	10.857	0	<1.00E-07	-	-
4	4	SEL	125	124Xe 26+	420	37	67.7	0	67.70	37.0	1.40E+04	713	1.00E+07	10.848	10.848	0	<1.00E-07	-	-
5	4	SEL	125	124Xe 26+	420	37	67.7	60	135.40	18.5	8.72E+03	1148	1.00E+07	21.696	32.545	0	<1.00E-07	-	-
6	3	SEL	125	124Xe 26+	420	37	67.7	60	135.40	18.5	7.57E+03	1323	1.00E+07	21.686	32.544	0	<1.00E-07	-	-
7	2	SEL	125	124Xe 26+	420	37	67.7	60	135.40	18.5	7.53E+03	1330	1.00E+07	21.683	32.534	0	<1.00E-07	-	-
8	1	SEL	125	124Xe 26+	420	37	67.7	60	135.40	18.5	7.56E+03	1325	1.00E+07	21.691	32.545	0	<1.00E-07	-	-
9	2	SET 1H	25	124Xe 26+	420	37	67.7	0	67.70	37.0	1.51E+04	662	1.00E+07	10.853	43.387	0	<1.00E-07	0	<1.00E-07
High Range M/Q=3.3																			
10	1	SET 1H	25	83 Kr 25+	756	92	32.6	0	32.60	92.0	7.82E+03	1282	1.00E+07	5.227	37.771	0	<1.00E-07	1	1.00E-07
11	1	SET 1L	25	83 Kr 25+	756	92	32.6	0	32.60	92.0	8.14E+03	1230	1.00E+07	5.225	42.997	0	<1.00E-07	1	1.00E-07
12	2	SET 1H	25	83 Kr 25+	756	92	32.6	0	32.60	92.0	9.94E+03	1008	1.00E+07	5.228	48.616	0	<1.00E-07	0	<1.00E-07
13	2	SET 1L	25	83 Kr 25+	756	92	32.6	0	32.60	92.0	1.10E+04	912	1.00E+07	5.224	53.840	0	<1.00E-07	0	<1.00E-07
14	3	SET 1H	25	83 Kr 25+	756	92	32.6	0	32.60	92.0	1.08E+04	924	1.00E+07	5.228	37.771	0	<1.00E-07	0	<1.00E-07
15	3	SET 1L	25	83 Kr 25+	756	92	32.6	0	32.60	92.0	1.12E+04	891	1.00E+07	5.226	42.997	0	<1.00E-07	0	<1.00E-07
16	4	SET 1H	25	83 Kr 25+	756	92	32.6	0	32.60	92.0	1.09E+04	917	1.00E+07	5.223	37.768	0	<1.00E-07	0	<1.00E-07
17	4	SET 1L	25	83 Kr 25+	756	92	32.6	0	32.60	92.0	1.15E+04	874	1.00E+07	5.223	42.991	0	<1.00E-07	0	<1.00E-07
18	1	SET 1H	25	58 Ni 18+	567	100	20.4	0	20.40	100.0	1.13E+04	886	1.00E+07	3.271	46.267	0	<1.00E-07	0	<1.00E-07
19	1	SET 1L	25	58 Ni 18+	567	100	20.4	0	20.40	100.0	1.18E+04	846	1.00E+07	3.268	49.536	0	<1.00E-07	0	<1.00E-07

Table 7: RHFLVDS228A first campaign test results

RHFLVDS228A SET: VCC = 3.3V / T° = 25°C														LATCHUP		SET																											
Run	Part	Config	T°	Ion	Energy (MeV)	Range (µm)	LET (MeV.cm ² /mg)	Tilt (°)	Eff. LET (MeV.cm ² /mg)	Eff. Range (µm Si)	Flux (φ) (cm ⁻² .s ⁻¹)	Time (s)	Run Fluence (Φ) (cm ⁻²)	Run Dose (krad)	Cumulated Dose (krad)	Vcc	Cross Section	Out_1	Cross Section	Out_2	Cross Section	Out_3	Cross Section	Out_4	Cross Section	Out_5	Cross Section	Out_6	Cross Section	Out_7	Cross Section	Out_8	Cross Section										
High LET M/Q=5																																											
20	1	SET 1H 5L	25	124Xe 26+	420	37	67.7	0	67.70	37.0	1.50E+04	670	1.00E+07	10.853	60.389	0	<1.00E-07	1	1.00E-07	-	-	-	-	-	-	0	<9.98E-08	-	-	-	-	-	-	-	-	-							
21	1	SET 1L 5H	25	124Xe 26+	420	37	67.7	0	67.70	37.0	1.53E+04	654	1.00E+07	10.865	71.254	0	<1.00E-07	1	1.00E-07	-	-	-	-	-	-	0	<9.97E-08	-	-	-	-	-	-	-	-	-							
22	1	SET 2H 6L	25	124Xe 26+	420	37	67.7	0	67.70	37.0	1.53E+04	654	1.00E+07	10.849	82.103	0	<1.00E-07	-	-	0	<1.00E-07	-	-	-	-	-	0	<1.00E-07	-	-	-	-	-	-	-	-							
23	1	SET 2L 6H	25	124Xe 26+	420	37	67.7	0	67.70	37.0	1.53E+04	654	1.00E+07	10.859	92.962	0	<1.00E-07	-	-	1	1.00E-07	-	-	-	-	-	0	<1.00E-07	-	-	-	-	-	-	-	-							
24	1	SET 3H 7L	25	124Xe 26+	420	37	67.7	0	67.70	37.0	1.53E+04	655	1.00E+07	10.854	103.815	0	<1.00E-07	-	-	-	-	2	2.00E-07	-	-	-	-	-	-	-	-	-	-	-	-	-							
25	1	SET 3L 7H	25	124Xe 26+	420	37	67.7	0	67.70	37.0	1.56E+04	644	1.00E+07	10.851	114.667	0	<1.00E-07	-	-	-	-	0	<1.00E-07	-	-	-	-	-	-	-	-	-	-	-	-	-	-						
26	1	SET 4H 8L	25	124Xe 26+	420	37	67.7	0	67.70	37.0	1.54E+04	650	1.00E+07	10.858	125.525	0	<1.00E-07	-	-	-	-	-	-	0	<1.00E-07	-	-	-	-	-	-	-	-	-	-	-	-	-	-				
27	1	SET 4L 8H	25	124Xe 26+	420	37	67.7	0	67.70	37.0	1.55E+04	646	1.00E+07	10.856	136.381	0	<1.00E-07	-	-	-	-	-	-	0	<1.00E-07	-	-	-	-	-	-	-	-	-	-	-	-	-	-	-	-		
28	2	SET 1H 5L	25	124Xe 26+	420	37	67.7	0	67.70	37.0	1.54E+04	651	1.00E+07	10.871	64.711	0	<1.00E-07	0	<1.00E-07	-	-	-	-	-	-	-	197*	1.95E-05*	-	-	-	-	-	-	-	-	-	-	-	-	-		
29	3	SET 1H 5L	25	124Xe 26+	420	37	67.7	0	67.70	37.0	1.53E+04	653	1.00E+07	10.855	53.852	0	<1.00E-07	0	<1.00E-07	-	-	-	-	-	-	-	0	<1.00E-07	-	-	-	-	-	-	-	-	-	-	-	-	-	-	
30	4	SET 1H 5L	25	124Xe 26+	420	37	67.7	0	67.70	37.0	1.52E+04	657	1.00E+07	10.850	53.841	0	<1.00E-07	0	<1.00E-07	-	-	-	-	-	-	-	0	<1.00E-07	-	-	-	-	-	-	-	-	-	-	-	-	-	-	
31	1	SET 1H 5L	25	124Xe 26+	420	37	67.7	60	135.40	18.5	7.69E+03	1302	1.00E+07	21.685	158.067	0	<1.00E-07	2	2.00E-07	-	-	-	-	-	-	1	1.00E-07	-	-	-	-	-	-	-	-	-	-	-	-	-	-		
32	2	SET 1H 5L	25	124Xe 26+	420	37	67.7	60	135.40	18.5	7.74E+03	1294	1.00E+07	21.692	86.403	0	<1.00E-07	0	<1.00E-07	-	-	-	-	-	-	0	<1.00E-07	-	-	-	-	-	-	-	-	-	-	-	-	-	-	-	
33	3	SET 1H 5L	25	124Xe 26+	420	37	67.7	60	135.40	18.5	7.62E+03	1313	1.00E+07	21.685	75.537	0	<1.00E-07	3	3.00E-07	-	-	-	-	-	-	0	<1.00E-07	-	-	-	-	-	-	-	-	-	-	-	-	-	-	-	
34	4	SET 1H 5L	25	124Xe 26+	420	37	67.7	60	135.40	18.5	7.75E+03	1292	1.00E+07	21.682	75.523	0	<1.00E-07	0	<1.00E-07	-	-	-	-	-	-	2	2.00E-07	-	-	-	-	-	-	-	-	-	-	-	-	-	-	-	-
35	2	SET 1H 5L	25	124Xe 26+	420	37	67.7	0	67.70	37.0	1.60E+04	64	1.03E+06	1.111	87.514	0	<1.00E-06	0	<1.00E-06	-	-	-	-	-	-	0	<1.00E-06	-	-	-	-	-	-	-	-	-	-	-	-	-	-	-	-

Table 8: RHFLVDS228A second campaign test results

*: During run n°28 an unusual high number of events happened on output 5. On tilted Xe run n°32, no events were observed. Therefore, we made an additional run, run n°35, up to a fluence of 1.10⁶ to check this behaviour. On this run we did not observe any events, it implies that the cross section is lower than 1.10⁶ and that the result of run 28 is not valid. This behaviour may be due to a bad connection of the DUT on the PCB test board.

No SEL events were detected during this test.

SET events were detected during this test.

SET and SEL tests results are described hereafter.

8.2. SEL test results.

The SEL test was performed at 125°C.

No SEL was observed during this test under Xenon irradiation with a total fluence equal to $1E+7 \text{ cm}^{-2}$:

- with a particle angle of 60° (LET = 135.4 MeV.cm²/mg and range = 18.5µm).
- with a particle angle of 0° (LET = 67.7 MeV.cm²/mg and range = 37µm).

8.3. SET tests results

The SET test was performed at 25°C, two configurations were tested on the DUT outputs.

SETs were observed during the irradiation until the Nickel Heavy Ion (LET = 20.4 MeV.cm²/mg).

8.3.1. SET Cross sections.

LET Eff (MeV.cm ² .mg ⁻¹)	RHFLVDS228A High Level SET Cross Section (cm ²)			
	N° 1	N° 2	N°3	N° 4
135.4	2.0E-07	<1.0E-07	3.0E-07	<1.0E-07
67.7	2.0E-07	<1.0E-07	<1.0E-07	<1.0E-07
32.6	1.0E-07	<1.0E-07	<1.0E-07	<1.0E-07
20.4	<1.0E-07	-	-	-

Table 9: RHFLVDS228A High Level SET cross section results

LET Eff (MeV.cm ² .mg ⁻¹)	RHFLVDS228A Low Level SET Cross Section (cm ²)			
	N° 1	N° 2	N°3	N° 4
135.4	1.0E-07	<1.0E-07	<1.0E-07	2.0E-07
67.7	1.0E-07	<1.0E-06*	<1.0E-07	<1.0E-07
32.6	1.0E-07	<1.0E-07	<1.0E-07	<1.0E-07
20.4	<1.0E-07	-	-	-

Table 10: RHFLVDS228A Low Level SET cross section results

*: Explanations p15.

The following figures present the cross section of the SET event on the outputs of the RHFLVDS228A part.

Points represented by an arrow pointing down indicate that no event was observed at the corresponding LET.

The evaluated cross section is then lower than $1.00 \cdot 10^{-7} \text{ cm}^{-2}$, value corresponding to one event at maximum fluence.

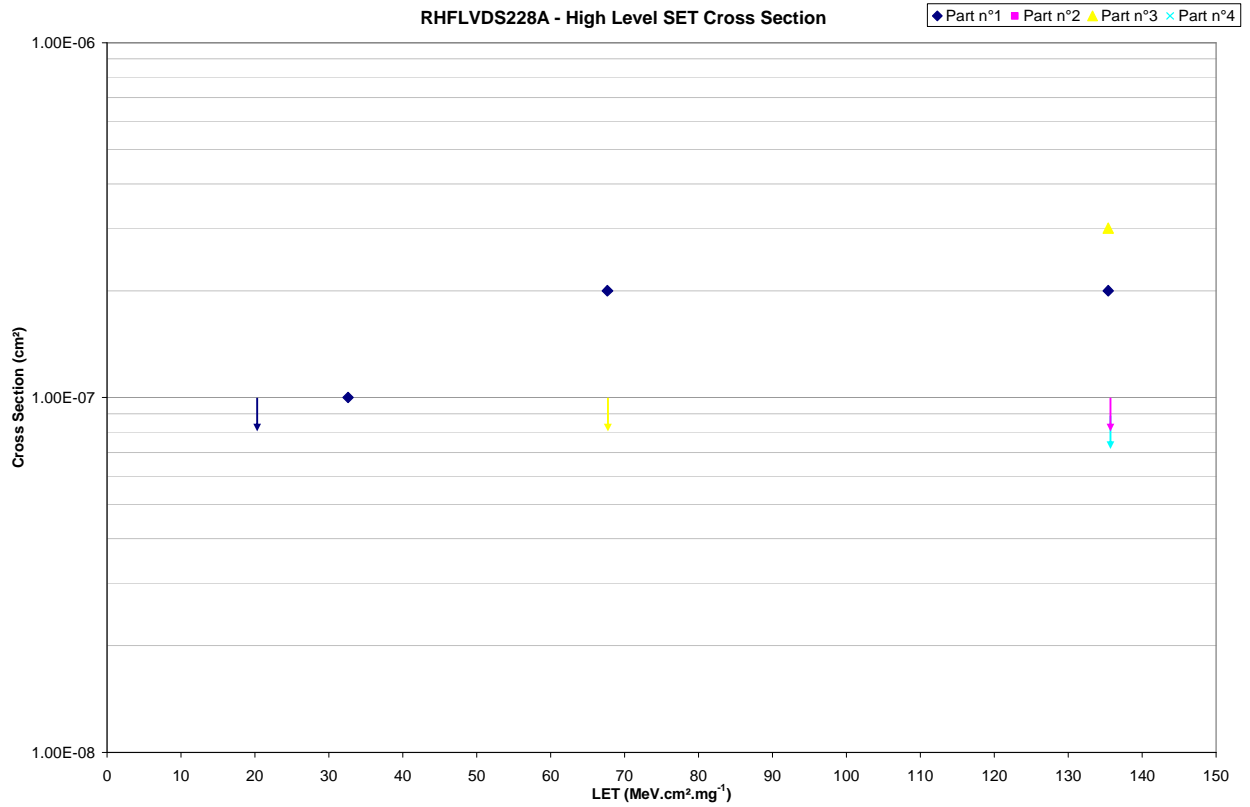

Figure 9: High level SET cross section curve for RHFLVDS228A.

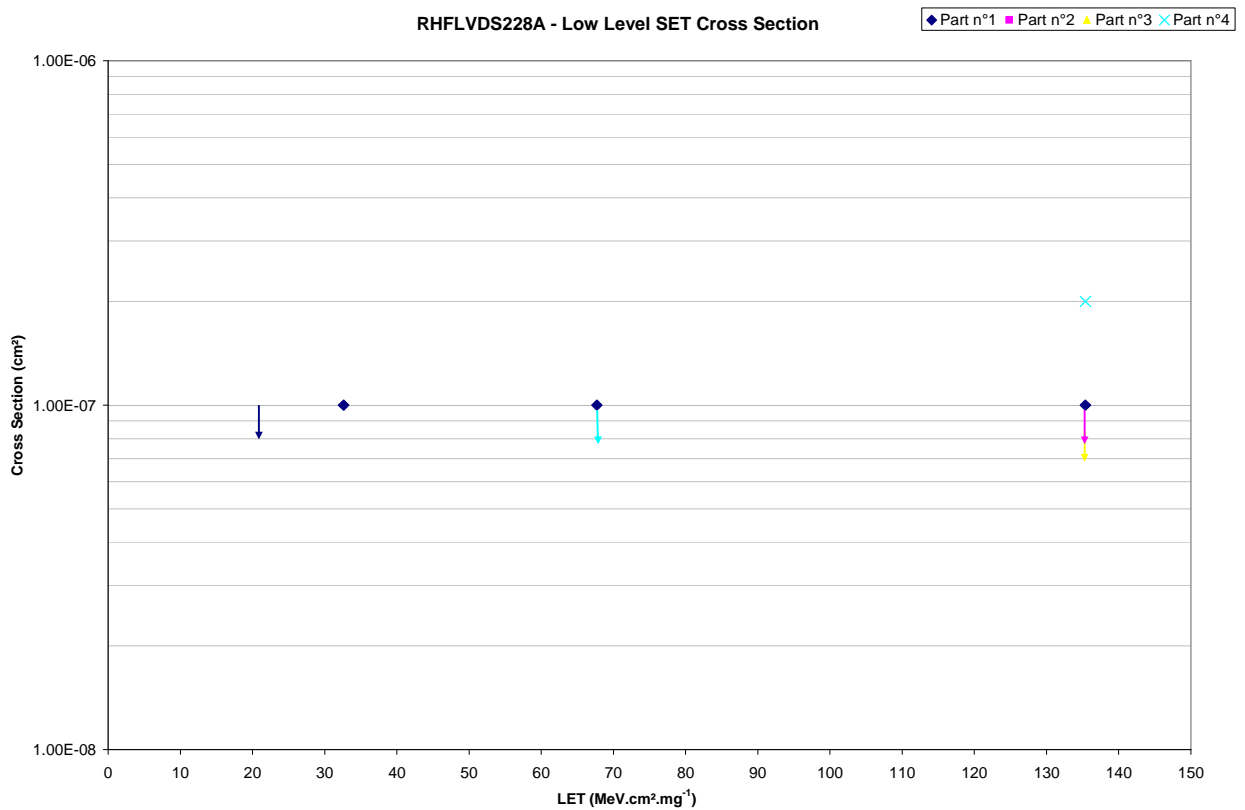

Figure 10: Low level SET cross section curve for RHFLVDS228A.

The tilted Xe runs were an express request of our customer.

8.3.2. Worst Cases SET Observed

The worst case on High level mode occurs on Part N°1 during run n°31 event n°1 (Xe, tilt = 60°, LET = 135.4 MeV.cm²/mg and range = 18.5µm).

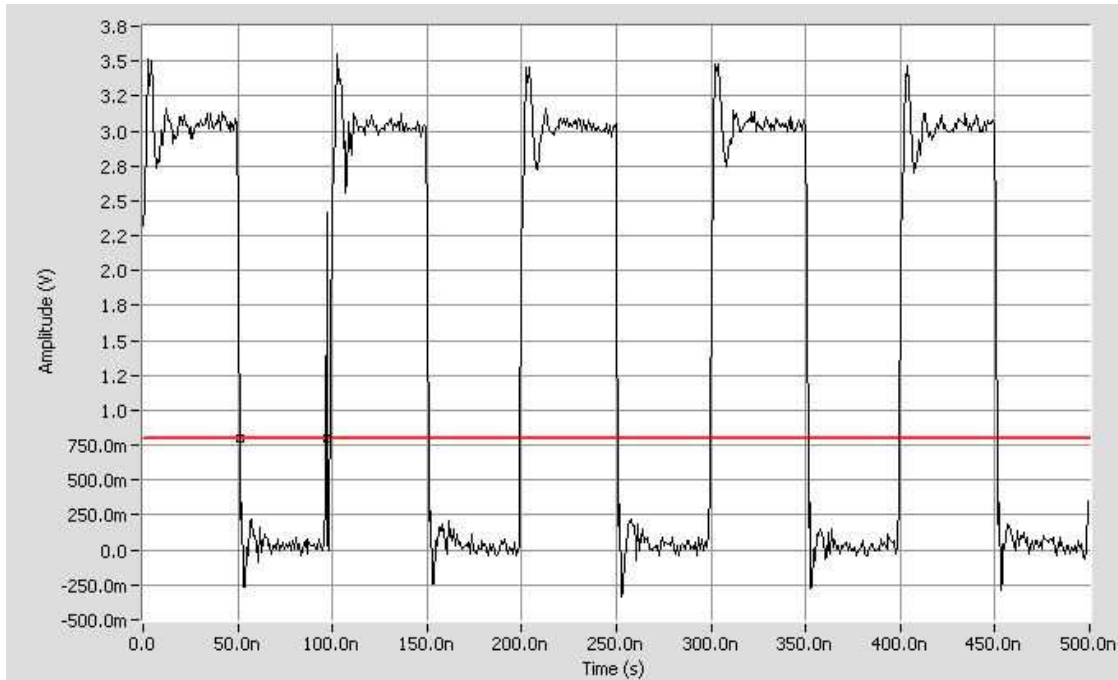

Figure 11: SET curve, Heavy Ion ¹²⁴Xe²⁶⁺ tilted 60° (LET of 135.4 MeV.mg/cm²), Part 1, Run n°31, Event n°1.

The worst case on Low level mode occurs on Part N°3 during run n°33 event n°1 (Xe, tilt = 60°, LET = 135.4 MeV.cm²/mg and range = 18.5µm).

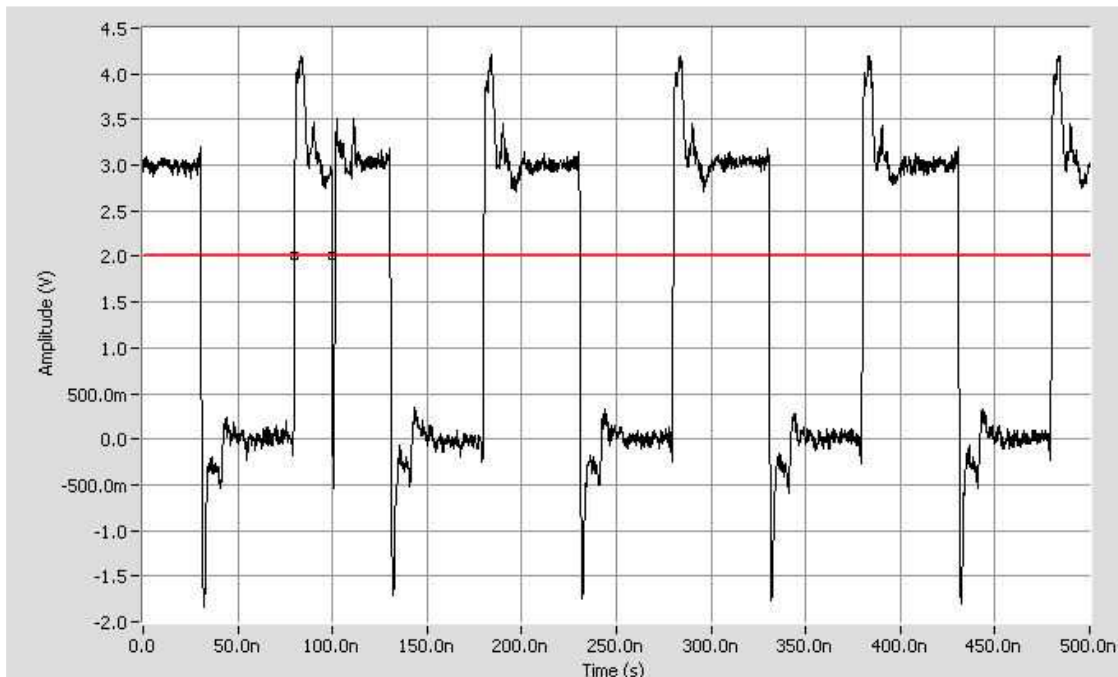

Figure 12: SET curve, Heavy Ion ¹²⁴Xe²⁶⁺ tilted 60° (LET of 135.4 MeV.mg/cm²), Part 3, Run n°33, Event n°1.

9. Conclusion

Heavy ions test were performed on RHFLVDS228A. The aim of the test was to evaluate the sensitivity of the device versus SEL and SET.

No SELs were observed with the LET value of 67.7MeV.cm²/mg (Xenon heavy ions).

SETs were observed on the RHFLVDS228A with a minimum LET of 32.6 MeV.cm²/mg. No SET was detected with a LET of 22.4 MeV.cm²/mg.

10. Appendix 1 UCL beam calibration sheets

FICHE DE CALIBRATION DU FAISCEAU HIF

Date de calibration : 29/08/2013

Semaine : W35

Opérateur(s) responsable(s) de la calibration : ML-JVH-KS

Cocktail : M/Q=5 - **M/Q = 3,33**

I. Profil du faisceau

Le profil du faisceau est mesuré à l'aide d'un détecteur de type PIPS. Le détecteur est centré dans la chambre d'irradiation et réalise 9 mesures selon les axes X et Y. Le faisceau doit être homogène à +/- 10% sur 20 mm aussi bien horizontalement que verticalement.

1) Profil Horizontal

Faisceau de référence :	$^{40}\text{Ar}^{12+}$ 372 MeV
Homogénéité horizontale :	24 mm
Valeur de X minimum (mm) :	-12 mm
Valeur X maximum (mm) :	+12 mm

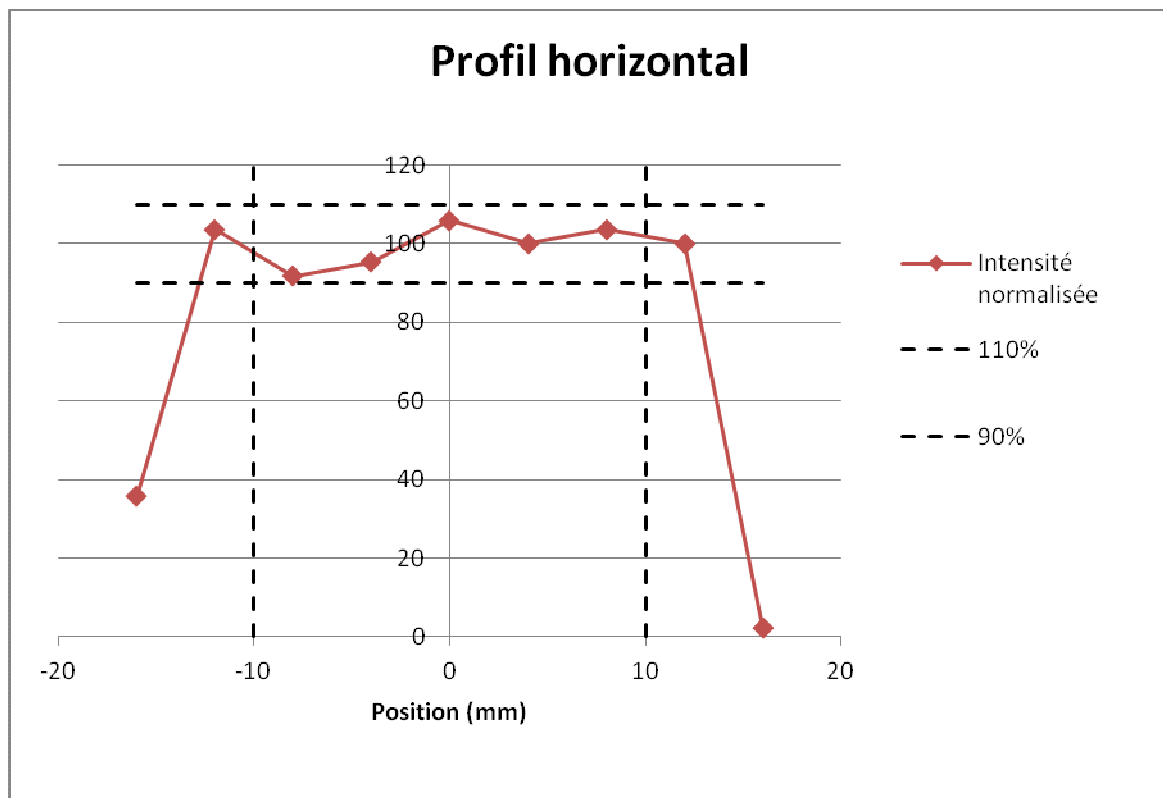

2) Scan Vertical

Faisceau de référence :	$^{40}\text{Ar}^{12+}$ 372 MeV
Homogénéité verticale :	24 mm
Valeur de Y minimum (mm) :	-12 mm
Valeur Y maximum (mm) :	+12 mm

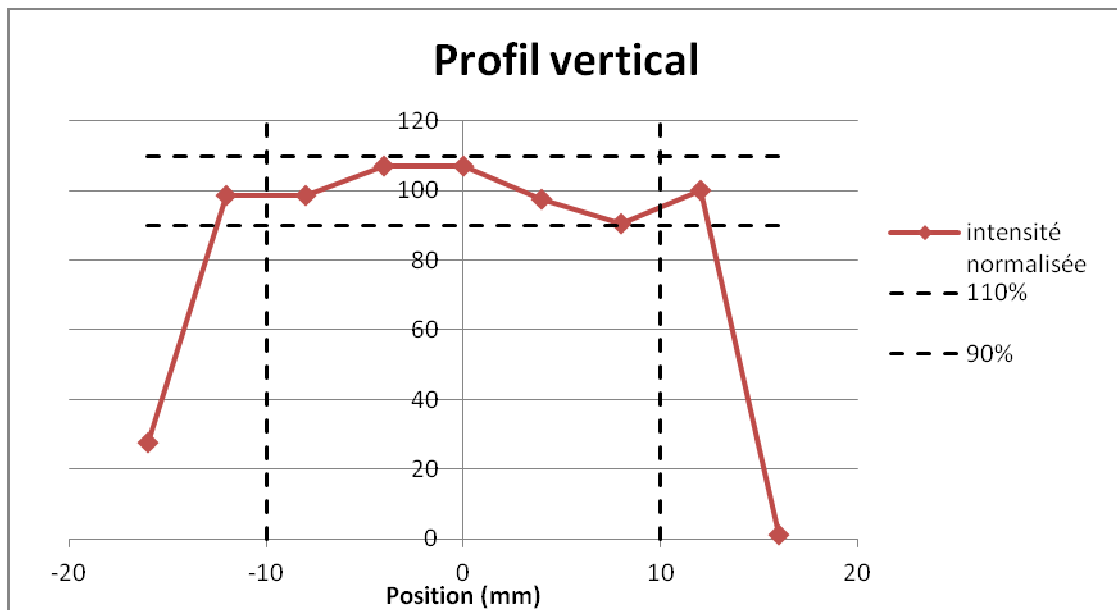

3) Profil transverse du faisceau mesuré avec le SEU Monitor

En plus de la procédure de scan, le profil du faisceau est contrôlé à l'aide du SEU Monitor fourni par l'ESA (20mm*20 mm). Tous les faisceaux du cocktail sont contrôlés par cette méthode. Seul le profil du faisceau de référence est présenté dans ce document mais les profils des autres ions du cocktail sont disponibles sur demande de l'utilisateur.

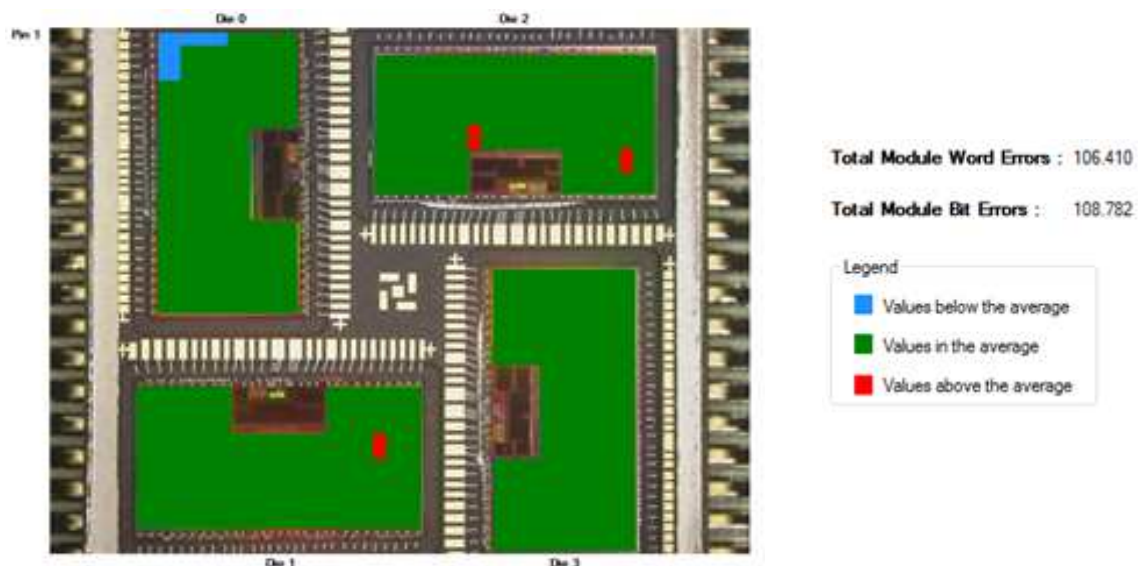

II. Calibration en énergie du faisceau

L'énergie de chaque faisceau est contrôlée par un chaîne de mesure comprenant un détecteur de type PIPS, une chaîne d'amplification et un analyseur multicanal avec son logiciel associé.

<u>Cocktail</u>	<u>Particule</u>	<u>Energie DUT (MeV)</u>	<u>Energie mesurée (MeV)</u>
M/Q = 3	$^{13}\text{C}^{4+}$	131	130
	$^{22}\text{Ne}^{7+}$	235	234
	$^{40}\text{Ar}^{12+}$	372	371
	$^{58}\text{Ni}^{18+}$	567	562*
	$^{83}\text{Kr}^{25+}$	756	749*

*Différence inhérente au détecteur PIPS "pulse height defect", liée notamment à un défaut de collection de charges pour les ions les plus lourds.

III. SEU MONITOR

Une vérification supplémentaire est réalisée à l'aide d'un SEU monitor fourni par l'ESA et servant de référence pour toutes les installations European Component Irradiation Facilities (ECIF). Celle-ci permet de vérifier la méthode de mesure dans son ensemble. Chaque ion du cocktail est mesuré à l'aide de ce composant de référence.

Courbe des sections efficace $\sigma_{(LET)}$

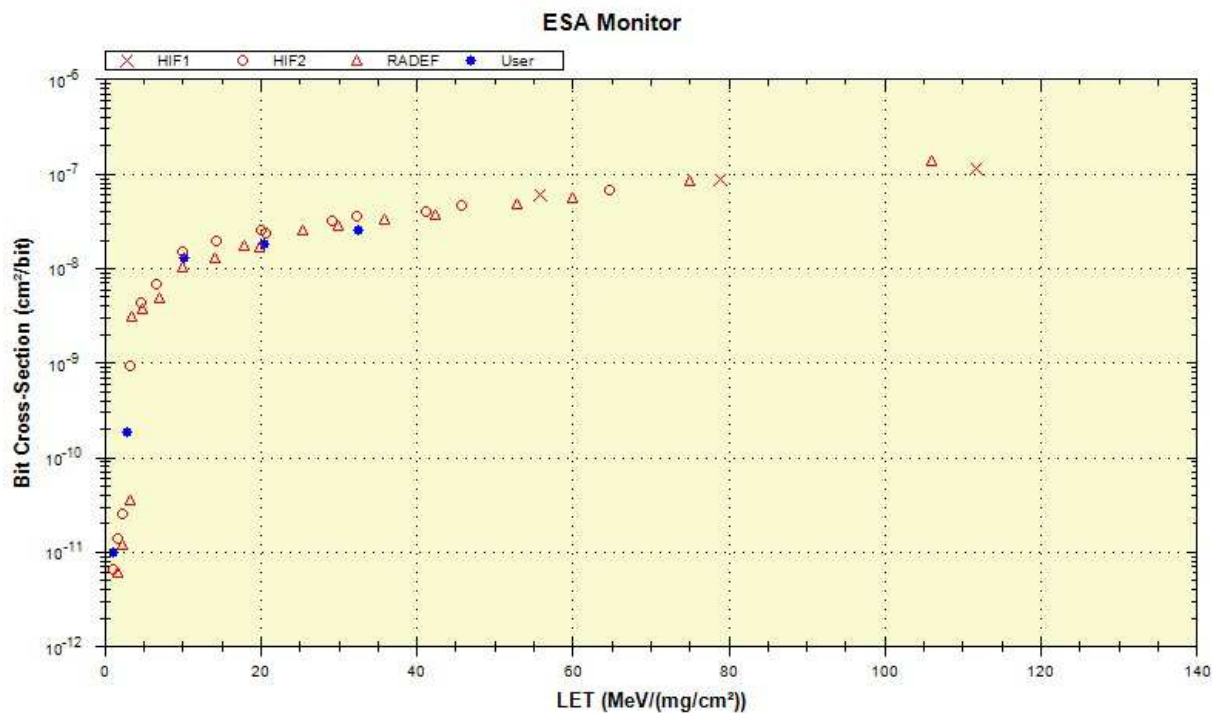

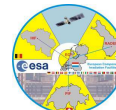

IV. Validation de la calibration

Remarque

Directeur du CRC

29 août 2013

M Loiselet

FICHE DE CALIBRATION DU FAISCEAU HIF

Date de calibration : 26/08/2013

Semaine : W35

Opérateur(s) responsable(s) de la calibration : ML-JVH-KS

Cocktail : **M/Q = 5** - M/Q = 3,33

I. Profil du faisceau

Le profil du faisceau est mesuré à l'aide d'un détecteur de type PIPS. Le détecteur est centré dans la chambre d'irradiation et réalise 9 mesures selon les axes X et Y. Le faisceau doit être homogène à +/- 10% sur 20 mm aussi bien horizontalement que verticalement.

1) Profil Horizontal

Faisceau de référence :	$^{40}\text{Ar}^{8+}$ 151 MeV
Homogénéité horizontale :	24 mm
Valeur de X minimum (mm) :	-12 mm
Valeur X maximum (mm) :	+12 mm

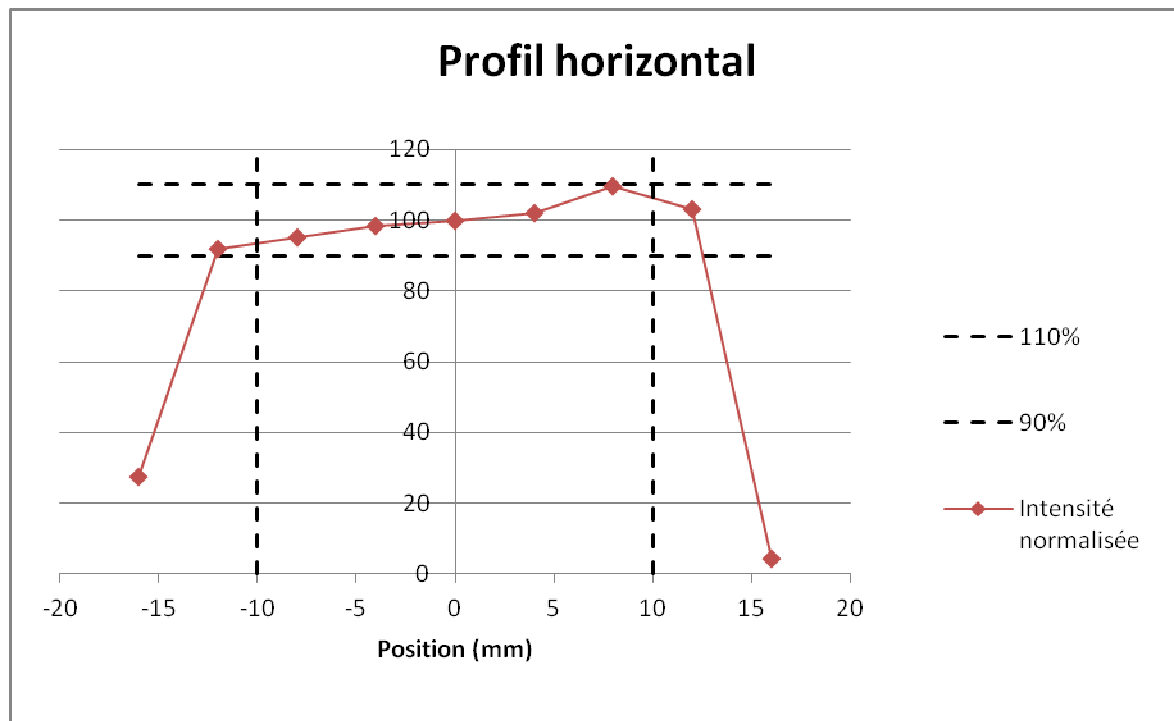

2) Scan Vertical

Faisceau de référence :	$^{40}\text{Ar}^{8+}$ 151 MeV
Homogénéité verticale :	24 mm
Valeur de Y minimum (mm) :	-12 mm
Valeur Y maximum (mm) :	+12 mm

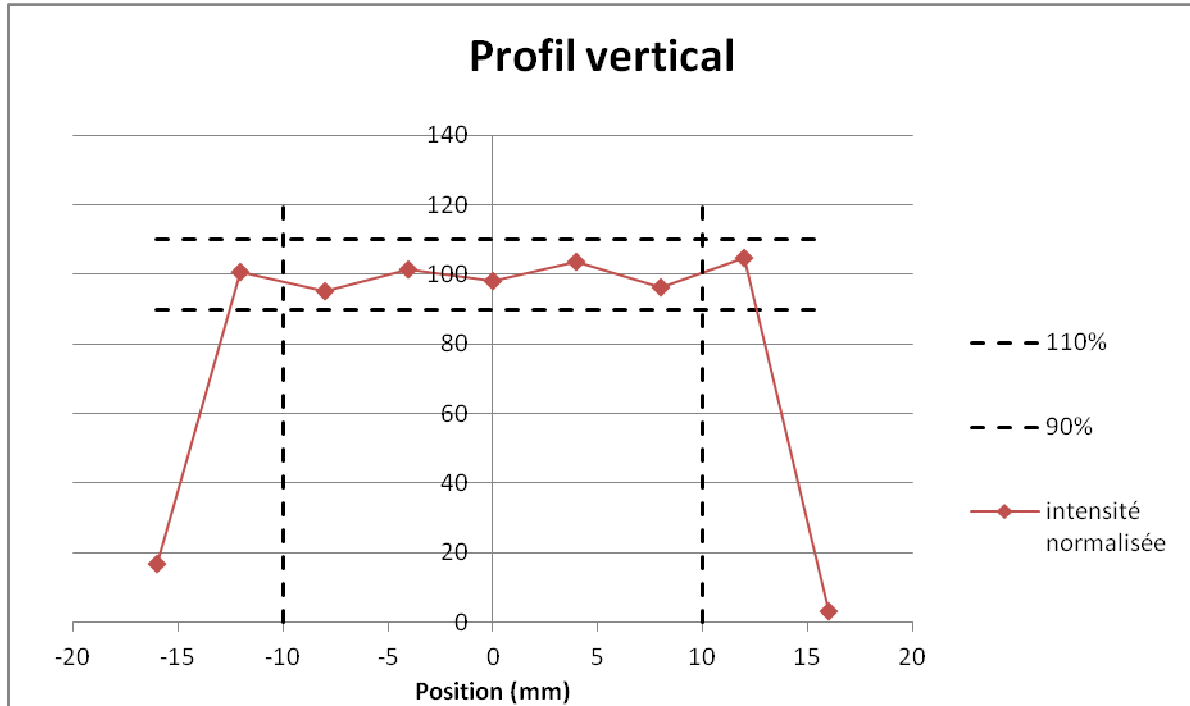

3) Profil transverse du faisceau mesuré avec le SEU Monitor

En plus de la procédure de scan, le profil du faisceau est contrôlé à l'aide du SEU Monitor fourni par l'ESA (20mm*20 mm). Tous les faisceaux du cocktail sont contrôlés par cette méthode. Seul le profil du faisceau de référence est présenté dans ce document mais les profils des autres ions du cocktail sont disponibles sur demande de l'utilisateur.

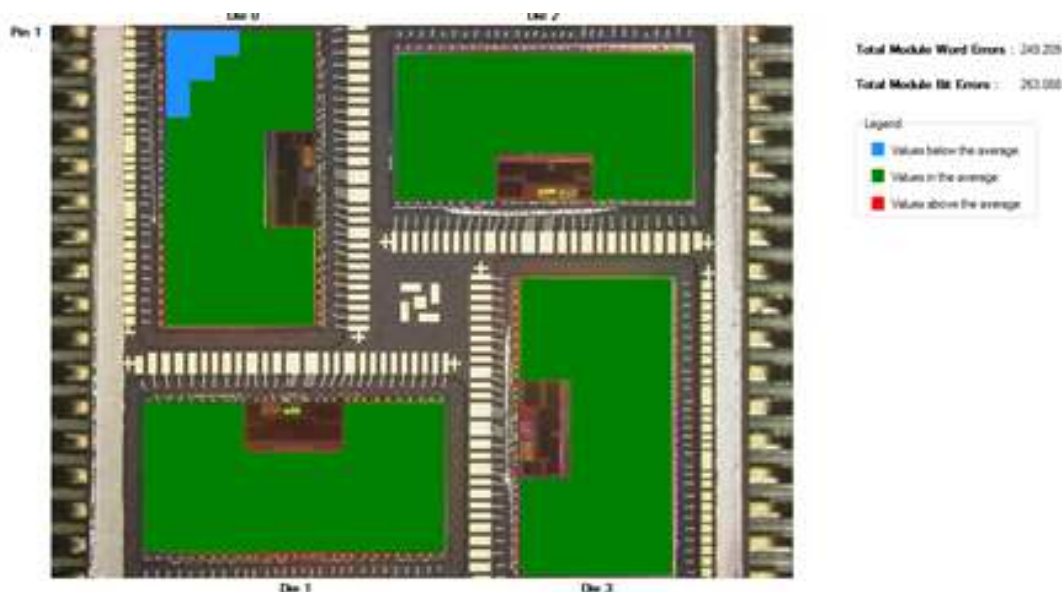

II. Calibration en énergie du faisceau

L'énergie de chaque faisceau est contrôlée par un chaîne de mesure comprenant un détecteur de type PIPS, une chaîne d'amplification et un analyseur multicanal avec son logiciel associé.

<u>Cocktail</u>	<u>Particule</u>	<u>Energie DUT (MeV)</u>	<u>Energie mesurée (MeV)</u>
M/Q = 5	$^{15}\text{N}^{3+}$	60	60
	$^{20}\text{Ne}^{4+}$	78	78
	$^{40}\text{Ar}^{8+}$	151	151
	$^{84}\text{Kr}^{17+}$	305	297*
	$^{124}\text{Xe}^{25+}$	420	399*

*Différence inhérente au détecteur PIPS "pulse height defect", liée notamment à un défaut de collection de charges pour les ions les plus lourds.

III. SEU MONITOR

Une vérification supplémentaire est réalisée à l'aide d'un SEU monitor fourni par l'ESA et servant de référence pour toutes les installations European Component Irradiation Facilities (ECIF). Celle-ci permet de vérifier la méthode de mesure dans son ensemble. Chaque ion du cocktail est mesuré à l'aide de ce composant de référence.

Courbe des sections efficace $\sigma_{(LET)}$

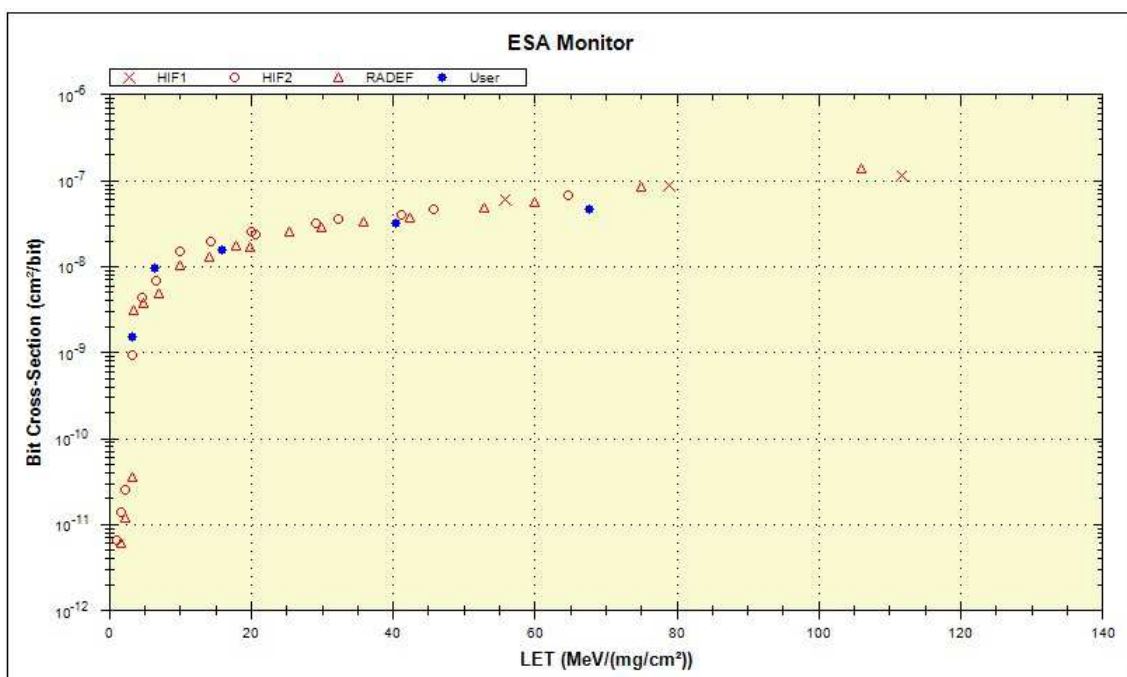



IV. Validation de la calibration

Remarque

Directeur du CRC

26 août 2013

M Loiselet

FICHE DE CALIBRATION DU FAISCEAU HIF

Date de calibration : 7/10/2013

Semaine : W41

Opérateur(s) responsable(s) de la calibration : KS-GU-LS-PJ-JVH

Cocktail : **M/Q = 5** - **M/Q = 3,33**

I. Profil du faisceau

Le profil du faisceau est mesuré à l'aide d'un détecteur de type PIPS. Le détecteur est centré dans la chambre d'irradiation et réalise 9 mesures selon les axes X et Y. Le faisceau doit être homogène à +/- 10% sur 20 mm aussi bien horizontalement que verticalement.

1) Profil Horizontal

Faisceau de référence :	$^{40}\text{Ar}^{8+}$ 151 MeV
Homogénéité horizontale :	24 mm
Valeur de X minimum (mm) :	-12 mm
Valeur X maximum (mm) :	+12 mm

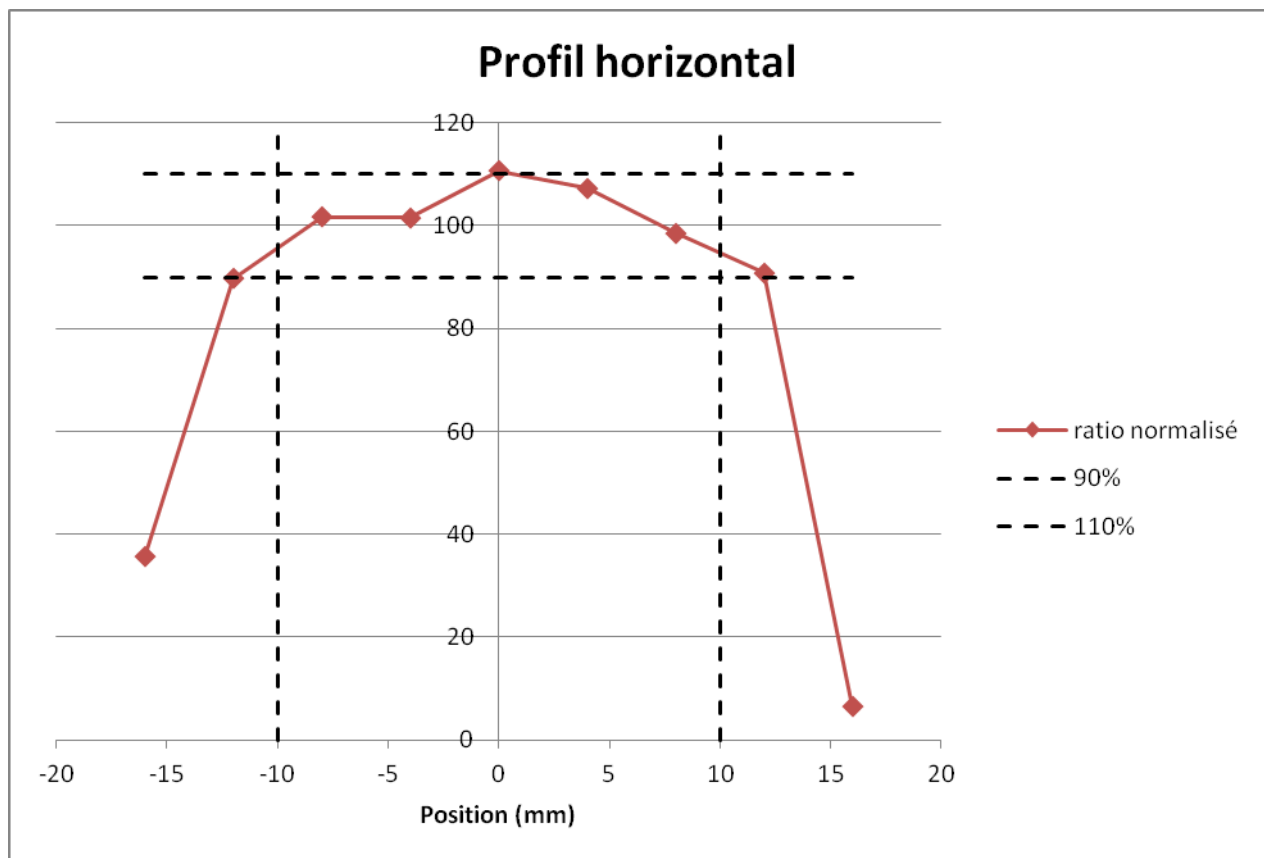



2) Scan Vertical

Faisceau de référence :	$^{40}\text{Ar}^{8+}$ 151 MeV
Homogénéité verticale :	24 mm
Valeur de Y minimum (mm) :	-12 mm
Valeur Y maximum (mm) :	+12 mm

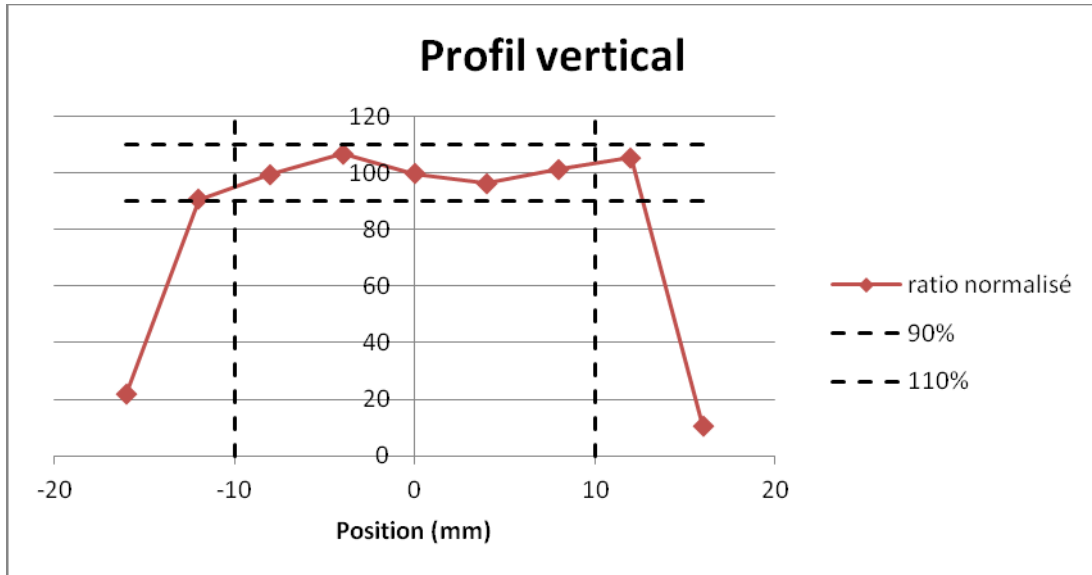

3) Profil transverse du faisceau mesuré avec le SEU Monitor

En plus de la procédure de scan, le profil du faisceau est contrôlé à l'aide du SEU Monitor fourni par l'ESA (20mm*20 mm). Tous les faisceaux du cocktail sont contrôlés par cette méthode. Seul le profil du faisceau de référence est présenté dans ce document mais les profils des autres ions du cocktail sont disponibles sur demande de l'utilisateur.

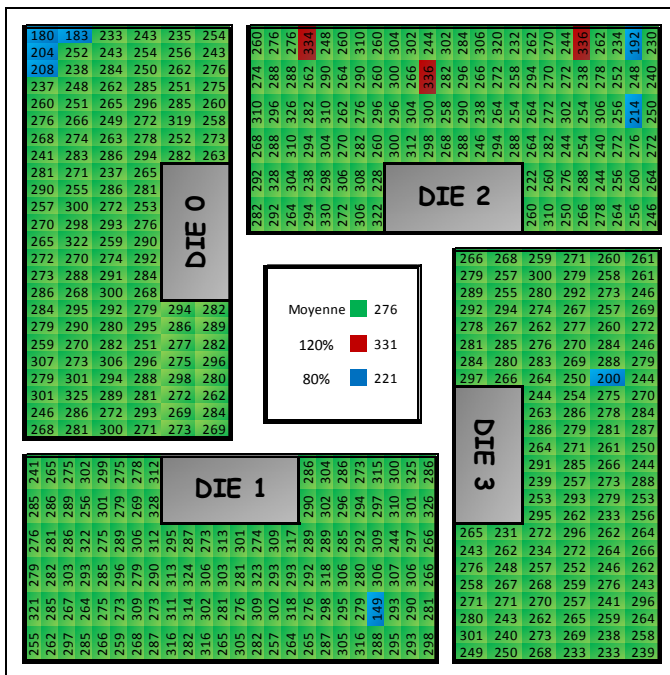

COKTAIL :	M/Q = 5	
ION :	40Ar8+	
ENERGIE DUT :	151	MeV
LET :	20,2	Mev/(mg/cm ²)
TOTAL WORD ERROR :	137337	
TOTAL BIT ERROR :	141346	
FLUENCE :	5,00E+05	Part/cm ²
CROSS SECTION :	1,685E-08	cm ² /bit



II. Calibration en énergie du faisceau

L'énergie de chaque faisceau est contrôlée par un chaîne de mesure comprenant un détecteur de type PIPS, une chaîne d'amplification et un analyseur multicanal avec son logiciel associé.

<u>Cocktail</u>	<u>Particule</u>	<u>Energie DUT (MeV)</u>	<u>Energie mesurée (MeV)</u>
M/Q = 5	$^{15}\text{N}^{3+}$	60	61
	$^{20}\text{Ne}^{4+}$	78	77
	$^{40}\text{Ar}^{8+}$	151	144*
	$^{84}\text{Kr}^{17+}$	305	276*
	$^{124}\text{Xe}^{25+}$	420	371*

*Différence inhérente au détecteur PIPS "pulse height defect", liée notamment à un défaut de collection de charges pour les ions les plus lourds.

III. SEU MONITOR

Une vérification supplémentaire est réalisée à l'aide d'un SEU monitor fourni par l'ESA et servant de référence pour toutes les installations European Component Irradiation Facilities (ECIF). Celle-ci permet de vérifier la méthode de mesure dans son ensemble. Chaque ion du cocktail est mesuré à l'aide de ce composant de référence.

Courbe des sections efficace $\sigma_{(LET)}$

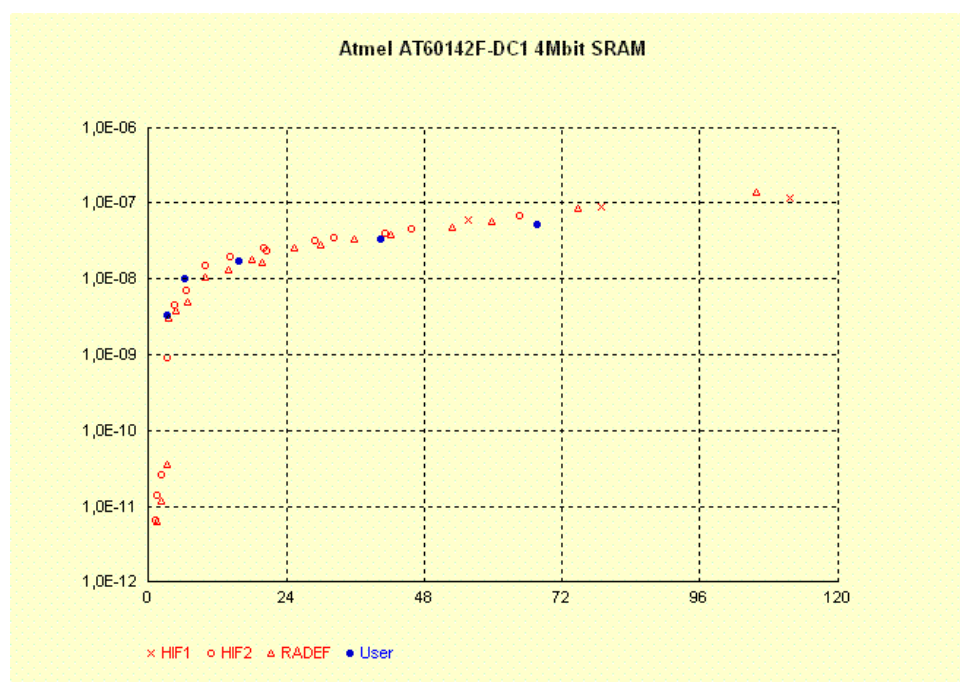



IV. Validation de la calibration

Remarque

La courbe des sections efficaces a été obtenue avec l'ancien SEU monitor fourni par l'ESA.

Directeur du CRC

9 septembre 2013

M Loiselet