

## TOTAL DOSE RADIATION TEST REPORT

<b>Part Type : BA06</b>
<b>Package : TO-39</b>
<b>Description : Transistors - Low power NPN</b>
<b>Manufacturer : STMicroelectronics</b>
<b>Date Code: 30945A</b>

**Alter Italy Purchase Order N° 5503571 dated 03/26/2010**

**Alter Italy Technical Responsible: Alessandro Cavagnoli**

<b>Hirex reference :</b>	HRX/TID/0770	Issue : 01	Date :	March 29 <sup>th</sup> , 2010
<b>Written by :</b>	C. BOUDOT	Technician	<i>Boudot</i>	
<b>Verified by :</b>	O.PERROTIN	Study Manager	<i>off</i>	
<b>Authorized by:</b>	J.F. PASCAL	Technical Manager	<i>JP</i>	



Hirex Engineering	Total Dose Radiation Test Report		Ref.:	HRX/TID/0770
	BA06	STMicroelectronics	Issue:	01

**TOTAL DOSE RADIATION TEST REPORT  
on BA06  
STMicroelectronics  
Transistors - Low power NPN**

**TABLE OF CONTENTS**

**1 INTRODUCTION.....4**

**2 APPLICABLE AND REFERENCE DOCUMENTS .....4**

    2.1 APPLICABLE DOCUMENTS .....4

    2.2 REFERENCE DOCUMENTS .....4

**3 TEST SAMPLES .....4**

**4 EXPERIMENTAL CONDITIONS.....5**

    4.1 RADIATION SOURCE DOSE RATE AND ANNEALING.....5

    4.2 BIAS DURING DOSE EXPOSURES AND MEASUREMENTS CONDITIONS.....6

        4.2.1 Bias conditions .....6

        4.2.2 Electrical Measurements.....7

**5 CONCLUSION.....9**

**6 TEST RESULTS.....10**

**List of figures:**

Figure 1 : View of the <sup>60</sup>Co γ source through the yellow lead window of the control room.....5

Figure 2 : Bias Conditions during Irradiation Exposures and Annealing .....6

Figure 3 : BA06 test program principle .....7

**List of Tables:**

Table 1 : Calliope main features .....5

Table 2 : Measured electrical parameters .....8

Table 3 : Summary of parameters failure levels .....9

Hirex Engineering	Total Dose Radiation Test Report		Ref.:	HRX/TID/0770
	BA06	STMicroelectronics	Issue:	01

## 1 Introduction

A total dose radiation verification test of the STMicroelectronics BA06, Transistors - Low power NPN has been performed with an accumulated dose of about 107 Krad(Si) at a dose rate of 275 rad(Si)/hour, in response to Alter Italy purchase order reference 5503571.

The purpose of this test was to evaluate total dose withstanding of this component, to investigate its suitability for being used in space applications. This test was conducted on samples provided by Alter Italy.

Test has been performed in accordance with Hirex Engineering proposal reference HRX/PRO/2906 Issue 01 dated 12/09/2009.

A complete set of electrical measurements together with graphical representation of measured parameters with respect to total dose received, are provided for all samples.

## 2 Applicable and Reference Documents

### 2.1 Applicable Documents

- Hirex Engineering proposal: HRX/PRO/2906 Issue 01 dated 12/09/2009
- Alter Italy specification: TPR/PL/STM/1152 issue 01 dated 12/17/2009.

### 2.2 Reference Documents

- NA

## 3 Test Samples

6 samples of the BA06 device were tested (5 ON + 1 control sample).

Samples were allocated into the bias conditions during exposures and annealing as provided in the following table.

Serial Number	Allocation
1	Control
2	Biased ON
3	Biased ON
4	Biased ON
5	Biased ON
6	Biased ON

Identification of the BA06 is given below:

**Part Number:** BA06

**Top Marking:** BA06 logo 30945A FR serial

**Diffusion Lot:**

**Date Code:** 30945A

## 4 Experimental Conditions

### 4.1 Radiation Source Dose Rate and Annealing

The dose exposures were performed at ENEA in the Calliope plant located at the CASACCIA research centre in ROME (Italy).

The  $\gamma$  irradiation plant is a pool-type irradiation facility equipped with a  $^{60}\text{Co}$  gamma source in a large shielded panoramic room. The storage water pool, that houses the source, has dimensions of 2x4.4x8 m<sup>3</sup>.

The emitted radiation has two photons of 1.173 and 1.332 MeV working in coincidence with a mean photon's energy of 1.25 MeV.

It is possible to vary the dose rate by simply adjusting the distance of devices under test to the source in a range of a few rad/H up to 2 Mrad/H.

The main Calliope features are reported in the table and Figure 1 below.

Source:	$^{60}\text{Co}$
Geometry:	Cylindrical rack with radioisotope pencils placed on two levels of external rack surface
Emitted radiation:	2 $\gamma$ photons emitted in coincidence
Photons Energy:	1.173 and 1.332 MeV (average 1.25 MeV)
Max licensed activity:	$3.7 \times 10^{15}$ Bq (100 kCi)
Dose rate range:	Few rad/h up to 2 Mrad/h

**Table 1 : Calliope main features**

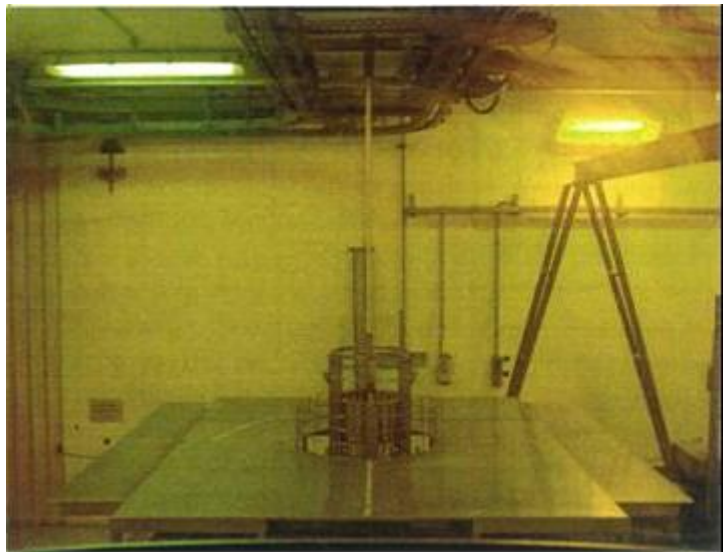

**Figure 1 : View of the  $^{60}\text{Co}$   $\gamma$  source through the yellow lead window of the control room**

The irradiation conditions used for this test are provided in the following table:

Irradiation Steps rads	Dose rate krads/h	Annealing steps Hours	Temperature °C
0			
25.9	0.275		Room
51.7	0.275		Room
77.5	0.275		Room
107.9	0.275		Room
		24	Room
		168	100

## 4.2 Bias during Dose Exposures and Measurements conditions

### 4.2.1 Bias conditions

During exposures test board allowed to bias 5 samples in accordance with the electrical circuit provided in Figure 1.

During annealing steps the same stress conditions were applied at 25°C and 100°C temperatures.

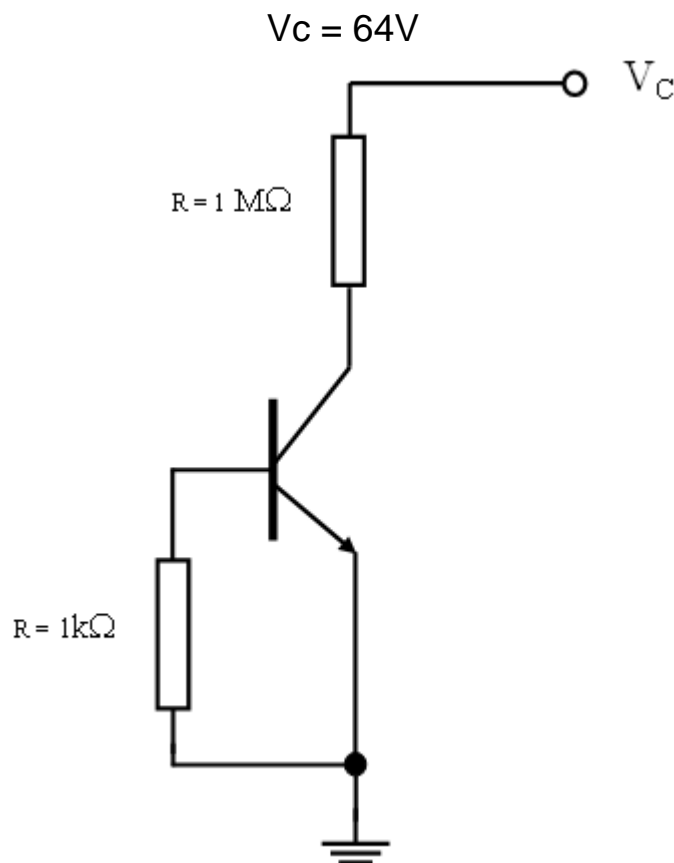

Figure 2 : Bias Conditions during Irradiation Exposures and Annealing

Hirex Engineering	Total Dose Radiation Test Report		Ref.:	HRX/TID/0770
	BA06	STMicroelectronics	Issue:	01

4.2.2 Electrical Measurements

Electrical parameters test program principle for BA06 is provided in Figure 2.

One HP4142 DC tester was used to perform required measurements.

A dedicated test fixture was designed to ensure proper measurement conditions. In addition a faraday cage was used to ensure optimum conditions for low level measurements.

Test results were automatically loaded in an Excel worksheet and compared in real time to specification limits.

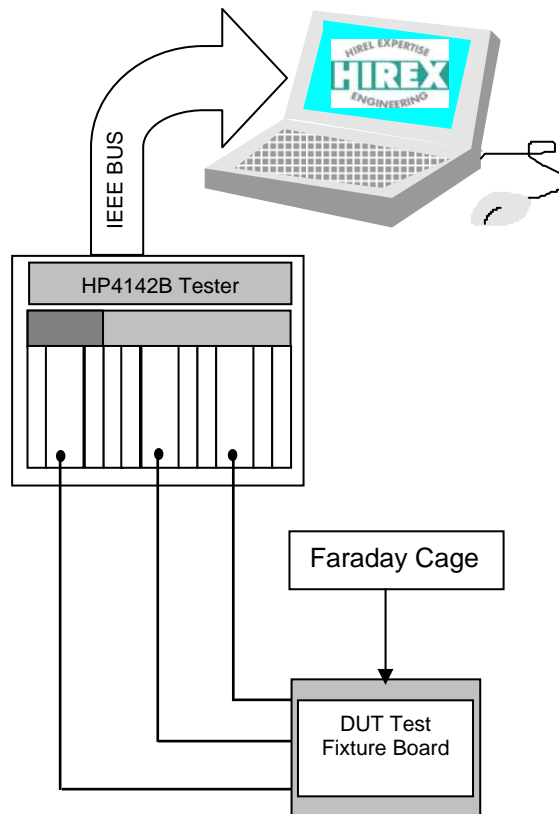

Figure 3 : BA06 test program principle

Electrical parameters test conditions and limits used for performing this test are given in the following table.

PARAMETERS	SYMBOLS	TEST CONDITIONS	MIN	MAX	UNITS
Collector emitter voltage base open	<a href="#">V<sub>ceo</sub></a>	I <sub>c</sub> = 100mA	60	-	V
Collector base cut off current	<a href="#">I<sub>cb0</sub></a>	V <sub>cb</sub> = 80V	-	100.0E-09	A
Emitter base cut off current	<a href="#">I<sub>eb0</sub></a>	V <sub>eb</sub> = 6V	-	100.0E-09	A
Forward current transfer ratio 1	<a href="#">h<sub>FE1</sub></a>	V <sub>ce</sub> = 2V I <sub>c</sub> = 100nA	10	-	-
Forward current transfer ratio 2	<a href="#">h<sub>FE2</sub></a>	V <sub>ce</sub> = 2V I <sub>c</sub> = 1μA	10	-	-
Forward current transfer ratio 3	<a href="#">h<sub>FE3</sub></a>	V <sub>ce</sub> = 2V I <sub>c</sub> = 100μA	10	-	-
Forward current transfer ratio 4	<a href="#">h<sub>FE4</sub></a>	V <sub>ce</sub> = 2V I <sub>c</sub> = 1mA	10	-	-
Forward current transfer ratio 5	<a href="#">h<sub>FE5</sub></a>	V <sub>ce</sub> = 2V I <sub>c</sub> = 10mA	10	-	-
Forward current transfer ratio 6	<a href="#">h<sub>FE6</sub></a>	V <sub>ce</sub> = 2V I <sub>c</sub> = 100mA	80	-	-
Forward current transfer ratio 7	<a href="#">h<sub>FE7</sub></a>	V <sub>ce</sub> = 2V I <sub>c</sub> = 500mA	10	-	-
Forward current transfer ratio 8	<a href="#">h<sub>FE8</sub></a>	V <sub>ce</sub> = 2V I <sub>c</sub> = 1A	160	400	-
Forward current transfer ratio 9	<a href="#">h<sub>FE9</sub></a>	V <sub>ce</sub> = 2V I <sub>c</sub> = 2A	10	-	-
Collector emitter saturation voltage	<a href="#">V<sub>ce(sat)1</sub></a>	I <sub>c</sub> = 2A I <sub>b</sub> = 100mA	-	0.4	V
Collector emitter saturation voltage	<a href="#">V<sub>ce(sat)2</sub></a>	I <sub>c</sub> = 3A I <sub>b</sub> = 150mA	-	0.5	V
Base emitter saturation voltage	<a href="#">V<sub>be(sat)</sub></a>	I <sub>c</sub> = 2A I <sub>b</sub> = 100mA	-	1.2	V
Base emitter voltage	<a href="#">V<sub>be1</sub></a>	I <sub>c</sub> = 100nA V <sub>ce</sub> = 2V	-	1.5	V
Base emitter voltage	<a href="#">V<sub>be2</sub></a>	I <sub>c</sub> = 1μA V <sub>ce</sub> = 2V	-	1.5	V
Base emitter voltage	<a href="#">V<sub>be3</sub></a>	I <sub>c</sub> = 100μA V <sub>ce</sub> = 2V	-	1.5	V
Base emitter voltage	<a href="#">V<sub>be4</sub></a>	I <sub>c</sub> = 1mA V <sub>ce</sub> = 2V	-	1.5	V
Base emitter voltage	<a href="#">V<sub>be5</sub></a>	I <sub>c</sub> = 10mA V <sub>ce</sub> = 2V	-	1.5	V
Base emitter voltage	<a href="#">V<sub>be6</sub></a>	I <sub>c</sub> = 100mA V <sub>ce</sub> = 2V	0.63	0.73	V
Base emitter voltage	<a href="#">V<sub>be7</sub></a>	I <sub>c</sub> = 500mA V <sub>ce</sub> = 2V	-	1.5	V
Base emitter voltage	<a href="#">V<sub>be8</sub></a>	I <sub>c</sub> = 1A V <sub>ce</sub> = 2V	-	1.5	V
Base emitter voltage	<a href="#">V<sub>be9</sub></a>	I <sub>c</sub> = 2A V <sub>ce</sub> = 2V	-	1.5	V

**Table 2 : Measured electrical parameters**



Hirex Engineering	Total Dose Radiation Test Report		Ref.:	HRX/TID/0770
	BA06	STMicroelectronics	Issue:	01

## 5 Conclusion

A Total Ionizing Dose verification test was carried out by Hirex Engineering under Alter Italy contract on the STMicroelectronics BA06 Transistors - Low power NPN in TO-39 package. 5 samples plus one control sample were used during testing. They were exposed to radiation using a dose rate of 275 rad(Si)/hour at room temperature.

A summary of the failure levels for each concerned parameter is provided in the following table. Parameters not listed remained within specification limits all along testing. Detail test results are presented in the following section.

Parameters	Failure Level between :		Annealing Recovery [Note 1]					Comments
			NA	No	Partial	Complete	Rebound	
<a href="#">HFE1</a>	ON samples	25.9 & 51.7 kRad(Si)			X			
<a href="#">HFE2</a>	ON samples	51.7 & 77.5 kRad(Si)				X		

[Note 1]: **NA** = Not applicable, **No**: means no sample has recovered, **Partial**: means at least one sample has recovered, **Complete**: means all samples have recovered, **Rebound**: means rebound has been observed on at least one sample.

**Table 3 : Summary of parameters failure levels**

Notes :

[1]: Complete recovery for HFE2 means that samples have been found within specification limits, but initial values obtained at initial readings have not been recovered.

[2]: SN 6 was send back to Alter Italy on his demand after 107 kRad(Si) exposure step. Consequently, there is no data on this sample after 24h and 168h annealing steps.

Hirex Engineering	Total Dose Radiation Test Report		Ref.:	HRX/TID/0770
	BA06	STMicroelectronics	Issue:	01

## 6 Test Results

Test results including tables and graphics are provided in this section for each measured parameter.

Failed values with respect to specified limits are highlighted in bold red font in the tables.

Post irradiation values are calculated using  $3\sigma$  approach.

- For positive variation  $(X)_{\text{LOT+}} = \text{mean}(X) + 3 \times \sigma(X)$
- For negative variation  $(X)_{\text{LOT-}} = \text{mean}(X) - 3 \times \sigma(X)$
- $(X)_{\text{LOT WORST CASE}} = \text{Worstcase}((X)_{\text{LOT+}}, (X)_{\text{LOT-}})$

Post irradiation parameters drifts (noted  $\Delta X$ ) are defined as follows:

$$\Delta X = X_{\text{post rad}} - X_{\text{initial}}$$

Where  $X_{\text{post rad}}$  stands for the value of X after irradiation (at 50krads (Si), 70krads (Si) or 100krads (Si)) and  $X_{\text{initial}}$  stands for the pre-irradiation value of X.

Post irradiation drift values are calculated using  $3\sigma$  approach.

- For positive variation  $\Delta(X)_{\text{LOT+}} = \text{mean}(\Delta X) + 3 \times \sigma(\Delta X)$
- For negative variation  $\Delta(X)_{\text{LOT-}} = \text{mean}(\Delta X) - 3 \times \sigma(\Delta X)$
- $\Delta(X)_{\text{LOT WORST CASE}} = \text{Worstcase}(\Delta(X)_{\text{LOT+}}, \Delta(X)_{\text{LOT-}})$

For bipolar transistors, drifts on forward current transfer ratio are calculated as follows:

$$\Delta\left(\frac{1}{h_{FE}}\right)_{\text{LOT}} = \text{mean}\left(\Delta\frac{1}{h_{FE}}\right) + 3 \times \sigma\left(\Delta\frac{1}{h_{FE}}\right)$$

$$[h_{FE}]_{\text{POST RAD}} = \frac{1}{\Delta\left(\frac{1}{h_{FE}}\right)_{\text{LOT}} + \frac{1}{h_{FE(\text{min})}}}$$

Where  $\sigma$  stands for standard deviation and  $h_{FE(\text{min})}$  stands for the pre-irradiation spec minimum  $h_{FE}$  limit available in table 2.

**Test conditions : TID**  
**Parameter : Collector to Emitter Breakdown Voltage : V(BR)CEO**  
**Ic = 100mA**  
 Unit : V  
 Spec Limit Min : 60.0  
 Spec limits are represented in bold lines on the graphic.

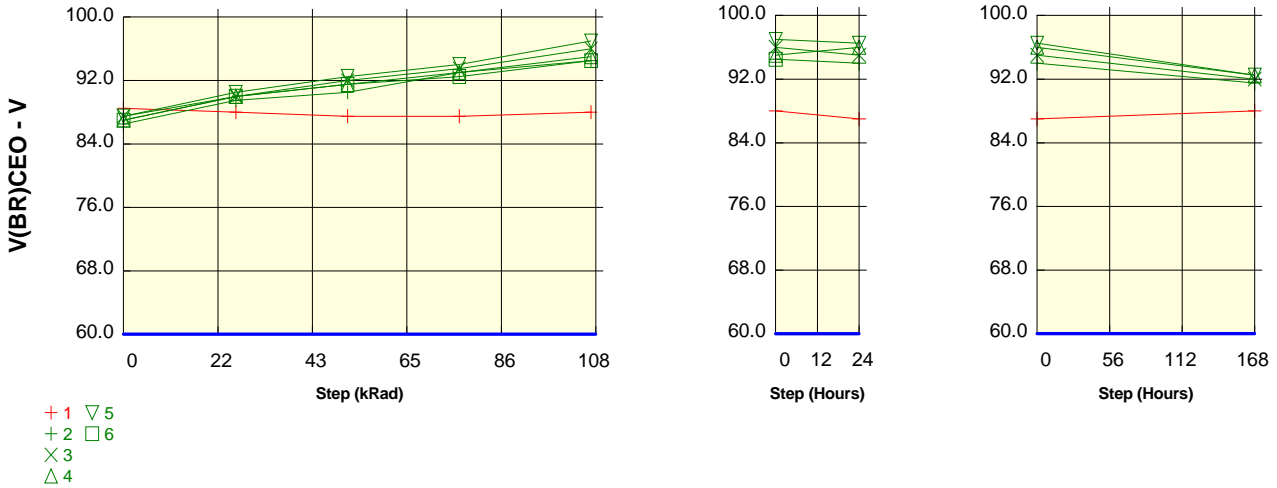

**Measurements**

V(BR)CEO	0 kRad	25.9 kRad	51.7 kRad	77.5 kRad	107.9 kRad	24 Hours	168 Hours
1_REF	88.5	88.0	87.5	87.5	88.0	87.0	88.0
<b>ON samples</b>							
2	86.5	89.5	90.5	93.0	94.5	94.0	91.5
3	87.5	90.0	92.0	93.5	96.0	95.0	92.0
4	87.0	90.0	91.5	93.0	95.0	96.0	92.5
5	87.5	90.5	92.5	94.0	97.0	96.5	92.5
6	87.0	90.0	91.5	92.5	94.5		
<b>Statistics</b>							
Min	86.5	89.5	90.5	92.5	94.5	94.0	91.5
Max	87.5	90.5	92.5	94.0	97.0	96.5	92.5
Average	87.1	90.0	91.6	93.2	95.4	95.4	92.1
Sigma	0.4	0.3	0.7	0.5	1.0	1.0	0.4
(V(B) Lot WorstCase	86.0	89.1	89.6	91.7	92.5	92.5	90.9

**Drift Calculation**

V(BR)CEO	0 kRad	25.9 kRad	51.7 kRad	77.5 kRad	107.9 kRad	24 Hours	168 Hours
<b>ON samples</b>							
2	-	3.00E+00	4.00E+00	6.50E+00	8.00E+00	7.50E+00	5.00E+00
3	-	2.50E+00	4.50E+00	6.00E+00	8.50E+00	7.50E+00	4.50E+00
4	-	3.00E+00	4.50E+00	6.00E+00	8.00E+00	9.00E+00	5.50E+00
5	-	3.00E+00	5.00E+00	6.50E+00	9.50E+00	9.00E+00	5.00E+00
6	-	3.00E+00	4.50E+00	5.50E+00	7.50E+00		
Average	-	2.90E+00	4.50E+00	6.10E+00	8.30E+00	8.25E+00	5.00E+00
Sigma	-	200.00E-03	316.23E-03	374.17E-03	678.23E-03	750.00E-03	353.55E-03
d(V(B) Lot WorstCase	-	2.30E+00	3.55E+00	4.98E+00	6.27E+00	6.00E+00	3.94E+00

**Test conditions : TID**  
**Parameter : Collector Base cut-off current : ICBO**  
**Vcb = 80V**  
 Unit : A  
 Spec Limit Max : 100.0E-09  
 Spec limits are represented in bold lines on the graphic.

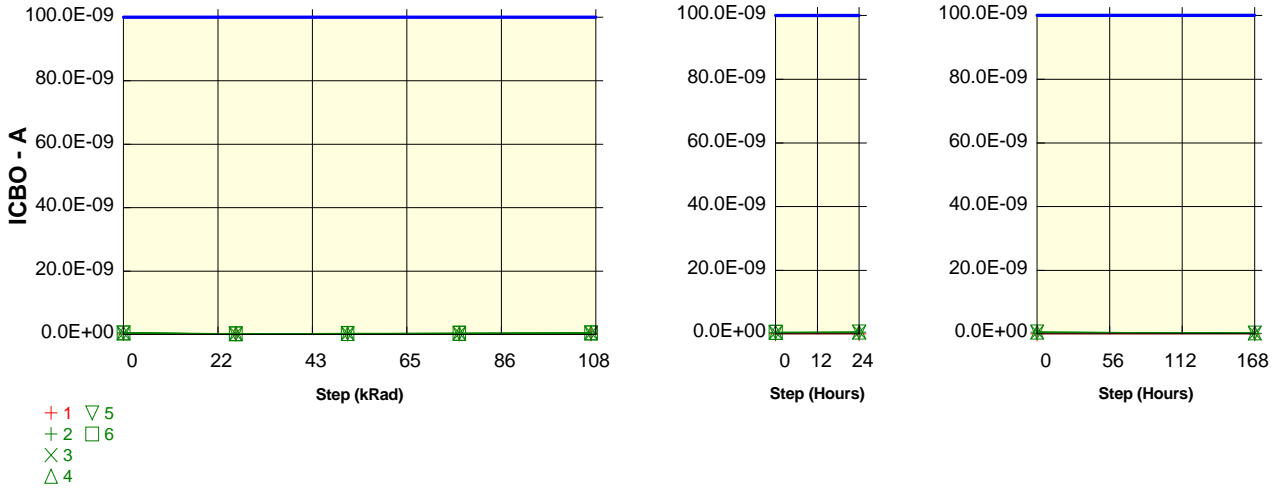

**Measurements**

ICBO	0 kRad	25.9 kRad	51.7 kRad	77.5 kRad	107.9 kRad	24 Hours	168 Hours
<b>1_REF</b>	164.8E-12	164.5E-12	63.1E-12	35.9E-12	38.2E-12	46.9E-12	56.1E-12
<b>ON samples</b>							
<b>2</b>	523.7E-12	216.7E-12	284.4E-12	328.4E-12	392.3E-12	542.9E-12	220.0E-12
<b>3</b>	430.6E-12	250.6E-12	331.5E-12	385.0E-12	471.9E-12	562.8E-12	259.4E-12
<b>4</b>	484.8E-12	263.2E-12	317.0E-12	358.5E-12	499.8E-12	555.7E-12	302.3E-12
<b>5</b>	581.5E-12	225.2E-12	377.5E-12	410.5E-12	543.5E-12	592.3E-12	311.8E-12
<b>6</b>	470.4E-12	294.2E-12	292.5E-12	371.7E-12	508.9E-12		
<b>Statistics</b>							
<b>Min</b>	430.6E-12	216.7E-12	284.4E-12	328.4E-12	392.3E-12	542.9E-12	220.0E-12
<b>Max</b>	581.5E-12	294.2E-12	377.5E-12	410.5E-12	543.5E-12	592.3E-12	311.8E-12
<b>Average</b>	498.2E-12	250.0E-12	320.6E-12	370.8E-12	483.3E-12	563.4E-12	273.4E-12
<b>Sigma</b>	51.2E-12	27.7E-12	33.1E-12	27.3E-12	50.9E-12	18.1E-12	36.6E-12
<b>(ICB) Lot WorstCase</b>	651.8E-12	333.2E-12	419.7E-12	452.7E-12	636.1E-12	617.8E-12	383.2E-12

**Drift Calculation**

ICBO	0 kRad	25.9 kRad	51.7 kRad	77.5 kRad	107.9 kRad	24 Hours	168 Hours
<b>ON samples</b>							
<b>2</b>	-	-307.02E-12	-239.32E-12	-195.35E-12	-131.43E-12	19.15E-12	-303.79E-12
<b>3</b>	-	-180.02E-12	-99.16E-12	-45.60E-12	41.32E-12	132.16E-12	-171.20E-12
<b>4</b>	-	-221.60E-12	-167.76E-12	-126.28E-12	14.96E-12	70.86E-12	-182.48E-12
<b>5</b>	-	-356.26E-12	-204.04E-12	-171.00E-12	-37.96E-12	10.76E-12	-269.68E-12
<b>6</b>	-	-176.20E-12	-177.94E-12	-98.68E-12	38.54E-12		
<b>Average</b>	-	-248.22E-12	-177.64E-12	-127.38E-12	-14.91E-12	58.23E-12	-231.79E-12
<b>Sigma</b>	-	71.66E-12	46.39E-12	52.98E-12	64.84E-12	48.49E-12	56.40E-12
<b>d(ICB) Lot WorstCase</b>	-	-33.24E-12	-38.49E-12	31.56E-12	179.60E-12	203.71E-12	-62.60E-12

**Test conditions : TID**  
**Parameter : Emitter Base cut-off current : IEBO**  
**Veb = 6V**  
 Unit : A  
 Spec Limit Max : 100.0E-09  
 Spec limits are represented in bold lines on the graphic.

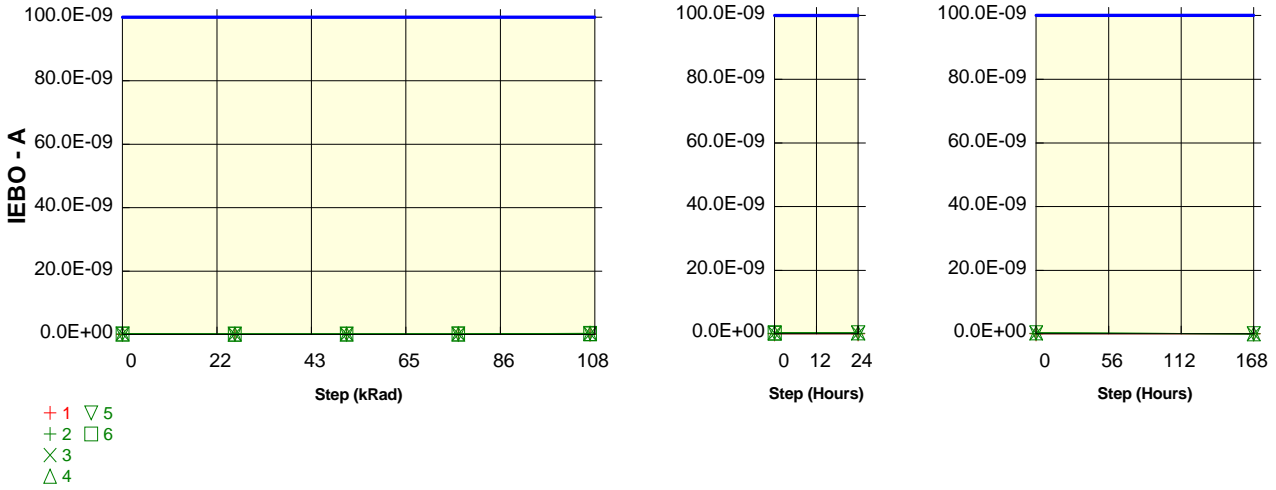

**Measurements**

IEBO	0 kRad	25.9 kRad	51.7 kRad	77.5 kRad	107.9 kRad	24 Hours	168 Hours
<b>1_REF</b>	9.1E-12	9.8E-12	28.0E-12	5.1E-12	2.5E-12	4.7E-12	5.5E-12
<b>ON samples</b>							
2	245.7E-12	114.0E-12	126.4E-12	158.1E-12	215.4E-12	254.6E-12	46.6E-12
3	236.5E-12	101.8E-12	140.1E-12	166.8E-12	255.8E-12	273.0E-12	56.6E-12
4	180.0E-12	132.1E-12	117.0E-12	153.9E-12	325.8E-12	299.4E-12	49.4E-12
5	205.5E-12	120.9E-12	139.1E-12	175.5E-12	364.4E-12	326.6E-12	73.4E-12
6	148.1E-12	95.5E-12	118.9E-12	149.9E-12	227.2E-12		
<b>Statistics</b>							
<b>Min</b>	148.1E-12	95.5E-12	117.0E-12	149.9E-12	215.4E-12	254.6E-12	46.6E-12
<b>Max</b>	245.7E-12	132.1E-12	140.1E-12	175.5E-12	364.4E-12	326.6E-12	73.4E-12
<b>Average</b>	203.2E-12	112.8E-12	128.3E-12	160.8E-12	277.7E-12	288.4E-12	56.5E-12
<b>Sigma</b>	36.0E-12	13.1E-12	9.7E-12	9.2E-12	57.9E-12	27.2E-12	10.4E-12
<b>(IEB) Lot WorstCase</b>	311.3E-12	152.1E-12	157.5E-12	188.6E-12	451.3E-12	370.0E-12	87.7E-12

**Drift Calculation**

IEBO	0 kRad	25.9 kRad	51.7 kRad	77.5 kRad	107.9 kRad	24 Hours	168 Hours
<b>ON samples</b>							
2	-	-131.70E-12	-119.28E-12	-87.58E-12	-30.26E-12	8.94E-12	-199.06E-12
3	-	-134.72E-12	-96.44E-12	-69.72E-12	19.32E-12	36.44E-12	-179.90E-12
4	-	-47.93E-12	-62.96E-12	-26.10E-12	145.84E-12	119.46E-12	-130.54E-12
5	-	-84.63E-12	-66.44E-12	-29.98E-12	158.88E-12	121.10E-12	-132.14E-12
6	-	-52.60E-12	-29.18E-12	1.80E-12	79.08E-12		
<b>Average</b>	-	-90.32E-12	-74.86E-12	-42.32E-12	74.57E-12	71.48E-12	-160.41E-12
<b>Sigma</b>	-	37.25E-12	30.78E-12	32.13E-12	72.46E-12	49.76E-12	29.85E-12
<b>d(IEB) Lot WorstCase</b>	-	21.42E-12	17.49E-12	54.07E-12	291.94E-12	220.76E-12	-70.85E-12

**Test conditions : TID**  
**Parameter : Forward current transfer ratio 1 : HFE1**  
**Vce = 2V ; Ic = 100nA**  
 Unit :  
 Spec Limit Min : 10.00  
 Spec limits are represented in bold lines on the graphic.

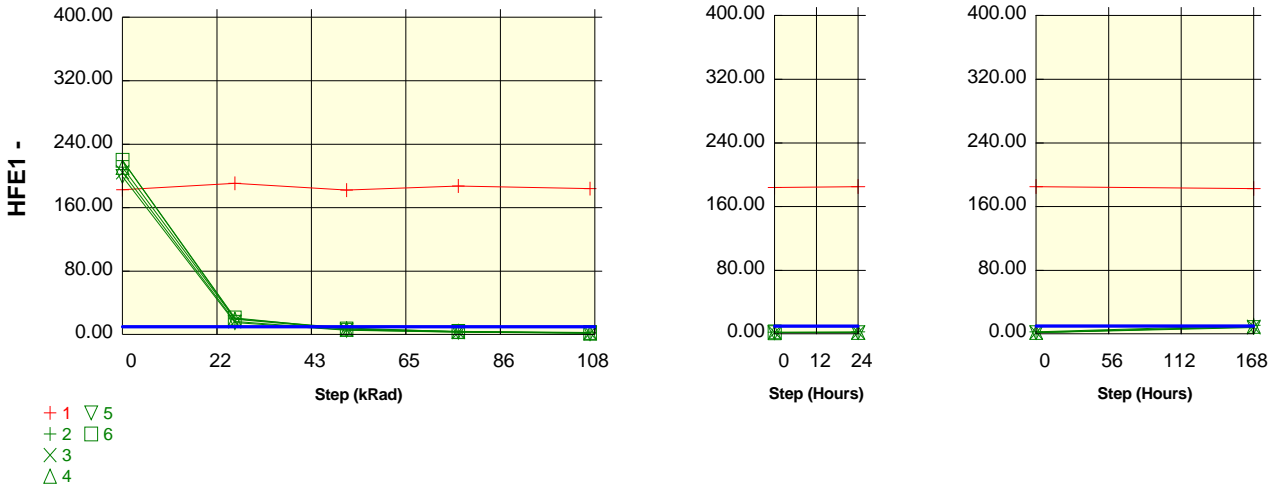

**Measurements**

HFE1	0 kRad	25.9 kRad	51.7 kRad	77.5 kRad	107.9 kRad	24 Hours	168 Hours
1_REF	182.63	190.64	182.14	187.27	184.02	185.14	182.78
<b>ON samples</b>							
2	219.31	19.75	8.14	3.79	2.39	2.62	11.03
3	204.67	16.43	5.75	3.13	1.83	1.97	8.66
4	210.93	19.14	6.63	3.72	1.72	1.88	9.45
5	199.27	15.19	5.36	3.02	1.43	1.56	8.12
6	219.68	20.82	7.06	3.96	2.57		
<b>Statistics</b>							
Min	199.27	15.19	5.36	3.02	1.43	1.56	8.12
Max	219.68	20.82	8.14	3.96	2.57	2.62	11.03
Average	210.77	18.27	6.59	3.52	1.99	2.01	9.32
Sigma	8.02	2.11	0.99	0.38	0.43	0.39	1.10
(HFE) Lot WorstCase	186.70	11.93	3.63	2.39	0.71	0.85	6.02

**Drift Calculation**

HFE1	0 kRad	25.9 kRad	51.7 kRad	77.5 kRad	107.9 kRad	24 Hours	168 Hours
<b>ON samples</b>							
2	-	46.07E-03	118.22E-03	259.49E-03	414.19E-03	376.79E-03	86.07E-03
3	-	55.98E-03	169.09E-03	315.02E-03	542.34E-03	502.55E-03	110.52E-03
4	-	47.51E-03	146.10E-03	263.72E-03	576.90E-03	526.01E-03	101.04E-03
5	-	60.82E-03	181.43E-03	326.39E-03	695.63E-03	636.62E-03	118.14E-03
6	-	43.48E-03	137.13E-03	247.67E-03	384.39E-03		
Average	-	50.77E-03	150.39E-03	282.46E-03	522.69E-03	510.49E-03	103.94E-03
Sigma	-	6.54E-03	22.55E-03	31.87E-03	113.25E-03	92.32E-03	11.97E-03
d(1/HFE) Lot WorstCase	-	70.39E-03	218.04E-03	378.08E-03	862.46E-03	787.44E-03	139.85E-03

**Test conditions : TID**  
**Parameter : Forward current transfer ratio 2 : HFE2**  
**Vce = 2V ; Ic = 1µA**  
 Unit :  
 Spec Limit Min : 10.00  
 Spec limits are represented in bold lines on the graphic.

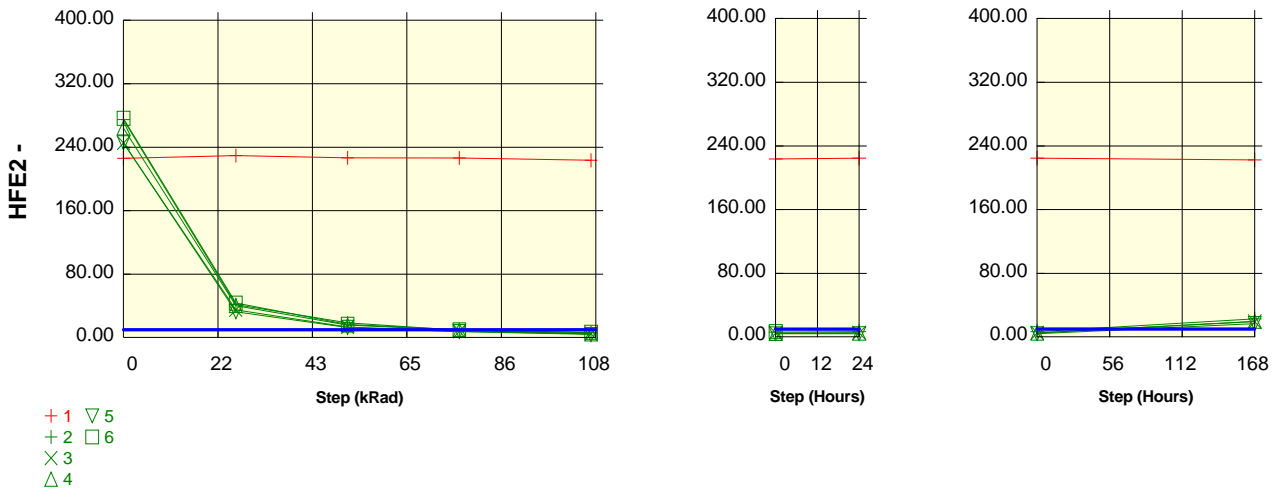

**Measurements**

HFE2	0 kRad	25.9 kRad	51.7 kRad	77.5 kRad	107.9 kRad	24 Hours	168 Hours
1_REF	226.10	229.48	226.73	226.27	223.44	224.76	222.36
<b>ON samples</b>							
2	274.79	41.45	18.57	9.34	6.10	6.59	22.79
3	245.33	34.80	13.49	7.79	4.76	5.04	19.06
4	264.08	39.98	15.63	9.23	4.51	4.88	19.60
5	245.58	32.51	12.81	7.56	3.81	4.07	16.94
6	276.43	43.39	16.59	9.77	6.49		
<b>Statistics</b>							
Min	245.33	32.51	12.81	7.56	3.81	4.07	16.94
Max	276.43	43.39	18.57	9.77	6.49	6.59	22.79
Average	261.24	38.43	15.42	8.74	5.13	5.14	19.60
Sigma	13.57	4.11	2.09	0.89	1.01	0.91	2.09
(HFE) Lot WorstCase	220.54	26.10	9.14	6.06	2.11	2.42	13.32

**Drift Calculation**

HFE2	0 kRad	25.9 kRad	51.7 kRad	77.5 kRad	107.9 kRad	24 Hours	168 Hours
<b>ON samples</b>							
2	-	20.48E-03	50.21E-03	103.46E-03	160.27E-03	148.22E-03	40.24E-03
3	-	24.66E-03	70.08E-03	124.37E-03	205.98E-03	194.28E-03	48.38E-03
4	-	21.22E-03	60.20E-03	104.61E-03	218.14E-03	201.17E-03	47.25E-03
5	-	26.69E-03	74.00E-03	128.23E-03	258.60E-03	241.40E-03	54.94E-03
6	-	19.43E-03	56.65E-03	98.71E-03	150.38E-03		
Average	-	22.50E-03	62.23E-03	111.87E-03	198.68E-03	196.27E-03	47.70E-03
Sigma	-	2.73E-03	8.72E-03	12.00E-03	39.57E-03	33.07E-03	5.22E-03
d(1/HFE) Lot WorstCase	-	30.69E-03	88.38E-03	147.89E-03	317.39E-03	295.47E-03	63.35E-03

**Test conditions : TID**  
**Parameter : Forward current transfer ratio 3 : HFE3**  
**Vce = 2V ; Ic = 100µA**  
 Unit :  
 Spec Limit Min : 10.00  
 Spec limits are represented in bold lines on the graphic.

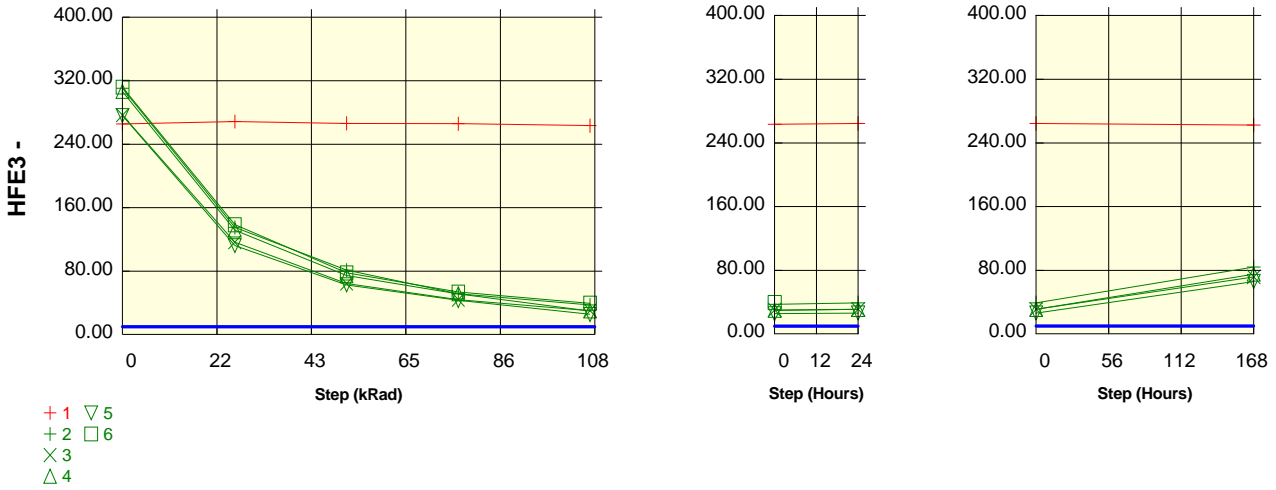

Measurements							
HFE3	0 kRad	25.9 kRad	51.7 kRad	77.5 kRad	107.9 kRad	24 Hours	168 Hours
1_REF	265.65	268.59	266.37	265.75	263.30	264.53	262.39
ON samples							
2	310.73	134.93	81.27	51.59	37.24	38.95	83.98
3	276.62	116.36	64.38	43.85	30.09	30.99	71.55
4	306.55	131.79	74.23	51.25	29.76	30.89	75.15
5	276.31	112.25	62.75	43.07	25.34	26.29	65.86
6	311.96	138.44	77.75	53.60	39.46		
Statistics							
Min	276.31	112.25	62.75	43.07	25.34	26.29	65.86
Max	311.96	138.44	81.27	53.60	39.46	38.95	83.98
Average	296.43	126.75	72.08	48.67	32.38	31.78	74.13
Sigma	16.40	10.46	7.31	4.34	5.21	4.55	6.58
(HFE) Lot WorstCase	247.22	95.37	50.13	35.66	16.76	18.13	54.40

Drift Calculation							
HFE3	0 kRad	25.9 kRad	51.7 kRad	77.5 kRad	107.9 kRad	24 Hours	168 Hours
ON samples							
2	-	4.19E-03	9.09E-03	16.16E-03	23.64E-03	22.46E-03	8.69E-03
3	-	4.98E-03	11.92E-03	19.19E-03	29.62E-03	28.65E-03	10.36E-03
4	-	4.33E-03	10.21E-03	16.25E-03	30.34E-03	29.11E-03	10.05E-03
5	-	5.29E-03	12.32E-03	19.60E-03	35.84E-03	34.42E-03	11.56E-03
6	-	4.02E-03	9.66E-03	15.45E-03	22.13E-03		
Average	-	4.56E-03	10.64E-03	17.33E-03	28.32E-03	28.66E-03	10.17E-03
Sigma	-	488.10E-06	1.27E-03	1.71E-03	4.95E-03	4.24E-03	1.02E-03
d(1/HFE) Lot WorstCase	-	6.03E-03	14.43E-03	22.47E-03	43.17E-03	41.37E-03	13.24E-03



**Test conditions : TID**  
**Parameter : Forward current transfer ratio 4 : HFE4**  
**Vce = 2V ; Ic = 1mA**  
 Unit :  
 Spec Limit Min : 10.00  
 Spec limits are represented in bold lines on the graphic.

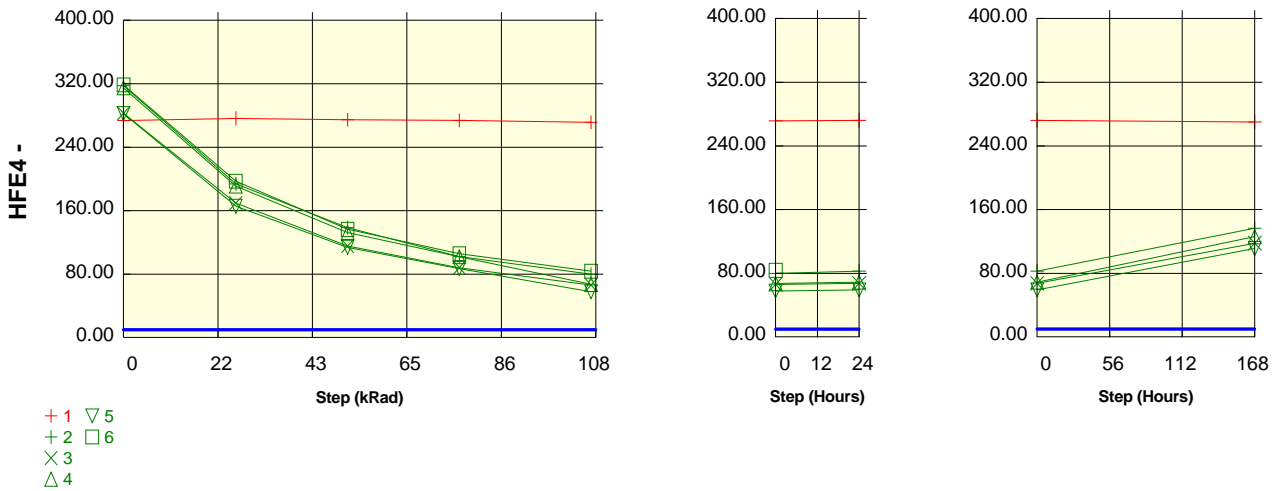

**Measurements**

HFE4	0 kRad	25.9 kRad	51.7 kRad	77.5 kRad	107.9 kRad	24 Hours	168 Hours
1_REF	273.62	276.41	274.46	273.80	271.41	272.25	270.02
<b>ON samples</b>							
2	317.49	193.85	138.60	102.22	79.91	82.64	136.42
3	282.79	169.48	115.25	88.08	66.19	67.44	117.86
4	314.86	191.00	132.26	101.76	67.00	68.82	125.96
5	282.35	165.51	113.75	87.03	57.82	59.21	111.06
6	318.54	197.14	136.38	105.64	83.61		
<b>Statistics</b>							
Min	282.35	165.51	113.75	87.03	57.82	59.21	111.06
Max	318.54	197.14	138.60	105.64	83.61	82.64	136.42
Average	303.21	183.40	127.25	96.95	70.91	69.53	122.83
Sigma	16.89	13.19	10.61	7.79	9.50	8.42	9.46
(HFE) Lot WorstCase	252.52	143.83	95.41	73.57	42.40	44.28	94.45

**Drift Calculation**

HFE4	0 kRad	25.9 kRad	51.7 kRad	77.5 kRad	107.9 kRad	24 Hours	168 Hours
<b>ON samples</b>							
2	-	2.01E-03	4.07E-03	6.63E-03	9.37E-03	8.95E-03	4.18E-03
3	-	2.36E-03	5.14E-03	7.82E-03	11.57E-03	11.29E-03	4.95E-03
4	-	2.06E-03	4.38E-03	6.65E-03	11.75E-03	11.35E-03	4.76E-03
5	-	2.50E-03	5.25E-03	7.95E-03	13.75E-03	13.35E-03	5.46E-03
6	-	1.93E-03	4.19E-03	6.33E-03	8.82E-03		
Average	-	2.17E-03	4.61E-03	7.08E-03	11.05E-03	11.24E-03	4.84E-03
Sigma	-	219.50E-06	492.11E-06	670.61E-06	1.78E-03	1.56E-03	458.36E-06
d(1/HFE) Lot WorstCase	-	2.83E-03	6.08E-03	9.09E-03	16.40E-03	15.91E-03	6.21E-03

**Test conditions : TID**  
**Parameter : Forward current transfer ratio 5 : HFE5**  
**Vce = 2V ; Ic = 10mA**  
 Unit :  
 Spec Limit Min : 10.00  
 Spec limits are represented in bold lines on the graphic.

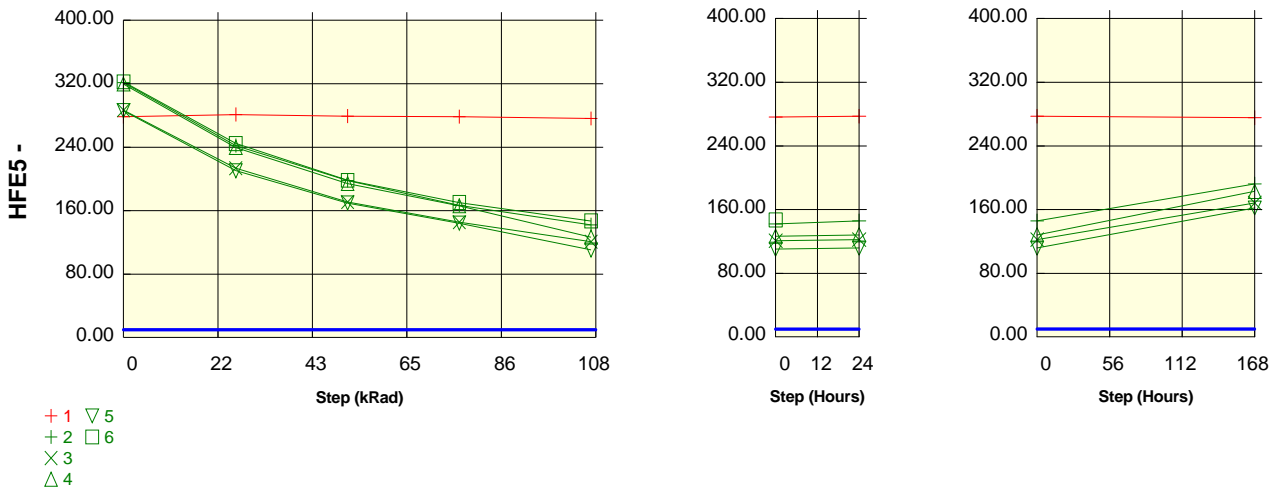

**Measurements**

HFE5	0 kRad	25.9 kRad	51.7 kRad	77.5 kRad	107.9 kRad	24 Hours	168 Hours
1_REF	278.48	281.30	279.19	278.52	276.25	277.39	275.41
<b>ON samples</b>							
2	321.43	242.04	197.93	166.56	142.18	145.68	192.41
3	286.72	213.51	170.75	145.47	120.89	122.25	168.37
4	319.67	239.64	194.14	165.99	126.53	128.31	182.81
5	286.16	210.21	169.55	144.27	110.34	111.73	162.08
6	322.40	244.56	198.15	170.23	147.04		
<b>Statistics</b>							
Min	286.16	210.21	169.55	144.27	110.34	111.73	162.08
Max	322.40	244.56	198.15	170.23	147.04	145.68	192.41
Average	307.28	229.99	186.11	158.51	129.40	126.99	176.42
Sigma	17.04	14.92	13.11	11.23	13.55	12.31	11.91
(HFE) Lot WorstCase	256.17	185.23	146.78	124.81	88.74	90.05	140.70

**Drift Calculation**

HFE5	0 kRad	25.9 kRad	51.7 kRad	77.5 kRad	107.9 kRad	24 Hours	168 Hours
<b>ON samples</b>							
2	-	1.02E-03	1.94E-03	2.89E-03	3.92E-03	3.75E-03	2.09E-03
3	-	1.20E-03	2.37E-03	3.39E-03	4.78E-03	4.69E-03	2.45E-03
4	-	1.04E-03	2.02E-03	2.90E-03	4.78E-03	4.67E-03	2.34E-03
5	-	1.26E-03	2.40E-03	3.44E-03	5.57E-03	5.46E-03	2.68E-03
6	-	987.17E-06	1.95E-03	2.77E-03	3.70E-03		
Average	-	1.10E-03	2.14E-03	3.08E-03	4.55E-03	4.64E-03	2.39E-03
Sigma	-	107.41E-06	206.31E-06	277.27E-06	672.34E-06	603.11E-06	212.00E-06
d(1/HFE) Lot WorstCase	-	1.42E-03	2.76E-03	3.91E-03	6.57E-03	6.45E-03	3.02E-03

**Test conditions : TID**  
**Parameter : Forward current transfer ratio 6 : HFE6**  
**Vce = 2V ; Ic = 100mA**  
 Unit :  
 Spec Limit Min : 80.00  
 Spec limits are represented in bold lines on the graphic.

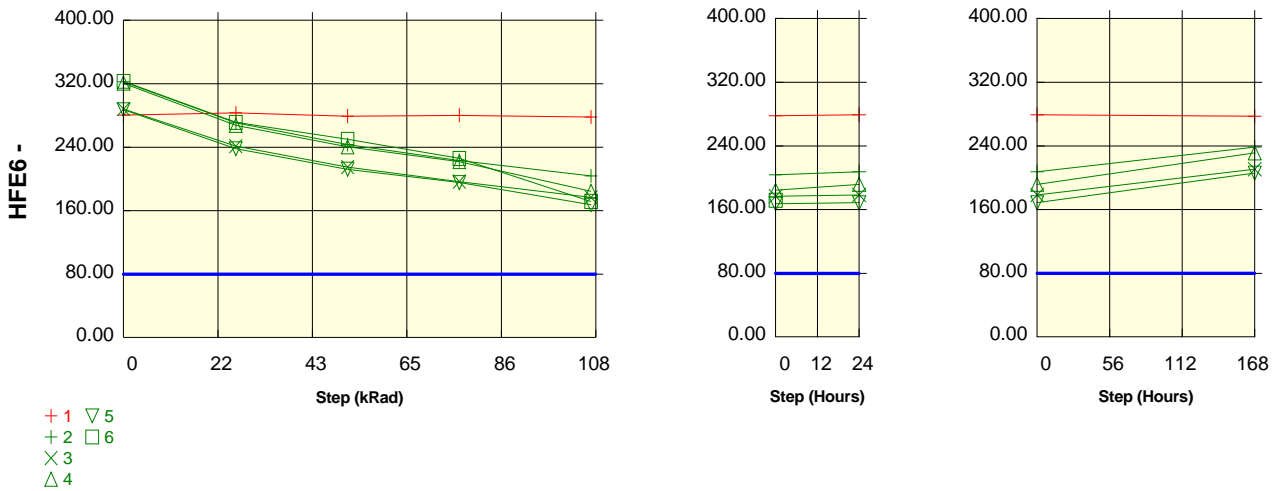

**Measurements**

HFE6	0 kRad	25.9 kRad	51.7 kRad	77.5 kRad	107.9 kRad	24 Hours	168 Hours
1_REF	280.31	283.07	279.19	280.21	278.06	279.21	277.36
<b>ON samples</b>							
2	322.33	270.87	243.29	223.16	203.81	207.62	238.35
3	288.04	241.25	214.92	196.62	176.63	178.35	210.73
4	320.82	267.50	240.43	221.95	184.39	191.61	231.19
5	287.44	238.15	212.23	195.33	167.28	168.57	205.84
6	323.17	271.25	249.85	225.84	171.68		
<b>Statistics</b>							
Min	287.44	238.15	212.23	195.33	167.28	168.57	205.84
Max	323.17	271.25	249.85	225.84	203.81	207.62	238.35
Average	308.36	257.80	232.14	212.58	180.76	186.54	221.52
Sigma	16.85	14.87	15.49	13.62	12.85	14.66	13.59
(HFE) Lot WorstCase	257.80	213.18	185.67	171.71	142.21	142.55	180.74

**Drift Calculation**

HFE6	0 kRad	25.9 kRad	51.7 kRad	77.5 kRad	107.9 kRad	24 Hours	168 Hours
<b>ON samples</b>							
2	-	589.40E-06	1.01E-03	1.38E-03	1.80E-03	1.71E-03	1.09E-03
3	-	673.44E-06	1.18E-03	1.61E-03	2.19E-03	2.14E-03	1.27E-03
4	-	621.39E-06	1.04E-03	1.39E-03	2.31E-03	2.10E-03	1.21E-03
5	-	720.11E-06	1.23E-03	1.64E-03	2.50E-03	2.45E-03	1.38E-03
6	-	592.28E-06	908.06E-06	1.33E-03	2.73E-03		
Average	-	639.32E-06	1.07E-03	1.47E-03	2.31E-03	2.10E-03	1.24E-03
Sigma	-	50.43E-06	118.03E-06	129.21E-06	310.73E-06	262.16E-06	103.77E-06
d(1/HFE) Lot WorstCase	-	790.62E-06	1.43E-03	1.86E-03	3.24E-03	2.89E-03	1.55E-03

**Test conditions : TID**  
**Parameter : Forward current transfer ratio 7 : HFE7**  
**Vce = 2V ; Ic = 500mA**  
 Unit :  
 Spec Limit Min : 10.00  
 Spec limits are represented in bold lines on the graphic.

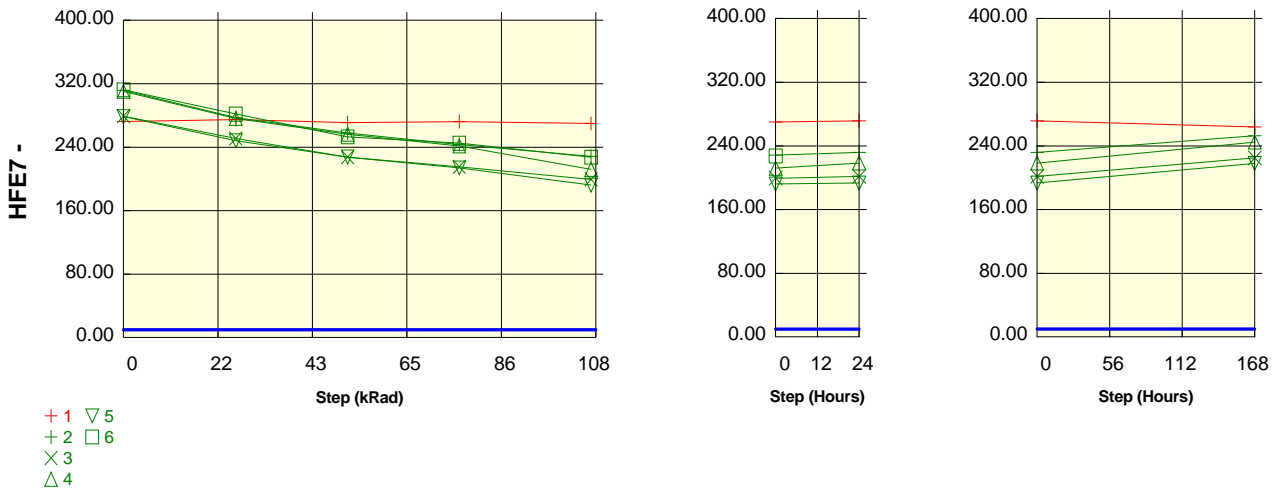

**Measurements**

HFE7	0 kRad	25.9 kRad	51.7 kRad	77.5 kRad	107.9 kRad	24 Hours	168 Hours
1_REF	272.30	274.87	271.05	272.22	270.12	271.52	263.84
<b>ON samples</b>							
2	311.49	277.44	257.92	243.44	228.50	232.04	252.79
3	279.21	251.03	227.48	215.21	199.39	201.62	224.87
4	310.30	276.33	256.17	241.56	211.99	218.51	244.77
5	278.59	248.22	227.53	213.86	192.21	193.38	217.97
6	312.25	281.70	253.08	244.88	227.37		
<b>Statistics</b>							
Min	278.59	248.22	227.48	213.86	192.21	193.38	217.97
Max	312.25	281.70	257.92	244.88	228.50	232.04	252.79
Average	298.37	266.94	244.44	231.79	211.89	211.39	235.10
Sigma	15.91	14.28	13.91	14.13	14.55	14.98	14.18
(HFE) Lot WorstCase	250.64	224.10	202.70	189.39	168.23	166.46	192.55

**Drift Calculation**

HFE7	0 kRad	25.9 kRad	51.7 kRad	77.5 kRad	107.9 kRad	24 Hours	168 Hours
<b>ON samples</b>							
2	-	394.03E-06	666.81E-06	897.46E-06	1.17E-03	1.10E-03	745.46E-06
3	-	402.16E-06	814.51E-06	1.07E-03	1.43E-03	1.38E-03	865.44E-06
4	-	396.18E-06	680.96E-06	917.08E-06	1.49E-03	1.35E-03	862.77E-06
5	-	439.07E-06	805.46E-06	1.09E-03	1.61E-03	1.58E-03	998.32E-06
6	-	347.33E-06	748.87E-06	881.13E-06	1.20E-03		
Average	-	395.75E-06	743.32E-06	969.43E-06	1.38E-03	1.35E-03	868.00E-06
Sigma	-	29.21E-06	61.16E-06	87.81E-06	173.25E-06	171.28E-06	89.49E-06
d(1/HFE) Lot WorstCase	-	483.38E-06	926.80E-06	1.23E-03	1.90E-03	1.87E-03	1.14E-03

**Test conditions : TID**  
**Parameter : Forward current transfer ratio 8 : HFE8**  
**Vce = 2V ; Ic = 1A**  
 Unit :  
 Spec Limit Min : 160.00  
 Spec Limit Max : 400.00  
 Spec limits are represented in bold lines on the graphic.

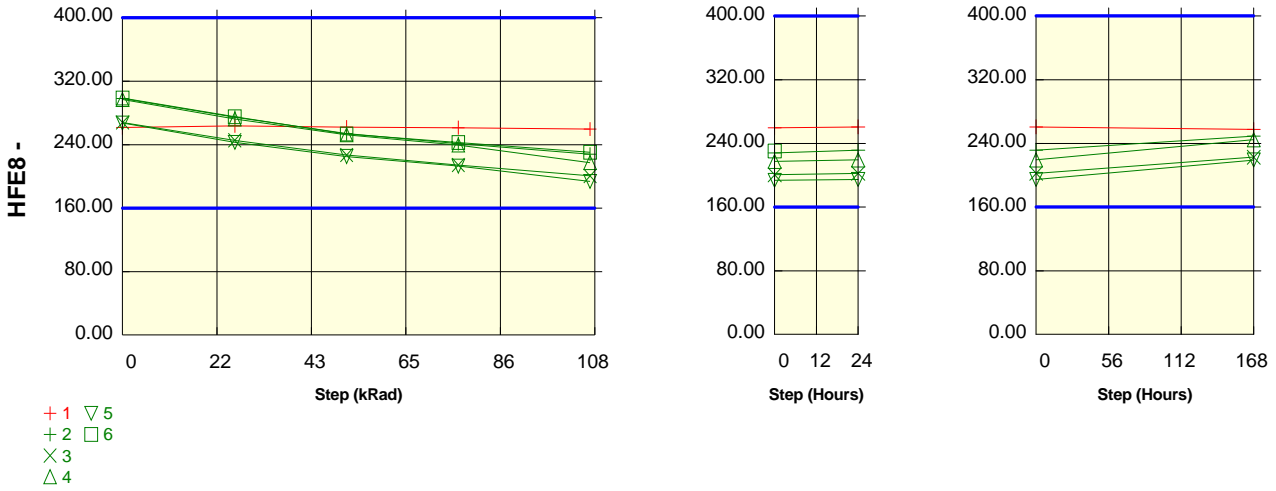

**Measurements**

HFE8	0 kRad	25.9 kRad	51.7 kRad	77.5 kRad	107.9 kRad	24 Hours	168 Hours
<b>1_REF</b>	261.58	263.95	262.17	261.45	259.64	260.78	257.61
<b>ON samples</b>							
<b>2</b>	298.06	274.51	253.97	241.24	228.09	231.53	249.36
<b>3</b>	267.90	245.53	227.06	214.30	200.48	202.32	222.73
<b>4</b>	296.97	272.52	252.36	239.55	217.46	219.27	244.58
<b>5</b>	267.29	242.89	225.03	212.98	193.64	194.79	219.17
<b>6</b>	298.72	275.21	253.32	242.61	230.52		
<b>Statistics</b>							
<b>Min</b>	267.29	242.89	225.03	212.98	193.64	194.79	219.17
<b>Max</b>	298.72	275.21	253.97	242.61	230.52	231.53	249.36
<b>Average</b>	285.79	262.13	242.35	230.14	214.04	211.98	233.96
<b>Sigma</b>	14.87	14.68	13.34	13.51	14.70	14.36	13.18
<b>(HFE) Lot WorstCase</b>	241.19	218.08	202.34	189.61	169.93	168.91	194.42

**Drift Calculation**

HFE8	0 kRad	25.9 kRad	51.7 kRad	77.5 kRad	107.9 kRad	24 Hours	168 Hours
<b>ON samples</b>							
<b>2</b>	-	287.85E-06	582.46E-06	790.20E-06	1.03E-03	963.98E-06	655.21E-06
<b>3</b>	-	340.08E-06	671.44E-06	933.60E-06	1.26E-03	1.21E-03	757.03E-06
<b>4</b>	-	302.05E-06	595.32E-06	807.09E-06	1.23E-03	1.19E-03	721.33E-06
<b>5</b>	-	375.91E-06	702.67E-06	954.05E-06	1.42E-03	1.39E-03	821.44E-06
<b>6</b>	-	286.04E-06	600.07E-06	774.26E-06	990.45E-06		
<b>Average</b>	-	318.39E-06	630.39E-06	851.84E-06	1.19E-03	1.19E-03	738.75E-06
<b>Sigma</b>	-	34.71E-06	47.66E-06	76.10E-06	158.64E-06	152.11E-06	60.11E-06
<b>d(1/HFE) Lot WorstCase</b>	-	422.53E-06	773.36E-06	1.08E-03	1.66E-03	1.65E-03	919.09E-06

**Test conditions : TID**  
**Parameter : Forward current transfer ratio 9 : HFE9**  
**Vce = 2V ; Ic = 2A**  
 Unit :  
 Spec Limit Min : 10.00  
 Spec limits are represented in bold lines on the graphic.

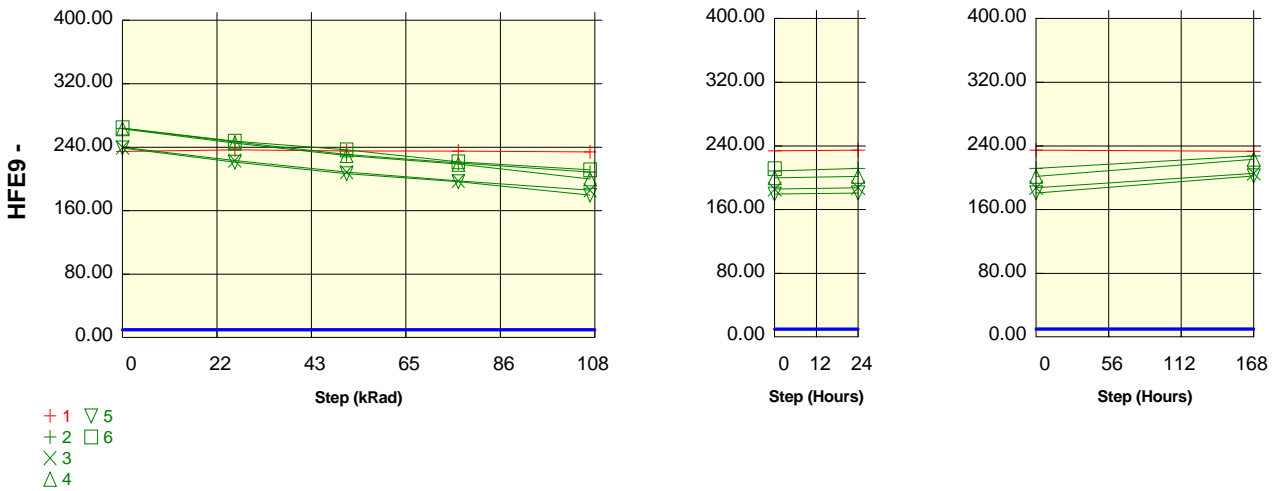

**Measurements**

HFE9	0 kRad	25.9 kRad	51.7 kRad	77.5 kRad	107.9 kRad	24 Hours	168 Hours
1_REF	234.65	236.57	235.47	235.16	233.91	234.65	233.19
<b>ON samples</b>							
2	263.64	246.79	230.70	219.91	208.62	211.82	227.30
3	239.71	223.23	208.58	197.47	185.62	187.51	205.56
4	263.02	245.05	229.36	218.56	199.97	201.67	223.20
5	238.93	221.10	206.52	196.45	179.42	181.04	202.22
6	264.25	247.45	236.59	221.42	211.32		
<b>Statistics</b>							
Min	238.93	221.10	206.52	196.45	179.42	181.04	202.22
Max	264.25	247.45	236.59	221.42	211.32	211.82	227.30
Average	253.91	236.73	222.35	210.76	196.99	195.51	214.57
Sigma	11.92	11.93	12.34	11.31	12.55	12.01	10.84
(HFE) Lot WorstCase	218.15	200.93	185.32	176.82	159.34	159.47	182.05

**Drift Calculation**

HFE9	0 kRad	25.9 kRad	51.7 kRad	77.5 kRad	107.9 kRad	24 Hours	168 Hours
<b>ON samples</b>							
2	-	258.86E-06	541.50E-06	754.17E-06	1.00E-03	927.95E-06	606.47E-06
3	-	307.94E-06	622.69E-06	892.47E-06	1.22E-03	1.16E-03	693.03E-06
4	-	278.73E-06	557.87E-06	773.31E-06	1.20E-03	1.16E-03	678.20E-06
5	-	337.52E-06	656.72E-06	905.10E-06	1.39E-03	1.34E-03	759.66E-06
6	-	256.92E-06	442.49E-06	732.07E-06	947.94E-06		
Average	-	287.99E-06	564.25E-06	811.42E-06	1.15E-03	1.15E-03	684.34E-06
Sigma	-	30.82E-06	73.96E-06	72.62E-06	159.15E-06	145.64E-06	54.43E-06
d(1/HFE) Lot WorstCase	-	380.47E-06	786.13E-06	1.03E-03	1.63E-03	1.58E-03	847.62E-06

**Test conditions : TID**  
**Parameter : Collector emitter saturation voltage 1 : VCE(SAT)1**  
**Ic = 2A ; Ib = 100mA**  
 Unit : V  
 Spec Limit Max : 400.0E-03  
 Spec limits are represented in bold lines on the graphic.

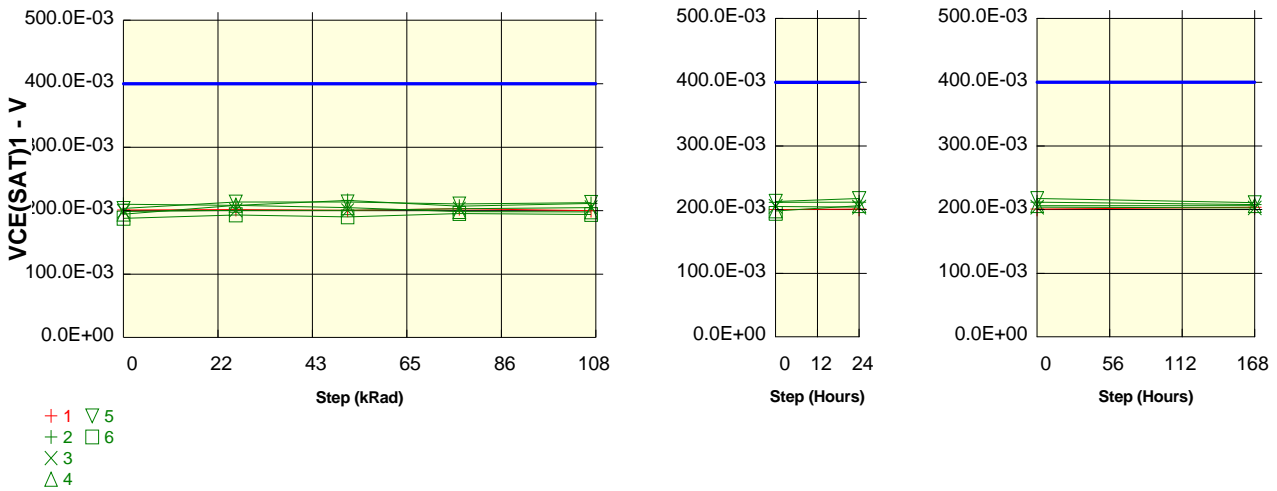

**Measurements**

VCE(SAT)1	0 kRad	25.9 kRad	51.7 kRad	77.5 kRad	107.9 kRad	24 Hours	168 Hours
<b>1_REF</b>	201.1E-03	201.8E-03	200.4E-03	203.2E-03	200.3E-03	201.1E-03	203.4E-03
<b>ON samples</b>							
2	210.0E-03	208.2E-03	216.0E-03	206.9E-03	211.2E-03	211.8E-03	208.1E-03
3	199.0E-03	200.7E-03	200.6E-03	203.0E-03	205.0E-03	203.8E-03	202.8E-03
4	194.4E-03	208.5E-03	204.6E-03	198.4E-03	197.8E-03	206.4E-03	206.3E-03
5	203.6E-03	213.6E-03	213.7E-03	210.4E-03	212.8E-03	217.3E-03	210.8E-03
6	188.1E-03	193.4E-03	190.2E-03	195.5E-03	194.0E-03		
<b>Statistics</b>							
<b>Min</b>	188.1E-03	193.4E-03	190.2E-03	195.5E-03	194.0E-03	203.8E-03	202.8E-03
<b>Max</b>	210.0E-03	213.6E-03	216.0E-03	210.4E-03	212.8E-03	217.3E-03	210.8E-03
<b>Average</b>	199.0E-03	204.9E-03	205.0E-03	202.8E-03	204.2E-03	209.8E-03	207.0E-03
<b>Sigma</b>	7.5E-03	7.1E-03	9.3E-03	5.4E-03	7.3E-03	5.2E-03	2.9E-03
<b>(VCE) Lot WorstCase</b>	221.6E-03	226.1E-03	233.0E-03	219.1E-03	226.2E-03	225.5E-03	215.8E-03

**Drift Calculation**

VCE(SAT)1	0 kRad	25.9 kRad	51.7 kRad	77.5 kRad	107.9 kRad	24 Hours	168 Hours
<b>ON samples</b>							
2	-	-1.84E-03	5.96E-03	-3.16E-03	1.16E-03	1.80E-03	-1.96E-03
3	-	1.72E-03	1.60E-03	4.08E-03	6.04E-03	4.84E-03	3.84E-03
4	-	14.04E-03	10.20E-03	3.96E-03	3.36E-03	11.92E-03	11.88E-03
5	-	10.00E-03	10.08E-03	6.76E-03	9.24E-03	13.72E-03	7.24E-03
6	-	5.28E-03	2.08E-03	7.44E-03	5.92E-03		
<b>Average</b>	-	5.84E-03	5.98E-03	3.82E-03	5.14E-03	8.07E-03	5.25E-03
<b>Sigma</b>	-	5.67E-03	3.72E-03	3.76E-03	2.73E-03	4.91E-03	5.05E-03
<b>d(VCE) Lot WorstCase</b>	-	22.85E-03	17.13E-03	15.09E-03	13.33E-03	22.80E-03	20.39E-03

**Test conditions : TID**  
**Parameter : Collector emitter saturation voltage 2 : VCE(SAT)2**  
**Ic = 3A ; Ib = 150mA**  
 Unit : V  
 Spec Limit Max : 500.0E-03  
 Spec limits are represented in bold lines on the graphic.

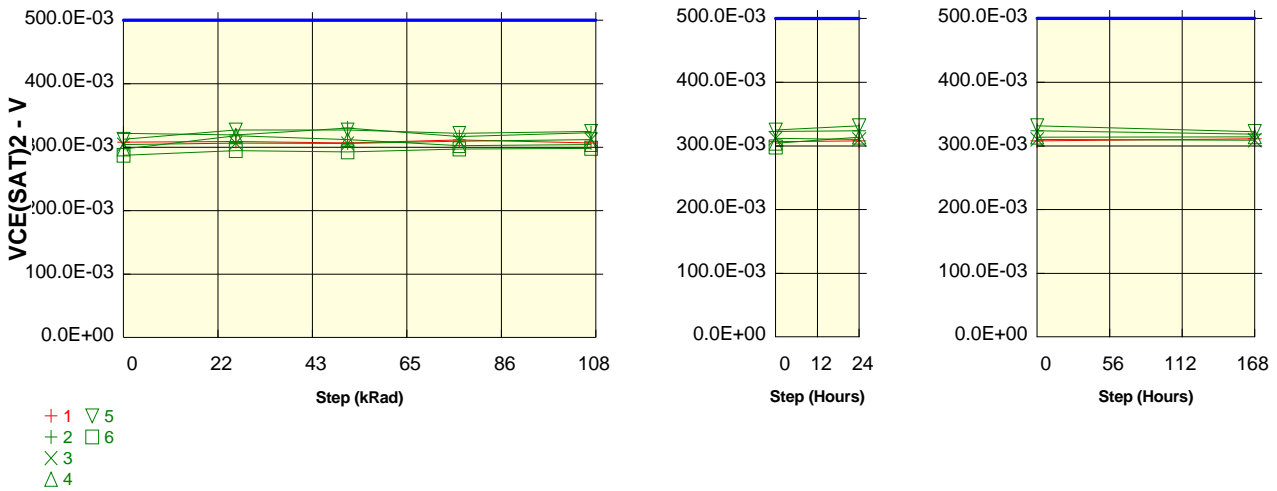

**Measurements**

VCE(SAT)2	0 kRad	25.9 kRad	51.7 kRad	77.5 kRad	107.9 kRad	24 Hours	168 Hours
<b>1_REF</b>	307.9E-03	309.1E-03	306.9E-03	311.3E-03	306.7E-03	308.0E-03	311.2E-03
<b>ON samples</b>							
<b>2</b>	322.1E-03	319.2E-03	330.4E-03	316.6E-03	322.8E-03	323.8E-03	318.3E-03
<b>3</b>	304.2E-03	306.2E-03	305.9E-03	309.4E-03	312.0E-03	310.2E-03	309.0E-03
<b>4</b>	297.3E-03	317.9E-03	311.9E-03	302.4E-03	304.2E-03	313.8E-03	314.1E-03
<b>5</b>	312.4E-03	327.1E-03	327.2E-03	321.7E-03	325.0E-03	331.7E-03	322.6E-03
<b>6</b>	287.2E-03	294.5E-03	292.6E-03	297.4E-03	298.2E-03		
<b>Statistics</b>							
<b>Min</b>	287.2E-03	294.5E-03	292.6E-03	297.4E-03	298.2E-03	310.2E-03	309.0E-03
<b>Max</b>	322.1E-03	327.1E-03	330.4E-03	321.7E-03	325.0E-03	331.7E-03	322.6E-03
<b>Average</b>	304.6E-03	313.0E-03	313.6E-03	309.5E-03	312.5E-03	319.9E-03	316.0E-03
<b>Sigma</b>	12.0E-03	11.4E-03	13.9E-03	8.9E-03	10.3E-03	8.4E-03	5.0E-03
<b>(VCE) Lot WorstCase</b>	340.7E-03	347.2E-03	355.4E-03	336.2E-03	343.5E-03	345.2E-03	331.1E-03

**Drift Calculation**

VCE(SAT)2	0 kRad	25.9 kRad	51.7 kRad	77.5 kRad	107.9 kRad	24 Hours	168 Hours
<b>ON samples</b>							
<b>2</b>	-	-2.92E-03	8.24E-03	-5.52E-03	719.99E-06	1.72E-03	-3.80E-03
<b>3</b>	-	2.00E-03	1.64E-03	5.16E-03	7.80E-03	5.96E-03	4.76E-03
<b>4</b>	-	20.64E-03	14.60E-03	5.12E-03	6.96E-03	16.56E-03	16.80E-03
<b>5</b>	-	14.76E-03	14.88E-03	9.36E-03	12.60E-03	19.32E-03	10.20E-03
<b>6</b>	-	7.32E-03	5.36E-03	10.20E-03	11.04E-03		
<b>Average</b>	-	8.36E-03	8.94E-03	4.86E-03	7.82E-03	10.89E-03	6.99E-03
<b>Sigma</b>	-	8.49E-03	5.18E-03	5.60E-03	4.11E-03	7.27E-03	7.55E-03
<b>d(VCE) Lot WorstCase</b>	-	33.83E-03	24.47E-03	21.66E-03	20.15E-03	32.71E-03	29.64E-03



**Test conditions : TID**  
**Parameter : Base emitter saturation voltage : VBE(SAT)**  
**Ic = 2A ; Ib = 100mA**  
 Unit : V  
 Spec Limit Max : 1.2E+00  
 Spec limits are represented in bold lines on the graphic.

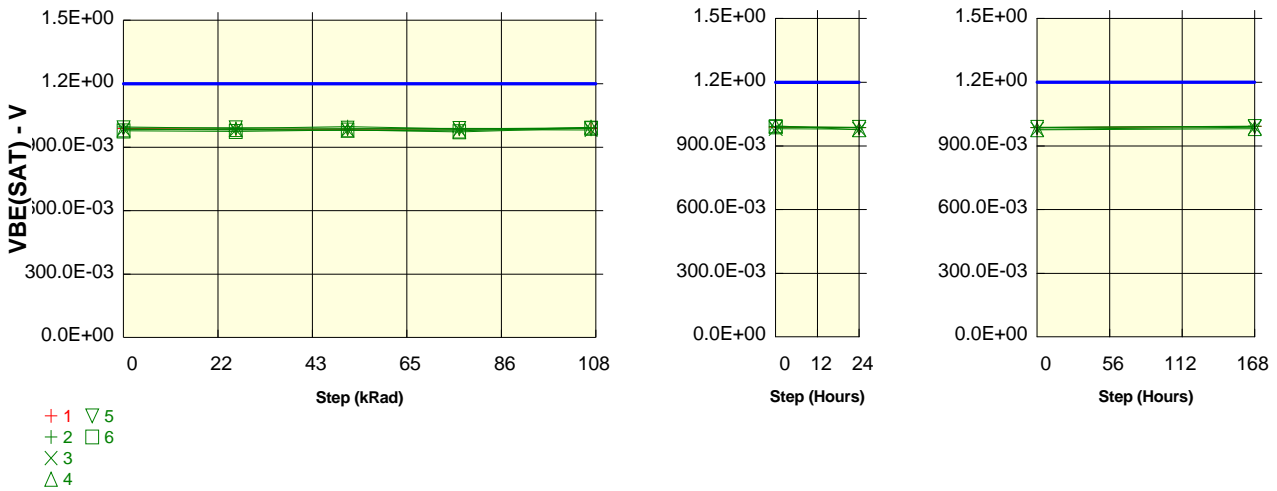

**Measurements**

VBE(SAT)	0 kRad	25.9 kRad	51.7 kRad	77.5 kRad	107.9 kRad	24 Hours	168 Hours
<b>1_REF</b>	988.4E-03	984.9E-03	985.1E-03	986.1E-03	988.1E-03	986.2E-03	991.2E-03
<b>ON samples</b>							
<b>2</b>	995.6E-03	989.2E-03	996.7E-03	986.5E-03	991.2E-03	987.0E-03	992.6E-03
<b>3</b>	985.1E-03	982.0E-03	981.4E-03	983.2E-03	981.9E-03	978.2E-03	987.5E-03
<b>4</b>	982.2E-03	983.6E-03	980.5E-03	977.1E-03	994.2E-03	975.8E-03	982.0E-03
<b>5</b>	991.1E-03	991.7E-03	989.8E-03	989.0E-03	987.9E-03	987.8E-03	992.1E-03
<b>6</b>	977.0E-03	974.3E-03	981.5E-03	972.7E-03	990.1E-03		
<b>Statistics</b>							
<b>Min</b>	977.0E-03	974.3E-03	980.5E-03	972.7E-03	981.9E-03	975.8E-03	982.0E-03
<b>Max</b>	995.6E-03	991.7E-03	996.7E-03	989.0E-03	994.2E-03	987.8E-03	992.6E-03
<b>Average</b>	986.2E-03	984.1E-03	986.0E-03	981.7E-03	989.1E-03	982.2E-03	988.5E-03
<b>Sigma</b>	6.5E-03	6.1E-03	6.3E-03	6.0E-03	4.1E-03	5.3E-03	4.3E-03
<b>(VBE) Lot WorstCase</b>	1.0E+00	1.0E+00	1.0E+00	999.7E-03	1.0E+00	998.0E-03	1.0E+00

**Drift Calculation**

VBE(SAT)	0 kRad	25.9 kRad	51.7 kRad	77.5 kRad	107.9 kRad	24 Hours	168 Hours
<b>ON samples</b>							
<b>2</b>	-	-6.36E-03	1.08E-03	-9.12E-03	-4.36E-03	-8.56E-03	-3.00E-03
<b>3</b>	-	-3.12E-03	-3.72E-03	-1.88E-03	-3.20E-03	-6.88E-03	2.44E-03
<b>4</b>	-	1.32E-03	-1.76E-03	-5.16E-03	11.96E-03	-6.40E-03	-279.94E-06
<b>5</b>	-	560.06E-06	-1.36E-03	-2.16E-03	-3.20E-03	-3.32E-03	960.01E-06
<b>6</b>	-	-2.72E-03	4.52E-03	-4.28E-03	13.08E-03		
<b>Average</b>	-	-2.06E-03	-247.95E-06	-4.52E-03	2.86E-03	-6.29E-03	30.03E-06
<b>Sigma</b>	-	2.77E-03	2.83E-03	2.61E-03	7.91E-03	1.89E-03	2.00E-03
<b>d(VBE) Lot WorstCase</b>	-	6.24E-03	8.25E-03	3.32E-03	26.59E-03	-610.91E-06	6.02E-03

**Test conditions : TID**  
**Parameter : Base-Emitter Voltage : VBE1**  
**Vce = 2V ; Ic = 100nA**  
 Unit : V  
 Spec Limit Max : 1.5E+00  
 Spec limits are represented in bold lines on the graphic.

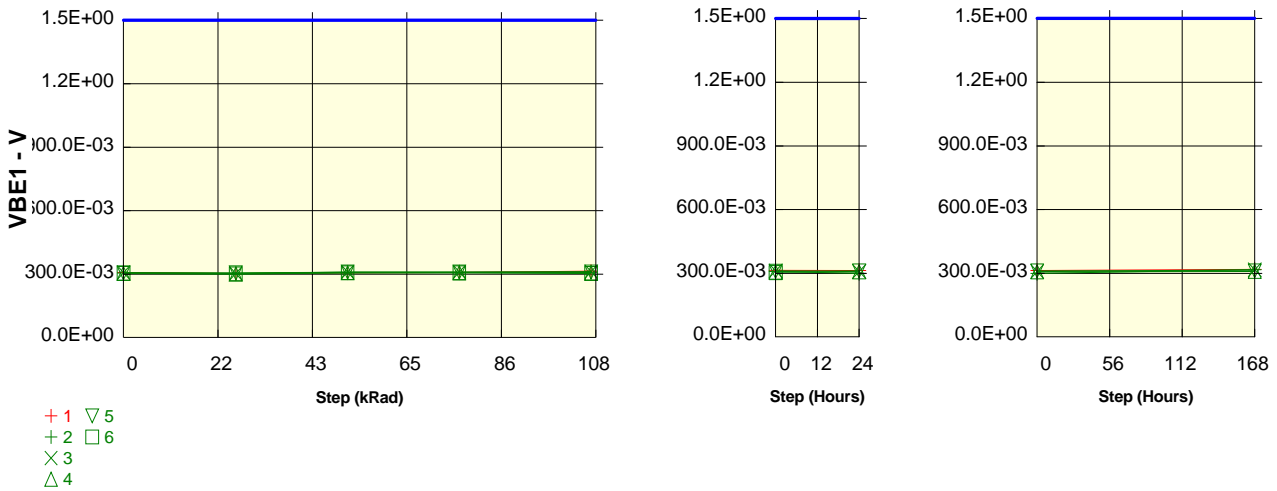

**Measurements**

VBE1	0 kRad	25.9 kRad	51.7 kRad	77.5 kRad	107.9 kRad	24 Hours	168 Hours
<b>1_REF</b>	307.4E-03	301.9E-03	306.7E-03	307.9E-03	313.6E-03	312.5E-03	317.6E-03
<b>ON samples</b>							
2	304.9E-03	302.3E-03	306.5E-03	306.2E-03	309.3E-03	299.5E-03	316.8E-03
3	306.8E-03	302.8E-03	309.9E-03	310.2E-03	311.8E-03	308.2E-03	316.9E-03
4	303.3E-03	300.2E-03	306.4E-03	307.2E-03	305.4E-03	306.8E-03	308.5E-03
5	305.8E-03	305.7E-03	309.3E-03	309.5E-03	309.4E-03	311.2E-03	311.2E-03
6	302.8E-03	300.9E-03	306.2E-03	305.7E-03	302.9E-03		
<b>Statistics</b>							
<b>Min</b>	302.8E-03	300.2E-03	306.2E-03	305.7E-03	302.9E-03	299.5E-03	308.5E-03
<b>Max</b>	306.8E-03	305.7E-03	309.9E-03	310.2E-03	311.8E-03	311.2E-03	316.9E-03
<b>Average</b>	304.7E-03	302.4E-03	307.7E-03	307.7E-03	307.7E-03	306.4E-03	313.4E-03
<b>Sigma</b>	1.5E-03	1.9E-03	1.6E-03	1.8E-03	3.2E-03	4.3E-03	3.6E-03
<b>(VBE) Lot WorstCase</b>	309.2E-03	308.1E-03	312.5E-03	313.2E-03	317.3E-03	319.3E-03	324.3E-03

**Drift Calculation**

VBE1	0 kRad	25.9 kRad	51.7 kRad	77.5 kRad	107.9 kRad	24 Hours	168 Hours
<b>ON samples</b>							
2	-	-2.58E-03	1.66E-03	1.33E-03	4.42E-03	-5.32E-03	11.99E-03
3	-	-4.02E-03	3.09E-03	3.39E-03	4.94E-03	1.31E-03	10.08E-03
4	-	-3.18E-03	3.04E-03	3.84E-03	2.10E-03	3.47E-03	5.18E-03
5	-	-86.55E-06	3.53E-03	3.69E-03	3.57E-03	5.42E-03	5.40E-03
6	-	-1.90E-03	3.41E-03	2.87E-03	100.28E-06		
<b>Average</b>	-	-2.35E-03	2.95E-03	3.02E-03	3.02E-03	1.22E-03	8.16E-03
<b>Sigma</b>	-	1.33E-03	667.81E-06	907.65E-06	1.75E-03	4.04E-03	2.95E-03
<b>d(VBE) Lot WorstCase</b>	-	1.64E-03	4.95E-03	5.75E-03	8.27E-03	13.35E-03	17.02E-03

**Test conditions : TID**  
**Parameter : Base-Emitter Voltage : VBE2**  
**Vce = 2V ; Ic = 1µA**  
 Unit : V  
 Spec Limit Max : 1.5E+00  
 Spec limits are represented in bold lines on the graphic.

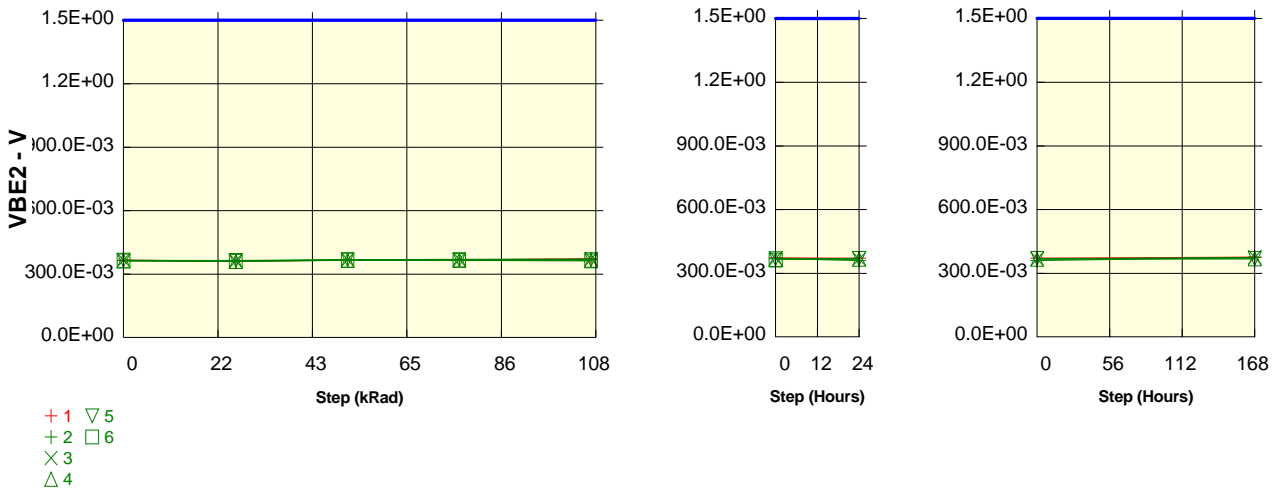

**Measurements**

VBE2	0 kRad	25.9 kRad	51.7 kRad	77.5 kRad	107.9 kRad	24 Hours	168 Hours
<b>1_REF</b>	366.7E-03	361.4E-03	366.2E-03	367.3E-03	372.6E-03	371.4E-03	376.1E-03
<b>ON samples</b>							
2	364.0E-03	361.5E-03	365.6E-03	365.4E-03	368.4E-03	359.1E-03	375.1E-03
3	366.1E-03	362.3E-03	369.1E-03	369.5E-03	370.9E-03	367.3E-03	375.4E-03
4	362.6E-03	359.5E-03	365.5E-03	366.4E-03	364.8E-03	365.9E-03	367.4E-03
5	365.2E-03	365.0E-03	368.5E-03	368.8E-03	368.7E-03	370.2E-03	370.1E-03
6	362.1E-03	360.3E-03	365.4E-03	365.0E-03	362.4E-03		
<b>Statistics</b>							
Min	362.1E-03	359.5E-03	365.4E-03	365.0E-03	362.4E-03	359.1E-03	367.4E-03
Max	366.1E-03	365.0E-03	369.1E-03	369.5E-03	370.9E-03	370.2E-03	375.4E-03
Average	364.0E-03	361.7E-03	366.8E-03	367.0E-03	367.0E-03	365.6E-03	372.0E-03
Sigma	1.5E-03	1.9E-03	1.6E-03	1.8E-03	3.0E-03	4.1E-03	3.4E-03
<b>(VBE) Lot WorstCase</b>	368.5E-03	367.4E-03	371.6E-03	372.4E-03	376.1E-03	377.9E-03	382.2E-03

**Drift Calculation**

VBE2	0 kRad	25.9 kRad	51.7 kRad	77.5 kRad	107.9 kRad	24 Hours	168 Hours
<b>ON samples</b>							
2	-	-2.49E-03	1.60E-03	1.39E-03	4.39E-03	-4.98E-03	11.10E-03
3	-	-3.84E-03	2.93E-03	3.35E-03	4.75E-03	1.18E-03	9.32E-03
4	-	-3.08E-03	2.91E-03	3.80E-03	2.15E-03	3.26E-03	4.81E-03
5	-	-161.11E-06	3.31E-03	3.57E-03	3.49E-03	5.00E-03	4.91E-03
6	-	-1.88E-03	3.22E-03	2.83E-03	296.50E-06		
Average	-	-2.29E-03	2.80E-03	2.99E-03	3.02E-03	1.12E-03	7.54E-03
Sigma	-	1.25E-03	616.31E-06	861.88E-06	1.63E-03	3.77E-03	2.75E-03
<b>d(VBE) Lot WorstCase</b>	-	1.45E-03	4.64E-03	5.57E-03	7.90E-03	12.42E-03	15.77E-03

**Test conditions : TID**  
**Parameter : Base-Emitter Voltage : VBE3**  
**Vce = 2V ; Ic = 100µA**  
 Unit : V  
 Spec Limit Max : 1.5E+00  
 Spec limits are represented in bold lines on the graphic.

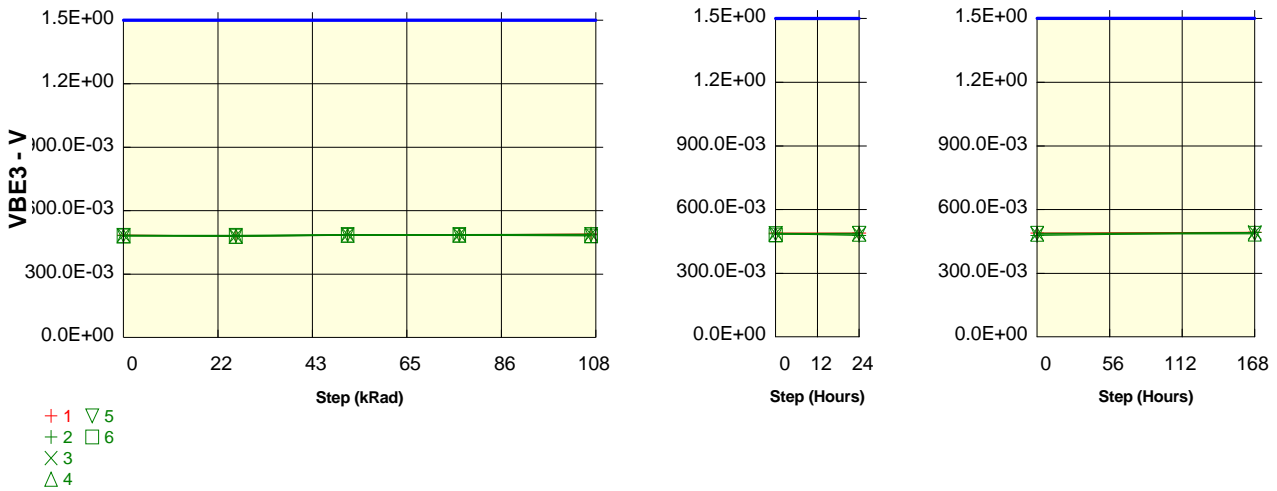

**Measurements**

VBE3	0 kRad	25.9 kRad	51.7 kRad	77.5 kRad	107.9 kRad	24 Hours	168 Hours
<b>1_REF</b>	484.8E-03	480.5E-03	484.5E-03	485.6E-03	490.1E-03	489.1E-03	493.2E-03
<b>ON samples</b>							
2	482.0E-03	480.1E-03	483.7E-03	483.4E-03	486.0E-03	478.1E-03	491.9E-03
3	484.2E-03	481.0E-03	487.1E-03	487.3E-03	488.4E-03	485.6E-03	492.5E-03
4	480.8E-03	478.4E-03	483.6E-03	484.3E-03	482.8E-03	483.9E-03	485.2E-03
5	483.4E-03	483.5E-03	486.6E-03	486.7E-03	486.5E-03	488.0E-03	487.9E-03
6	480.4E-03	478.9E-03	483.4E-03	483.0E-03	480.9E-03		
<b>Statistics</b>							
Min	480.4E-03	478.4E-03	483.4E-03	483.0E-03	480.9E-03	478.1E-03	485.2E-03
Max	484.2E-03	483.5E-03	487.1E-03	487.3E-03	488.4E-03	488.0E-03	492.5E-03
Average	482.2E-03	480.4E-03	484.9E-03	484.9E-03	484.9E-03	483.9E-03	489.4E-03
Sigma	1.5E-03	1.8E-03	1.6E-03	1.7E-03	2.7E-03	3.7E-03	3.0E-03
<b>(VBE) Lot WorstCase</b>	486.6E-03	485.8E-03	489.7E-03	490.1E-03	493.1E-03	494.9E-03	498.3E-03

**Drift Calculation**

VBE3	0 kRad	25.9 kRad	51.7 kRad	77.5 kRad	107.9 kRad	24 Hours	168 Hours
<b>ON samples</b>							
2	-	-1.95E-03	1.63E-03	1.41E-03	3.96E-03	-3.97E-03	9.82E-03
3	-	-3.20E-03	2.81E-03	3.06E-03	4.20E-03	1.33E-03	8.25E-03
4	-	-2.44E-03	2.76E-03	3.43E-03	1.98E-03	3.05E-03	4.42E-03
5	-	141.38E-06	3.17E-03	3.30E-03	3.15E-03	4.64E-03	4.52E-03
6	-	-1.50E-03	3.03E-03	2.63E-03	484.17E-06		
Average	-	-1.79E-03	2.68E-03	2.77E-03	2.76E-03	1.26E-03	6.75E-03
Sigma	-	1.12E-03	545.81E-06	731.81E-06	1.38E-03	3.24E-03	2.35E-03
<b>d(VBE) Lot WorstCase</b>	-	1.56E-03	4.32E-03	4.96E-03	6.88E-03	10.99E-03	13.80E-03

Test conditions : TID

Parameter : Base-Emitter Voltage : VBE4

Vce = 2V ; Ic = 1mA

Unit : V

Spec Limit Max : 1.5E+00

Spec limits are represented in bold lines on the graphic.

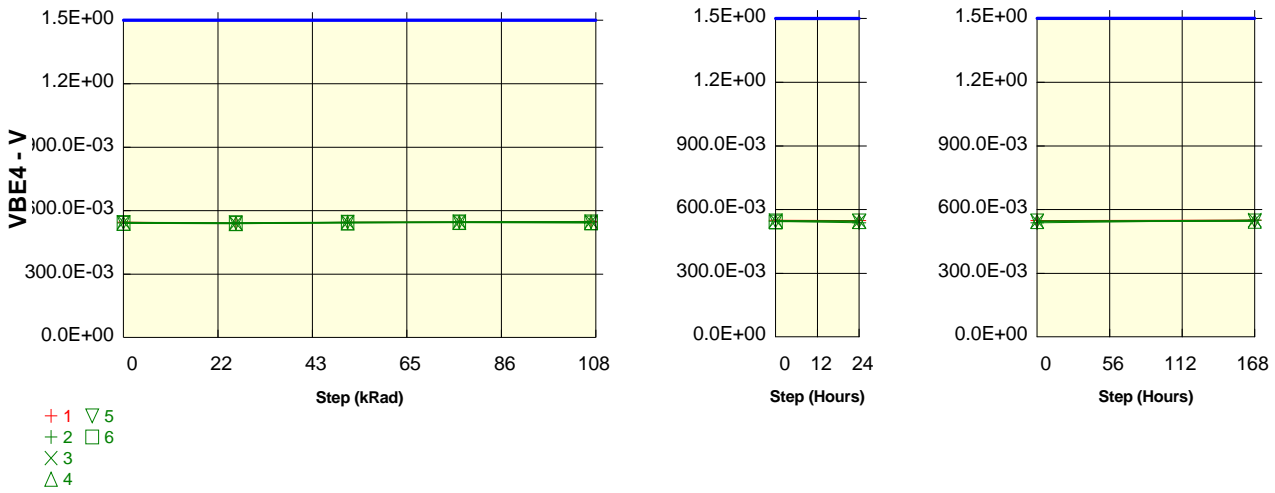

Measurements

VBE4	0 kRad	25.9 kRad	51.7 kRad	77.5 kRad	107.9 kRad	24 Hours	168 Hours
<b>1_REF</b>	545.6E-03	540.8E-03	544.4E-03	545.8E-03	549.6E-03	547.8E-03	551.2E-03
<b>ON samples</b>							
2	541.4E-03	539.8E-03	542.6E-03	544.0E-03	546.0E-03	538.4E-03	549.5E-03
3	544.8E-03	540.9E-03	546.2E-03	547.4E-03	548.0E-03	545.1E-03	550.8E-03
4	540.6E-03	538.4E-03	542.5E-03	544.2E-03	542.8E-03	543.2E-03	544.0E-03
5	544.2E-03	543.3E-03	545.7E-03	546.8E-03	546.6E-03	547.1E-03	546.7E-03
6	540.0E-03	538.8E-03	542.3E-03	543.2E-03	541.5E-03		
<b>Statistics</b>							
Min	540.0E-03	538.4E-03	542.3E-03	543.2E-03	541.5E-03	538.4E-03	544.0E-03
Max	544.8E-03	543.3E-03	546.2E-03	547.4E-03	548.0E-03	547.1E-03	550.8E-03
Average	542.2E-03	540.2E-03	543.9E-03	545.1E-03	545.0E-03	543.4E-03	547.7E-03
Sigma	1.9E-03	1.8E-03	1.7E-03	1.6E-03	2.5E-03	3.2E-03	2.6E-03
<b>(VBE) Lot WorstCase</b>	548.0E-03	545.6E-03	549.0E-03	550.0E-03	552.3E-03	553.1E-03	555.6E-03

Drift Calculation

VBE4	0 kRad	25.9 kRad	51.7 kRad	77.5 kRad	107.9 kRad	24 Hours	168 Hours
<b>ON samples</b>							
2	-	-1.60E-03	1.28E-03	2.68E-03	4.60E-03	-2.92E-03	8.16E-03
3	-	-3.88E-03	1.36E-03	2.56E-03	3.24E-03	280.02E-06	5.96E-03
4	-	-2.20E-03	1.92E-03	3.60E-03	2.16E-03	2.56E-03	3.44E-03
5	-	-840.01E-06	1.56E-03	2.60E-03	2.44E-03	2.96E-03	2.52E-03
6	-	-1.24E-03	2.32E-03	3.16E-03	1.48E-03		
Average	-	-1.95E-03	1.69E-03	2.92E-03	2.78E-03	719.99E-06	5.02E-03
Sigma	-	1.06E-03	385.67E-06	402.39E-06	1.07E-03	2.34E-03	2.21E-03
<b>d(VBE) Lot WorstCase</b>	-	1.24E-03	2.84E-03	4.13E-03	5.99E-03	7.73E-03	11.64E-03

**Test conditions : TID**  
**Parameter : Base-Emitter Voltage : VBE5**  
**Vce = 2V ; Ic = 10mA**  
 Unit : V  
 Spec Limit Max : 1.5E+00  
 Spec limits are represented in bold lines on the graphic.

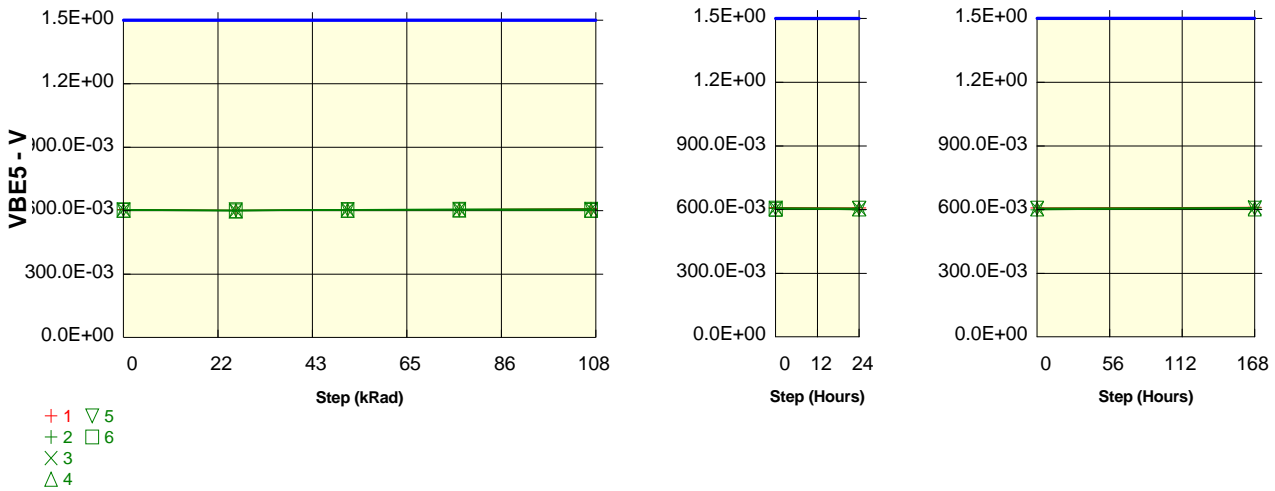

**Measurements**

VBE5	0 kRad	25.9 kRad	51.7 kRad	77.5 kRad	107.9 kRad	24 Hours	168 Hours
<b>1_REF</b>	605.5E-03	601.1E-03	604.4E-03	605.7E-03	609.1E-03	607.4E-03	610.5E-03
<b>ON samples</b>							
2	602.4E-03	599.7E-03	602.4E-03	603.6E-03	605.5E-03	598.6E-03	608.6E-03
3	604.8E-03	601.0E-03	605.8E-03	606.8E-03	607.6E-03	604.8E-03	610.0E-03
4	601.6E-03	598.5E-03	602.2E-03	603.8E-03	602.4E-03	602.8E-03	603.6E-03
5	604.2E-03	603.3E-03	605.4E-03	606.4E-03	606.2E-03	606.7E-03	606.3E-03
6	601.2E-03	598.7E-03	602.2E-03	602.8E-03	601.4E-03		
<b>Statistics</b>							
<b>Min</b>	601.2E-03	598.5E-03	602.2E-03	602.8E-03	601.4E-03	598.6E-03	603.6E-03
<b>Max</b>	604.8E-03	603.3E-03	605.8E-03	606.8E-03	607.6E-03	606.7E-03	610.0E-03
<b>Average</b>	602.8E-03	600.2E-03	603.6E-03	604.7E-03	604.6E-03	603.2E-03	607.1E-03
<b>Sigma</b>	1.4E-03	1.8E-03	1.6E-03	1.6E-03	2.3E-03	3.0E-03	2.4E-03
<b>(VBE) Lot WorstCase</b>	607.1E-03	605.5E-03	608.5E-03	609.5E-03	611.6E-03	612.3E-03	614.3E-03

**Drift Calculation**

VBE5	0 kRad	25.9 kRad	51.7 kRad	77.5 kRad	107.9 kRad	24 Hours	168 Hours
<b>ON samples</b>							
2	-	-2.72E-03	0.00E+00	1.20E-03	3.08E-03	-3.80E-03	6.16E-03
3	-	-3.84E-03	999.99E-06	2.04E-03	2.76E-03	0.00E+00	5.16E-03
4	-	-3.04E-03	639.98E-06	2.20E-03	880.00E-06	1.28E-03	2.04E-03
5	-	-920.00E-06	1.16E-03	2.16E-03	2.04E-03	2.52E-03	2.12E-03
6	-	-2.52E-03	959.99E-06	1.60E-03	120.04E-06		
<b>Average</b>	-	-2.61E-03	751.98E-06	1.84E-03	1.78E-03	-14.90E-09	3.87E-03
<b>Sigma</b>	-	956.46E-06	412.13E-06	384.50E-06	1.12E-03	2.37E-03	1.82E-03
<b>d(VBE) Lot WorstCase</b>	-	261.38E-06	1.99E-03	2.99E-03	5.14E-03	7.10E-03	9.34E-03

Test conditions : TID  
 Parameter : Base-Emitter Voltage : VBE6  
 Vce = 2V ; Ic = 100mA  
 Unit : V

Spec Limit Min : 630.0E-03  
 Spec Limit Max : 730.0E-03  
 Spec limits are represented in bold lines on the graphic.

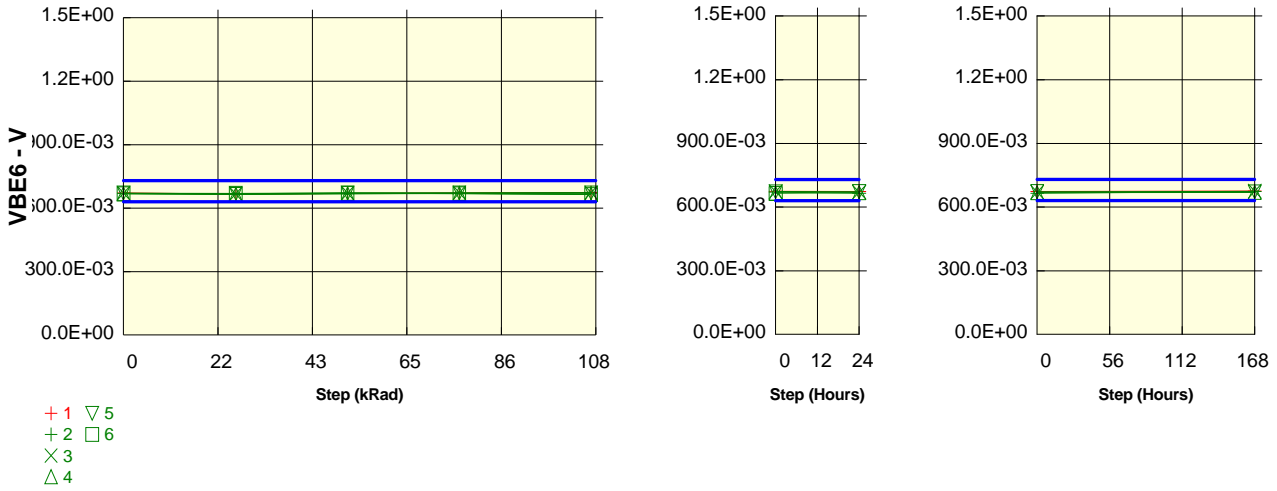

Measurements

VBE6	0 kRad	25.9 kRad	51.7 kRad	77.5 kRad	107.9 kRad	24 Hours	168 Hours
1_REF	672.0E-03	667.1E-03	668.7E-03	671.2E-03	674.3E-03	672.7E-03	675.6E-03
ON samples							
2	669.2E-03	666.3E-03	668.4E-03	669.2E-03	671.0E-03	664.8E-03	673.6E-03
3	671.1E-03	667.3E-03	671.2E-03	672.2E-03	672.8E-03	670.3E-03	675.0E-03
4	667.8E-03	665.4E-03	667.6E-03	668.9E-03	665.4E-03	668.1E-03	669.0E-03
5	670.9E-03	669.8E-03	671.2E-03	672.1E-03	672.0E-03	672.4E-03	672.1E-03
6	667.3E-03	665.2E-03	670.0E-03	667.9E-03	664.1E-03		
Statistics							
Min	667.3E-03	665.2E-03	667.6E-03	667.9E-03	664.1E-03	664.8E-03	669.0E-03
Max	671.1E-03	669.8E-03	671.2E-03	672.2E-03	672.8E-03	672.4E-03	675.0E-03
Average	669.2E-03	666.8E-03	669.7E-03	670.1E-03	669.1E-03	668.9E-03	672.4E-03
Sigma	1.6E-03	1.7E-03	1.4E-03	1.8E-03	3.6E-03	2.8E-03	2.3E-03
(VBE) Lot WorstCase	664.5E-03	661.7E-03	665.4E-03	664.8E-03	658.3E-03	660.4E-03	665.7E-03

Drift Calculation

VBE6	0 kRad	25.9 kRad	51.7 kRad	77.5 kRad	107.9 kRad	24 Hours	168 Hours
ON samples							
2	-	-2.84E-03	-720.02E-06	39.99E-06	1.84E-03	-4.40E-03	4.48E-03
3	-	-3.84E-03	79.99E-06	1.12E-03	1.68E-03	-840.01E-06	3.92E-03
4	-	-2.40E-03	-120.04E-06	1.16E-03	-2.32E-03	360.01E-06	1.20E-03
5	-	-1.12E-03	279.96E-06	1.16E-03	1.08E-03	1.44E-03	1.20E-03
6	-	-2.12E-03	2.68E-03	599.98E-06	-3.20E-03		
Average	-	-2.46E-03	439.98E-06	815.99E-06	-184.00E-06	-860.01E-06	2.70E-03
Sigma	-	890.32E-06	1.17E-03	442.25E-06	2.14E-03	2.20E-03	1.51E-03
d(VBE) Lot WorstCase	-	206.94E-06	3.95E-03	2.14E-03	6.23E-03	5.73E-03	7.24E-03

**Test conditions : TID**  
**Parameter : Base-Emitter Voltage : VBE7**  
**Vce = 2V ; Ic = 500mA**  
 Unit : V  
 Spec Limit Max : 1.5E+00  
 Spec limits are represented in bold lines on the graphic.

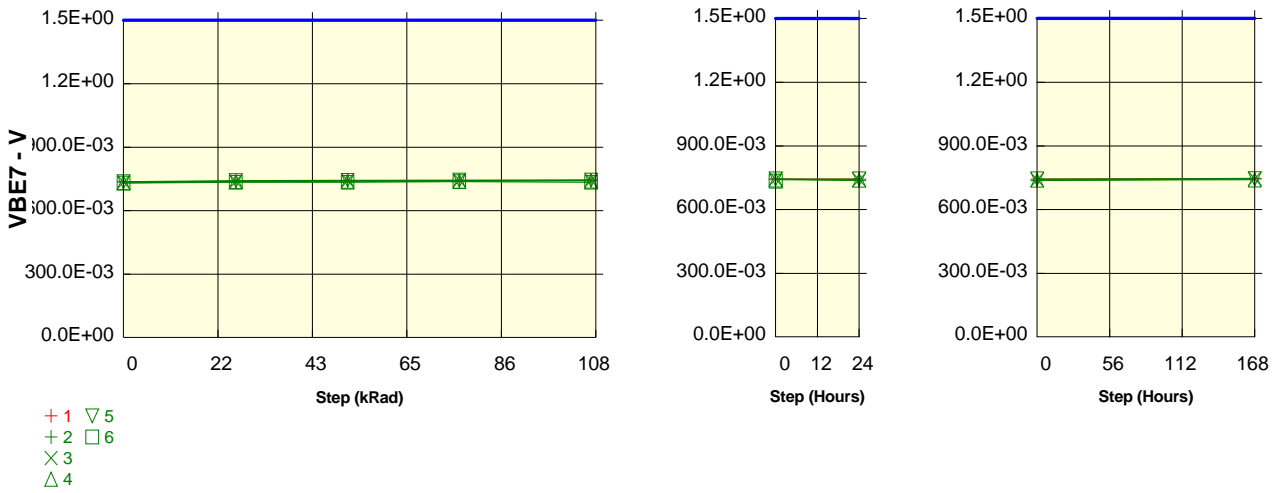

**Measurements**

VBE7	0 kRad	25.9 kRad	51.7 kRad	77.5 kRad	107.9 kRad	24 Hours	168 Hours
<b>1_REF</b>	736.9E-03	738.6E-03	741.4E-03	742.0E-03	744.9E-03	743.2E-03	747.7E-03
<b>ON samples</b>							
2	735.2E-03	738.1E-03	741.8E-03	740.4E-03	743.0E-03	737.2E-03	744.8E-03
3	735.5E-03	738.0E-03	742.2E-03	743.0E-03	743.5E-03	740.7E-03	745.7E-03
4	731.7E-03	736.6E-03	738.6E-03	738.4E-03	740.4E-03	738.0E-03	740.2E-03
5	736.4E-03	741.8E-03	743.0E-03	743.8E-03	743.9E-03	744.2E-03	745.3E-03
6	730.3E-03	734.0E-03	734.5E-03	736.8E-03	734.4E-03		
<b>Statistics</b>							
Min	730.3E-03	734.0E-03	734.5E-03	736.8E-03	734.4E-03	737.2E-03	740.2E-03
Max	736.4E-03	741.8E-03	743.0E-03	743.8E-03	743.9E-03	744.2E-03	745.7E-03
Average	733.8E-03	737.7E-03	740.0E-03	740.5E-03	741.0E-03	740.0E-03	744.0E-03
Sigma	2.4E-03	2.5E-03	3.1E-03	2.7E-03	3.6E-03	2.7E-03	2.2E-03
<b>(VBE) Lot WorstCase</b>	740.9E-03	745.3E-03	749.4E-03	748.4E-03	751.7E-03	748.2E-03	750.7E-03

**Drift Calculation**

VBE7	0 kRad	25.9 kRad	51.7 kRad	77.5 kRad	107.9 kRad	24 Hours	168 Hours
<b>ON samples</b>							
2	-	2.92E-03	6.56E-03	5.20E-03	7.80E-03	2.04E-03	9.60E-03
3	-	2.48E-03	6.72E-03	7.52E-03	8.00E-03	5.20E-03	10.24E-03
4	-	4.84E-03	6.84E-03	6.72E-03	8.64E-03	6.32E-03	8.44E-03
5	-	5.40E-03	6.60E-03	7.36E-03	7.52E-03	7.80E-03	8.92E-03
6	-	3.68E-03	4.24E-03	6.48E-03	4.08E-03		
Average	-	3.86E-03	6.19E-03	6.66E-03	7.21E-03	5.34E-03	9.30E-03
Sigma	-	1.11E-03	980.89E-06	824.25E-06	1.61E-03	2.12E-03	681.48E-06
<b>d(VBE) Lot WorstCase</b>	-	7.19E-03	9.13E-03	9.13E-03	12.03E-03	11.69E-03	11.34E-03



**Test conditions : TID**  
**Parameter : Base-Emitter Voltage : VBE8**  
**Vce = 2V ; Ic = 1A**  
 Unit : V  
 Spec Limit Max : 1.5E+00  
 Spec limits are represented in bold lines on the graphic.

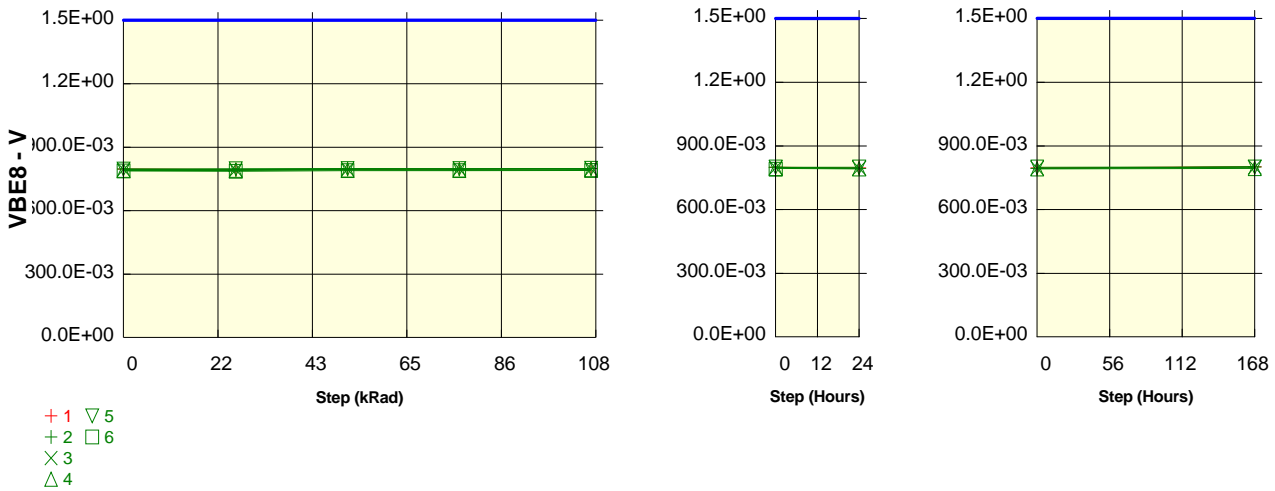

**Measurements**

VBE8	0 kRad	25.9 kRad	51.7 kRad	77.5 kRad	107.9 kRad	24 Hours	168 Hours
<b>1_REF</b>	796.5E-03	793.5E-03	795.3E-03	796.4E-03	799.1E-03	797.2E-03	801.2E-03
<b>ON samples</b>							
2	796.4E-03	793.0E-03	799.2E-03	795.4E-03	799.1E-03	793.4E-03	800.1E-03
3	794.3E-03	792.4E-03	795.4E-03	797.2E-03	797.5E-03	794.4E-03	800.1E-03
4	790.0E-03	790.8E-03	792.3E-03	791.4E-03	793.6E-03	791.2E-03	793.4E-03
5	796.7E-03	798.1E-03	798.8E-03	799.4E-03	799.8E-03	799.8E-03	800.6E-03
6	787.3E-03	786.4E-03	788.8E-03	788.8E-03	789.8E-03		
<b>Statistics</b>							
<b>Min</b>	787.3E-03	786.4E-03	788.8E-03	788.8E-03	789.8E-03	791.2E-03	793.4E-03
<b>Max</b>	796.7E-03	798.1E-03	799.2E-03	799.4E-03	799.8E-03	799.8E-03	800.6E-03
<b>Average</b>	792.9E-03	792.1E-03	794.9E-03	794.4E-03	796.0E-03	794.7E-03	798.5E-03
<b>Sigma</b>	3.7E-03	3.8E-03	3.9E-03	3.9E-03	3.7E-03	3.2E-03	3.0E-03
<b>(VBE) Lot WorstCase</b>	804.0E-03	803.5E-03	806.7E-03	806.1E-03	807.2E-03	804.3E-03	807.4E-03

**Drift Calculation**

VBE8	0 kRad	25.9 kRad	51.7 kRad	77.5 kRad	107.9 kRad	24 Hours	168 Hours
<b>ON samples</b>							
2	-	-3.40E-03	2.80E-03	-999.98E-06	2.72E-03	-2.92E-03	3.72E-03
3	-	-1.84E-03	1.08E-03	2.96E-03	3.20E-03	159.99E-06	5.84E-03
4	-	759.97E-06	2.28E-03	1.36E-03	3.60E-03	1.16E-03	3.44E-03
5	-	1.44E-03	2.12E-03	2.76E-03	3.12E-03	3.16E-03	3.88E-03
6	-	-919.99E-06	1.52E-03	1.48E-03	2.56E-03		
<b>Average</b>	-	-792.01E-06	1.96E-03	1.51E-03	3.04E-03	389.97E-06	4.22E-03
<b>Sigma</b>	-	1.75E-03	600.25E-06	1.41E-03	368.36E-06	2.20E-03	948.49E-06
<b>d(VBE) Lot WorstCase</b>	-	4.46E-03	3.76E-03	5.75E-03	4.15E-03	6.98E-03	7.07E-03

**Test conditions : TID**  
**Parameter : Base-Emitter Voltage : VBE9**  
**Vce = 2V ; Ic = 2A**  
 Unit : V  
 Spec Limit Max : 1.5E+00  
 Spec limits are represented in bold lines on the graphic.

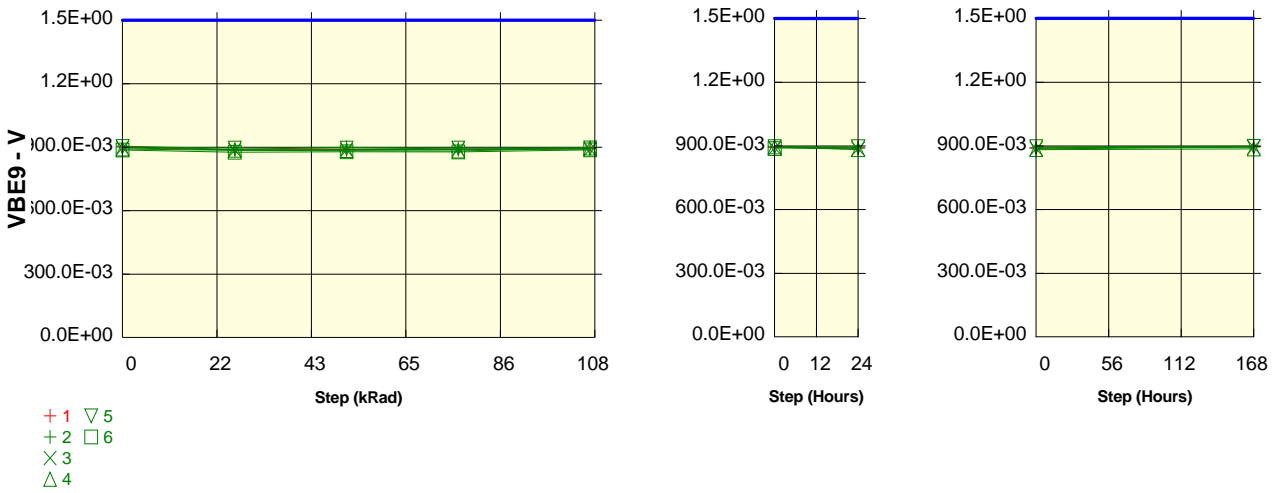

**Measurements**

VBE9	0 kRad	25.9 kRad	51.7 kRad	77.5 kRad	107.9 kRad	24 Hours	168 Hours
<b>1_REF</b>	900.8E-03	887.8E-03	888.4E-03	889.6E-03	892.3E-03	889.9E-03	895.0E-03
<b>ON samples</b>							
<b>2</b>	904.2E-03	889.6E-03	899.0E-03	890.4E-03	896.3E-03	890.5E-03	895.7E-03
<b>3</b>	897.4E-03	885.9E-03	887.7E-03	890.8E-03	890.8E-03	886.5E-03	893.7E-03
<b>4</b>	891.4E-03	885.2E-03	884.1E-03	881.9E-03	895.9E-03	882.2E-03	886.0E-03
<b>5</b>	902.5E-03	895.4E-03	894.9E-03	895.7E-03	896.6E-03	896.0E-03	897.6E-03
<b>6</b>	886.4E-03	876.0E-03	878.5E-03	877.2E-03	887.8E-03		
<b>Statistics</b>							
<b>Min</b>	886.4E-03	876.0E-03	878.5E-03	877.2E-03	887.8E-03	882.2E-03	886.0E-03
<b>Max</b>	904.2E-03	895.4E-03	899.0E-03	895.7E-03	896.6E-03	896.0E-03	897.6E-03
<b>Average</b>	896.4E-03	886.4E-03	888.8E-03	887.2E-03	893.5E-03	888.8E-03	893.3E-03
<b>Sigma</b>	6.7E-03	6.3E-03	7.4E-03	6.7E-03	3.6E-03	5.1E-03	4.4E-03
<b>(VBE) Lot WorstCase</b>	916.4E-03	905.4E-03	910.9E-03	907.2E-03	904.2E-03	904.1E-03	906.5E-03

**Drift Calculation**

VBE9	0 kRad	25.9 kRad	51.7 kRad	77.5 kRad	107.9 kRad	24 Hours	168 Hours
<b>ON samples</b>							
<b>2</b>	-	-14.52E-03	-5.20E-03	-13.72E-03	-7.84E-03	-13.68E-03	-8.48E-03
<b>3</b>	-	-11.52E-03	-9.72E-03	-6.60E-03	-6.56E-03	-10.88E-03	-3.68E-03
<b>4</b>	-	-6.28E-03	-7.36E-03	-9.52E-03	4.44E-03	-9.20E-03	-5.44E-03
<b>5</b>	-	-7.12E-03	-7.56E-03	-6.80E-03	-5.84E-03	-6.44E-03	-4.84E-03
<b>6</b>	-	-10.36E-03	-7.92E-03	-9.16E-03	1.36E-03		
<b>Average</b>	-	-9.96E-03	-7.55E-03	-9.16E-03	-2.89E-03	-10.05E-03	-5.61E-03
<b>Sigma</b>	-	3.00E-03	1.44E-03	2.57E-03	4.87E-03	2.63E-03	1.77E-03
<b>d(VBE) Lot WorstCase</b>	-	-960.45E-06	-3.22E-03	-1.45E-03	11.71E-03	-2.17E-03	-289.05E-06