



Single Event Transient Test Report

TL431BMFDT,215

Date Code: 1908

Programmable Shunt Regulator with 2.5V Bandgap Voltage Reference

Nexperia

Prepared by	Florian Kimmel
Reference	ESA-TECQEC-TR-2022-000880
Issue/Revision	0.0
Date of Issue	03/01/2022
Status	published/authorized



APPROVAL

Title Single Event Transient Test Report TL431BMFDT,215	
Issue Number 0	Revision Number 0
Author Florian Krimmel	Date 03/01/2021
Approved By	Date of Approval

CHANGE LOG

Reason for change	Issue Nr.	Revision Number	Date

CHANGE RECORD

Issue Number 0	Revision Number 0		
Reason for change	Date	Pages	Paragraph(s)

DISTRIBUTION

Name/Organisational Unit



Table of contents:

1 APPLICABLE/REFERENCE DOCUMENTS 4

2 TEST OBJECTIVES AND REQUIREMENTS TO BE VERIFIED 4

2.1 Test Objectives.....4

2.2 Test facility.....4

3 DUT & TEST CONFIGURATION/CONDITIONS5

3.1 Description of the DUT.....5

3.2 DUT Preparation6

3.3 Test set-up description and preparation.....6

3.4 Test Parameters..... 8

4 TEST RESULTS 9

4.1 Run Log9

4.2 Cross Section10

4.3 Transients..... 11

4.4 Transients Compared 12

4.5 Pulse width and amplitude..... 15

4.6 Pulse width compared..... 19

5 CONCLUSION 19

1 APPLICABLE/REFERENCE DOCUMENTS

1. ESCC25100 section 6: Single Event Effects Test Methods and Guidelines
2. Datasheet of TL431BMFDT,215:
https://assets.nexperia.com/documents/data-sheet/TL431_FAM.pdf

2 TEST OBJECTIVES AND REQUIREMENTS TO BE VERIFIED

2.1 Test Objectives

Test objective is to assess the heavy-ion SET sensitivity of this part.

This test report will be uploaded in the ESA Radiation Database (<https://esarad.esa.int>) and this data should also contribute to the development of safe design margins for COTS components.

The test campaign was performed on the 10th November at UCL.

2.2 Test facility

UCL Louvain Heavy Ion Facility

<https://uclouvain.be/en/research-institutes/irmp/crc/heavy-ion-facility-hif.html>

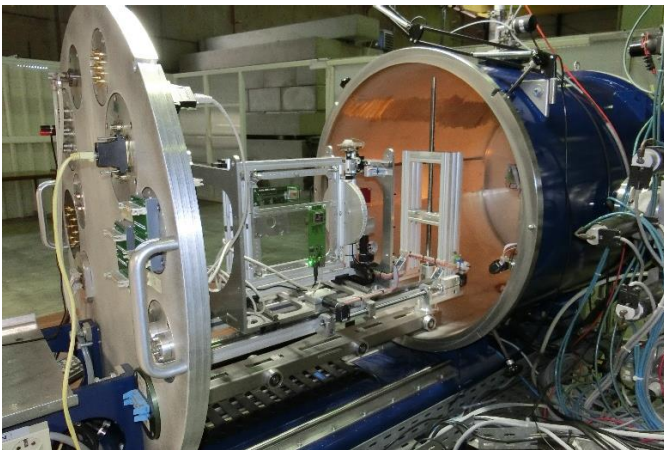

-Irradiation area: $\varnothing 25$ mm

-Flux from a few ions/(s.cm²) up to 1,5E4 ions/(s.cm²)



Ion	Energy on device [MeV]	Range on device [μm]	LET on device [MeV/(mg/cm ²)]
¹³ C ⁴⁺	131	269,3	1,3
²² Ne ⁷⁺	238	202	3,3
²⁷ Al ⁸⁺	250	131,2	5,7
³⁶ Ar ¹¹⁺	353	114,0	9,9
⁵³ Cr ¹⁶⁺	505	105,5	16,1
⁵⁸ Ni ¹⁸⁺	582	100,5	20,4
⁸⁴ Kr ²⁵⁺	769	94,2	32,4
¹⁰³ Rh ³¹⁺	957	87,3	46,1
¹²⁴ Xe ³⁵⁺	995	73,1	62,5

The ions used are highlighted.
 Fluence was adapted in order to have enough statistical events.
 All test were performed without tilting the components.

3 DUT & TEST CONFIGURATION/CONDITIONS

3.1 Description of the DUT

The TL431 is a three-terminal shunt regulator family with an output voltage range between $V_{ref} = 2.495\text{ V}$ and 36 V , to be set by two external resistors.

For the test, two samples of the same type have been used.
 The table below shows the key parameters of the selected DUTs.

Component Family Name	Component Name	Manufacturer	Automotive, AEC-Q100	Distributor	Component Laser Marking	Date-code YYWW	Lot-code from distributor
TL431	TL431BMFDT,215	Nexperia	yes	Farnell	AWW 98	1908	-

Vz	Initial Tolerance	IZ_min	IZ_typ	IZ_max	Long term stab.	Hysteresis (thermal) -40 to 125 degC	Package
2.495 V	0.5 %	1mA	10mA	100mA	-	-	SOT-23-3

3.2 DUT Preparation

Two sets of the samples have been decapsulated by using Nitric Acid on the top side as shown in the pictures below:

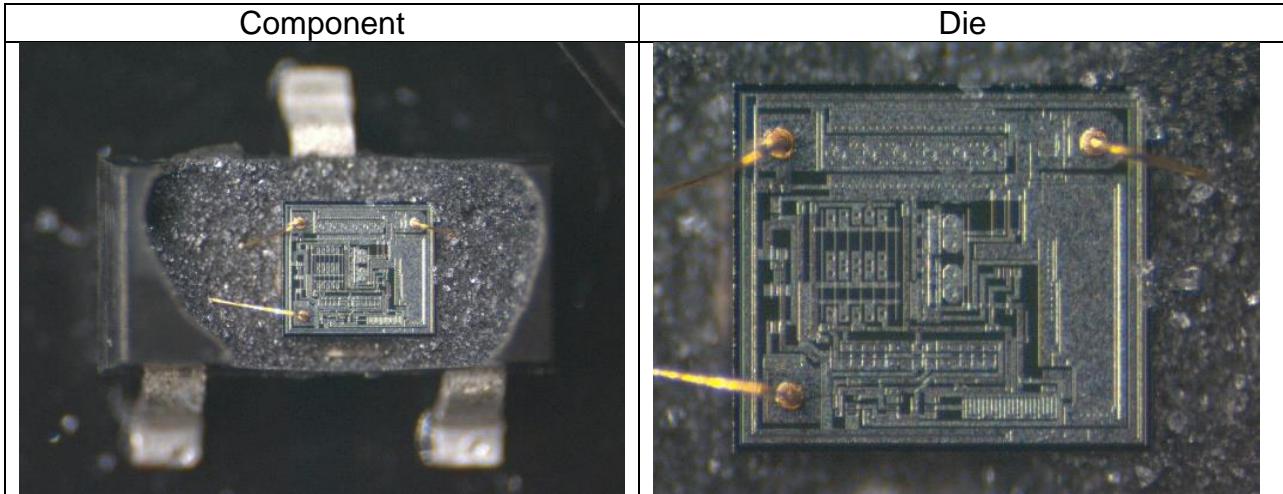

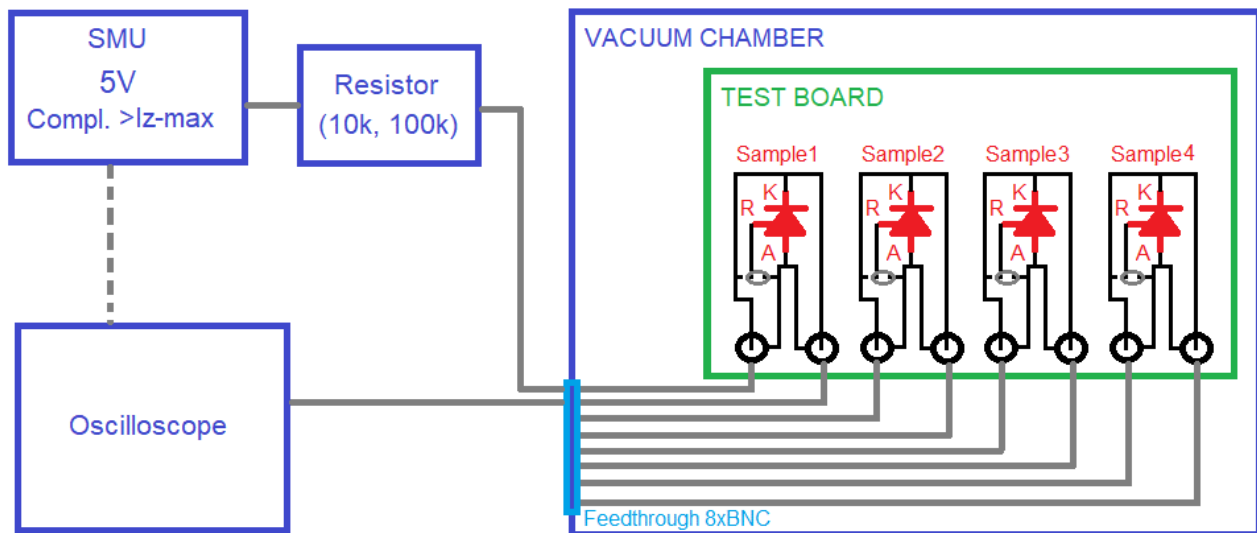

3.3 Test set-up description and preparation

Schematic:



Measurement equipment:

<p>Oscilloscope Agilent Technologies infiniium MSO9404A: 4Ghz</p>	
<p>SMU source measure unit KEITHLEY 2410</p>	

Test Board mounted on the frame inside the vacuum chamber:

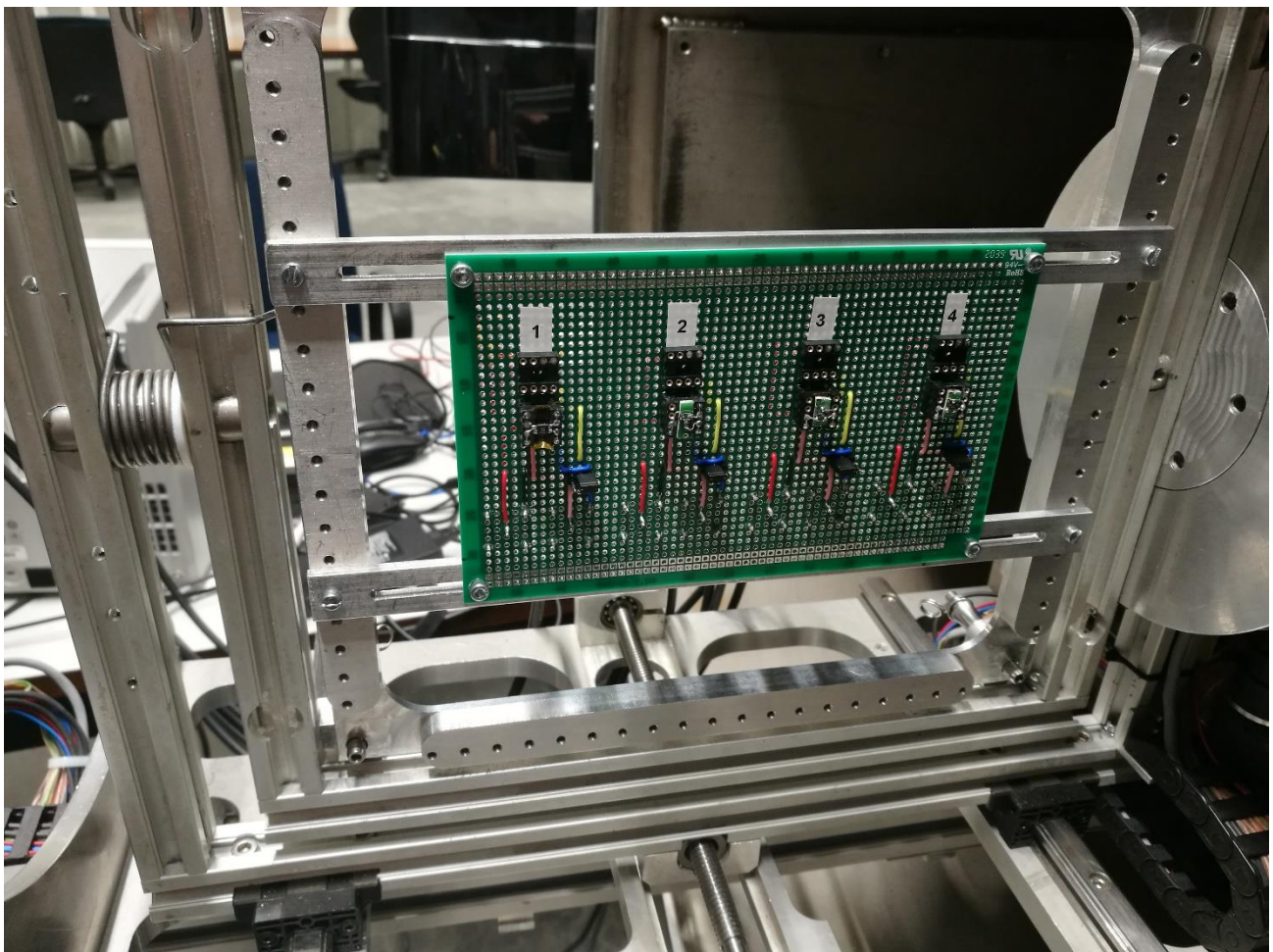

3.4 Test Parameters

Voltage Source:

- Provides a constant voltage of 5V
- Resistor adjusted accordingly to reach the min, typ and max I_z current (Value according to run log table)
- No capacitor on the input of the component

Load:

- Output of the references unloaded and without capacitor

Environmental condition:

- All test performed under vacuum
- All test performed at room temperature

Oscilloscope:

- Trigger Mode: Window trigger (min and max)
- Trigger level: as small as possible depending on the background noise (+- 150mV)

Connection of the reference pin:

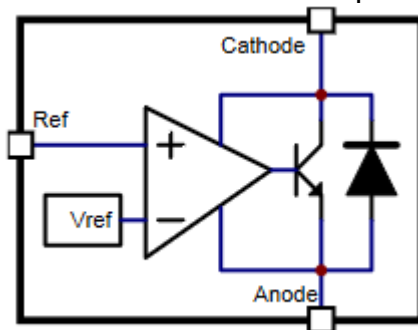

The reference pin can be connected via a jumper on the test board to the Anode or the Cathode.



4 TEST RESULTS

4.1 Run Log

The Log table below shows all successful runs related to the component TL431BMFDT,215:

PRE-RUN INPUTS																			
Run	DUT	Input Voltage (V)	Input resistor (Ohm)	Iz (MIN, TYP, MAX)	Ref pin configuration (A, anode or K)	Title (*)	Vacuum (Y/N)?	Particle	Energy (MeV)	LET Normal in SI (90°) [For P see "SRIM"]	LET Effective (in SI)	Range (um)	Flux target (/cm²/s)	Fluence target (/cm²)	Duration Target (sec)	Beam Homogeneity (%)	Scope - Trig. High (V)	Scope - Trig. Low (V)	Scope - Hold off time (us)
8	TL431_Nex_S1	5	27	MAX	K	0	Yes	Xe	995	62.5	62.5	73.1	2.00E+02	1.00E+09	5000000	10	2.65	2.35	20
9	TL431_Nex_S1	5	240	TYP	K	0	Yes	Xe	995	62.5	62.5	73.1	2.00E+02	1.00E+09	5000000	10	2.65	2.35	20
10	TL431_Nex_S1	5	2400	MIN	K	0	Yes	Xe	995	62.5	62.5	73.1	2.00E+02	1.00E+09	5000000	10	2.65	2.35	20
11	TL431_Nex_S1	5	2400	MIN	K	0	Yes	Xe	995	62.5	62.5	73.1	2.00E+02	1.00E+09	5000000	10	2.65	2.35	10
12	TL431_Nex_S1	25.3	2200	TYP	K	0	Yes	Xe	995	62.5	62.5	73.1	2.00E+02	1.00E+09	5000000	10	2.65	2.35	10
24	TL431_Nex_S1	5	240	TYP	K	0	Yes	Kr	769	32.4	32.4	94.2	1.00E+03	1.00E+09	1000000	10	2.65	2.35	20
27	TL431_Nex_S1	5	240	TYP	K	0	Yes	Cr	505	16.1	16.1	105.5	2.50E+03	1.00E+09	400000	10	2.65	2.35	20
31	TL431_Nex_S2	5	240	TYP	K	0	Yes	Cr	505	16.1	16.1	105.5	5.00E+03	1.00E+09	200000	10	2.65	2.35	20

POST-RUN INPUTS & RESULTS															Observations	
Run	DUT	Start time	Duration actual (sec)	Fluence actual (/cm²)	Cumulative Fluence (/cm²)	Flux actual (/cm²/s)	Run dose (krad)	Total dose (krad)	Test OK/ NOK	Vout average (V)	Iz measured (mA)	# SET (scope triggers)	SET XS (cm²)	Vmax for this run (V)		Vmin for this run (V)
8	TL431_Nex_S1	18:14	464	9.91E+04	9.91E+04	213.577586	9.91E-02	9.91E-02	OK	2.48	90.99	306	3.09E-03	6.959	0.544	No SET beyond scope voltage amplitude measured. Some rare very small SET (see above).
9	TL431_Nex_S1	18:26	666	1.46E+05	2.45E+05	219.219219	1.46E-01	2.45E-01	OK	2.46	10.41	303	2.08E-03	4.382	0.219	Settings seemed OK. Good run.
10	TL431_Nex_S1	18:41	626	1.37E+05	3.82E+05	218.84984	1.37E-01	3.82E-01	OK - b	2.45	1.044	345	2.52E-03	2.959	<0	Very rare small SET, but also very few SET going below DV
11	TL431_Nex_S1	18:57	425	9.58E+04	4.78E+05	225.411765	9.58E-02	4.78E-01	OK - b	2.43	1.044	328	3.42E-03	2.965	-0.016	Rare SET below DV (inductance?), still some SET were triggered before the temporal trigger (might be due to the way the trigger rule is defined?), otherwise OK.
12	TL431_Nex_S1	19:12	426	9.33E+04	5.71E+05	219.014085	9.33E-02	5.71E-01	OK	2.45	10.42	311	3.33E-03	4.687	0.058	Objective was to see the effect of Vin for the same condition of TYP. Seems similar to run 9
24	TL431_Nex_S1	21:43	131	1.28E+05	1.28E+05	977.099237	6.64E-02	6.38E-01	OK	2.47	10.41	265	2.07E-03	4.204	0.901	Settings are ok, run good.
27	TL431_Nex_S1	22:19	79	1.85E+05	1.85E+05	2341.77215	4.77E-02	6.85E-01	OK	2.48	10.41	238	1.29E-03	3.9506	1.383	Flux also increased to speed up, but flux seems OK but on the high end.
31	TL431_Nex_S2	22:54	56	3.01E+05	3.01E+05	5375	7.75E-02	7.75E-02	OK	2.48	10.42	356	1.18E-03	4.064	1.347	Testing Sample 2 of this component for statistics.

The component has been tested with three different ions (Xe, Kr, Cr). Under Xe, three tests runs at different Iz currents have been done in order to spot the worst case conditions.

Only the typical Iz values was used to test under Kr and Cr.

The last run was done with nominal Iz condition but on a second to verify any possible part-to-part variations.

Run 12 repeat the same condition than Run 9 but with higher input voltage and higher input resistance to see how much the parasitic inductance and capacitance influence the result even if the Iz current is the same.

The two samples received a total cumulative TID of 0.68 krad and 0.07 krad.

4.2 Cross Section

The cross section of all runs was calculated and is shown in the plot for different LETs.

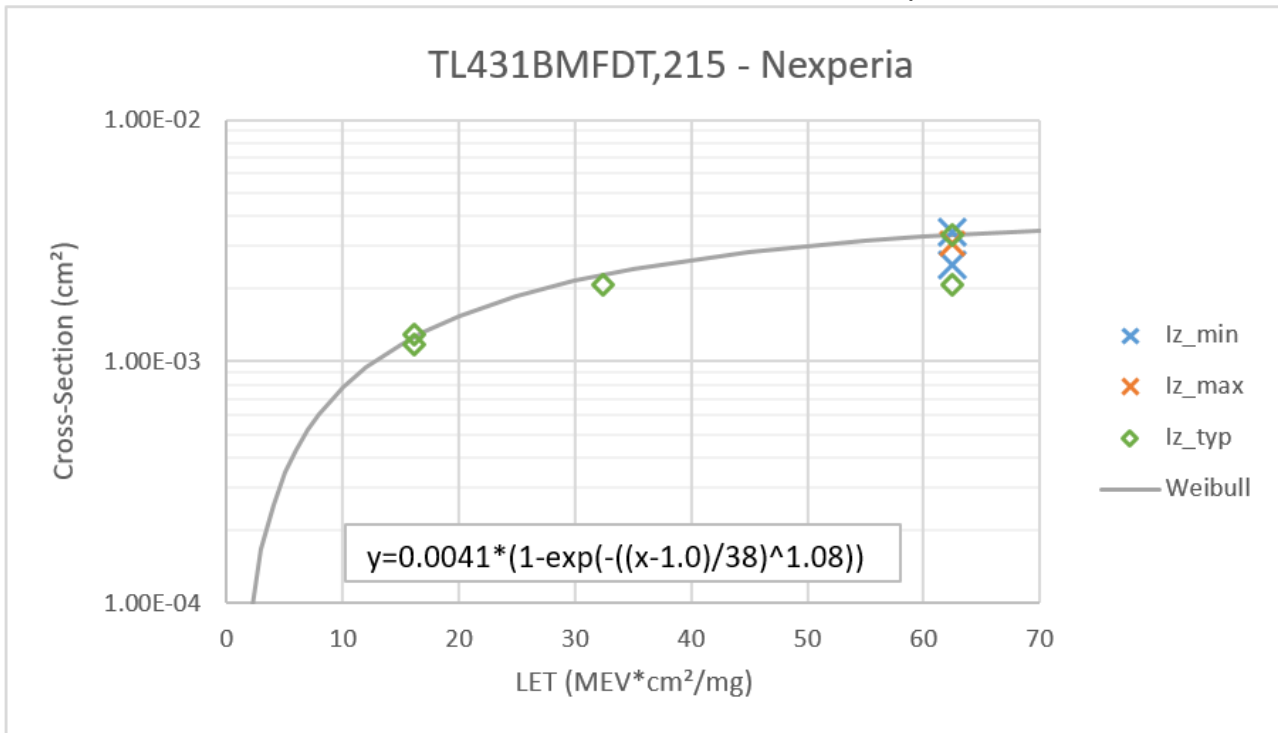

Weibull parameters	
W	38
S	1.08
Limit	0.0041
LET threshold	1.0

All different tested Iz condition show a similar behaviour in the same order of magnitude.

The part to part variation at a LET of 16.1 MeV*cm²/mg appears very low.

At the LET of 62.5 it can be seen that the cross-section increased from 2E-3 to 3E-3 cm² by changing the anode-cathode voltage from 5V to 25.3V.

Due to the fact that around 300 events were measured, the very small error bars were not displayed.

The LET threshold is estimated only with 3 points interpolation with high inaccuracy. For a more accurate Weibull curve, more measurement points are required, including some close to the LET threshold.

4.3 Transients

The following table shows examples of worst case transients observed on the DUT.

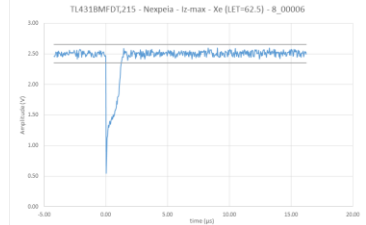
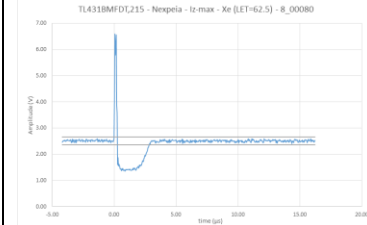
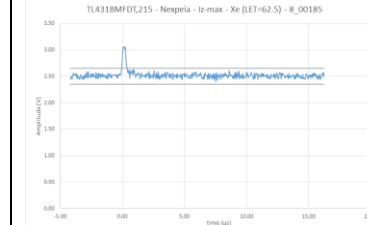
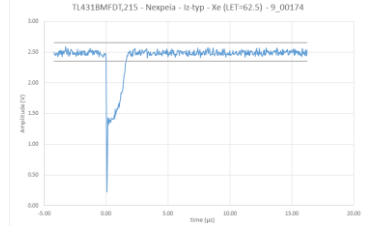
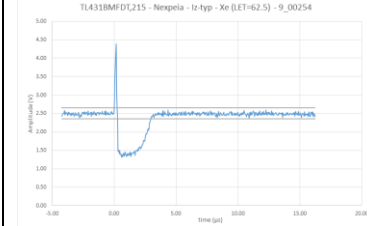
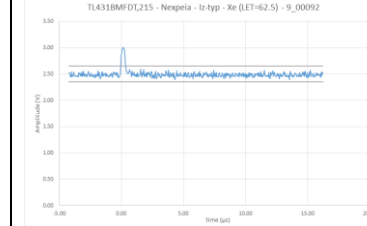
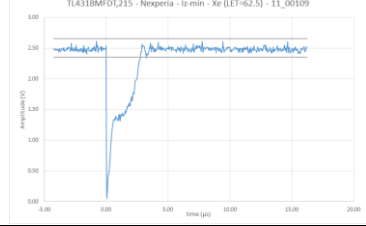
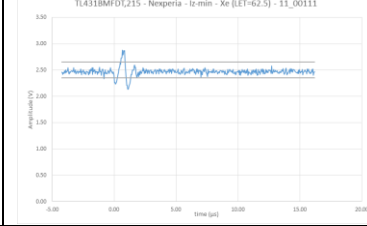
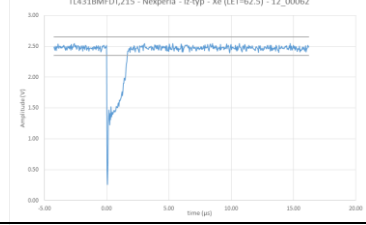
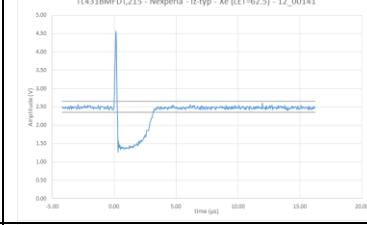
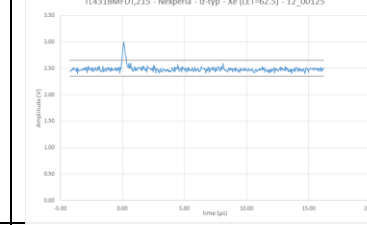
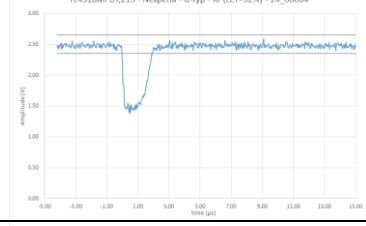
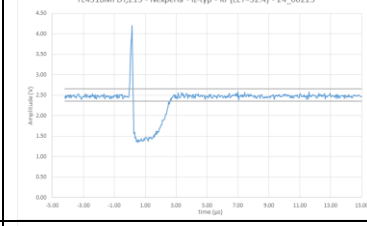
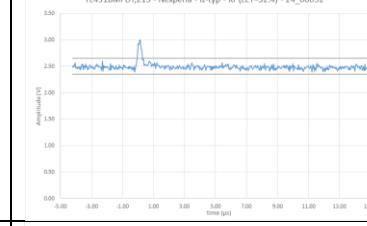
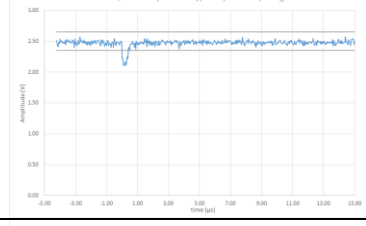
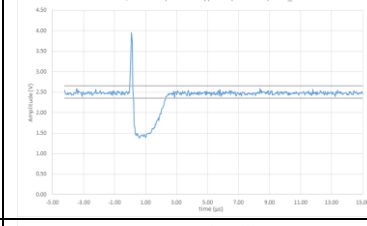
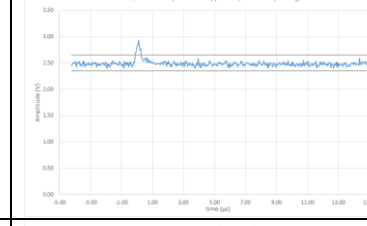
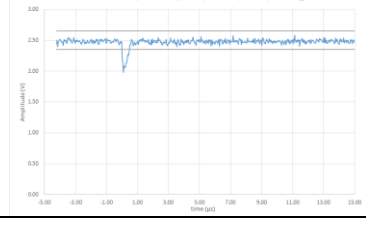
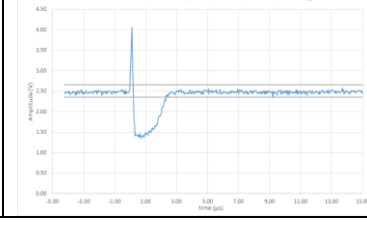
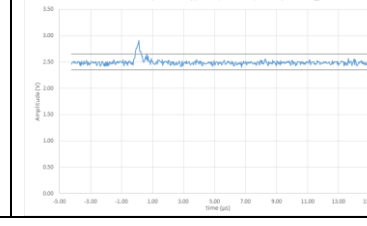
Run No.	only negative pulses	bipolar pulses	only positive pulses
8 Iz-max LET=62.5			
9 Iz-typ LET=62.5			
11 Iz-min LET=62.5			
12 Iz-typ LET=62.5 25V			
24 Iz-typ LET=32.4			
27 Iz-typ LET=16.1			
31 Iz-typ LET=16.1 Sample2			

4.4 Transients Compared

The following plots show the different shape of the worst-case transients for negative, positive and bipolar pulses regarding the LET and different Iz values.

Negative pulses are those that have only exceeded the lower trigger level and the same for the positive pulses with the higher trigger level. Bipolar pulses are those events, which exceeded both the higher and the lower trigger level.

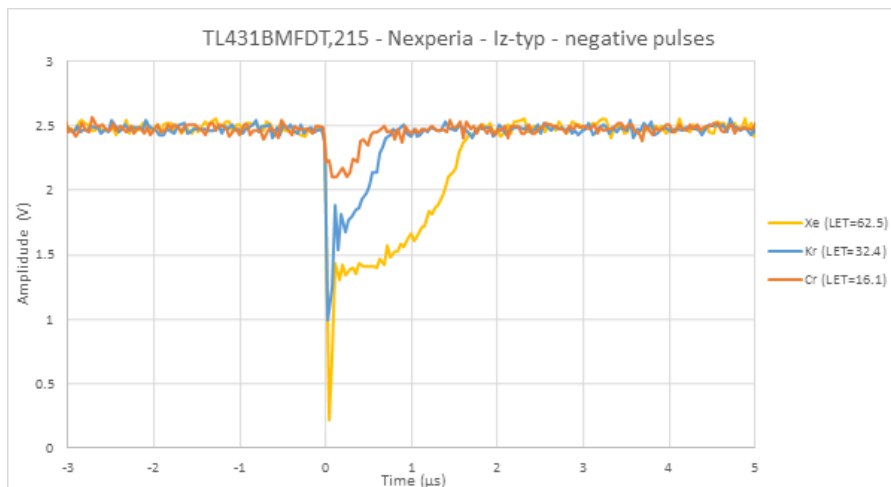
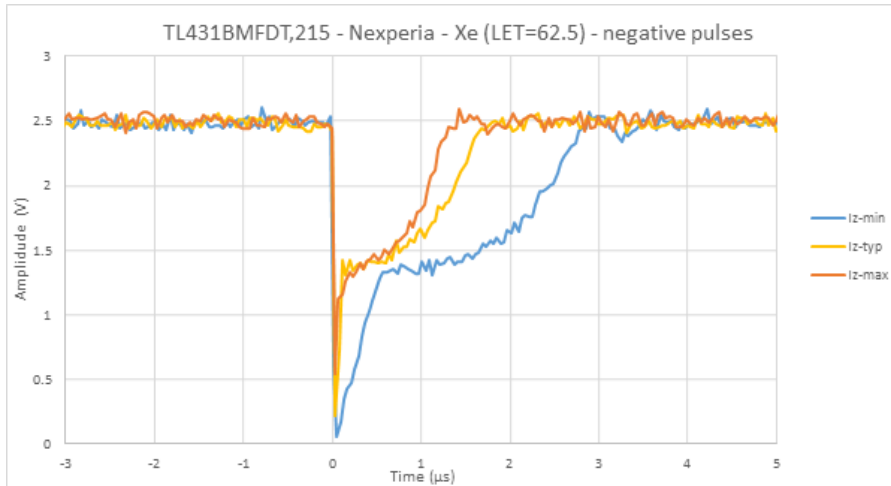

The worst-case negative transients seem to be dependent of the LET as well of the Iz condition in terms of their pulse width and there amplitude.

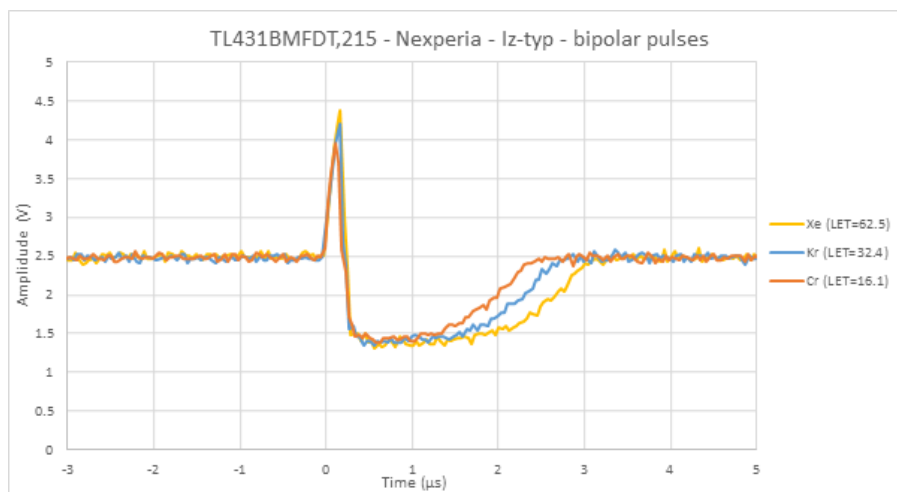
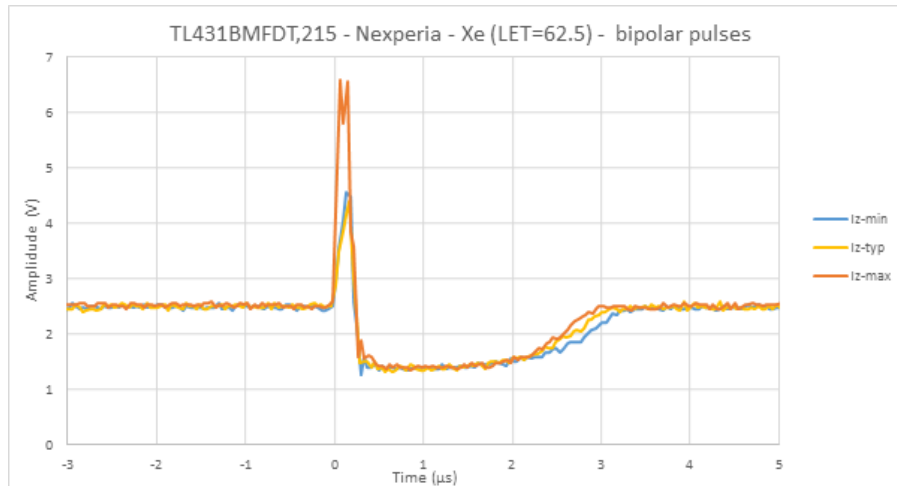

The worst-case bipolar transients seem to be less dependent of the LET as well of the Iz condition in terms of their pulse width and their amplitude.

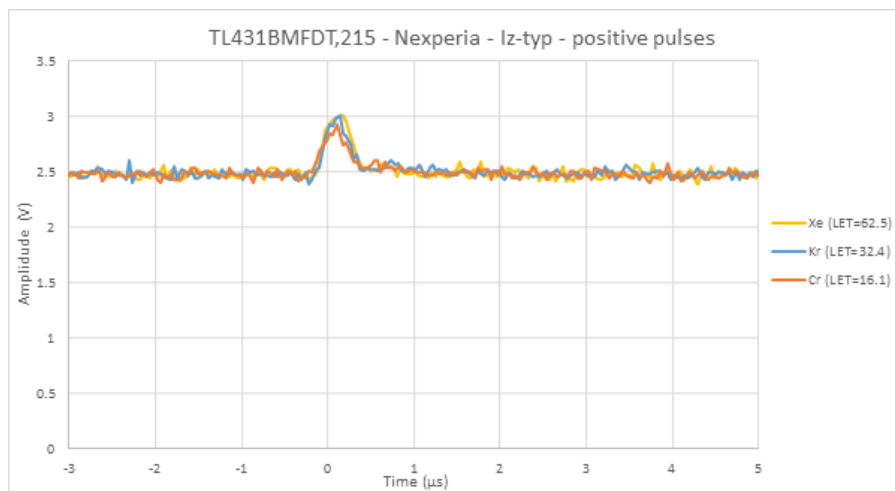
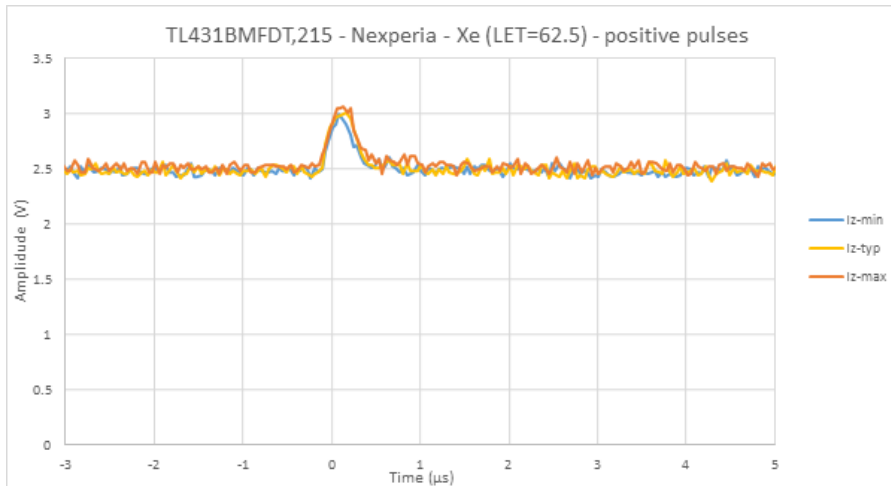

The worst-case positive transients seem to be almost not dependent of the LET and Iz condition in terms of their pulse width and there amplitude.

4.5 Pulse width and amplitude

The following plots show all transients for each run on a plot regarding their maximum amplitude and the pulse width. The colour of the groups indicates if the pulse was only negative, positive or bipolar.

The pulses in grey are events, which triggered the scope but do not show any measurement pion outside the trigger levels due to the limited sampling rate.

The Amplitude level is plotted relative to the average output voltage without events.

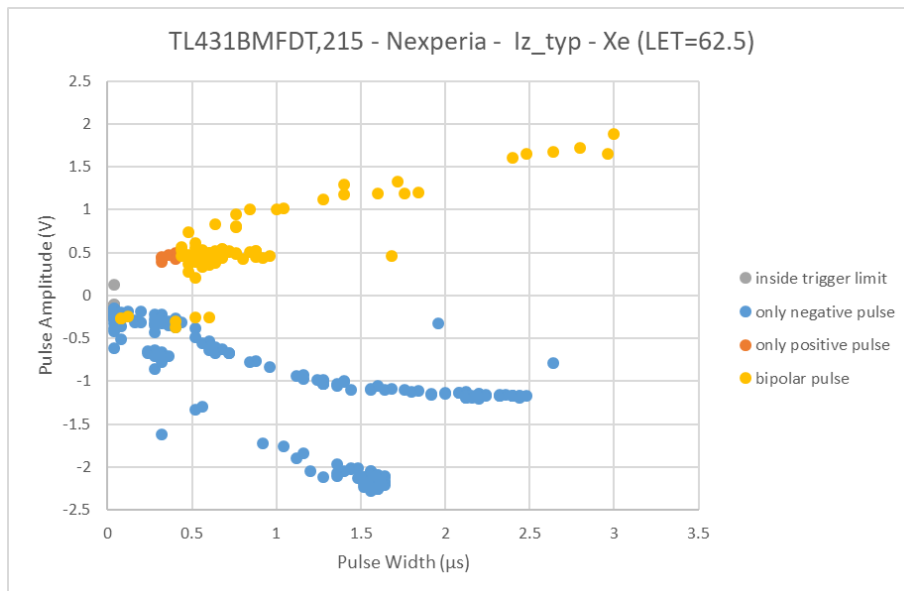
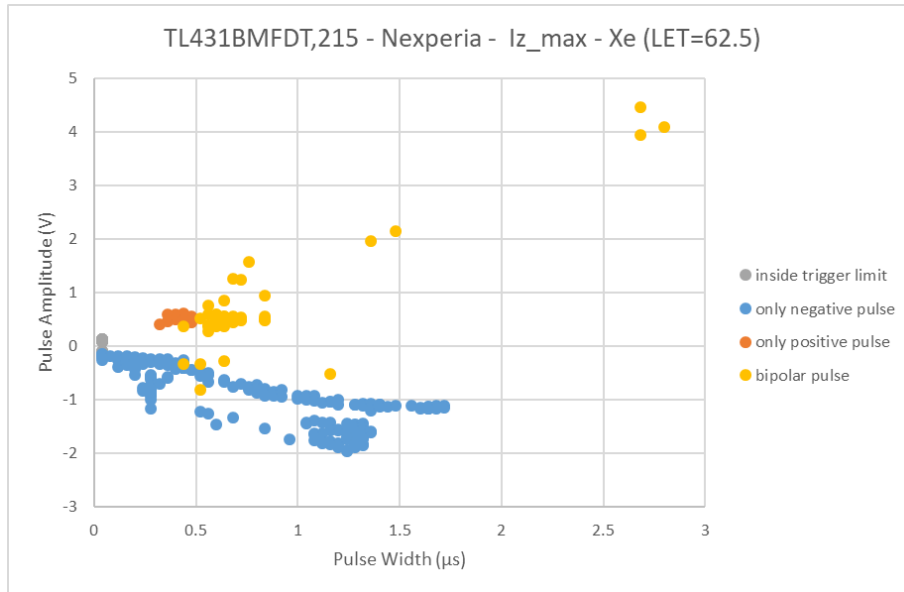

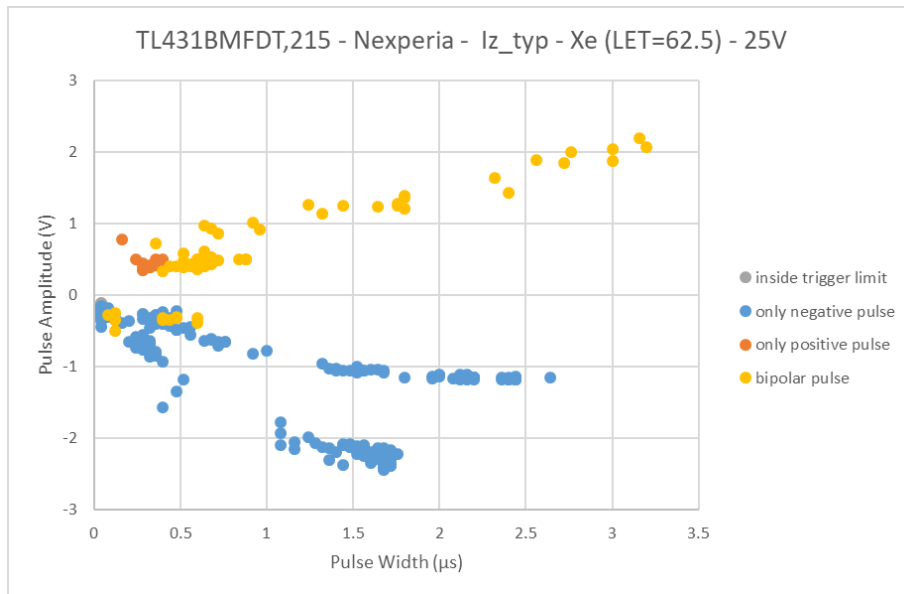
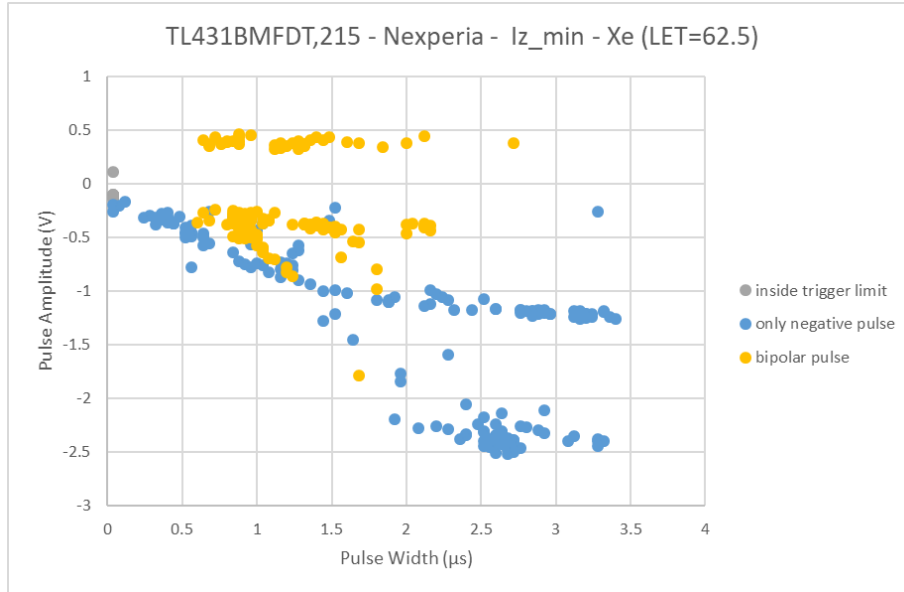

The 25V measurement results compared to the 5V look very similar regarding the pulse amplitude and the pulse width but the cross section being 50% larger for 25V than with 5V input voltage.

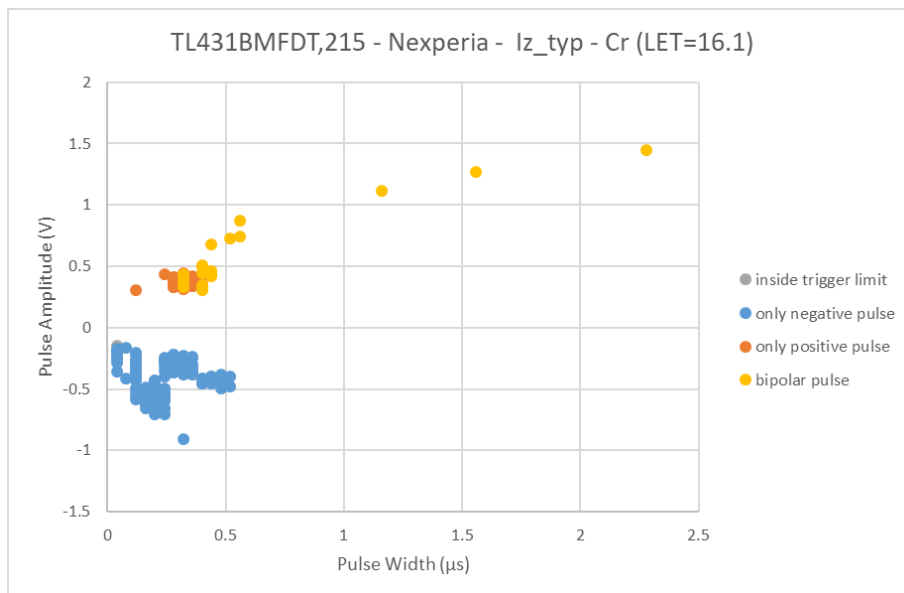
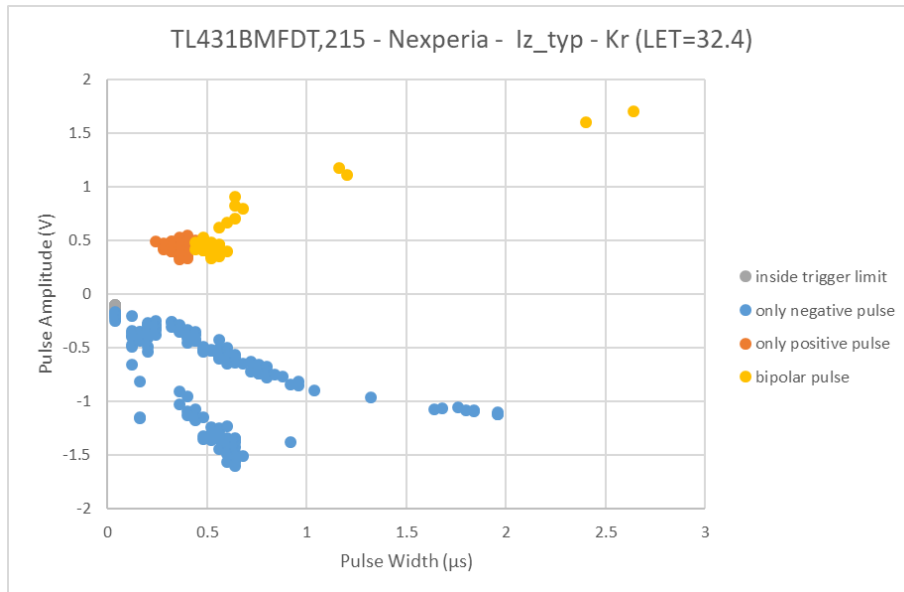

The last plot shows the second sample measured with the same condition at the lowest measured LET. It shows a very similar behaviour then the first sample.

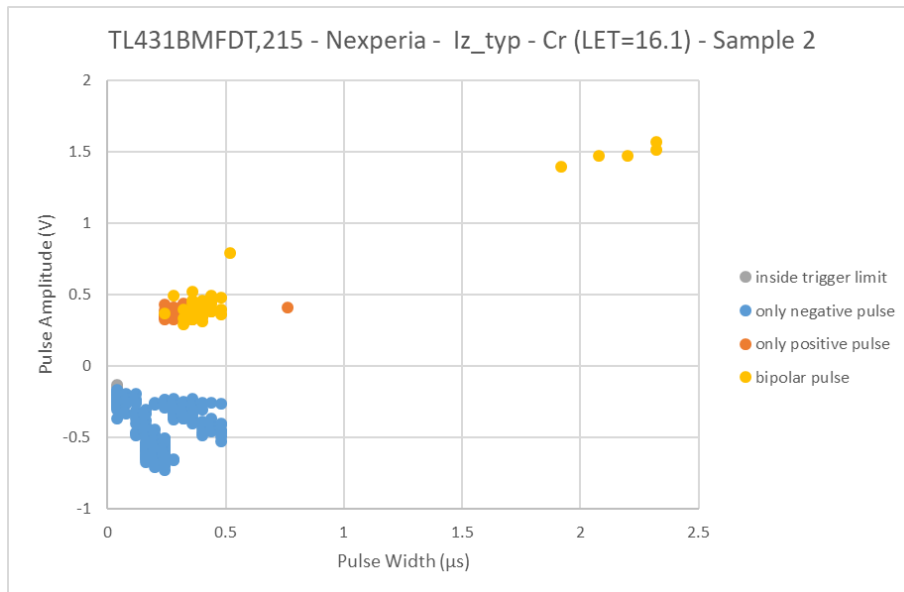

4.6 Pulse width compared

The following plots show a comparison of pulse amplitude and pulse width vs. Iz current values and the LET.

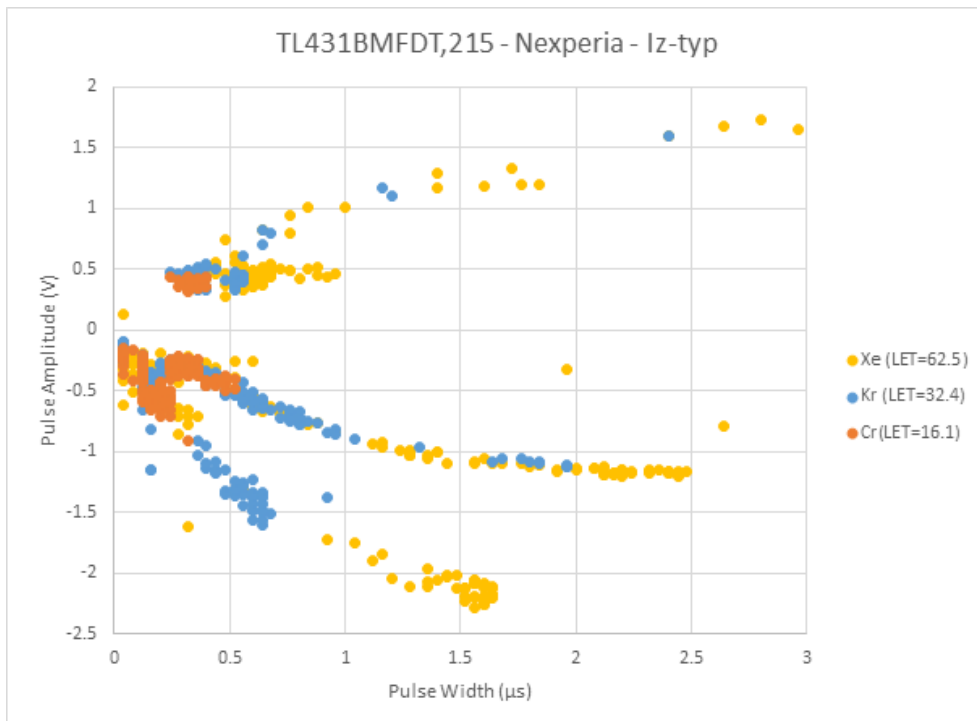
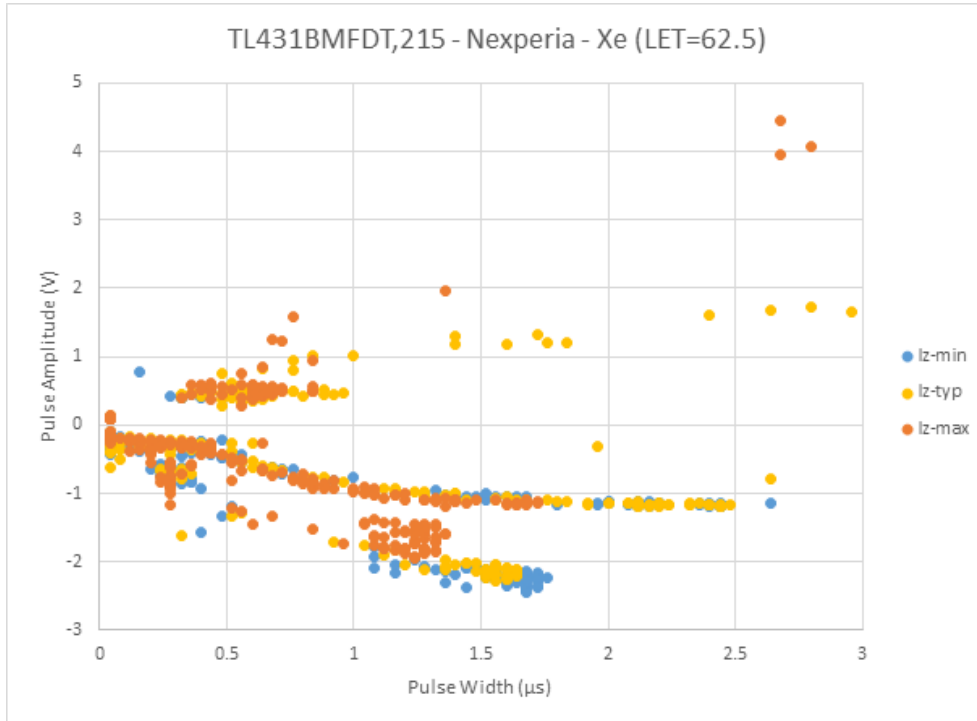

5 CONCLUSION

No destructive events were observed up to an LET of 62.5 MeV*cm²/mg. All transients were analysed and their amplitudes were plotted against their width.

It seems that at these LET above 16, the Iz has more impact on the SET profile than the LET.

If SETs up to 3 μs pulse width and amplitudes of 5V can be filtered by using hardware filter devices next to the component, then there is no SET impact from this device.

Most of the pulses are bipolar or only negative. Especially for the max current measurement, a high positive voltage pulse could be observed. This could come from inductance loops in the test setup and could possibly be mitigated by using a capacitance on the input of the reference.

The cross section of the component could be calculated with the measurements to around 3.4E-03 cm² at a LET of 62.5 MeV*cm²/mg.

At the LET of 62.5 it can be seen that the cross-section increased from 2E-3 to 3E-3 cm² by changing the anode-cathode voltage from 5V to 25.3V.

Finding the LET threshold for these SET events was not the scope of this campaign.