



ESA ESTEC
Keplerlaan 1
2201 AZ Noordwijk
The Netherlands

TS4061_TID_TEST_REPORT

TS4061AICT-1.25

Date Code: 2032

1.25V Bandgap Voltage Reference

STMicroelectronics

Prepared by Florian Krimmel

Document Type

Reference

Issue/Revision 1.0

Date of Issue 11/05/2022

Status Approved



APPROVAL

Title	TS4061_TID_test_report		
Issue Number	1	Revision Number	0
Author	Florian Kimmel	Date	11/05/2022
Approved By	Date of Approval		

CHANGE LOG

LM4040_TID_test_report	Issue Nr	Revision Number	Date
First issue of the report	1	0	11/05/2022

CHANGE RECORD

Issue Number	Revision Number	Date	Pages	Paragraph(s)
1	0	11/05/2022	All	All

DISTRIBUTION

Name/Organisational Unit



Table of Contents

1. Introduction	4
2. Documents	4
2.1. Applicable documents	4
2.2. Reference documents	4
3. Part & procurement information	5
4. DOSIMETRY and irradiation facility	7
5. Test set-up	7
5.1. Test set-up overview	7
5.2. Test equipment	9
6. test parameters	9
7. biasing conditions	9
8. TID results	10
8.1. TID RESULTS - TS4061AICT-1.25 - from ST - date code 2032	10
8.2. TID RESULTS - TS4061AICT-1.25 - from ST - date code unknown	12
8.3. Comparison Date Code	14
8.4. Comparison with other tested Bandgap References	15
9. Conclusion	17
ANNEX A – DATASHEET	18
ANNEX B – Set-up	19
ANNEX C – Radiation Test Summary – Irradiation Steps	23

1. INTRODUCTION

The current report presents the TID results on the Bandgap Voltage Reference TS4061

- TS4061AICT-1.25, date code: 2032, STMicroelectronics
- TS4061AICT-1.25, date code: unknown, STMicroelectronics

The test campaign was performed between the 24th January and 18th February 2022 at the ESTEC 60Co facility.

Additional information on the context is provided in the test plan [RD01].

2. DOCUMENTS

2.1. Applicable documents

AD01 ESCC22900 Total Dose Steady-state irradiation test method, June 2016

2.2. Reference documents

RD01 TID_COTS_Bandgap-ref_test_plan

RD02 RA0005344 Radiation Test Summary

3. PART & PROCUREMENT INFORMATION

Part number	TS4061AICT-1.25	
Manufacturer	STMicroelectronics	
Function	1.25V Bandgap Voltage Reference	
Technology	Bipolar	
Package		
Date Code [yyww]	2032	unknown
Distributor	Mouser	Farnell
Part #	5 samples unbiased (n° D40 to D44)	5 samples unbiased (n° D50 to D54)
(sample n°)		
date code	5 samples biased (n° D45 to D49)	5 samples biased (n° D55 to D59)
	1 reference unbiased (n° REF34)	1 reference unbiased (n° REF35)
	1 reference biased (n° REF84)	1 reference biased (n° REF85)

Table 1: Part & procurement information



Part number	TS4061AICT-1.25 Date code: 2032	TS4061AICT-1.25 Date code: unknown
Package marking top		
Package marking bottom		
X-ray top view		
X-ray side view		

Table 2: Package marking X-ray of the DUT

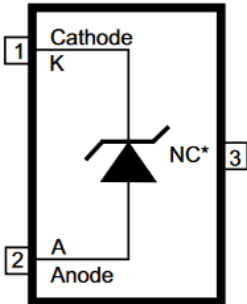

4. DOSIMETRY AND IRRADIATION FACILITY

IRRADIATION FACILITY

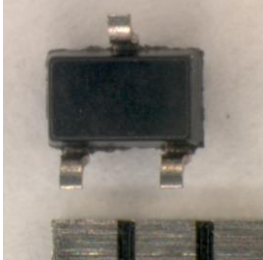
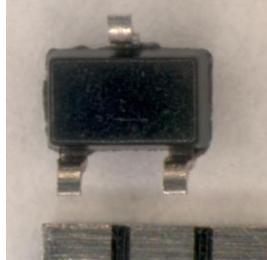
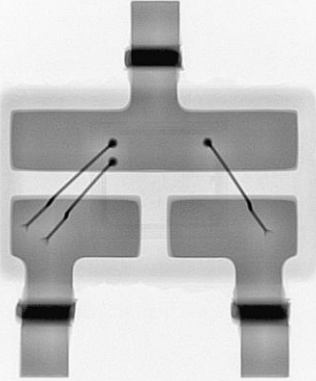
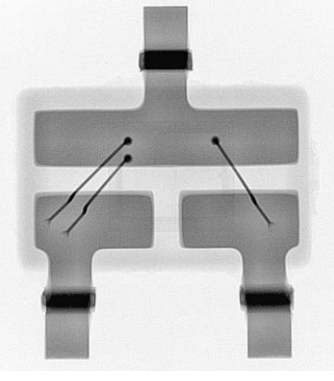
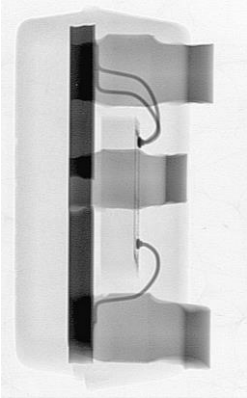
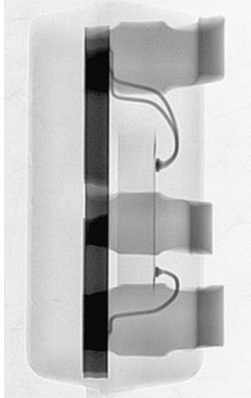
Source: C060
 Localization: ESTEC, Netherlands
 Dosimetry: Electrometer: Farmer model 2670 – s/n 491
 Ionisation chamber: PTW TW30012-10 s/n 000417

IRRADIATION TIMING

TID steps (krad(Si)) 0, 5, 10, 15, 20, 38.2, 50, 80.5, 100
 Dose rate (rad(Si)/h) 240 - 260

ANNEALING TIMING	Condition during annealing
Annealing 22°C 24 h	Biased for those tested biased Unbiased for those tested unbiased
Ageing 100°C 168h	ON for those tested ON Unbiased for those tested unbiased

Values are provided in TID(H₂O), the conversion to TID(Si) is done using the conversion factor of: 0.898.

5. TEST SET-UP

5.1. Test set-up overview

The set-up to measure at specific TID steps outside the irradiation chamber is schematically depicted in the Figure 1. Inside the radiation chamber the component boards with the DUTs on it are connected to the biasing boards which have a determined resistor to create the right value of biasing current (typical current acc. to datasheet) from a 12V supply for each biased component. Additionally to that, there are also 0-Ohm resistors on the biasing boards to connect all pins of the unbiased components.

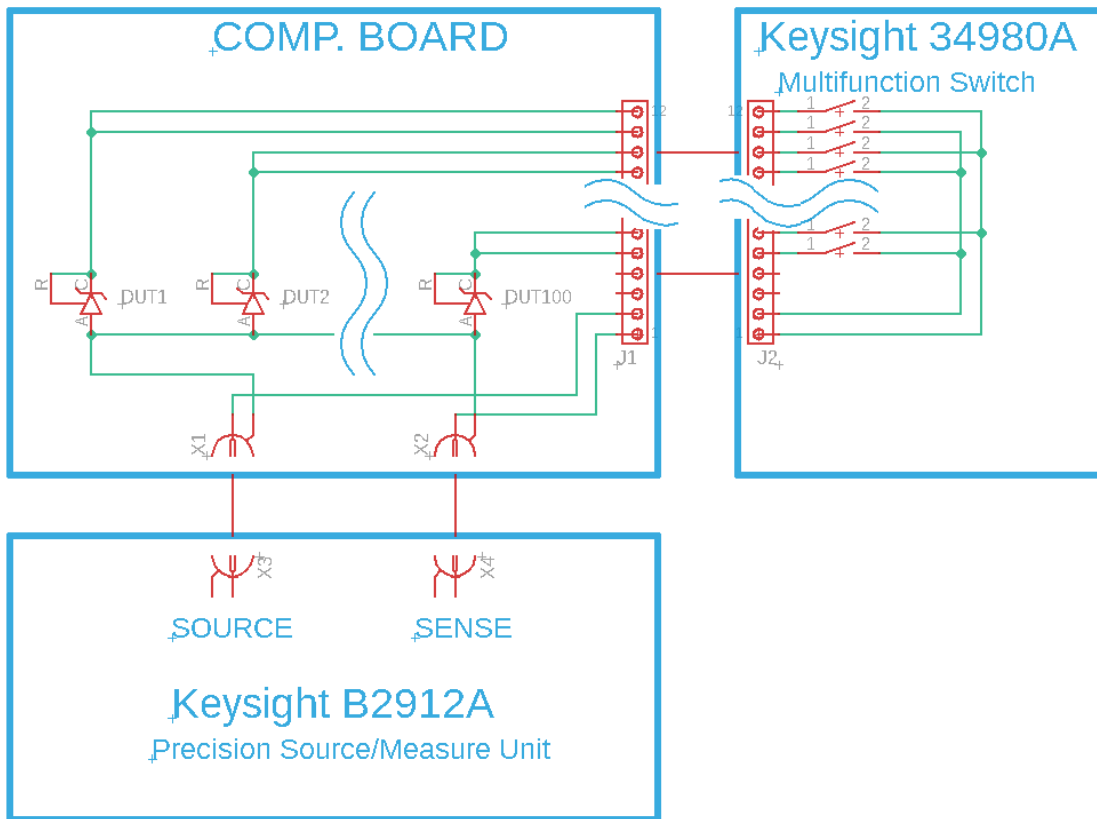

Figure 1: Simplified schematic of the overall test set-up

Four PCBs which were specially designed for this purpose could allow to accommodate both biased and unbiased components for this component and also other bandgap reference components at the same time on a 12 x 22 cm² PCB. This size of the boards limits the TID variation across board to less than 10%. Set-up pictures are provided in Annex B.

During each defined TID step a PC laptop was used to acquire the voltage (V_z) as well as the input current (I_z) of each of the samples from the source measure unit (SMU). The laptop time is synchronised to the time used for controlling the Co60 facility.



5.2. Test equipment

TEST EQUIPMENT	PARAMETER MEASURED
1 x Keysight B2912A 2412A Precision Source/Measure Unit (SMU)	Providing 6 different I_z currents acc. to datasheet of the components: $I_{min}, 0.8 \times I_{typ}, I_{typ}, 3.14 \times I_{typ}, 10 \times I_{typ}, I_{max}$ $V_{max} = 5.0 \text{ V}$
1 x Keysight 34980A Multifunction Switch	Switching through all up to 100 samples solder on one board.
1 x Laptop with LabView	Logging and saving the V_z and I_z measurements using an in-house VI.

6. TEST PARAMETERS

The following two parameters are measured:

PARAMETERS	SYMBOLS
Reverse Breakdown Voltage	V_z
Reverse Current	I_z

7. BIASING CONDITIONS

All biased samples are continuously biased with the typical value of I_z according to the datasheet of each part type:

Table summarised the main biasing conditions

PART TYPE	Value	Unit
TS4061AICT-1.25	10	μA

Table 2: Biasing conditions during irradiation



8. TID RESULTS

8.1. TID RESULTS - TS4061AICT-1.25 - from ST - date code 2032

TS4061AICT-1.25 - from ST - date code 2032 - @ I-min 10µA													
DUT No.	krad (Si)	0	5	10	15	20	38.2	50	80.5	100	Room Temp. annealing	100°C annealing	
D40	unbiased	1.2491	1.2491	1.2491	1.2491	1.2492	1.2492	1.2492	1.2491	1.2490	1.2491	1.2484	
D41		1.2498	1.2498	1.2498	1.2499	1.2499	1.2499	1.2498	1.2498	1.2497	1.2497	1.2494	
D42		1.2488	1.2488	1.2488	1.2488	1.2488	1.2489	1.2489	1.2488	1.2488	1.2488	1.2487	1.2483
D43		1.2494	1.2493	1.2493	1.2493	1.2494	1.2494	1.2494	1.2494	1.2494	1.2494	1.2493	1.2490
D44		1.2487	1.2486	1.2486	1.2486	1.2487	1.2487	1.2486	1.2486	1.2486	1.2486	1.2485	1.2479
D45	biased	1.2495	1.2495	1.2494	1.2494	1.2494	1.2494	1.2493	1.2492	1.2491	1.2491	1.2486	
D46		1.2493	1.2493	1.2492	1.2492	1.2493	1.2492	1.2492	1.2491	1.2490	1.2490	1.2483	
D47		1.2502	1.2501	1.2501	1.2501	1.2501	1.2501	1.2501	1.2500	1.2499	1.2498	1.2489	
D48		1.2488	1.2487	1.2486	1.2486	1.2487	1.2487	1.2486	1.2485	1.2485	1.2485	1.2479	
D49		1.2489	1.2489	1.2489	1.2489	1.2489	1.2489	1.2490	1.2488	1.2487	1.2487	1.2481	
REF34	Ref unbiased	1.2486	1.2487	1.2486	1.2486	1.2486	1.2486	1.2486	1.2486	1.2486	1.2487	1.2486	
REF84	Ref biased	1.2485	1.2485	1.2485	1.2485	1.2485	1.2485	1.2485	1.2485	1.2485	1.2485	1.2485	

TS4061AICT-1.25 - from ST - date code 2032 - @ I-typ 10µA													
											Limit acc. DS: Vz = 1.25V ± 0.33% (1.2459V – 1.2541V)		
DUT No.	krad (Si)	0	5	10	15	20	38.2	50	80.5	100	Room Temp. annealing	100°C annealing	
D40	unbiased	1.2491	1.2491	1.2491	1.2491	1.2492	1.2492	1.2492	1.2491	1.2490	1.2490	1.2484	
D41		1.2498	1.2498	1.2498	1.2499	1.2499	1.2499	1.2498	1.2498	1.2497	1.2497	1.2494	
D42		1.2488	1.2488	1.2488	1.2488	1.2489	1.2489	1.2489	1.2488	1.2488	1.2488	1.2487	1.2483
D43		1.2493	1.2493	1.2493	1.2494	1.2494	1.2494	1.2494	1.2494	1.2493	1.2493	1.2493	
D44		1.2487	1.2486	1.2486	1.2486	1.2487	1.2487	1.2486	1.2486	1.2486	1.2486	1.2485	1.2479
D45	biased	1.2495	1.2495	1.2494	1.2494	1.2494	1.2494	1.2493	1.2492	1.2491	1.2491	1.2486	
D46		1.2493	1.2493	1.2492	1.2492	1.2493	1.2492	1.2492	1.2491	1.2490	1.2490	1.2483	
D47		1.2502	1.2501	1.2501	1.2501	1.2501	1.2501	1.2501	1.2500	1.2498	1.2498	1.2489	
D48		1.2488	1.2487	1.2486	1.2486	1.2487	1.2487	1.2486	1.2486	1.2485	1.2485	1.2479	
D49		1.2490	1.2489	1.2489	1.2489	1.2489	1.2489	1.2490	1.2488	1.2487	1.2487	1.2481	
REF34	Ref unbiased	1.2486	1.2487	1.2486	1.2486	1.2486	1.2486	1.2486	1.2486	1.2487	1.2487	1.2486	
REF84	Ref biased	1.2485	1.2485	1.2485	1.2485	1.2485	1.2485	1.2485	1.2485	1.2485	1.2485	1.2485	

TS4061AICT-1.25 - from ST - date code 2032 - @ I-max 15mA												
DUT No.	krad (Si)	0	5	10	15	20	38.2	50	80.5	100	Room Temp. annealing	100°C annealing
D40	unbiased	1.2511	1.2510	1.2510	1.2511	1.2511	1.2512	1.2511	1.2510	1.2510	1.2510	1.2503
D41		1.2516	1.2516	1.2517	1.2517	1.2518	1.2517	1.2517	1.2517	1.2515	1.2515	1.2513
D42		1.2507	1.2506	1.2506	1.2507	1.2507	1.2508	1.2507	1.2507	1.2506	1.2506	1.2502
D43		1.2513	1.2512	1.2513	1.2513	1.2513	1.2514	1.2513	1.2513	1.2513	1.2513	1.2510
D44		1.2506	1.2505	1.2506	1.2506	1.2506	1.2506	1.2506	1.2505	1.2505	1.2505	1.2499
D45	biased	1.2514	1.2513	1.2513	1.2513	1.2513	1.2512	1.2512	1.2511	1.2510	1.2510	1.2504
D46		1.2512	1.2512	1.2511	1.2511	1.2511	1.2511	1.2511	1.2510	1.2509	1.2509	1.2502
D47		1.2521	1.2520	1.2520	1.2520	1.2521	1.2521	1.2520	1.2519	1.2518	1.2518	1.2509
D48		1.2507	1.2506	1.2505	1.2505	1.2506	1.2506	1.2505	1.2505	1.2505	1.2504	1.2498
D49		1.2509	1.2508	1.2508	1.2508	1.2508	1.2509	1.2509	1.2508	1.2507	1.2507	1.2501
REF34	Ref unbiased	1.2506	1.2506	1.2506	1.2505	1.2505	1.2505	1.2505	1.2506	1.2506	1.2506	1.2505
REF84	Ref biased	1.2505	1.2504	1.2504	1.2504	1.2504	1.2504	1.2504	1.2504	1.2504	1.2505	1.2504

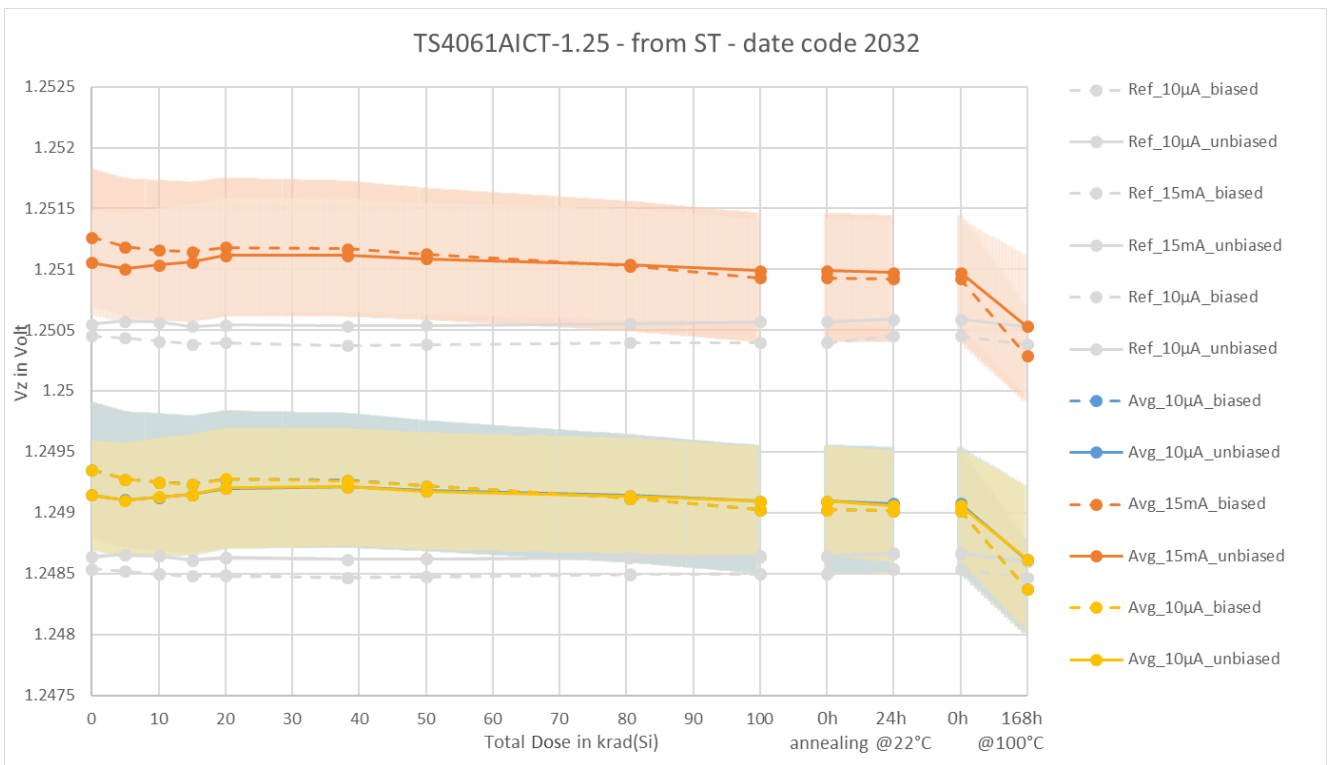

For all curves, which show an average over all measured samples, the coloured interval behind the curves represent +/- one standard deviation.



8.2. TID RESULTS - TS4061AICT-1.25 - from ST - date code unknown

TS4061AICT-1.25 - from ST - @ I-min 10µA												
DUT No.	krad (Si)	0	5	10	15	20	38.2	50	80.5	100	Room Temp. annealing	100°C annealing
D50	unbiased	1.2497	1.2497	1.2497	1.2497	1.2498	1.2499	1.2499	1.2499	1.2498	1.2498	1.2494
D51		1.2491	1.2491	1.2491	1.2492	1.2492	1.2492	1.2492	1.2490	1.2490	1.2490	1.2487
D52		1.2492	1.2491	1.2492	1.2492	1.2492	1.2492	1.2491	1.2491	1.2490	1.2489	1.2488
D53		1.2502	1.2501	1.2502	1.2502	1.2503	1.2503	1.2503	1.2503	1.2502	1.2502	1.2495
D54		1.2494	1.2494	1.2494	1.2494	1.2495	1.2496	1.2496	1.2495	1.2495	1.2494	1.2487
D55	biased	1.2492	1.2491	1.2491	1.2491	1.2491	1.2491	1.2491	1.2490	1.2489	1.2489	1.2482
D56		1.2491	1.2491	1.2491	1.2491	1.2492	1.2492	1.2492	1.2490	1.2489	1.2489	1.2485
D57		1.2491	1.2491	1.2490	1.2489	1.2489	1.2489	1.2489	1.2487	1.2486	1.2486	1.2482
D58		1.2497	1.2497	1.2496	1.2496	1.2497	1.2497	1.2497	1.2496	1.2495	1.2496	1.2489
D59		1.2496	1.2495	1.2495	1.2496	1.2496	1.2497	1.2497	1.2496	1.2495	1.2495	1.2489
REF35	Ref unbiased	1.2502	1.2502	1.2502	1.2502	1.2502	1.2502	1.2502	1.2502	1.2502	1.2502	1.2502
REF85	Ref biased	1.2484	1.2484	1.2484	1.2483	1.2483	1.2483	1.2483	1.2483	1.2483	1.2484	1.2483

TS4061AICT-1.25 - from ST - @ I-tp 10µA Limit acc. DS: Vz = 1.25V ± 0.33% (1.2459V – 1.2541V)												
DUT No.	krad (Si)	0	5	10	15	20	38.2	50	80.5	100	Room Temp. annealing	100°C annealing
D50	unbiased	1.2497	1.2497	1.2497	1.2497	1.2498	1.2499	1.2499	1.2499	1.2498	1.2498	1.2494
D51		1.2491	1.2491	1.2491	1.2492	1.2492	1.2492	1.2492	1.2490	1.2490	1.2489	1.2487
D52		1.2492	1.2491	1.2492	1.2492	1.2492	1.2492	1.2491	1.2491	1.2490	1.2489	1.2488
D53		1.2502	1.2501	1.2502	1.2502	1.2503	1.2503	1.2503	1.2503	1.2502	1.2501	1.2495
D54		1.2494	1.2494	1.2494	1.2494	1.2495	1.2496	1.2496	1.2495	1.2495	1.2494	1.2487
D55	biased	1.2492	1.2491	1.2491	1.2491	1.2491	1.2491	1.2491	1.2490	1.2489	1.2489	1.2482
D56		1.2491	1.2491	1.2491	1.2491	1.2492	1.2492	1.2491	1.2490	1.2489	1.2489	1.2485
D57		1.2491	1.2491	1.2490	1.2489	1.2489	1.2489	1.2489	1.2487	1.2486	1.2486	1.2482
D58		1.2497	1.2496	1.2496	1.2496	1.2497	1.2497	1.2497	1.2496	1.2496	1.2496	1.2489
D59		1.2496	1.2495	1.2495	1.2496	1.2496	1.2497	1.2497	1.2496	1.2495	1.2494	1.2489
REF35	Ref unbiased	1.2502	1.2502	1.2502	1.2502	1.2502	1.2502	1.2502	1.2502	1.2502	1.2502	1.2502
REF85	Ref biased	1.2484	1.2484	1.2484	1.2483	1.2483	1.2483	1.2483	1.2483	1.2483	1.2484	1.2483

TS4061AICT-1.25 - from ST - @ I-max 15mA												
DUT No.	krad (Si)	0	5	10	15	20	38.2	50	80.5	100	Room Temp. annealing	100°C annealing
D50	unbiased	1.2515	1.2515	1.2515	1.2515	1.2516	1.2517	1.2517	1.2517	1.2516	1.2516	1.2512
D51		1.2510	1.2510	1.2511	1.2511	1.2512	1.2512	1.2512	1.2510	1.2509	1.2509	1.2507
D52		1.2510	1.2510	1.2510	1.2510	1.2511	1.2511	1.2510	1.2509	1.2508	1.2508	1.2507
D53		1.2521	1.2521	1.2521	1.2521	1.2522	1.2522	1.2522	1.2522	1.2521	1.2521	1.2515
D54		1.2514	1.2514	1.2514	1.2514	1.2515	1.2516	1.2516	1.2515	1.2515	1.2514	1.2507
D55	biased	1.2511	1.2511	1.2510	1.2511	1.2511	1.2511	1.2510	1.2509	1.2508	1.2509	1.2502
D56		1.2510	1.2510	1.2510	1.2510	1.2511	1.2511	1.2511	1.2510	1.2509	1.2508	1.2504
D57		1.2511	1.2510	1.2510	1.2509	1.2509	1.2509	1.2508	1.2507	1.2506	1.2505	1.2501
D58		1.2516	1.2515	1.2515	1.2515	1.2516	1.2516	1.2516	1.2515	1.2514	1.2515	1.2508
D59		1.2515	1.2514	1.2515	1.2515	1.2515	1.2517	1.2516	1.2515	1.2514	1.2514	1.2508
REF35	Ref unbiased	1.2521	1.2521	1.2521	1.2521	1.2521	1.2521	1.2521	1.2521	1.2521	1.2521	1.2521
REF85	Ref biased	1.2503	1.2503	1.2503	1.2503	1.2502	1.2502	1.2502	1.2502	1.2502	1.2503	1.2502

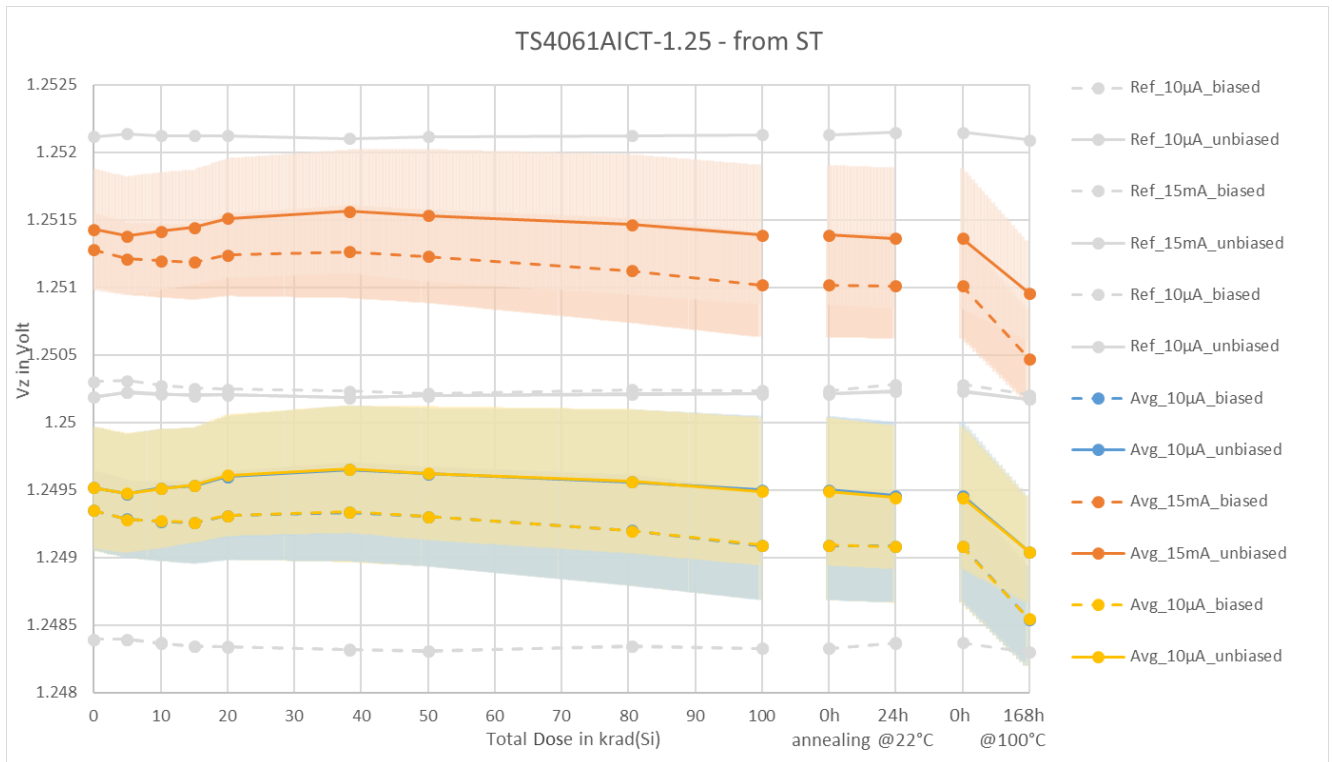

8.3. Comparison Date Code

The following graph shows the different behaviour of all measured TS4061 voltage references with different date codes.

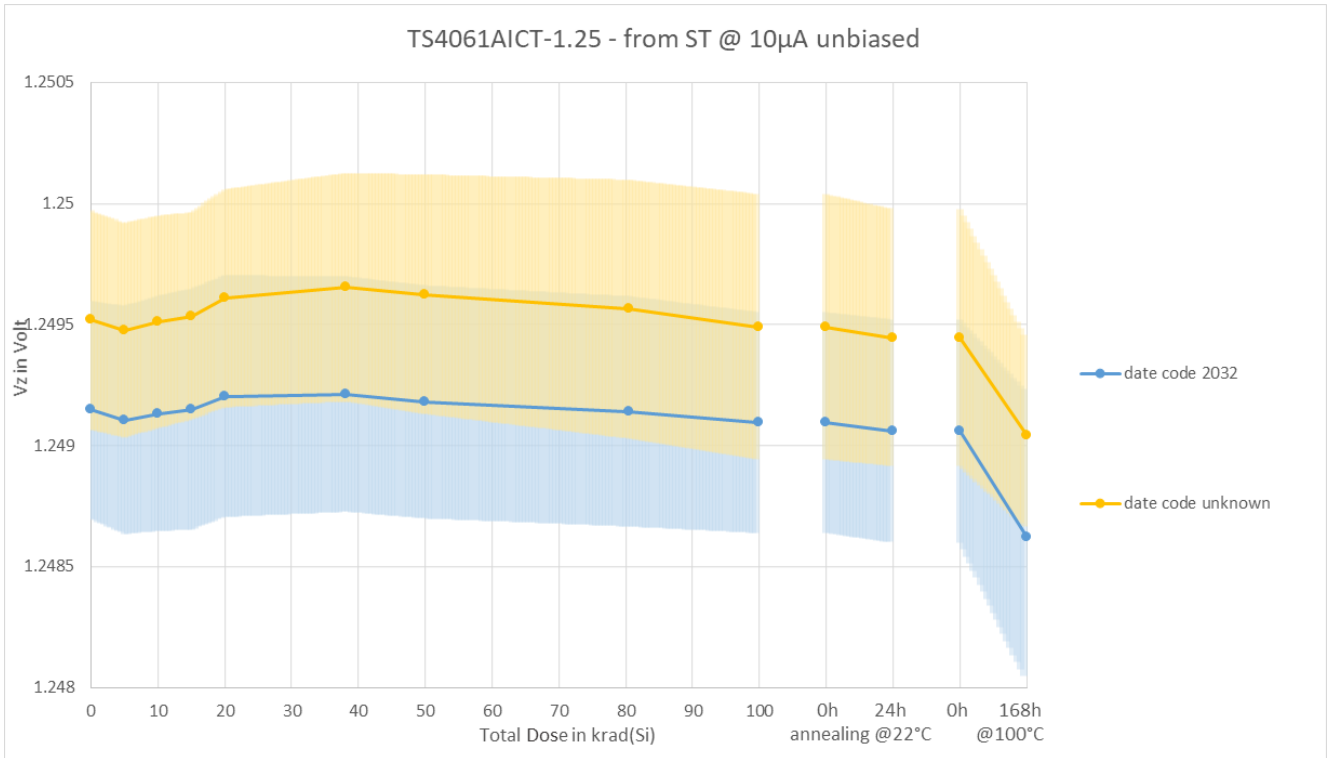

All curves plotted show the average value of all unbiased tested samples (worst case) and the interval behind the curves represent +/- one standard deviation.

8.4. Comparison with other tested Bandgap References

The following four graphs show the results of the TS4061 Bandgap Voltage References compared to different Bandgap References part types, which were tested at the same time with the same test setup than the TS4061. Additional information on these tests is provided in the Radiation Test Summary [RD02].

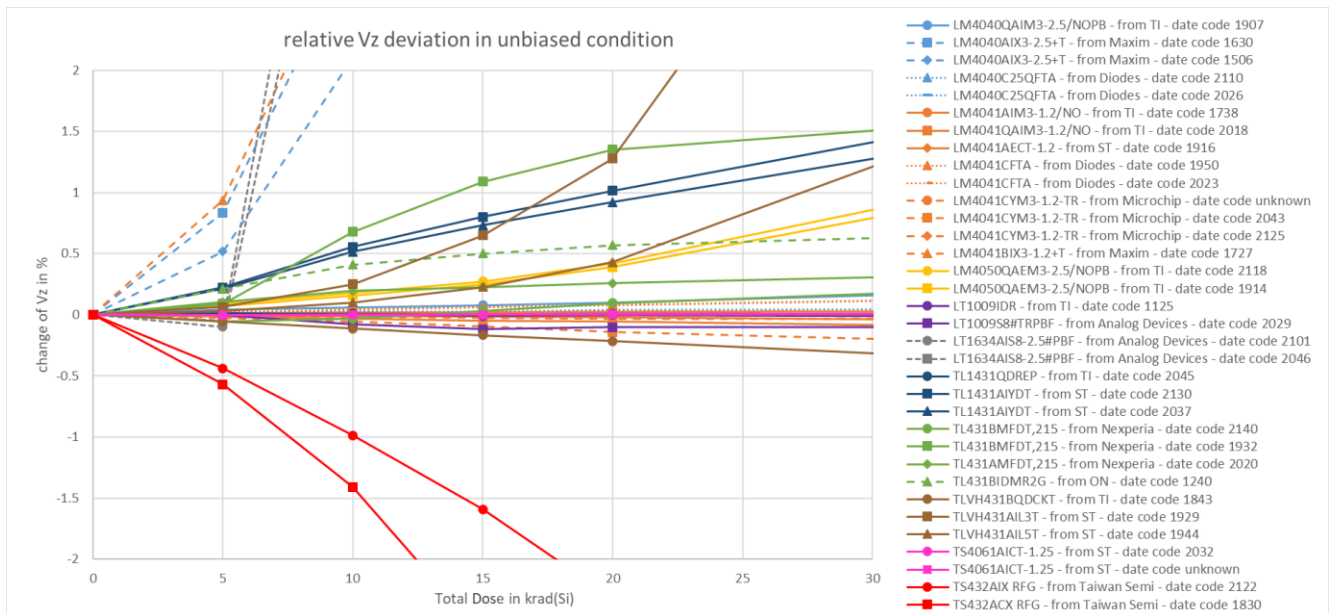
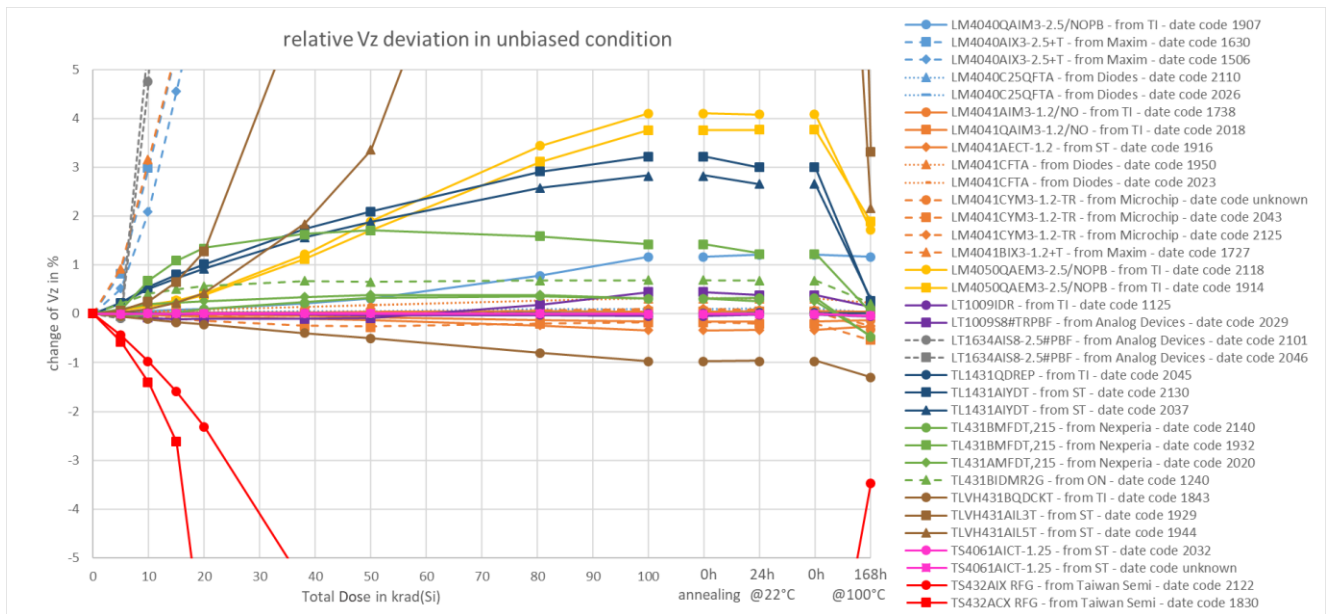

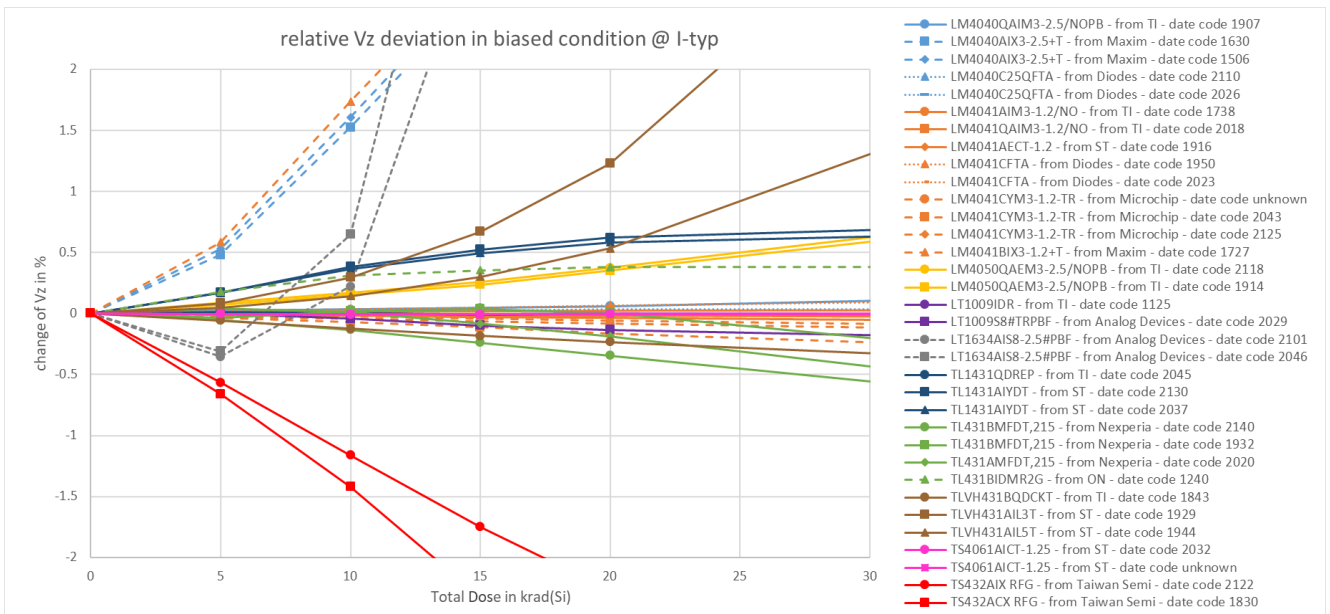
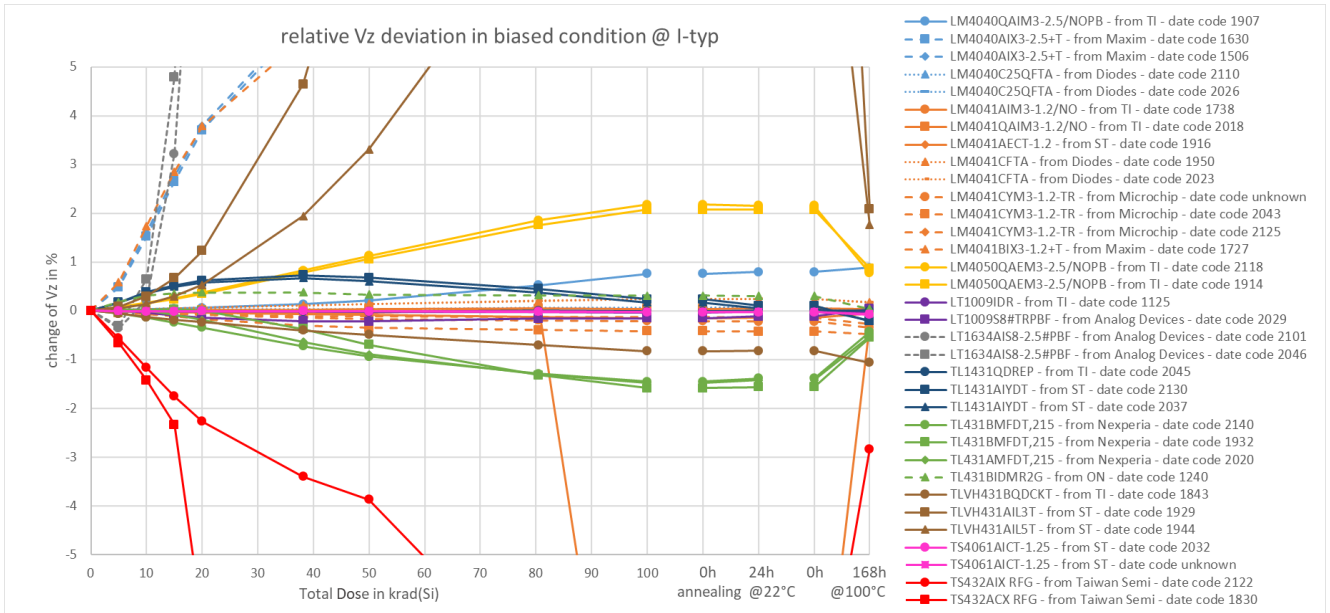

9. CONCLUSION

All tested components with different date codes and from different manufacturers stayed inside specification limits up to a dose around 100 krad.

The deviation of tested components from the two different date codes shows a very similar behaviour in respect of TID effects.

In general, a higher deviation was found for the samples in biased condition.



ANNEX A – DATASHEET

Part Type	Manufacturer	Link to Datasheet
TS4061AICT-1.25	STMicroelectronics	https://www.st.com/content/ccc/resource/technical/document/datasheet/99/0a/06/84/6d/21/40/45/DM00114435.pdf/files/DM00114435.pdf/jcr:content/translations/en.DM00114435.pdf

ANNEX B – SET-UP

Test board front- and backside with the TLVH431 on position 40 to 59 on board D:

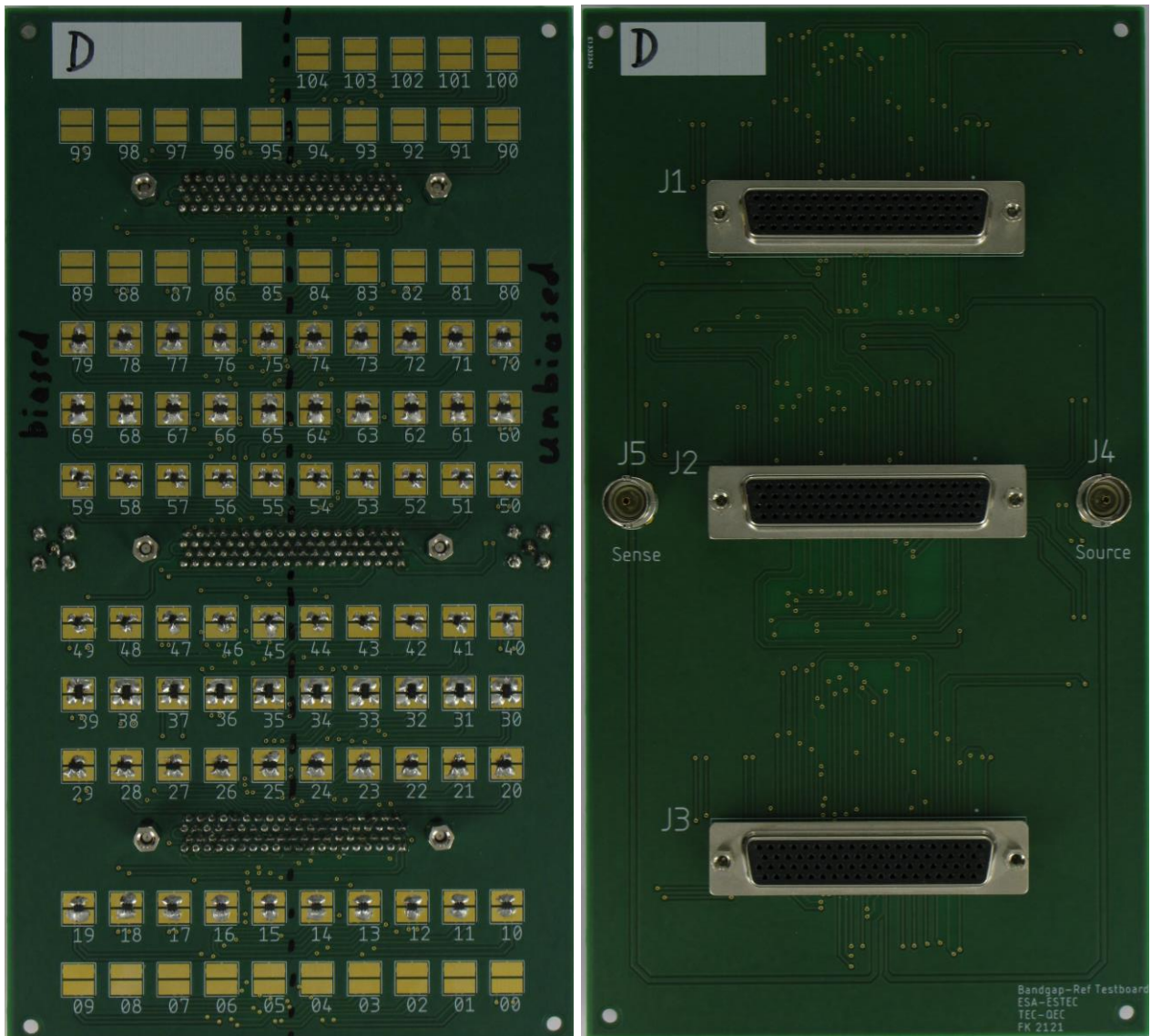

Biassing board front- and backside with the biasing resistors on it:

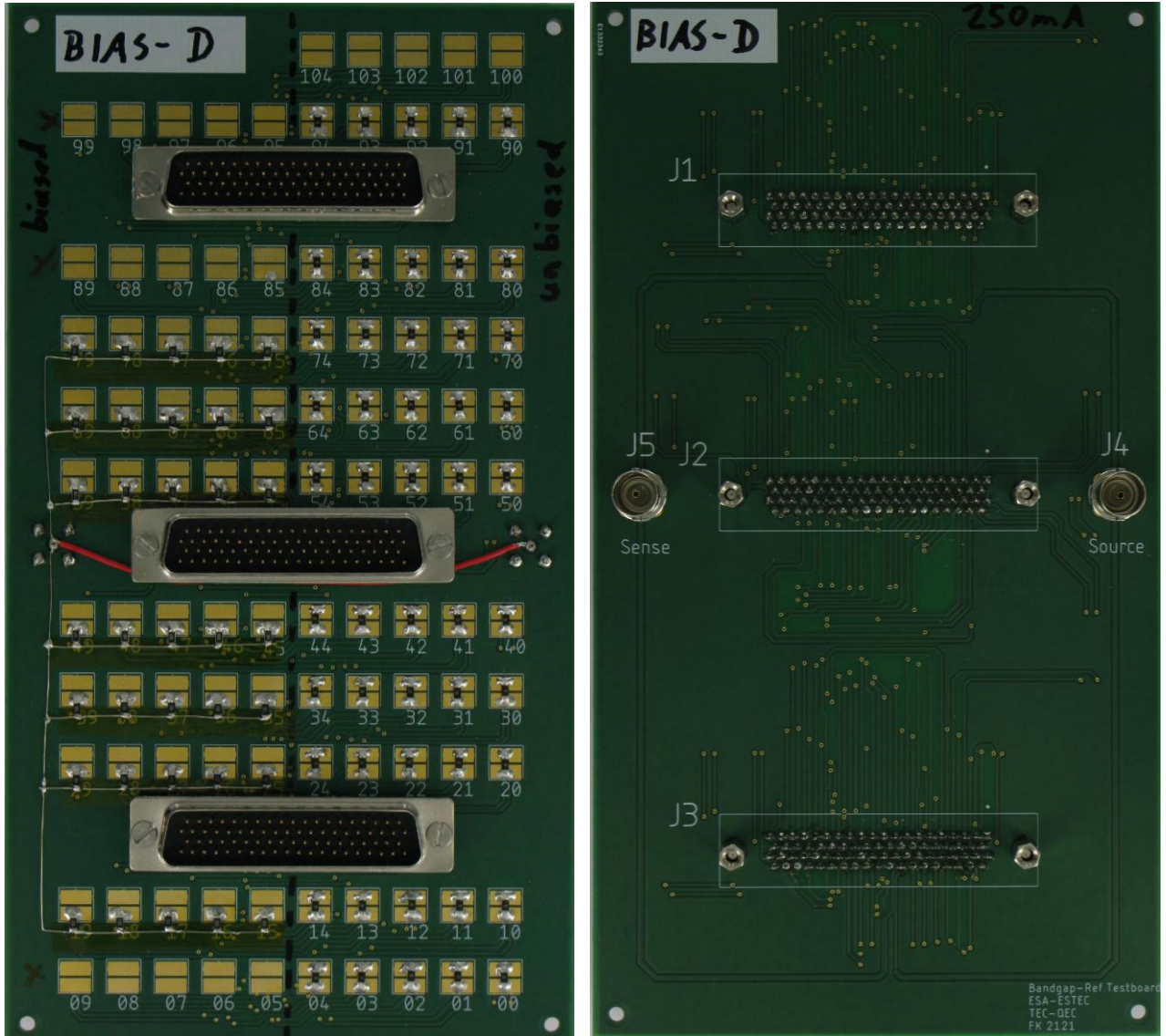

Measurement setup with the cable connection from the Test Board to the Switching Matrix and the Source Measure Unit:

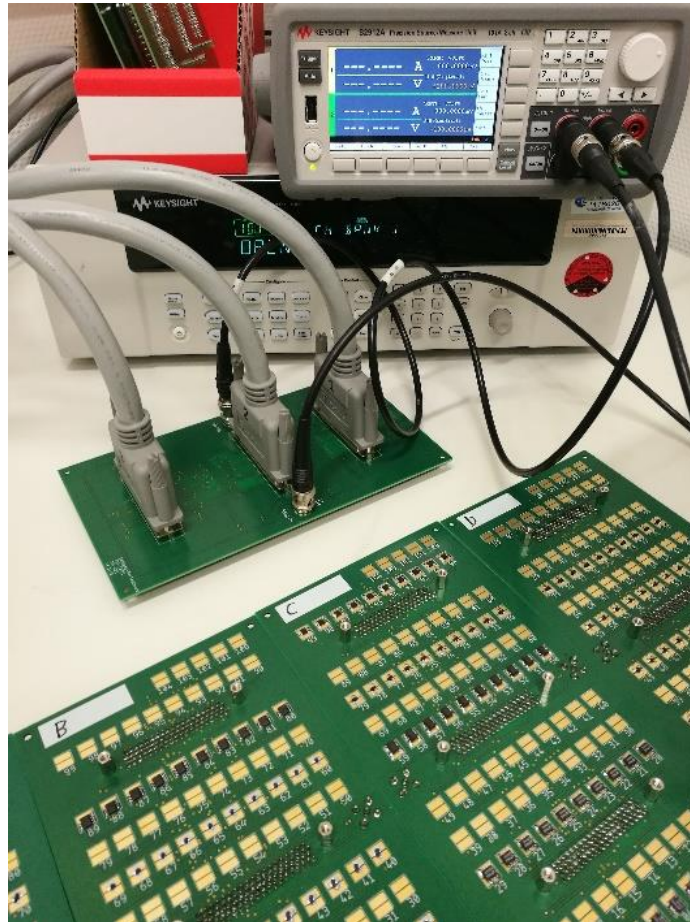

Position of the boards inside the Co60 irradiation chamber:

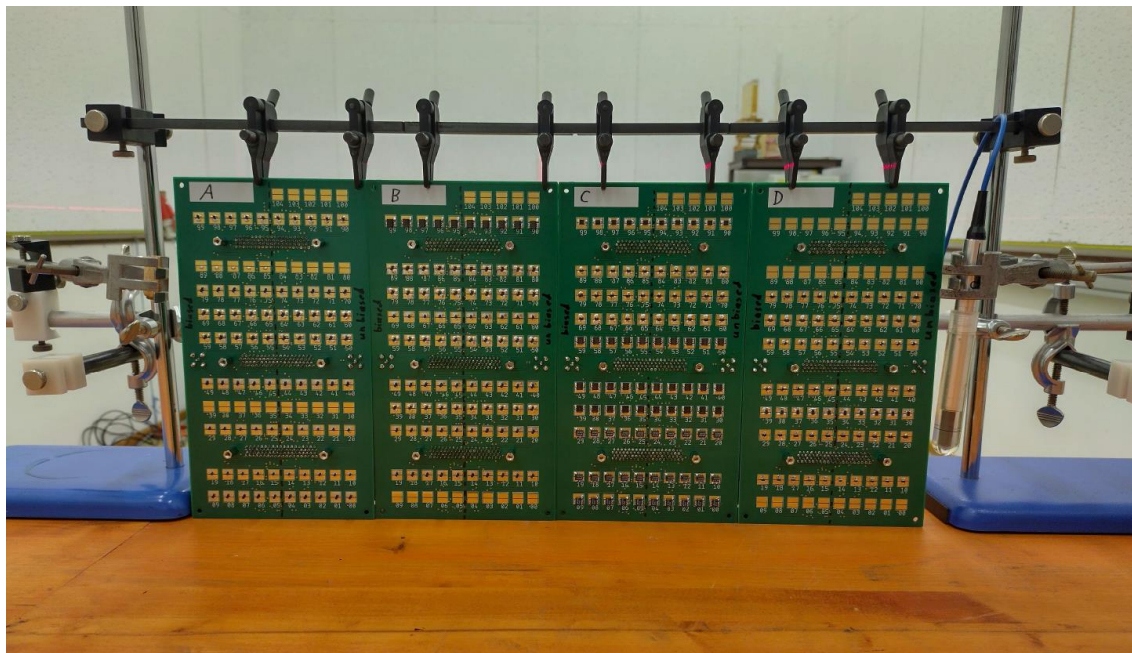
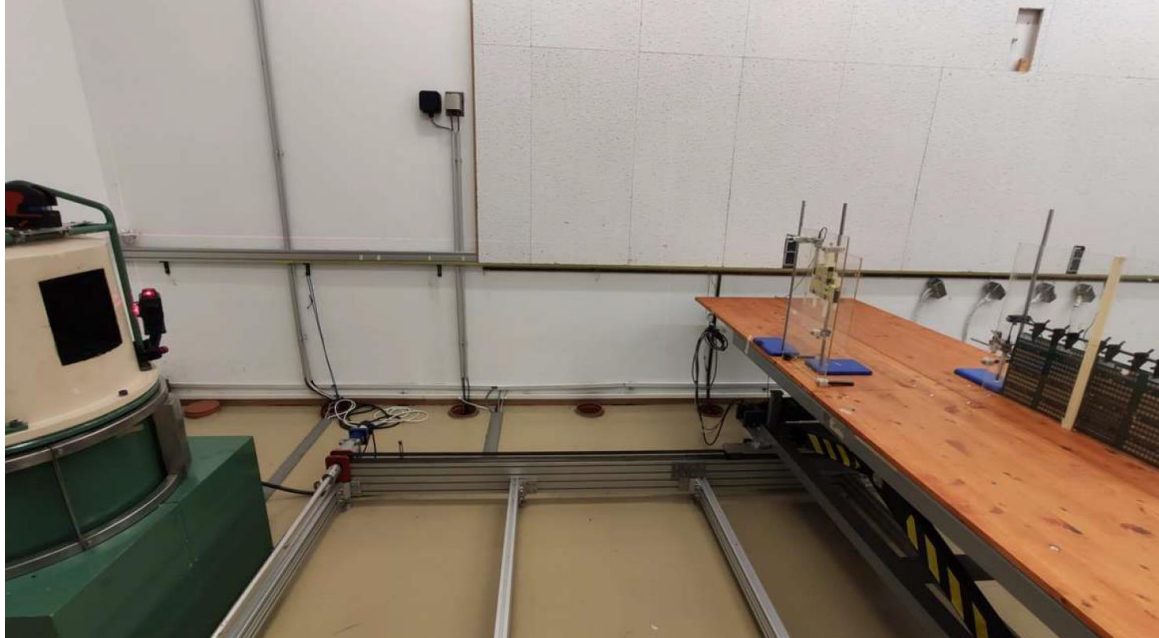

ANNEX C – RADIATION TEST SUMMARY – IRRADIATION STEPS

Irr. Run	Start Date & Time (CET)	End Date & Time (CET)	Total Ionising Dose (water)	Dose Rate (water)
1	24-01-2022 18:11:39	25-01-2022 13:37:10	55.69 Gy	2.867 Gy/h
2	25-01-2022 15:13:42	26-01-2022 11:52:43	55.67 Gy	2.696 Gy/h
3	26-01-2022 13:30:18	27-01-2022 10:16:45	55.68 Gy	2.680 Gy/h
4	27-01-2022 12:11:47	28-01-2022 08:55:59	55.68 Gy	2.685 Gy/h
5	28-01-2022 10:31:55	31-01-2022 09:30:00	202.3 Gy	2.851 Gy/h
6	31-01-2022 11:18:44	02-02-2022 09:21:12	131.8 Gy	2.863 Gy/h
7	02-02-2022 11:05:44	07-02-2022 09:55:08	339.6 Gy	2.858 Gy/h
8	07-02-2022 11:41:36	10-02-2022 15:46:14	217.1 Gy	2.854 Gy/h
Total			1.114 kGy	

Note: The uncertainty budgets (according to TEC-QEC/PR001 section 12) are: 4.2 % (k=2) for absorbed dose to water and 4.4% (k=2) for absorbed dose rate to water

	units	Min.	Max.	Time-weighted Average
Temperature	°C	20.9	21.2	20.93
Pressure	mbar	996.6	1034.5	1019.01
Relative Humidity	%	47.1	54	51.45

Dosimeter position relative to ⁶⁰ Co source		
X	cm	36.5
Y	cm	292
Z	cm	-21

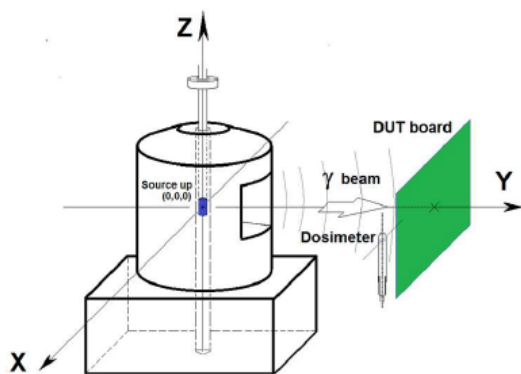

Figure 1 Co-60 irradiator head and board positioning sketch

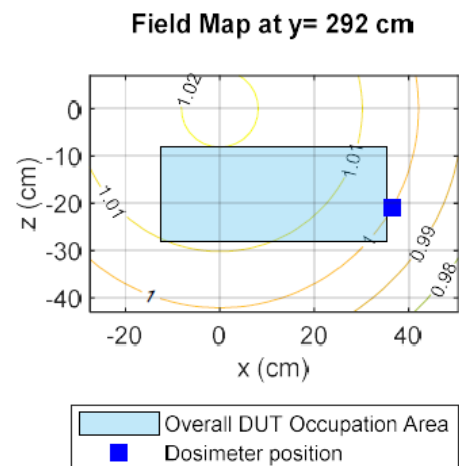

Figure 2: Qualitative indication of dose rate distribution normalized to dosimeter readings. Axes origin located at source centre. Graphs for information only, of the run with highest dose rate.