

**SINGLE EVENT EFFECTS
TEST REPORT**

Test Type:	Heavy ion
Test facility:	RADEF, JYFL, University of Jyvaskyla, Jyvaskyla, Finland
Test Date:	October 2014
Part Type:	ADS1278
Part Description:	Octal, Simultaneous Sampling, 24-Bit Analog-to-Digital Converter
Part Manufacturer:	Texas Instruments

ESA contract n° 4000105495/12/NL/SFe dated 27/2/2012

Hirex reference :	HRX/SEE/502	Issue : 02	Date :	January 13 2016
Written by :	Benjamin Crouzat	Design Engineer		
Authorized by:	F.X. Guerre			

DOCUMENTATION CHANGE NOTICE

Issue	Date	Page	Change Item	
01	14/09/2015	All	Original issue	
02	13/01/2016	All	As per Esa comments	

Contributors to this work:

Benjamin Crouzat
Frédéric Lochon

Hirex Engineering

SEE TEST REPORT

TABLE OF CONTENTS

1	GLOSSARY	4
2	INTRODUCTION	5
3	APPLICABLE AND REFERENCE DOCUMENTS.....	5
3.1	APPLICABLE DOCUMENTS	5
3.2	REFERENCE DOCUMENTS	5
4	DEVICE INFORMATION	6
4.1	DEVICE DESCRIPTION.....	6
4.2	SAMPLE PREPARATION.....	6
4.3	SAMPLE IDENTIFICATION	7
5	RADEF FACILITY	8
6	TEST SET-UP.....	9
7	TEST METHODS.....	11
8	ERROR DETECTION AND RECORDING.....	11
8.1	WAVE GENERATION HARDWARE.....	12
9	BIAS CONDITIONS	12
10	SEE TEST RESULTS	13
10.1	SEL	13
10.2	SET	13

LIST OF FIGURES

Figure 1:	ADS1278 device identification.....	7
Figure 2:	ADS1278, Heavy ion test set-up	9
Figure 3:	Daughter board (DIB257A) photo.....	9
Figure 4:	Daughter board schematic detail.....	10
Figure 5 –	Wave generation schematic	12
Figure 6 –	Bias conditions	12
Figure 7 –	SET amplitude and duration.....	14
Figure 8 –	Digital output waveforms captured with the 3 different methods.....	15
Figure 9 –	radef, October 2014, SET event cross-section for the three test methods.....	17
Figure 10 –	SET event cross-section with all runs cumulated per LET value	18
Figure 11 –	RADEF, October 2014, ADS1278 events distribution, 4 points and beat frequency	19
Figure 12 –	RADEF, October 2014, ADS1278 events distribution, hirex method and all methods	20
Figure 13 –	RADEF, October 2014, SET events examples, high amplitude small duration	21
Figure 14 –	RADEF, October 2014, SET events examples, high amplitude and high duration.....	22
Figure 15 –	RADEF, October 2014, SET events examples, medium amplitude and duration	23
Figure 16 –	RADEF, October 2014, SET events examples, very long duration	24

LIST OF TABLES

Table 1 –	Ion beam setting	8
Table 2 –	RADEF, October2014 (W44), ADS1278, run table	16

1 Glossary

DUT: Device under test.

Fluence (of particle radiation incident on a surface): The total amount of particle radiant energy incident on a surface in a given period of time, divided by the area of the surface.
In this document, Fluence is expressed in ions per cm².

Flux: The time rate of flow of particle radiant energy incident on a surface, divided by the area of that surface.
In this document, Flux is expressed in ions per cm²*s.

Single-Event Effect (SEE): Any measurable or observable change in state or performance of a microelectronic device, component, subsystem, or system (digital or analog) resulting from a single energetic particle strike.
Single-event effects include single-event upset (SEU), multiple-bit upset (MBU), multiple-cell upset (MCU), single-event functional interrupt (SEFI), single-event latch-up (SEL).

Single-Event Transient (SET): A soft error caused by the transient signal induced by a single energetic particle strike.

Single-Event Latch-up (SEL): An abnormal high-current state in a device caused by the passage of a single energetic particle through sensitive regions of the device structure and resulting in the loss of device functionality.

SEL may cause permanent damage to the device. If the device is not permanently damaged, power cycling of the device (off and back on) is necessary to restore normal operation.

An example of SEL in a CMOS device is when the passage of a single particle induces the creation of parasitic bipolar (p-n-p-n) shorting of power to ground.

Single-Event Latch-up (SEL) cross-section: the number of events per unit fluence. For chip SEL cross-section, the dimensions are cm² per chip.

Error cross-section: the number of errors per unit fluence. For device error cross-section, the dimensions are cm² per device. For bit error cross-section, the dimensions are cm² per bit.

Tilt angle: tilt angle, rotation axis of the DUT board is perpendicular to the beam axis; roll angle, board rotation axis is parallel to the beam axis

Weibull fit: $F(x) = A (1 - \exp\{-[(x-x_0)/W]^s\})$ with:

x = effective LET in MeV/(mg/cm²);

$F(x)$ = SEE cross-section in cm²;

A = limiting or plateau cross-section;

x_0 = onset parameter, such that $F(x) = 0$ for $x < x_0$;

W = width parameter;

s = a dimensionless exponent.

Error bars: error bars are computed using a confidence level of 95% and a beam flux uncertainty of +/-10% as recommended by Single Event Effects Test method and Guidelines ESA/SCC basic specification No 25100.

2 Introduction

This report presents the results of Heavy Ions test program carried out on Octal, Simultaneous Sampling, 24-Bit Analog-to-Digital Converter ADS1278 part type from Texas Instruments.

4 ADS1278 samples were used for heavy ions testing at RADEF, JYFL, University of Jyväskylä, Jyväskylä, Finland.

This work was performed for ESA under ESA contract n° 4000105495/12/NL/SFe dated 27/2/2012.

3 Applicable and Reference Documents

3.1 Applicable Documents

AD-1. Hirex proposal « Test Methods, Requirements, and Guidelines for Evaluation of Radiation Sensitivity of Analog to Digital Converters (ADC), Digital to Analog Converters (DAC) and Vertical Power MOSFETs» HRX/PRO/3624 Issue 01 /2011/10/12

AD-2. ADS1278, Texas Instruments datasheet, Octal, Simultaneous Sampling, 24-Bit Analog-to-Digital Converter –SBAS367F –JUNE 2007–REVISED FEBRUARY 2011

3.2 Reference Documents

RD-1. Single Event Effects Test method and Guidelines ESA/SCC basic specification No 25100

4 DEVICE INFORMATION

4.1 Device description

ADS1278 is an Octal, Simultaneous Sampling, 24-Bit Analog-to-Digital Converter.

Functional
diagram

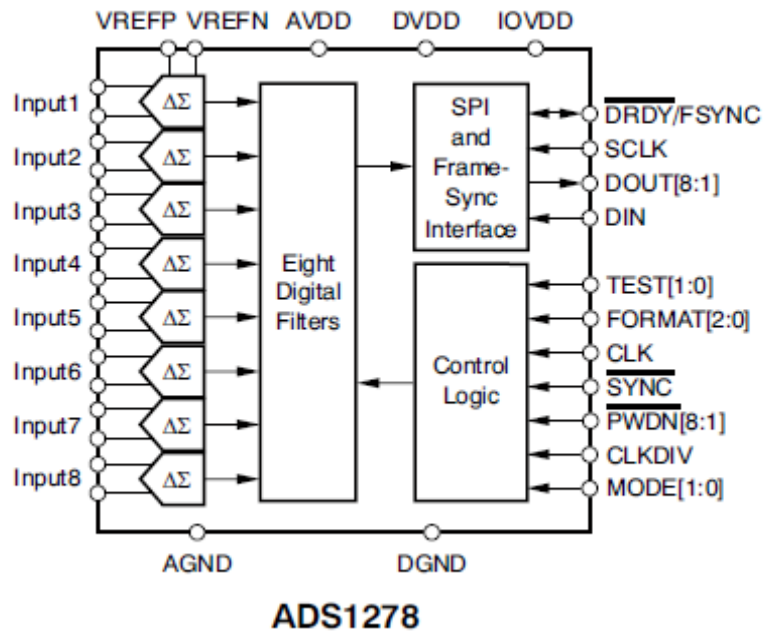

<u>Part type:</u>	ADS1278
<u>Manufacturer:</u>	Texas Instruments
<u>Manufacturer part number:</u>	ADS1278IPAPTG4
<u>Manufacturer lot number:</u>	-
<u>Datecode:</u>	-
<u>Package:</u>	HTQFP-64
<u>Top marking:</u>	ogo 17CJYTT G4 ADS1278, logo 09C2Z8T G4 ADS1278
<u>Die dimensions:</u>	4959μ x 6008μ

4.2 Sample preparation

Samples are opened by chemical etching.

4.3 Sample identification

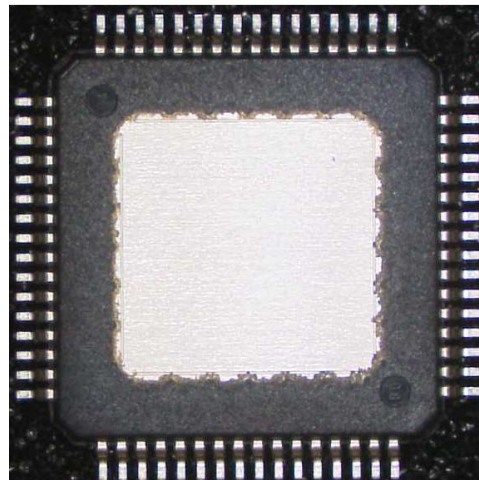

Photo 1 & 2 – Device top & bottom view



Photo 3 – External marking

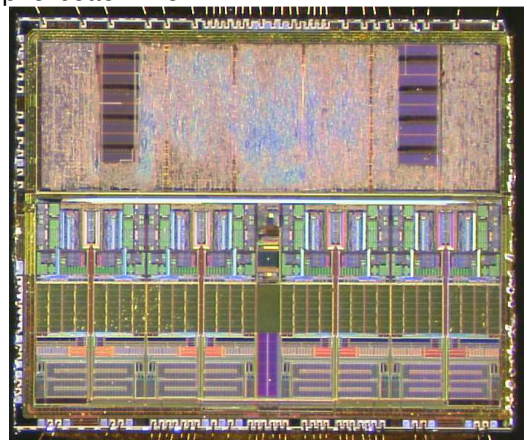

Photo 4 – Die full view

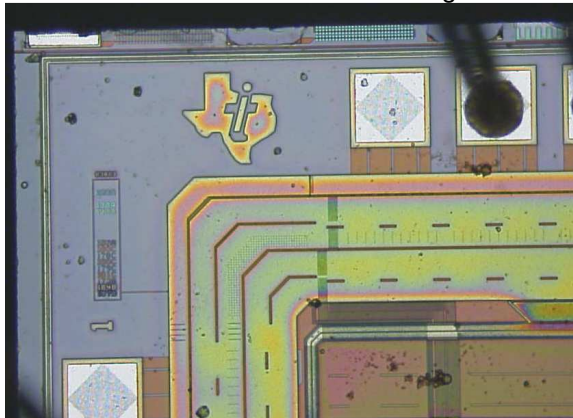

Photo 5 – Die marking 1

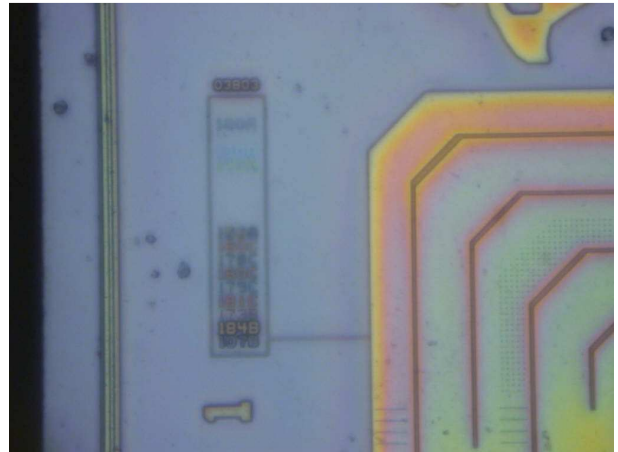

Photo 6 – Die marking 2

Figure 1: ADS1278 device identification

5 RADEF Facility

Test at the cyclotron accelerator was performed at University of Jyvaskyla (JYFL) (Finland) under HIREX Engineering responsibility.

The facility includes a special beam line dedicated to irradiation studies of semiconductor components and devices. It consists of a vacuum chamber including component movement apparatus and the necessary diagnostic equipment required for the beam quality and intensity analysis.

The cyclotron is a versatile, sector-focused accelerator of beams from hydrogen to xenon equipped with three external ion sources: two electron cyclotron resonance (ECR) ion sources designed for high-charge-state heavy ions, and a multicusp ion source for intense beams of protons. The ECR's are especially valuable in the study of single event effects (SEE) in semiconductor devices. For heavy ions, the maximum energy attainable can be determined using the formula,

$$130 Q^2/M,$$

where Q is the ion charge state and M is the mass in Atomic Mass Units.

Test chamber

Irradiation of components is performed in a vacuum chamber with an inside diameter of 75 cm and a height of 81 cm.

The vacuum in the chamber is achieved after 15 minutes of pumping, and the inflation takes only a few minutes. The position of the components installed in the linear movement apparatus inside the chamber can be adjusted in the X, Y and Z directions. The possibility of rotation around the Y-axis is provided by a round table. The free movement area reserved for the components is 25 cm x 25 cm, which allows one to perform several consecutive irradiations for several different components without breaking the vacuum.

The assembly is equipped with a standard mounting fixture. The adapters required to accommodate the special board configurations and the vacuum feed-throughs can also be made in the laboratory's workshops. The chamber has an entrance door, which allows rapid changing of the circuit board or individual components.

A CCD camera with a magnifying telescope is located at the other end of the beam line to determine accurate positioning of the components. The coordinates are stored in the computer's memory allowing fast positioning of various targets during the test.

Beam quality control

For measuring beam uniformity at low intensity, a CsI(Tl) scintillator with a PIN-type photodiode readout is fixed in the mounting fixture. The uniformity is measured automatically before component irradiation and the results can be plotted immediately for more detailed analysis.

A set of four collimated PIN-CsI(Tl) detectors is located in front of the beam entrance. The detectors are operated with step motors and are located at 90 degrees with respect to each other. During the irradiation and uniformity scan they are set to the outer edge of the beam in order to monitor the stability of the homogeneity and flux.

Two beam wobblers and/or a 0.5 microns diffusion Gold foil can be used to achieve good beam homogeneity. The foil is placed 3 m in front of the chamber. The wobbler-coils vibrate the beam horizontally and vertically, the proper sweeping area being attained with the adjustable coil-currents.

Dosimetry

The flux and intensity dosimeter system contains a Faraday cup, several collimators, a scintillation counter and four PIN-CsI(Tl) detectors. Three collimators of different size and shape are placed 25 cm in front of the device under test. They can be used to limit the beam to the active area to be studied.

At low fluxes a plastic scintillator with a photomultiplier tube is used as an absolute particle counter. It is located behind the vacuum chamber and is used before the irradiation to normalize the count rates of the four PIN-CsI(Tl) detectors.

Ion	LET ^{SRIM} at surface [MeV.cm ² .mg ⁻¹]	Range [μm]	Beam energy [MeV]
¹⁵ N ⁺⁴	1.83	202	139
²⁰ Ne ⁶⁺	3.63	146	186
⁴⁰ Ar ¹²⁺	10.2	118	372
⁵⁶ Fe ¹⁵⁺	18.5	97	523

SRIM-2003.26

Table 1 – Ion beam setting

6 Test Set-up

Test system Figure 2 shows the principle of the Heavy Ion test system.

The test system is based on a Virtex4 FPGA (Xilinx). It runs at 50 MHz. The test board has 168 I/Os which can be configured using several I/O standards.

The test board includes the voltage/current monitoring and the latch-up management of the DUT power supplies up to 24 independent channels.

A SEL event is detected when the monitored power supply current exceeds the corresponding given threshold current within a few microseconds; it is then followed by a device under test power reset after a given off time.

The communication between the test chamber and the controlling computer is effectively done by a 100 Mbit/s Ethernet link which safely enables high speed data transfer.

Test board has been designed so that 2 samples can be eventually tested at the same time to heavy ions.

Two ADS1278 parts are mounted on the daughter board as shown in Figure 3. Schematic detail is shown in Figure 4.

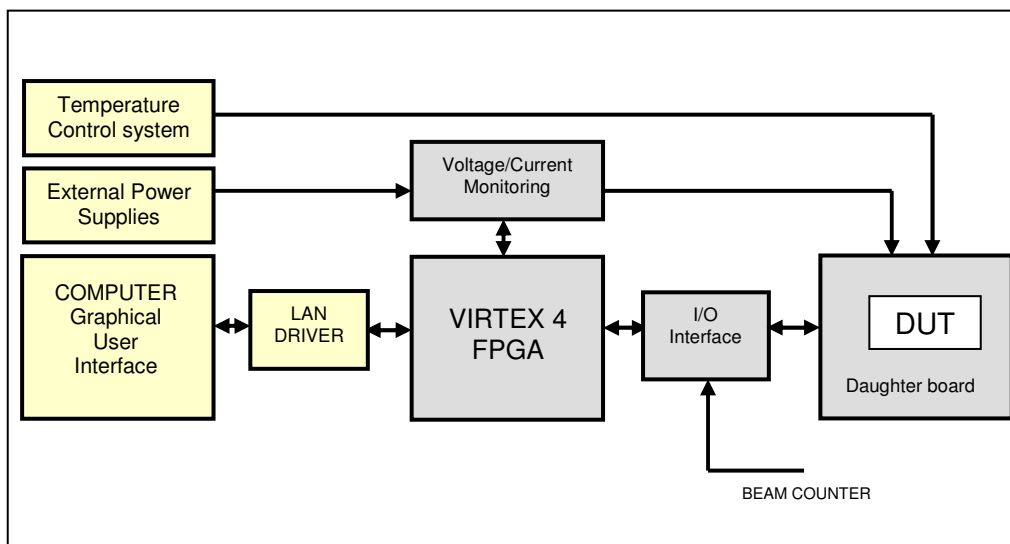

Figure 2: ADS1278, Heavy ion test set-up

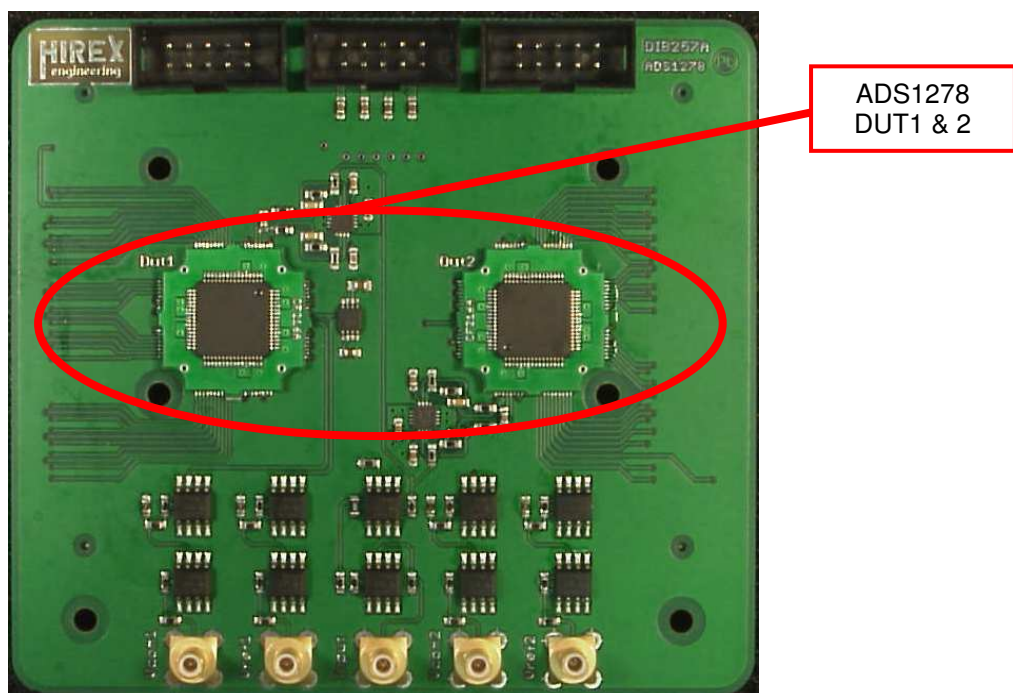

Figure 3: Daughter board (DIB257A) photo

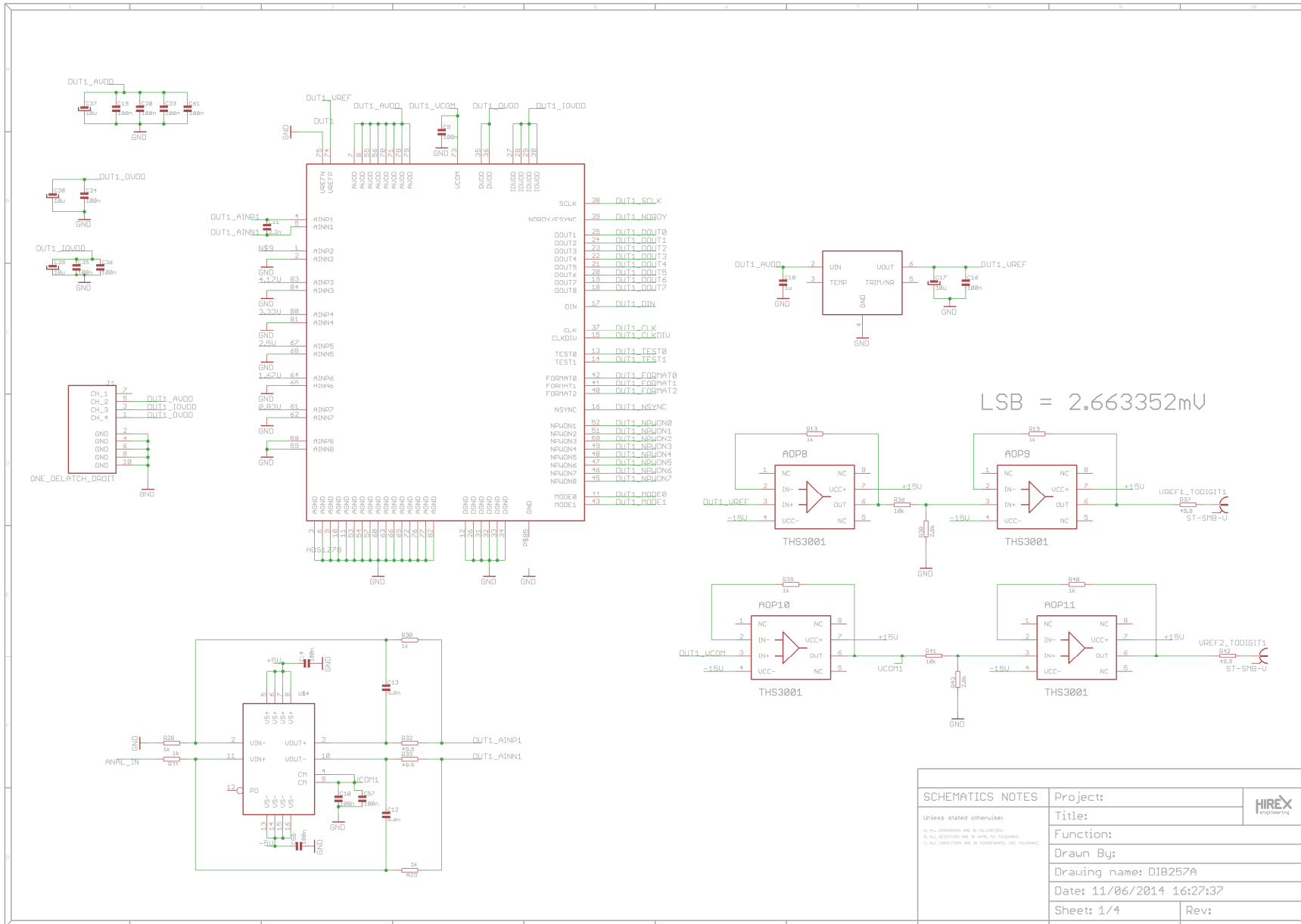

Figure 4: Daughter board schematic detail

SCHEMATICS NOTES		Project:	HIREX Engineering
Unless stated otherwise: A. ALL DIMENSIONS ARE IN MILLIMETERS B. ALL DECIMALS ARE TO BE AFTER THE DECIMAL C. ALL DIMENSIONS ARE TO BE HORIZONTAL, UNLESS TOLERANCE		Title:	
		Function:	
		Drawn By:	
		Drawing name: DIB257A	
		Date: 11/06/2014 16:27:37	
		Sheet: 1/4	Rev:

7 Test methods

For this AD converter testing, a sinewave signal is used at ADS1278 input. In addition to characterize the SEE behavior of the ADS1278, the objective of this test was also to compare the efficiency of different test methods based on different sets of sinewave input frequency and DUT sampling frequency. 3 test methods have then been implemented.

- beat frequency: With the input frequency f_{in} set very close to the sampling frequency, the output code of the ADC is a slow moving sine wave, changing at a rate of 1 LSB per clock cycle.
Input sine frequency f_{in} and sampling frequency f_s must repond to:

$$f_s - f_{in} = f_s / (2^N \cdot \pi) \text{ with } N=16$$

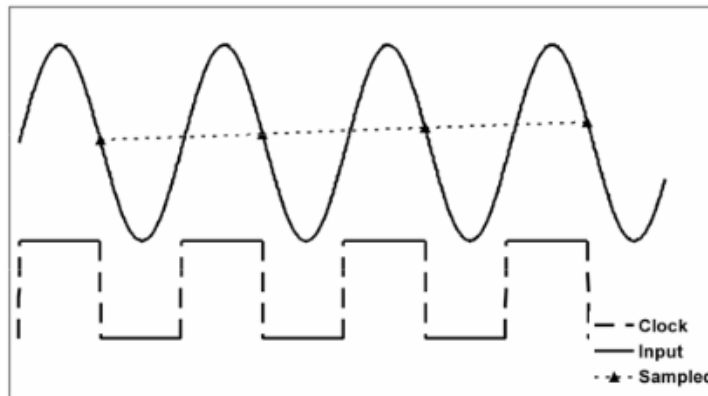

- 4points: DUT sampling frequency being fixed, the selected frequency of the sinewave input is such that only 4 points of the sinewave output are converted continuously.
Input sinewave frequency f_{in} and sampling frequency f_s must repond to:

$$f_{in} = f_s / 4$$

- Hirex method: DUT sampling frequency being fixed, input frequency f_{in} is set to a much lower value than f_s with f_s a multiple of f_{in} , leading to a significant number of points converted by sinewave input period.
Input sinewave frequency f_{in} and sampling frequency f_s must repond to:

$$f_{in} = f_s / m \text{ with } m \text{ integer}$$

In the present test, m was typically set to 1000.

8 Error detection and recording

For beat frequency, detection when the output shifts from the expected value is done by comparing with the previous clock conversion as it should differ only by 1 LSB and trig the data recording.

For 4 points method, this is achieved by comparing the output with the 4 clock times before output (or a multiple of 4).

For Hirex method, as for 4 points, this is achieved by comparing the output with the m clock times before output (or a multiple of m).

2048 conversions values before the detection trig and 2048 after are recorded wich allows for checking the occurrence of successive conversions in error if any.

8.1 Wave generation hardware

A specific board has been designed to produce a clock signal of frequency f_s in phase with a sine signal at the desired input frequency f_{in} , so that the three test methods can be implemented easily. Wave generation board principle is shown in Figure 5.

A single oscillator is used to produce the system's clock. This clock feeds the FPGA's Direct Digital Synthesis (DDS) block on one hand, and the external Digital to Analog Converter (DAC).

The DDS combined to the Signal processing block can produce square and/or sinus waveforms independantly with an accuracy inferior to the millihertz for each signal frequency.

We can also set the amplitude and the offset of these output signals before the analogic conversion. The waveforms are then converted via the DAC, amplified and symetrised if needed before entering the DUT.

The major benefit of this system is to generate two different waveforms from one single system clock. Then we can create two signals at the exact same frequency with no chance to see any unwanted phase shift. Moreover the system allows us to set the phase shift between these two signals very precisely if we want some phase shift. This can be usefull for the 4 points testing method : we can choose what are the 4 points on the sinewave we want to observe.

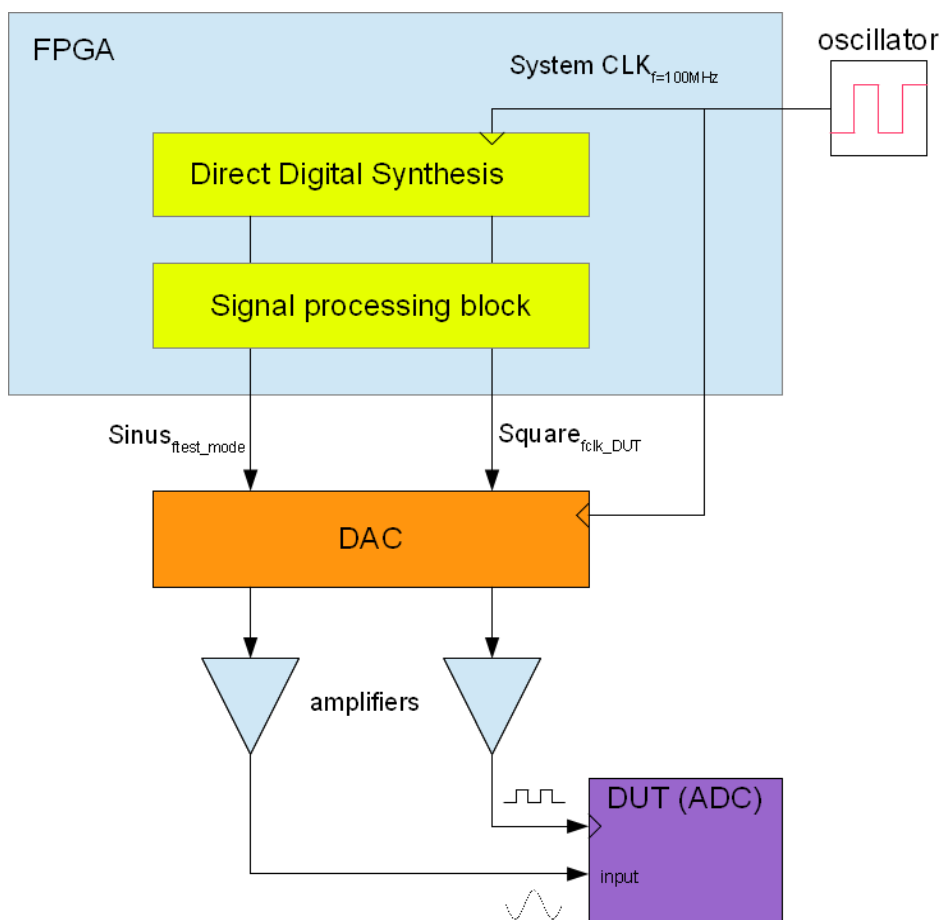

Figure 5 – Wave generation schematic

9 Bias conditions

- | | |
|--------------------|--------|
| • Analog | 5V |
| • Digital core | 1.8V |
| • I/O | 3.3V |
| • VREFN | Ground |
| • VREFP | 2.048V |
| • Room temperature | |

Figure 6 – Bias conditions

10 SEE Test Results

1 sample is tested at a time (DUT1 or DUT2) using bias conditions of Figure 6.

Device was configured in high speed operating mode.

A sine wave has been applied to Input 1 while different constant signals were applied to the other inputs (Input 2 to to input 8).

Run details and results are provided in Table 2. All runs were performed with normal incidence beam (no tilt).

Event cross sections have been calculated by taking into account the number of events with a detection threshold of 70LSBs. Table provides also the low and up limits computed with 95% confidence level and a 10% uncertainty on fluence.

10.1 SEL

First latchup has been detected during run002 with Argon and LET value of 10.2MeV/(mg/cm²) on AVDD. This SEL was destructive as the device did not convert anymore.

With Iron and LET value of 18.5MeV/(mg/cm²), 9 SELs were detected during run029 with a corresponding SEL cross-section of about 1.13 10⁻⁰⁴ cm². At the end of run029, device was not functional anymore.

Test campaign was then stopped.

10.2 SET

Input sine wave frequency for each test method is listed below with conversion frequency set to 145KHz.

24 bits ADS1278	Conversion frequency Hz	Sine wave input frequency Hz		
bits monitored #	f conv	4points	beat freq	hirex
16 MSBs	1.45E+05	36000	143999.997	722.656

Input analog sinewave amplitude was adjusted close to ADC fullscale. For the 16MSBs monitored, 1 LSB corresponds to 76μV.

SET event amplitude and duration definition used in this report is presented in Figure 7

Figure 8 shows the digital output waveforms captured with the 3 different test methods.

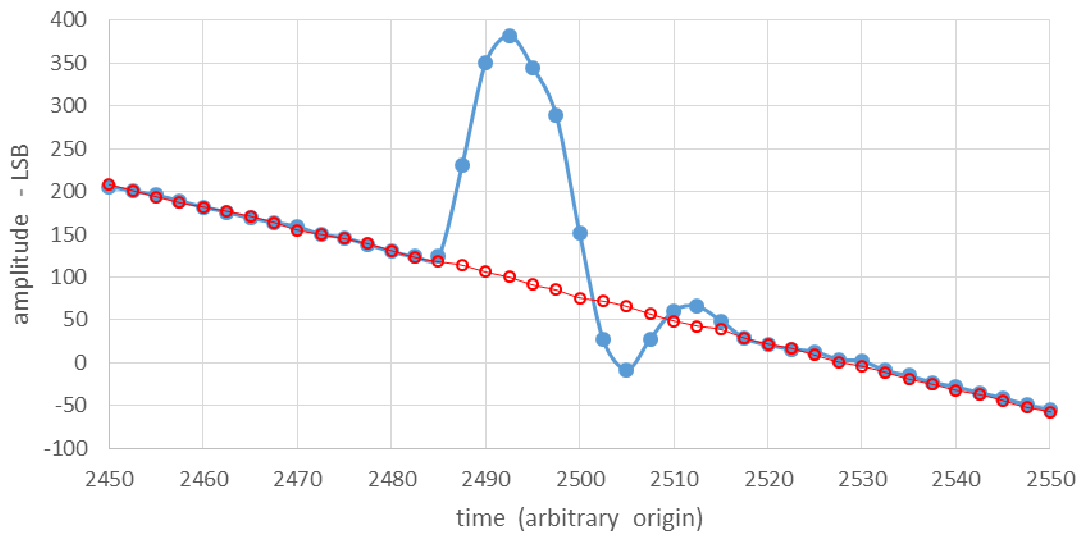

a)

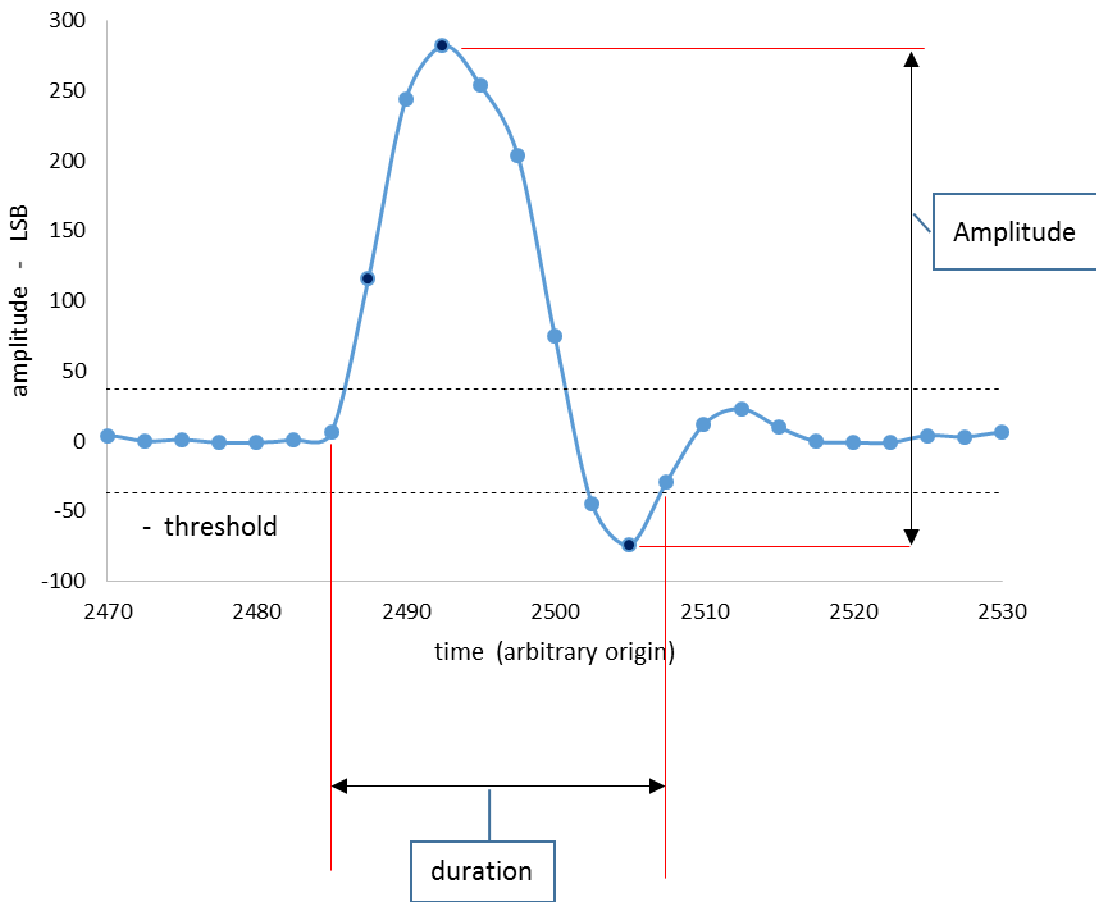

b)

Figure a) shows ADC output (blue dot) for an event trig together with ADC output 200 conversions before (red dot).

In figure b) the difference between the 2 curves of figure a) is plot. Event amplitude is defined as the maximum amplitude value minus the minimum value and event duration is the difference in time between the last point before the first conversion above threshold (dotted line) and the first point after the last conversion above threshold.

1 LSB corresponds to 76µV.

Figure 7 – SET amplitude and duration

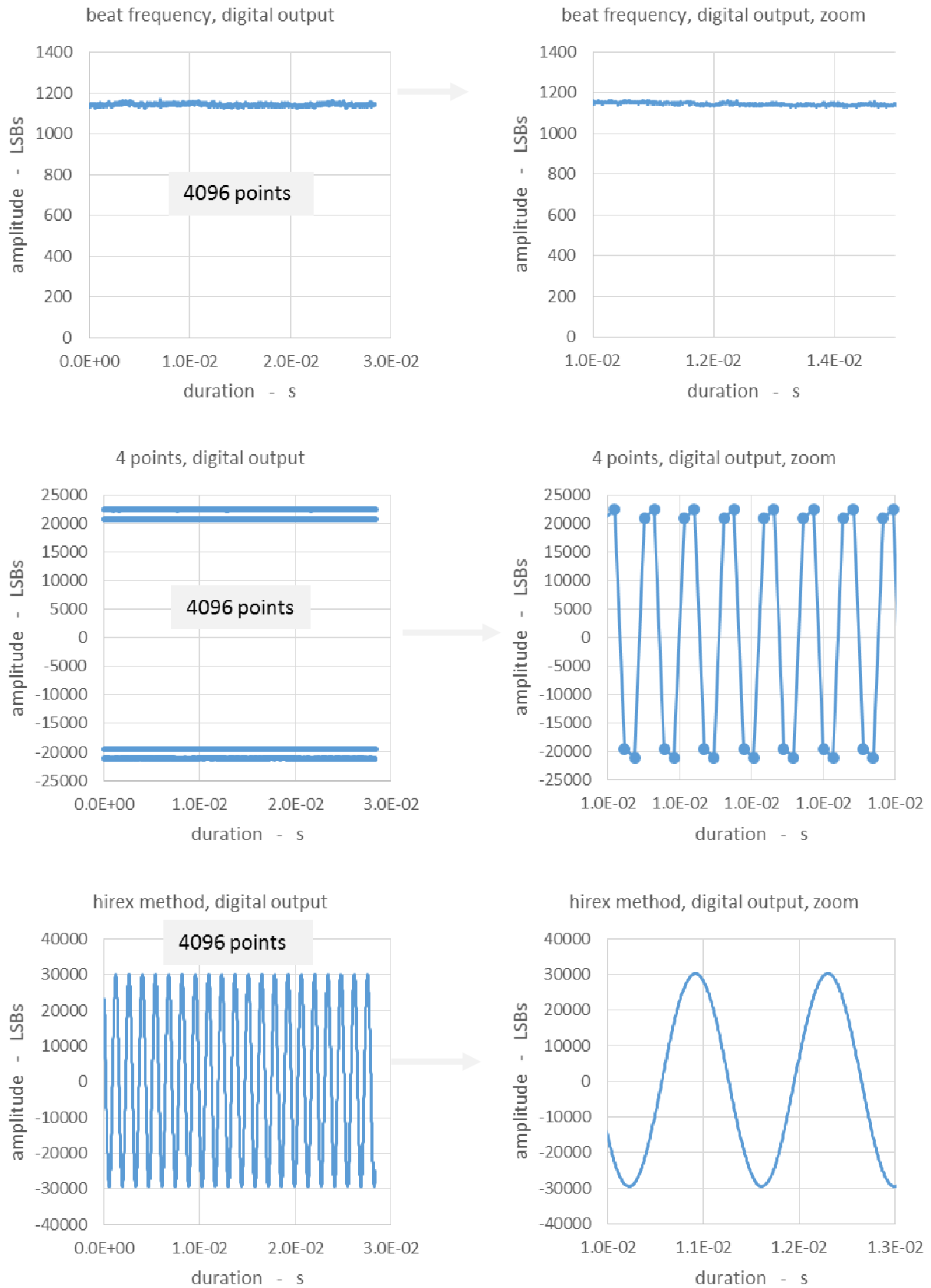

Figure 8 – Digital output waveforms captured with the 3 different methods

Facility	medium	hirex run #	Board_id	dut_part_id	test_mode	Ion	Eff. LET	eff. Fluence	sel	tester digitizer threshold (LSBs)	Nb events recorded above threshold	Nb events above 70LSBs	SEU Cross-section	error bar up	error bar down	delta up	delta down	SEL cross-section
radef	vacuum	9	1	2	4 points	Ne	3.63	1.03E+07		28	205	177	1.72E-05	2.04E-05	1.42E-05	3.2E-06	3.0E-06	
radef	vacuum	11	1	2	4 points	Ne	3.63	1.30E+07		28	232	186	1.43E-05	1.69E-05	1.19E-05	2.6E-06	2.4E-06	
radef	vacuum	22	2	1	4 points	N	1.83	2.00E+07		31	6	6	3.00E-07	6.54E-07	1.08E-07	3.5E-07	1.9E-07	
radef	vacuum	21	2	2	4 points	N	1.83	2.00E+07		31	1	1	5.00E-08	2.79E-07	1.01E-09	2.3E-07	4.9E-08	
radef	vacuum	5	1	2	Beat freq.	Ne	3.63	1.05E+07		30	159	134	1.28E-05	1.54E-05	1.03E-05	2.7E-06	2.4E-06	
radef	vacuum	13	1	2	Beat freq.	Ne	3.63	1.74E+07		30	295	250	1.44E-05	1.68E-05	1.21E-05	2.4E-06	2.2E-06	
radef	vacuum	24	2	1	Beat freq.	N	1.83	2.01E+07		20	4	4	1.99E-07	5.10E-07	5.29E-08	3.1E-07	1.5E-07	
radef	vacuum	26	2	2	Beat freq.	N	1.83	2.01E+07		25	7	7	3.48E-07	7.19E-07	1.37E-07	3.7E-07	2.1E-07	
radef	vacuum	29	2	2	Beat freq.	Fe	18.5	7.99E+04	9	35	25	25	3.13E-04	4.65E-04	1.98E-04	1.5E-04	1.1E-04	1.13E-04
radef	vacuum	2	1	1	Hirex	Ar	10.2	1.24E+06	1	1000	70	70	5.66E-05	7.26E-05	4.29E-05	1.6E-05	1.4E-05	8.09E-07
radef	vacuum	3	1	2	Hirex	Ne	3.63	2.00E+07		1000	160	160	8.00E-06	9.56E-06	6.56E-06	1.6E-06	1.4E-06	
radef	vacuum	15	1	2	Hirex	Ne	3.63	1.55E+07		50	253	221	1.43E-05	1.67E-05	1.19E-05	2.5E-06	2.3E-06	
radef	vacuum	16	2	1	Hirex	Ne	3.63	2.36E+07		70	333	333	1.41E-05	1.62E-05	1.21E-05	2.1E-06	2.0E-06	
radef	vacuum	18	2	1	Hirex	N	1.83	2.00E+07		70	10	10	5.00E-07	9.22E-07	2.35E-07	4.2E-07	2.6E-07	
radef	vacuum	19	2	2	Hirex	N	1.83	2.00E+07		70	16	16	8.00E-07	1.31E-06	4.48E-07	5.1E-07	3.5E-07	

radef	vacuum	all runs cumulated					1.83	1.20E+08			44	3.66E-07	4.97E-07	2.59E-07	1.3E-07	1.1E-07	
radef	vacuum	all runs cumulated					3.63	1.10E+08			1461	1.32E-05	1.47E-05	1.18E-05	1.5E-06	1.5E-06	
radef	vacuum	all runs cumulated					10.2	1.24E+06	1		70	5.66E-05	7.26E-05	4.29E-05	1.6E-05	1.4E-05	8.09E-07
radef	vacuum	all runs cumulated					18.5	7.99E+04	9		25	3.13E-04	4.65E-04	1.98E-04	1.5E-04	1.1E-04	1.13E-04

In the column "above 70LSBs", a red mark means that the threshold was higher than 70LSBs and was the one in the "above threshold" column.

Table 2 – RADEF, October2014 (W44), ADS1278, run table

Detection threshold is set between 20 and 70 LSbs (1.52mV to 5.32mV) with 1LSB corresponding to 76µV.

In Table 2 for each run, the detection threshold level in LSbs is noted (column “threshold (LSBs)”) together with the number of events detected (column ‘Nb events above threshold”). As this threshold is not identical for all runs and to ease comparison, we have extracted the number of events which would have been triggered with a threshold of 70LSBs: see column “NB events above 70LSBs”.

Corresponding SET event cross-section / device is presented in Figure 10.

In addition, the table provides the error bar values computed as indicated in §1.

In addition for each LET value, runs have been cumulated and the resulting SET cross-section plot is shown in Figure 10.

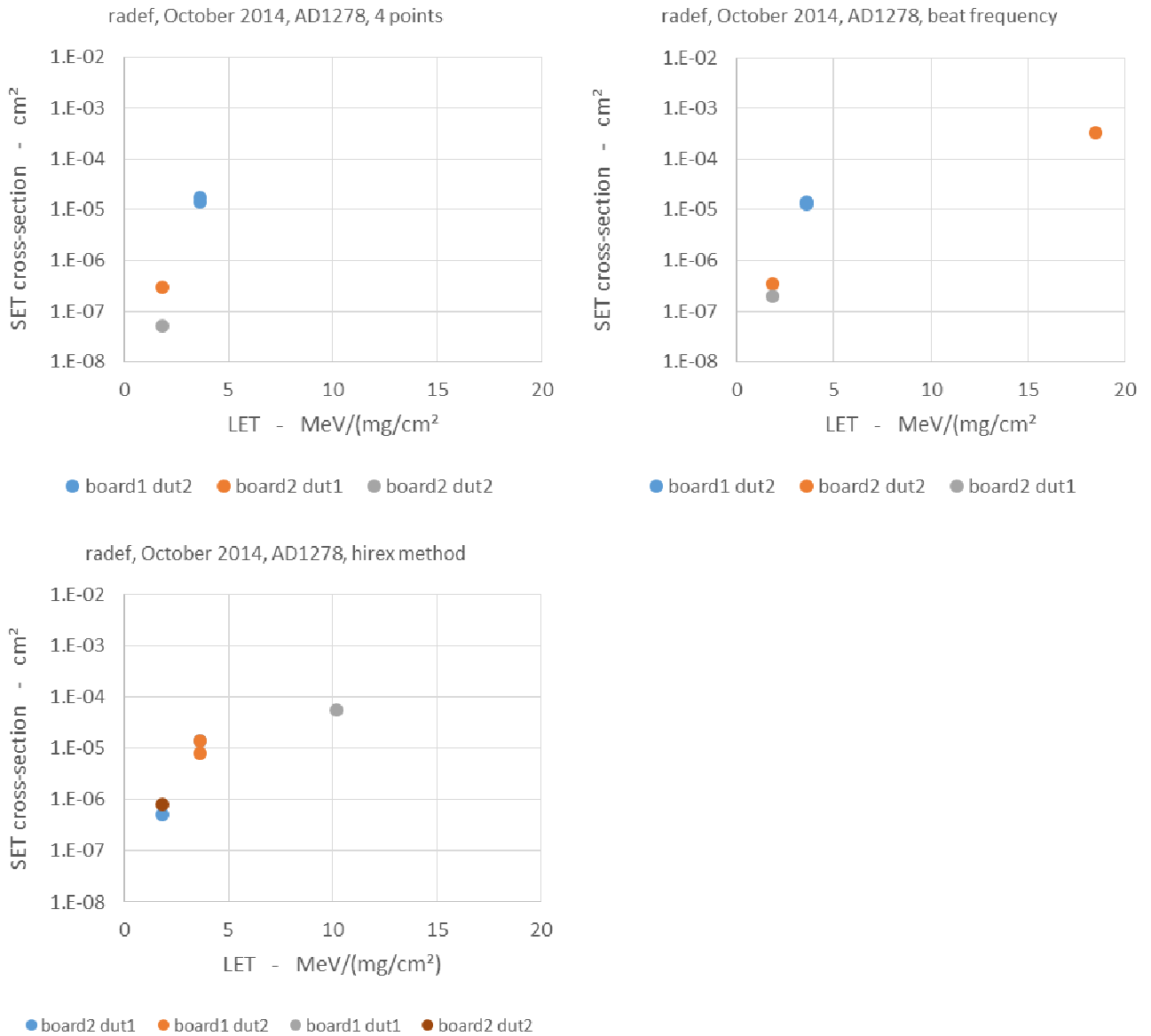

Figure 9 – radef, October 2014, SET event cross-section for the three test methods

radef, October 2014, AD1278, SET cross-section (all runs cumulated)

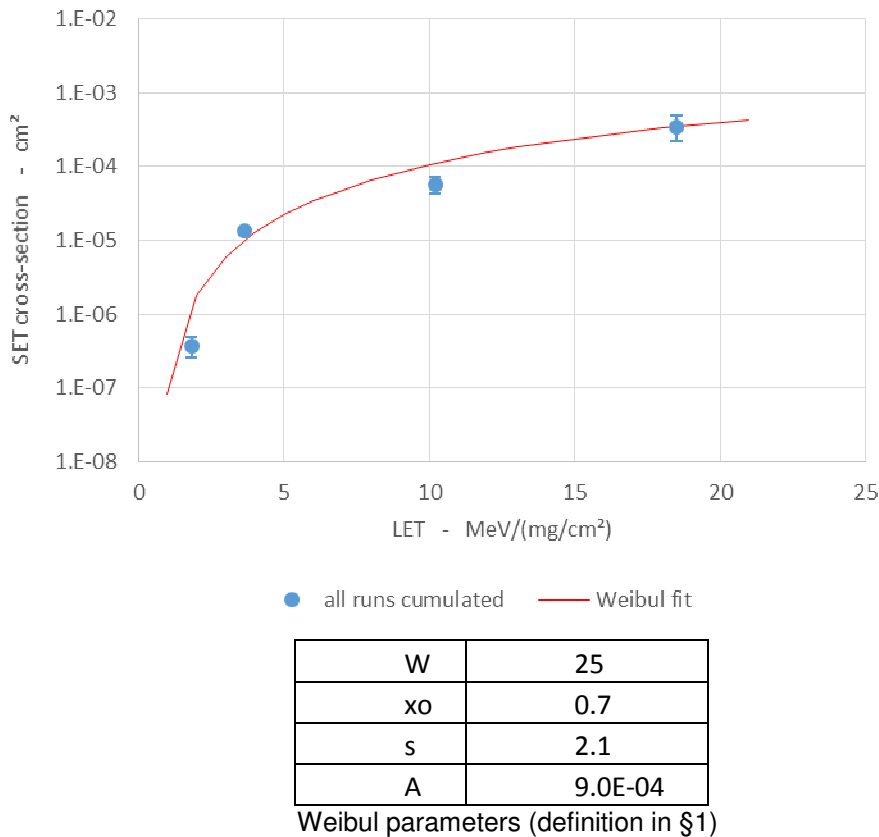

Figure 10 – SET event cross-section with all runs cumulated per LET value

Event distribution are shown for each method in Figure 11 and Figure 12

Three different populations can be identified.

- Event with only one conversion in error (duration = 13.9 μ s). Events examples are shown in Figure 13 where it can be observed that the three methods can detect such events.
- Events with consecutive conversions in error. Such events are shown in Figure 14 and in Figure 15
Again it can be observed that the 3 methods can detect such events.
- Events with very long duration. Only very few events (4 in total) have been observed with hirex method and beat frequency method. These events are shown in Figure 16.
However testing at higher LET was not feasible as device was degraded with Iron and SEE characterisation was stopped.

From the above, we can state that each of the 3 methods can detect the different events populations and event cross-sections are similar with Neon and Nitrogen.

radef Oct 2014, AD1278, event amplitude versus event duration

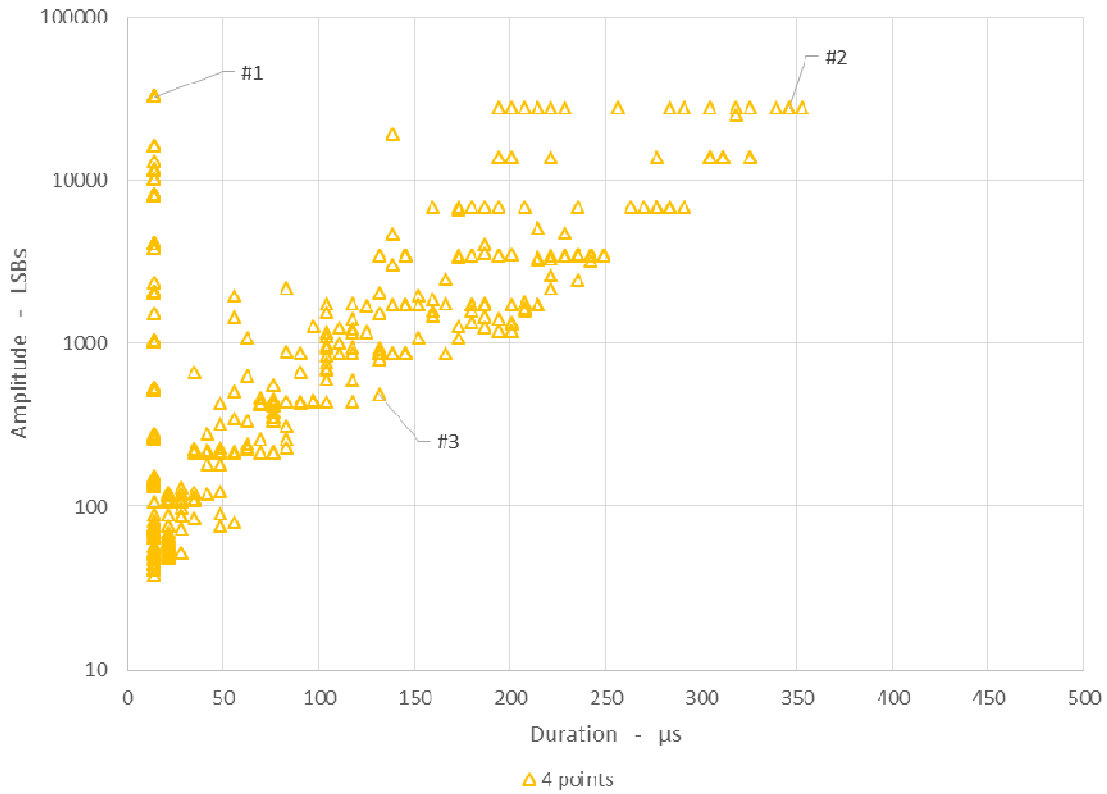

a)

radef Oct 2014, AD1278, event amplitude versus event duration

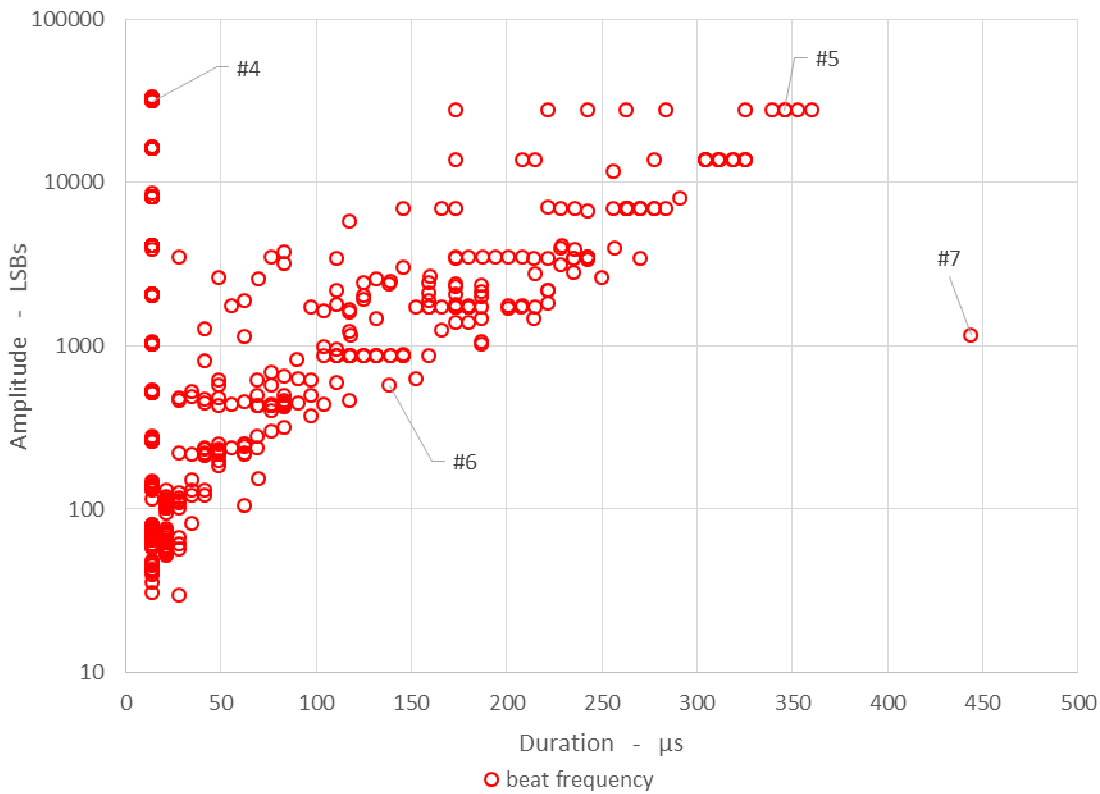

b)

#numbers in the plots refer to event waves shown in the following pages

Figure 11 – RADEF, October 2014, ADS1278 events distribution, 4 points and beat frequency

radef Oct 2014, AD1278, event amplitude versus event duration

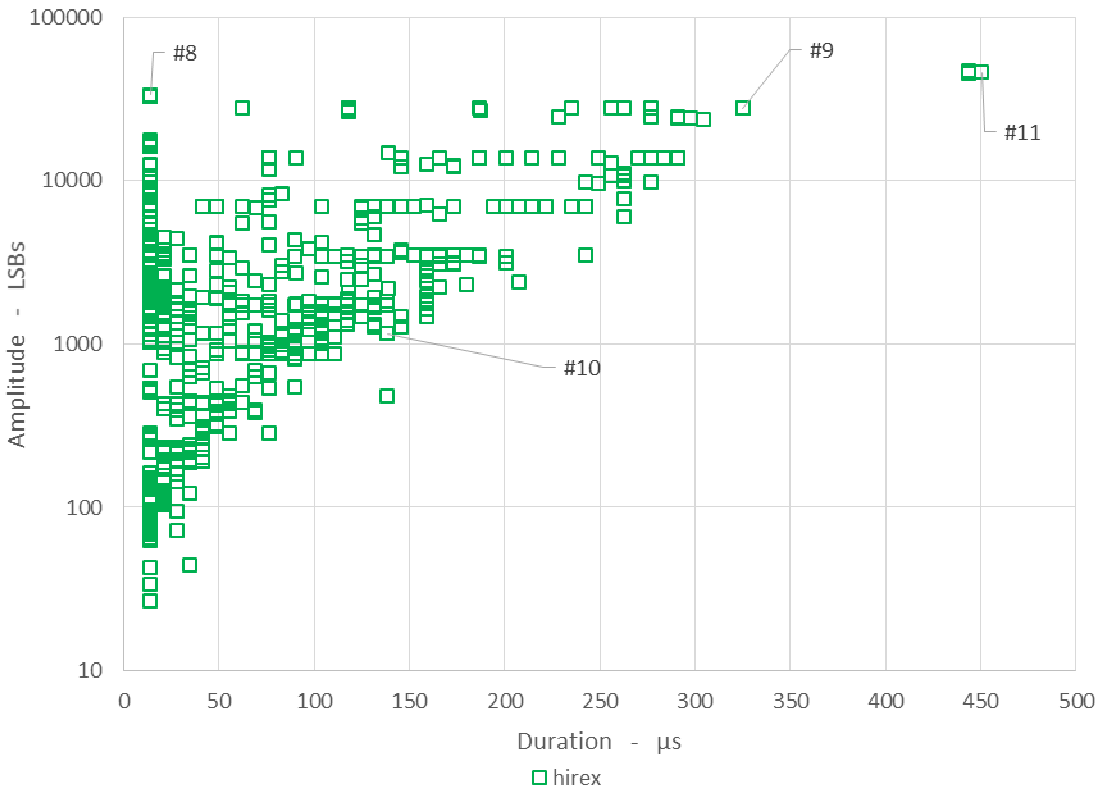

c)

radef Oct 2014, AD1278, event amplitude versus event duration

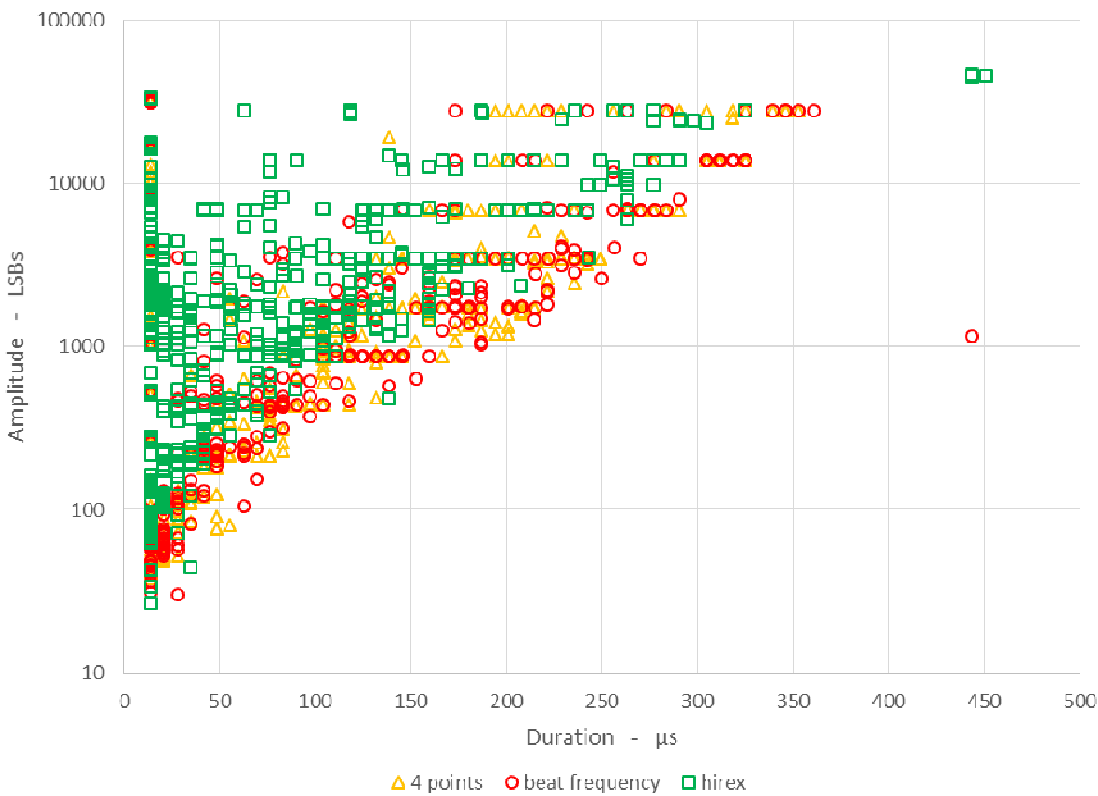

d)

#numbers in the plots refer to event waves shown in the following pages

Figure 12 – RADEF, October 2014, ADS1278 events distribution, hirex method and all methods

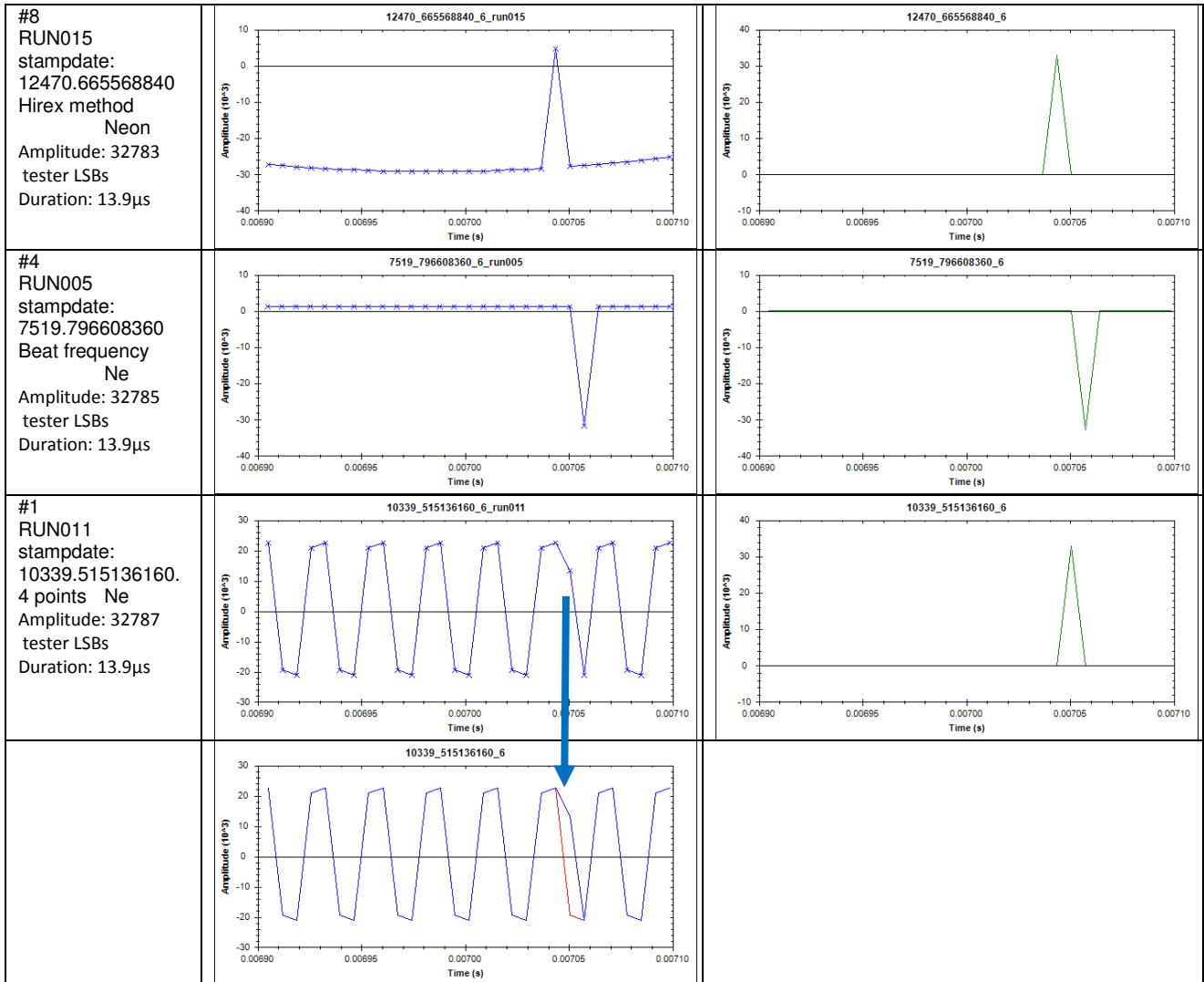

Figure 13 – RADEF, October 2074, SET events examples, high amplitude small duration

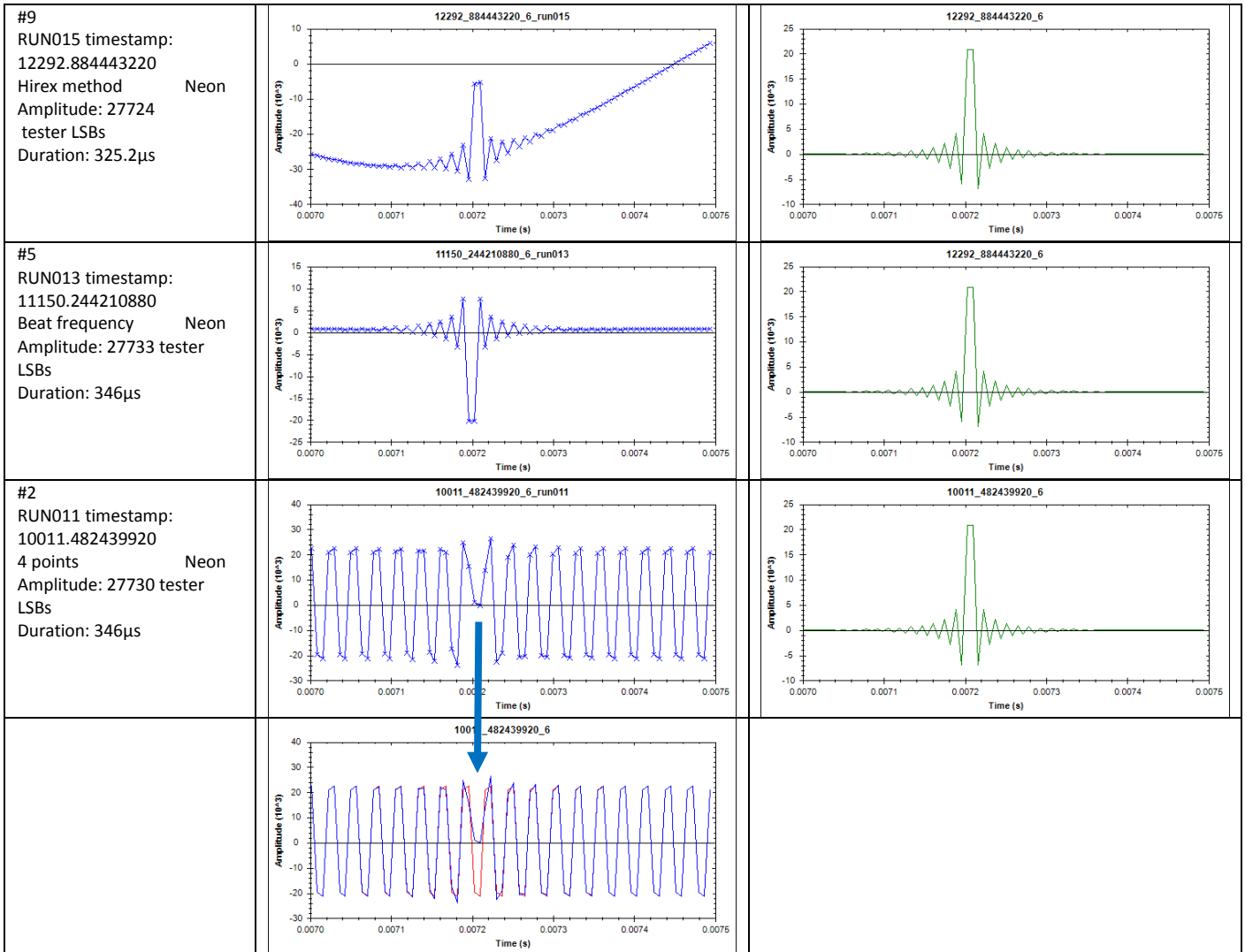
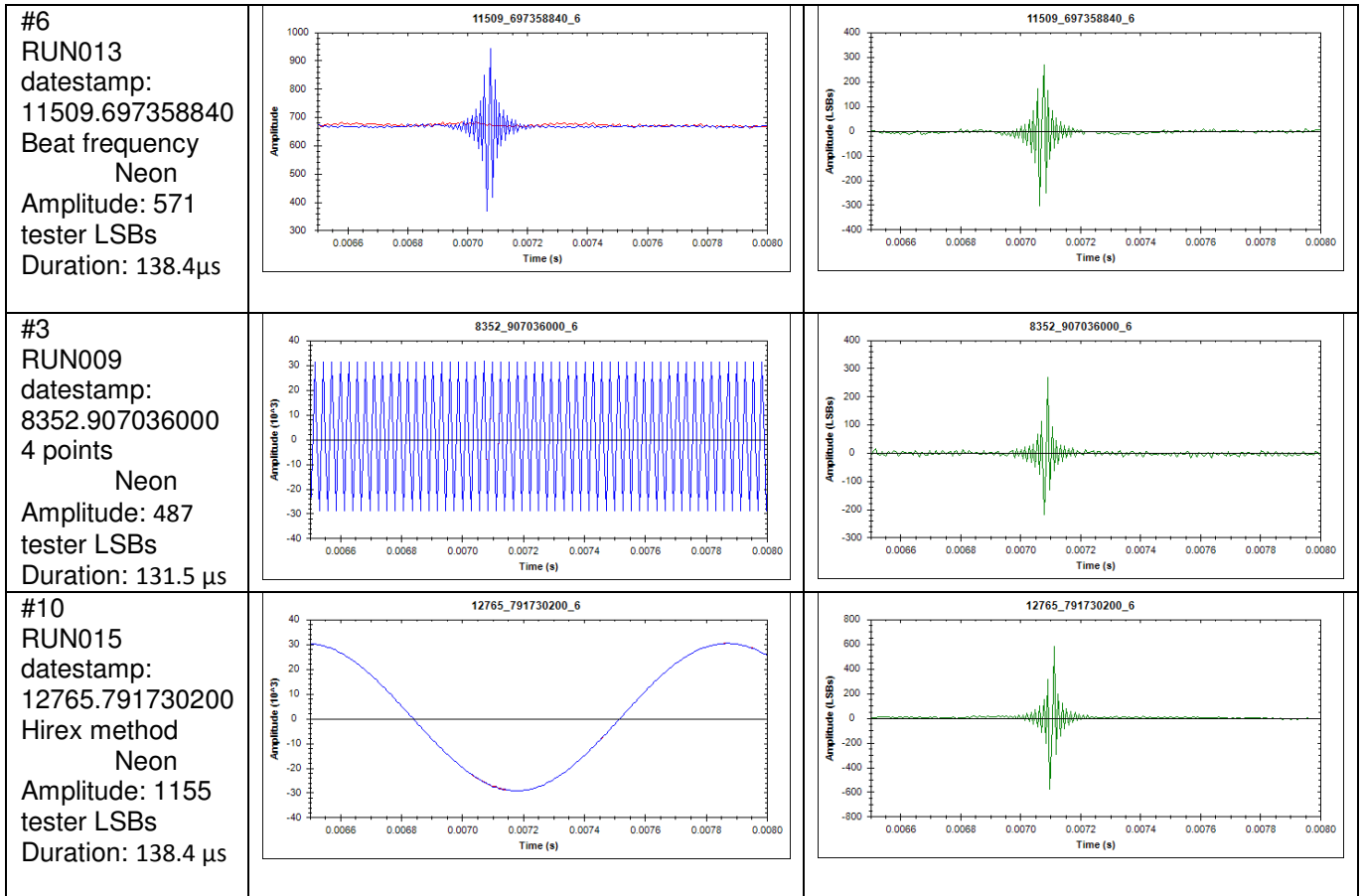
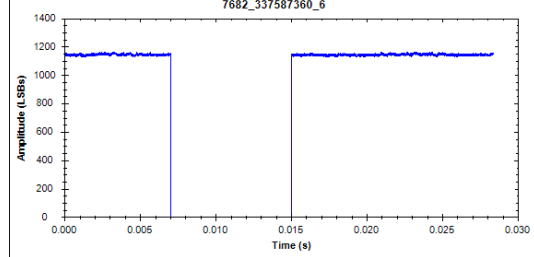
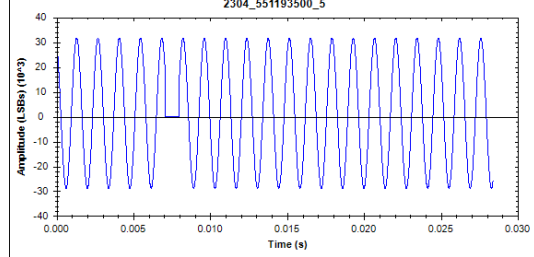
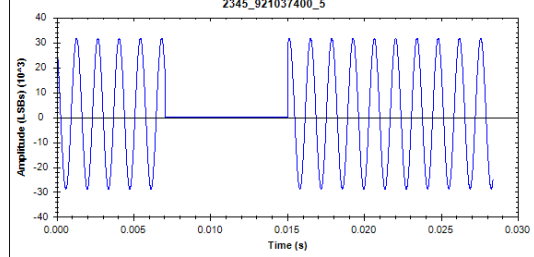
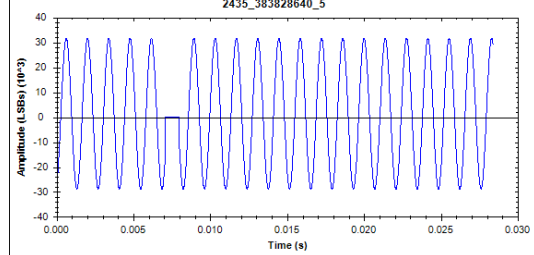

Figure 14 – RADEF, October 2014, SET events examples, high amplitude and high duration



Events with 4 points and Hirex methods can only be seen when delta wave between output with and without event is plotted. With beat frequency however, it is easier to see the event directly from the output waveform.

Figure 15 – RADEF, October 2014, SET events examples, medium amplitude and duration

<p>#7 RUN005 datestamp; 7682.337587360 Beat frequency, Neon Event duration: 8ms</p>	
<p>#12 RUN002 datestamp: 2304.551193500 Hirex method Argon Event duration: 0.9ms</p>	
<p>#11 RUN002 datestamp: 2345.921037400 Hirex method Argon Event duration: 8ms</p>	
<p>#13 RUN002 datestamp: 2435.383828640 Hirex method Argon Event duration: 0.9ms</p>	

Only 4 events with a very long duration were detected during the present set of runs. However one can note that SEE characterisation was stopped with Iron as device was degraded.

Figure 16 – RADEF, October 2014, SET events examples, very long duration