

PROTONS TEST REPORT



ESA study: "Survey of Critical Components for 150 kRad Power Systems"

ESTEC Contract N° 22831/09/NL/AF refers

<p>Part Type : LM124AJRQMLV</p> <p>Package : CERDIP-14</p> <p>Description : Low Power Quad Bipolar Operational Amplifier</p> <p>Manufacturer: National Semiconductors</p>

Alter Technology Group Spain Purchase Order N° ATGSP-TL-09-JC-CO-9 dated 11/27/2009

Alter Technology Group Spain Project Manager: David NUNEZ

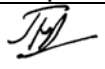
Hirex reference :	HRX/TID/0934	Issue : 01	Date :	June 6 th , 2011
Written by :	G. FAUCHON	Technician		
Approved by :	O.PERROTIN	Study Manager		
Authorized by:	J.F. PASCAL	Technical Manager		

Hirex Engineering	Protons Test Report		Ref.:	HRX/TID/0934
	LM124AJRQMLV	National Semiconductors	Issue:	01

PROTONS TEST REPORT
on
LM124AJRQMLV
Low Power Quad Bipolar Operational Amplifier
From National Semiconductors

TABLE OF CONTENTS

1 INTRODUCTION 4

2 APPLICABLE AND REFERENCE DOCUMENTS..... 4

 2.1 APPLICABLE DOCUMENTS..... 4

 2.2 REFERENCE DOCUMENTS 4

3 TEST SAMPLES 4

4 EXPERIMENTAL CONDITIONS 5

 4.1 RADIATION SOURCE DESCRIPTION 5

 4.2 BIAS DURING DOSE EXPOSURES AND MEASUREMENTS CONDITIONS 6

 4.2.1 Bias conditions 6

 4.2.2 Electrical Measurements 6

5 CONCLUSION 8

6 TEST RESULTS 9

List of figures:

Figure 1 : LIF layout and typical experimental set-up.....5

Figure 2: LIF Energy degraders.....5

Figure 3 : LM124AJRQMLV test program principle6

List of Tables:

Table 1 : Measured electrical parameters7

Table 2 : Summary of parameters failure levels8

Hirex Engineering	Protons Test Report		Ref.:	HRX/TID/0934
	LM124AJRQMLV	National Semiconductors	Issue:	01

1 Introduction

In the scope of the ESA study: "Survey of Critical Components for 150 kRad Power Systems", a protons test of the National Semiconductors LM124AJRQMLV, Low Power Quad Bipolar Operational Amplifier has been performed up to a total fluence of about $2E11$ p/cm², in response to Alter Technology Group Spain purchase order reference ATGSP-TL-09-JC-CO-9 that refers to ESTEC contract N° 22831/09/NL/AF.

Displacement damage effects were investigated using 60 MeV protons energy. Devices were irradiated at UCL in Louvain - Belgium.

The purpose of this test was to characterize degradation due to proton displacement damage so a further mission analysis could determine their suitability for flight use. This test was conducted on samples provided by Alter Technology Group Spain.

Test has been performed in accordance with Hirex Engineering Radiation Test Plan HRX/SPE/0238 issue 2 dated 09/13/2010.

A complete set of electrical measurements together with graphical representation of measured parameters with respect to Equivalent Fluence levels received is provided.

2 Applicable and Reference Documents

2.1 Applicable Documents

- Hirex Engineering Radiation Test Plan: HRX/SPE/0238 issue 2 dated 09/13/2010
- Alter Technology Group Proposal: ATGSP-OF-648/2009 Issue 1
- Minutes of Meeting: MM-SRP-ATG-0001 dated 29/10/2009
- Hirex specification: Total Ionizing dose test general procedure.
- SMD detail specification: 5962-99504

2.2 Reference Documents

- National Semiconductors datasheet dated June 2006

3 Test Samples

7 samples of the LM124AJRQMLV devices were tested (6 + 1 control sample).

Allocation of samples with respect to the protons incident energy is provided in the following table.

Serial Number	Samples Allocation
26	Control sample
27	Biased OFF
28	Biased OFF
29	Biased OFF
30	Biased OFF
32	Biased OFF
39	Biased OFF

Identification of the LM124AJRQMLV is given below:

Part Number: LM124AJRQMLV

Top Marking: logo H5A0517Z delta RM124AJRQMLV JM05911 82 WAFER14 serial

Bottom Marking: -

Date Code: -

Hirex Engineering	Protons Test Report		Ref.:	HRX/TID/0934
	LM124AJRQLV	National Semiconductors	Issue:	01

4 Experimental Conditions

4.1 Radiation Source Description

The protons exposures were performed at the UCL facility in Louvain-la-Neuve - Belgium. The Proton Irradiation facility (Light Ion irradiation Facility or LIF) was used for this experiment. The corresponding experimental set-up is shown in Figure 1.

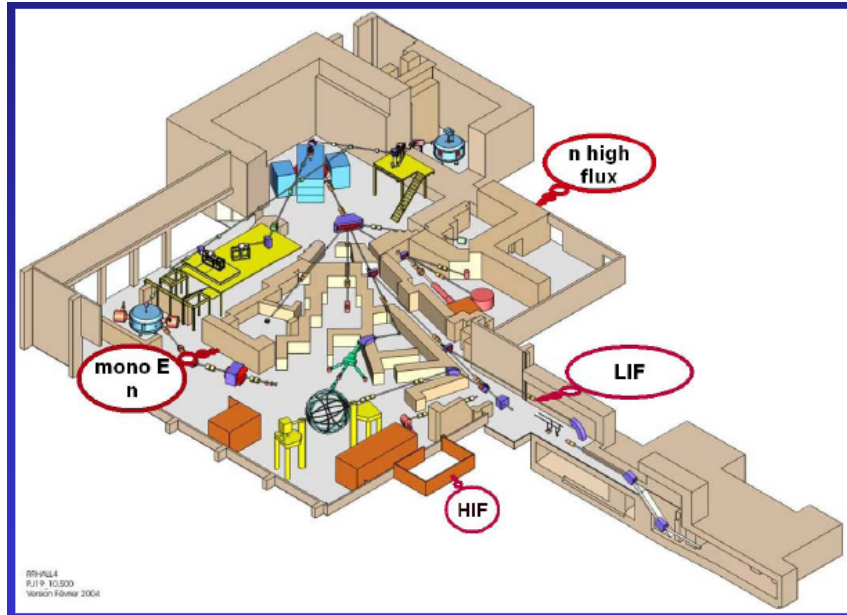

Figure 1 : LIF layout and typical experimental set-up

Light Ion irradiation Facility is characterized by the following beam parameters:

- Initial Proton Energies: 65 MeV;
- Energy Range: 9.3 – 62 MeV using energy degraders (See figure 2)
- Beam Flux at 62 MeV is between 10^7 p/cm²/sec to 5×10^8 p/cm²/sec
- Irradiation Area: 8 cm diameter maximum

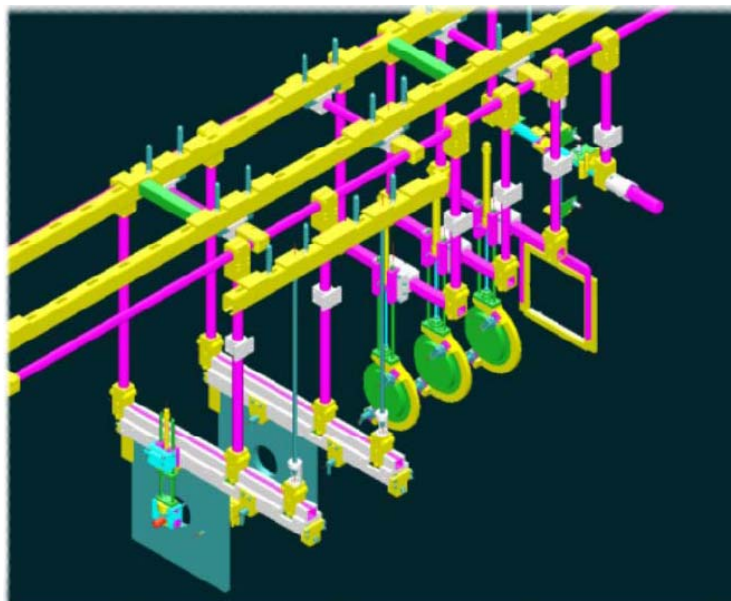

Figure 2: LIF Energy degraders

Hirex Engineering	Protons Test Report		Ref.:	HRX/TID/0934
	LM124AJRQMLV	National Semiconductors	Issue:	01

The irradiation conditions used for this test are provided in the following tables:

Fluence Steps	Total Fluence	Flux	Equivalent Total Dose	T
p/cm ² @60MeV	p/cm ² @60MeV	p/cm ² /s	Rad (Si)	°C
0	0		0	
2E+11	2E+11	5.00E+08	27.5E+3	25

4.2 Bias during Dose Exposures and Measurements conditions

4.2.1 Bias conditions

During exposures all samples were biased OFF with all pins connected to ground.

4.2.2 Electrical Measurements

Electrical parameters test program principle for LM124AJRQMLV is provided in Figure 3.

A HP4142 DC tester was used to perform required measurements.

A dedicated test fixture and a test board were designed to ensure proper measurement conditions.

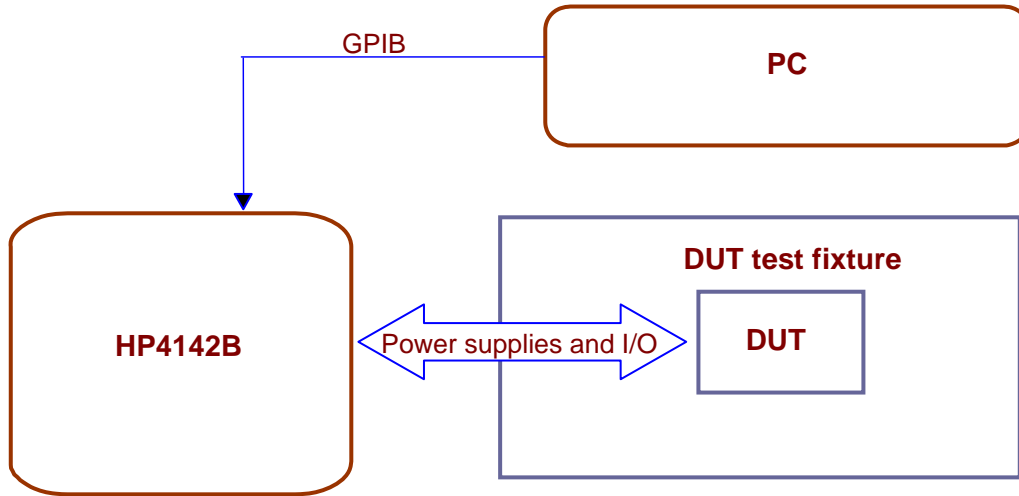

Figure 3 : LM124AJRQMLV test program principle

Hirex Engineering	Protons Test Report		Ref.:	HRX/TID/0934
	LM124AJRQMLV	National Semiconductors	Issue:	01

Electrical parameters test conditions and limits used for performing this test are given in Table 1.

Parameter	Description	Conditions	Spec		Unit
			Min	Max	
VIO1	Input Offset Voltage	+VCC=30V, -VCC=GND, VCM=-15V	-2	2	mV
VIO2		+VCC=2V, -VCC=-28V, VCM=13V	-2	2	mV
VIO3		+VCC=5V, -VCC=GND, VCM=-1.4V	-2	2	mV
VIO4		+VCC=2.5V, -VCC=-2.5V, VCM=-1.1V	-2	2	mV
IIO1	Input Offset Current	+VCC=30V, -VCC=GND, VCM=-15V	-10	10	nA
IIO2		+VCC=2V, -VCC=-28V, VCM=13V	-10	10	nA
IIO3		+VCC=5V, -VCC=GND, VCM=-1.4V	-10	10	nA
IIO4		+VCC=2.5V, -VCC=-2.5V, VCM=-1.1V	-10	10	nA
IIB+1	Input Bias Current	+VCC=30V, -VCC=GND, VCM=-15V	-50	0.1	nA
IIB+2		+VCC=2V, -VCC=-28V, VCM=13V	-50	0.1	nA
IIB+3		+VCC=5V, -VCC=GND, VCM=-1.4V	-50	0.1	nA
IIB+4		+VCC=2.5V, -VCC=-2.5V, VCM=-1.1V	-50	0.1	nA
IIB-1	Input Bias Current	+VCC=30V, -VCC=GND, VCM=-15V	-50	0.1	nA
IIB-2		+VCC=2V, -VCC=-28V, VCM=13V	-50	0.1	nA
IIB-3		+VCC=5V, -VCC=GND, VCM=-1.4V	-50	0.1	nA
IIB-4		+VCC=2.5V, -VCC=-2.5V, VCM=-1.1V	-50	0.1	nA
PSRR	Power Supply Rejection Ratio	-VCC=GND, VCM=-1.4V, 5V<+VCC<30V	-100	100	μV/V
CMRR	Common Mode Rejection Ratio	+VCC=30V, -VCC=GND, VCM=-15V to +VCC=2V, -VCC=-28V, VCM=13V	76		dB
ICC	Power Supply Current	+VCC=30V, -VCC=GND	-	3	mA
AVS1_1	Voltage Gain	+VCC=30V, -VCC=GND, 1V<Vout<26V, RL=10K	50	-	V/mV
AVS1_2		+VCC=30V, -VCC=GND, 5V<Vout<20V, RL=2K	50	-	V/mV
AVS2_1	Voltage Gain	+VCC=5V, -VCC=GND, 1V<Vout<2.5V, RL=10K	10	-	V/mV
AVS2_2		+VCC=5V, -VCC=GND, 1V<Vout<2.5V, RL=2K	10	-	V/mV
VOL1	Logical "0" output voltage	+VCC=30V, -VCC=GND, RL=10 kΩ	-	35	mV
VOL2		+VCC=30V, -VCC=GND, IOL=5mA	-	1.5	V
VOL3		+VCC=4.5V, -VCC=GND, IOL=2μA	-	0.4	V
VOH1	Logical "1" output voltage	+VCC=30 V, -VCC=GND, IOH=-10mA	27	-	V
VOH2		+VCC=4.5V, -VCC=GND, IOH=-10mA	2.4	-	V
VOP1	Maximum Output Voltage Swing	+VCC=30V, -VCC=GND, Vout=30V, RL=10K	27	-	V
VOP2		+VCC=30V, -VCC=GND, Vout=30V, RL=2K	26	-	V

Table 1 : Measured electrical parameters

Hirex Engineering	Protons Test Report		Ref.:	HRX/TID/0934
	LM124AJRQMLV	National Semiconductors	Issue:	01

5 Conclusion

A proton displacement damage test was carried out by Hirex Engineering under Alter Technology Group Spain contract on the National Semiconductors LM124AJRQMLV Low Power Quad Bipolar Operational Amplifier in CERDIP-14 package.

Each device was exposed at room temperature to a protons flux of 60 MeV incident energy up to a total fluence of $2E+11p/cm^2$.

A summary of failed parameters is provided in the following table. Parameters not listed remained within specification limits all along testing. Detail test results are presented in the following section.

Parameters	Failure Level between :
IIO1DUTD	0 & 2E+11 kRad(Si)
IIO2DUTD	0 & 2E+11 kRad(Si)
IIO3DUTA	0 & 2E+11 kRad(Si)
IIO3DUTD	0 & 2E+11 kRad(Si)
IIO4DUTA	0 & 2E+11 kRad(Si)
IIO4DUTD	0 & 2E+11 kRad(Si)
IIBP1DUTA	0 & 2E+11 kRad(Si)
IIBP1DUTB	0 & 2E+11 kRad(Si)
IIBP1DUTC	0 & 2E+11 kRad(Si)
IIBP1DUTD	0 & 2E+11 kRad(Si)
IIBP2DUTA	0 & 2E+11 kRad(Si)
IIBP2DUTB	0 & 2E+11 kRad(Si)
IIBP2DUTC	0 & 2E+11 kRad(Si)
IIBP2DUTD	0 & 2E+11 kRad(Si)
IIBP3DUTA	0 & 2E+11 kRad(Si)
IIBP3DUTB	0 & 2E+11 kRad(Si)
IIBP3DUTC	0 & 2E+11 kRad(Si)
IIBP3DUTD	0 & 2E+11 kRad(Si)
IIBP4DUTA	0 & 2E+11 kRad(Si)
IIBP4DUTB	0 & 2E+11 kRad(Si)

Parameters	Failure Level between :
IIBP4DUTC	0 & 2E+11 kRad(Si)
IIBP4DUTD	0 & 2E+11 kRad(Si)
IIBM1DUTA	0 & 2E+11 kRad(Si)
IIBM4DUTB	0 & 2E+11 kRad(Si)
IIBM4DUTC	0 & 2E+11 kRad(Si)
IIBM4DUTD	0 & 2E+11 kRad(Si)
IIBM2DUTB	0 & 2E+11 kRad(Si)
IIBM2DUTD	0 & 2E+11 kRad(Si)
IIBM3DUTA	0 & 2E+11 kRad(Si)
IIBM3DUTB	0 & 2E+11 kRad(Si)
IIBM3DUTC	0 & 2E+11 kRad(Si)
IIBM3DUTD	0 & 2E+11 kRad(Si)
IIBM4DUTA	0 & 2E+11 kRad(Si)
IIBM4DUTB	0 & 2E+11 kRad(Si)
IIBM4DUTC	0 & 2E+11 kRad(Si)
IIBM4DUTD	0 & 2E+11 kRad(Si)
AVS2_1DUTA	0 & 2E+11 kRad(Si)
AVS2_1DUTC	0 & 2E+11 kRad(Si)
AVS2_2DUTA	0 & 2E+11 kRad(Si)
AVS2_2DUTC	0 & 2E+11 kRad(Si)

Table 2 : Summary of parameters failure levels

Hirex Engineering	Protons Test Report		Ref.:	HRX/TID/0934
	LM124AJRQMLV	National Semiconductors	Issue:	01

Test Results

Test results including tables and graphics are provided in this section for each measured parameter.

Parameter measurements values are plotted versus Equivalent Fluence levels for 60 MeV incident energy protons. Fluences are expressed in protons/cm² in Silicon.

For each parameter, a drift calculation table is provided computing the drift between a given exposure step with respect to initial readings:

$$\Delta(\text{Parameter value}) = (\text{Parameter value}_{\text{POSTRAD}}) - (\text{Parameter value}_{\text{PRERAD}})$$

Test conditions : Protons

Parameter : Input Offset Voltage : VIO1DUTA

+VCC=30V. -VCC=GND. VCM=-15V

Unit : V

Spec Limit Min : -2.0E-03

Spec Limit Max : 2.0E-03

Spec limits are represented in bold lines on the graphic.

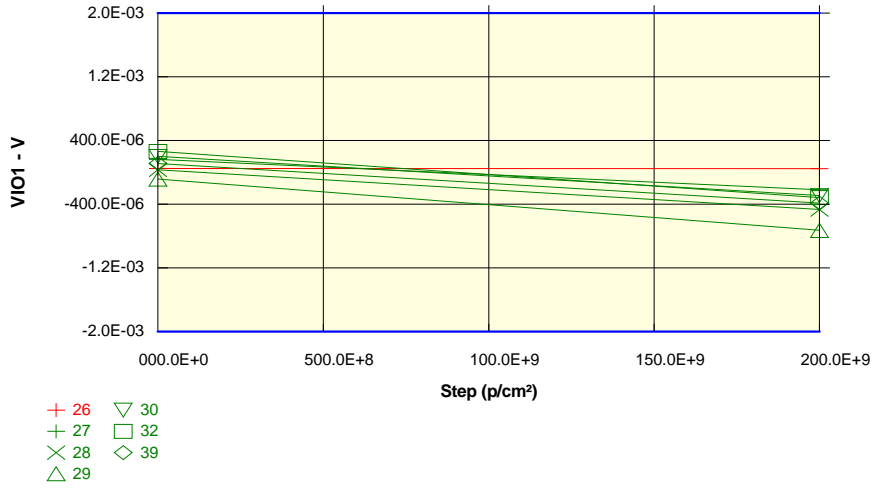

Measurements

VIO1DUTA	0 p/cm ²	2E+11 p/cm ²
26_REF	49.5E-06	45.8E-06
OFF samples		
27	163.8E-06	-218.8E-06
28	31.3E-06	-467.0E-06
29	-85.8E-06	-729.6E-06
30	199.4E-06	-292.6E-06
32	263.0E-06	-318.0E-06
39	109.9E-06	-385.9E-06
Statistics		
Min	-85.8E-06	-729.6E-06
Max	263.0E-06	-218.8E-06
Average	113.6E-06	-402.0E-06
Sigma	114.6E-06	165.5E-06

Drift Calculation

VIO1DUTA	0 p/cm ²	2E+11 p/cm ²
OFF samples		
27	-	-382.60E-06
28	-	-498.30E-06
29	-	-643.74E-06
30	-	-491.95E-06
32	-	-581.08E-06
39	-	-495.74E-06
Average	-	-515.57E-06
Sigma	-	81.29E-06

Test conditions : Protons

Parameter : Input Offset Voltage : VIO1DUTB

+VCC=30V. -VCC=GND. VCM=-15V

Unit : V

Spec Limit Min : -2.0E-03

Spec Limit Max : 2.0E-03

Spec limits are represented in bold lines on the graphic.

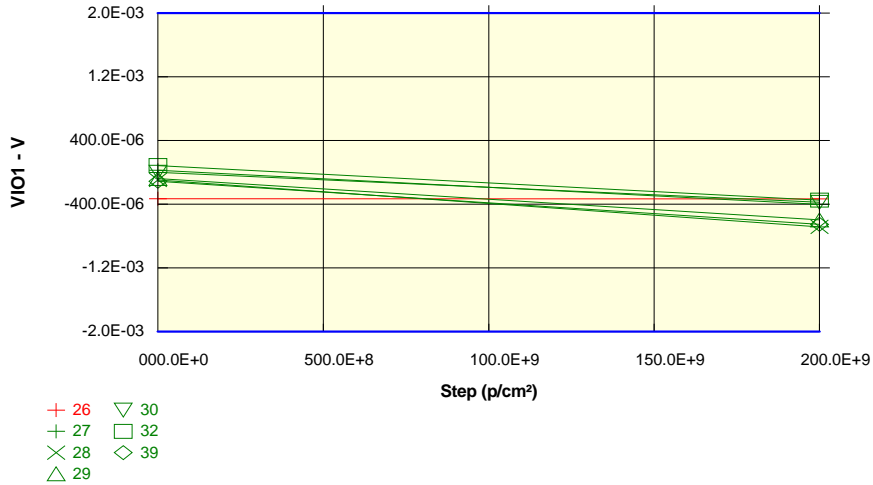

Measurements

VIO1DUTB	0 p/cm ²	2E+11 p/cm ²
26_REF	-331.0E-06	-333.1E-06
OFF samples		
27	26.2E-06	-402.8E-06
28	-97.2E-06	-684.8E-06
29	-78.0E-06	-597.6E-06
30	-656.0E-09	-377.1E-06
32	86.3E-06	-349.2E-06
39	-111.9E-06	-653.1E-06
Statistics		
Min	-111.9E-06	-684.8E-06
Max	86.3E-06	-349.2E-06
Average	-29.2E-06	-510.8E-06
Sigma	71.9E-06	137.7E-06

Drift Calculation

VIO1DUTB	0 p/cm ²	2E+11 p/cm ²
OFF samples		
27	-	-428.97E-06
28	-	-587.52E-06
29	-	-519.66E-06
30	-	-376.42E-06
32	-	-435.42E-06
39	-	-541.22E-06
Average	-	-481.53E-06
Sigma	-	73.24E-06

Test conditions : Protons

Parameter : Input Offset Voltage : VIO1DUTC

+VCC=30V, -VCC=GND, VCM=-15V

Unit : V

Spec Limit Min : -2.0E-03

Spec Limit Max : 2.0E-03

Spec limits are represented in bold lines on the graphic.

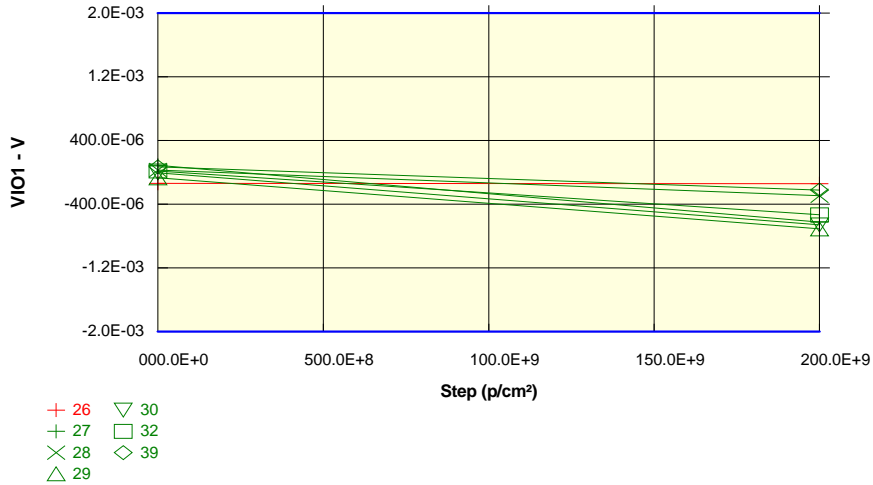

Measurements

VIO1DUTC	0 p/cm ²	2E+11 p/cm ²
26_REF	-137.6E-06	-141.7E-06
OFF samples		
27	87.2E-06	-624.8E-06
28	28.9E-06	-294.4E-06
29	-69.2E-06	-710.6E-06
30	-5.9E-06	-659.1E-06
32	16.3E-06	-534.0E-06
39	68.5E-06	-223.2E-06
Statistics		
Min	-69.2E-06	-710.6E-06
Max	87.2E-06	-223.2E-06
Average	21.0E-06	-507.7E-06
Sigma	51.0E-06	184.8E-06

Drift Calculation

VIO1DUTC	0 p/cm ²	2E+11 p/cm ²
OFF samples		
27	-	-712.00E-06
28	-	-323.28E-06
29	-	-641.36E-06
30	-	-653.14E-06
32	-	-550.33E-06
39	-	-291.72E-06
Average	-	-528.64E-06
Sigma	-	163.61E-06

Test conditions : Protons

Parameter : Input Offset Voltage : VIO1DUTD

+VCC=30V, -VCC=GND, VCM=-15V

Unit : V

Spec Limit Min : -2.0E-03

Spec Limit Max : 2.0E-03

Spec limits are represented in bold lines on the graphic.

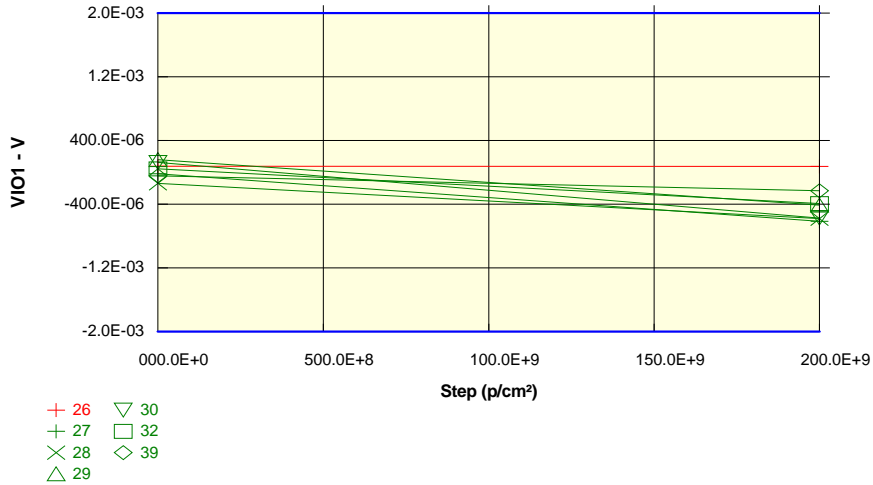

Measurements

VIO1DUTD	0 p/cm ²	2E+11 p/cm ²
26_REF	76.7E-06	73.2E-06
OFF samples		
27	-18.5E-06	-616.5E-06
28	-137.7E-06	-581.6E-06
29	158.6E-06	-412.3E-06
30	125.0E-06	-574.6E-06
32	44.6E-06	-393.2E-06
39	-43.5E-06	-232.4E-06
Statistics		
Min	-137.7E-06	-616.5E-06
Max	158.6E-06	-232.4E-06
Average	21.4E-06	-468.4E-06
Sigma	101.0E-06	135.7E-06

Drift Calculation

VIO1DUTD	0 p/cm ²	2E+11 p/cm ²
OFF samples		
27	-	-598.02E-06
28	-	-443.90E-06
29	-	-570.92E-06
30	-	-699.57E-06
32	-	-437.76E-06
39	-	-188.93E-06
Average	-	-489.85E-06
Sigma	-	162.09E-06

Hirex Engineering	Protons Test Report		Ref.:	HRX/TID/0934
	LM124AJRQMLV	National Semiconductors	Issue:	01

Test conditions : Protons

Parameter : Input Offset Voltage : VIO2DUTA

+VCC=2V. -VCC=-28V. VCM=13V

Unit : V

Spec Limit Min : -2.0E-03

Spec Limit Max : 2.0E-03

Spec limits are represented in bold lines on the graphic.

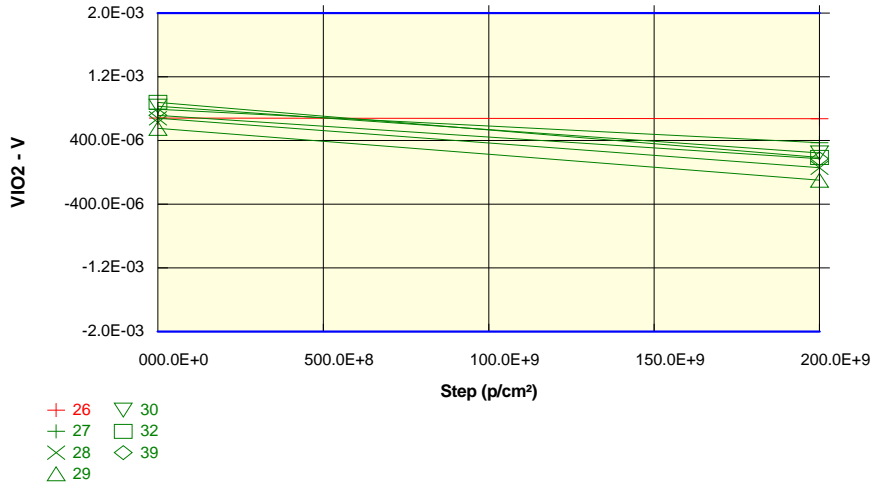

Measurements		
VIO2DUTA	0 p/cm ²	2E+11 p/cm ²
26_REF	680.2E-06	674.2E-06
OFF samples		
27	790.1E-06	372.0E-06
28	677.6E-06	58.7E-06
29	551.7E-06	-99.4E-06
30	830.4E-06	243.2E-06
32	879.2E-06	187.6E-06
39	714.7E-06	171.2E-06
Statistics		
Min	551.7E-06	-99.4E-06
Max	879.2E-06	372.0E-06
Average	740.6E-06	155.5E-06
Sigma	108.0E-06	147.3E-06

Drift Calculation		
VIO2DUTA	0 p/cm ²	2E+11 p/cm ²
OFF samples		
27	-	-418.12E-06
28	-	-618.93E-06
29	-	-651.10E-06
30	-	-587.20E-06
32	-	-691.57E-06
39	-	-543.51E-06
Average	-	-585.07E-06
Sigma	-	87.99E-06

Test conditions : Protons

Parameter : Input Offset Voltage : VIO2DUTB

+VCC=2V. -VCC=-28V. VCM=13V

Unit : V

Spec Limit Min : -2.0E-03

Spec Limit Max : 2.0E-03

Spec limits are represented in bold lines on the graphic.

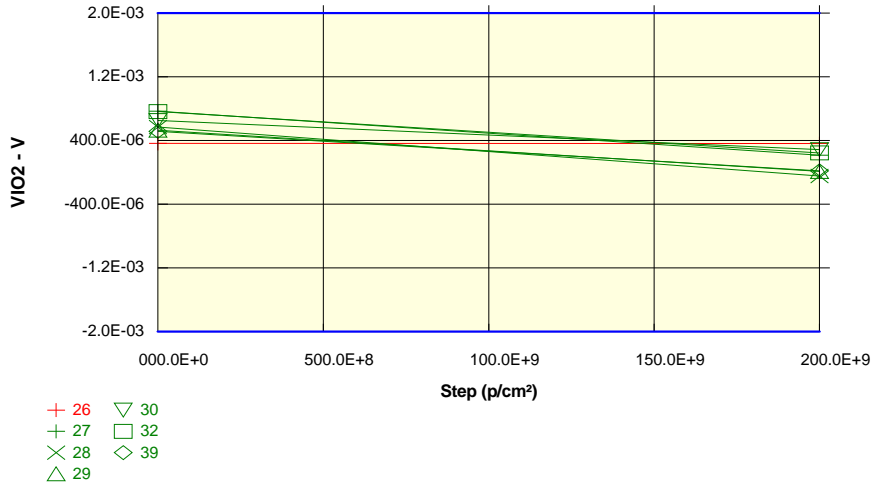

Measurements

VIO2DUTB	0 p/cm ²	2E+11 p/cm ²
26_REF	363.9E-06	360.4E-06
OFF samples		
27	769.2E-06	214.9E-06
28	568.7E-06	-46.8E-06
29	528.2E-06	11.4E-06
30	651.8E-06	285.9E-06
32	762.9E-06	242.9E-06
39	515.5E-06	18.7E-06
Statistics		
Min	515.5E-06	-46.8E-06
Max	769.2E-06	285.9E-06
Average	632.7E-06	121.2E-06
Sigma	103.8E-06	130.1E-06

Drift Calculation

VIO2DUTB	0 p/cm ²	2E+11 p/cm ²
OFF samples		
27	-	-554.32E-06
28	-	-615.49E-06
29	-	-516.81E-06
30	-	-365.92E-06
32	-	-520.00E-06
39	-	-496.86E-06
Average	-	-511.57E-06
Sigma	-	75.45E-06

Test conditions : Protons

Parameter : Input Offset Voltage : VIO2DUTC

+VCC=2V. -VCC=-28V. VCM=13V

Unit : V

Spec Limit Min : -2.0E-03

Spec Limit Max : 2.0E-03

Spec limits are represented in bold lines on the graphic.

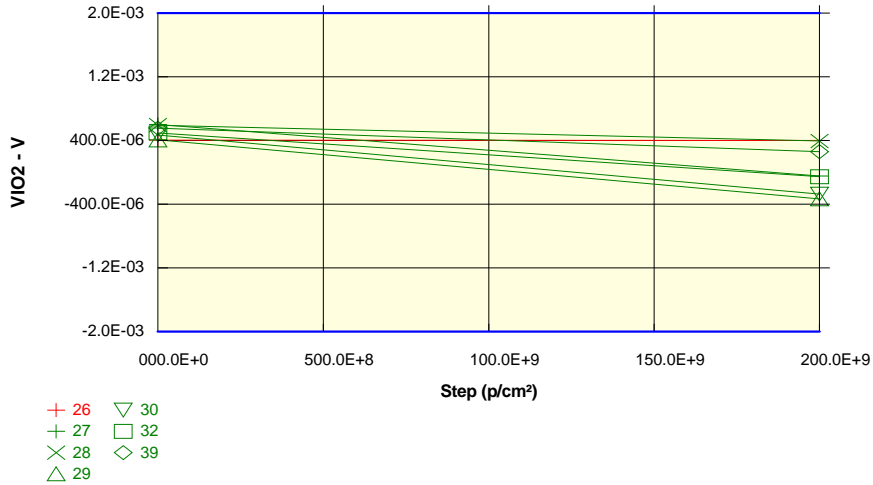

Measurements

VIO2DUTC	0 p/cm ²	2E+11 p/cm ²
26_REF	404.7E-06	401.1E-06
OFF samples		
27	600.7E-06	-45.0E-06
28	592.1E-06	392.8E-06
29	407.0E-06	-333.0E-06
30	468.9E-06	-272.5E-06
32	493.8E-06	-55.7E-06
39	554.6E-06	258.9E-06
Statistics		
Min	407.0E-06	-333.0E-06
Max	600.7E-06	392.8E-06
Average	519.5E-06	-9.1E-06
Sigma	69.5E-06	261.8E-06

Drift Calculation

VIO2DUTC	0 p/cm ²	2E+11 p/cm ²
OFF samples		
27	-	-645.66E-06
28	-	-199.24E-06
29	-	-740.00E-06
30	-	-741.40E-06
32	-	-549.59E-06
39	-	-295.68E-06
Average	-	-528.60E-06
Sigma	-	210.89E-06

Test conditions : Protons

Parameter : Input Offset Voltage : VIO2DUTD

+VCC=2V. -VCC=-28V. VCM=13V

Unit : V

Spec Limit Min : -2.0E-03

Spec Limit Max : 2.0E-03

Spec limits are represented in bold lines on the graphic.

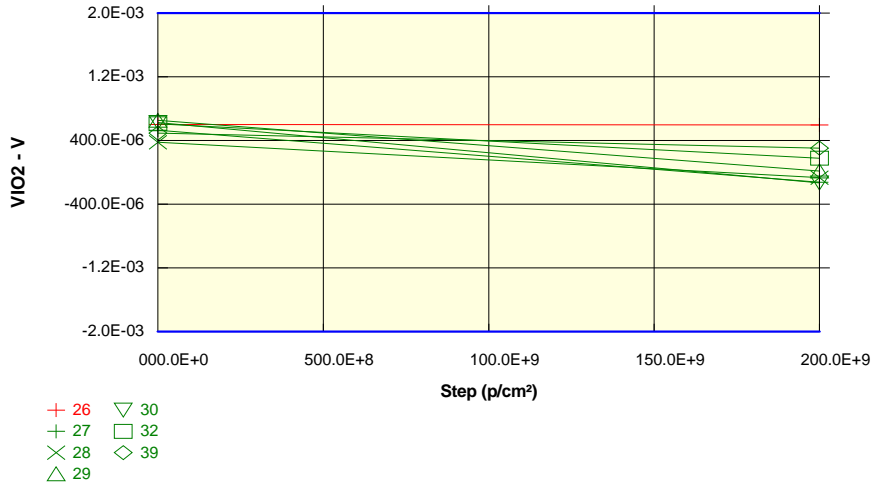

Measurements

VIO2DUTD	0 p/cm ²	2E+11 p/cm ²
26_REF	599.7E-06	594.5E-06
OFF samples		
27	528.7E-06	-124.4E-06
28	377.6E-06	-65.5E-06
29	652.4E-06	16.3E-06
30	625.4E-06	-133.1E-06
32	610.0E-06	176.7E-06
39	491.5E-06	303.2E-06
Statistics		
Min	377.6E-06	-133.1E-06
Max	652.4E-06	303.2E-06
Average	547.6E-06	28.9E-06
Sigma	94.3E-06	161.2E-06

Drift Calculation

VIO2DUTD	0 p/cm ²	2E+11 p/cm ²
OFF samples		
27	-	-653.13E-06
28	-	-443.08E-06
29	-	-636.11E-06
30	-	-758.50E-06
32	-	-433.26E-06
39	-	-188.36E-06
Average	-	-518.74E-06
Sigma	-	187.75E-06

Test conditions : Protons

Parameter : Input Offset Voltage : VIO3DUTA

+VCC=5V. -VCC=GND. VCM=-1.4V

Unit : V

Spec Limit Min : -2.0E-03

Spec Limit Max : 2.0E-03

Spec limits are represented in bold lines on the graphic.

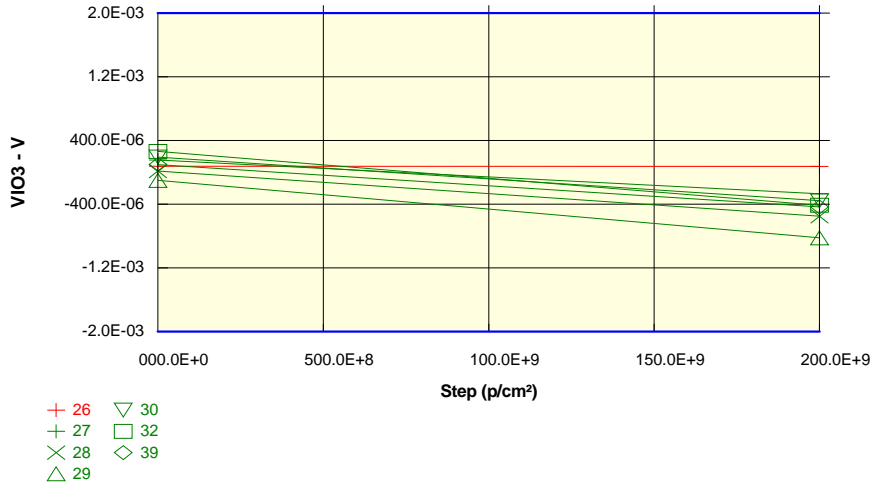

Measurements

VIO3DUTA	0 p/cm ²	2E+11 p/cm ²
26_REF	77.1E-06	73.9E-06
OFF samples		
27	154.3E-06	-267.9E-06
28	15.9E-06	-552.0E-06
29	-101.1E-06	-822.8E-06
30	190.6E-06	-355.4E-06
32	261.4E-06	-412.7E-06
39	97.2E-06	-434.8E-06
Statistics		
Min	-101.1E-06	-822.8E-06
Max	261.4E-06	-267.9E-06
Average	103.0E-06	-474.3E-06
Sigma	118.8E-06	177.8E-06

Drift Calculation

VIO3DUTA	0 p/cm ²	2E+11 p/cm ²
OFF samples		
27	-	-422.21E-06
28	-	-567.86E-06
29	-	-721.76E-06
30	-	-546.02E-06
32	-	-674.16E-06
39	-	-531.92E-06
Average	-	-577.32E-06
Sigma	-	97.83E-06

Hirex Engineering	Protons Test Report		Ref.:	HRX/TID/0934
	LM124AJRQMLV	National Semiconductors	Issue:	01

Test conditions : Protons

Parameter : Input Offset Voltage : VIO3DUTB

+VCC=5V. -VCC=GND. VCM=-1.4V

Unit : V

Spec Limit Min : -2.0E-03

Spec Limit Max : 2.0E-03

Spec limits are represented in bold lines on the graphic.

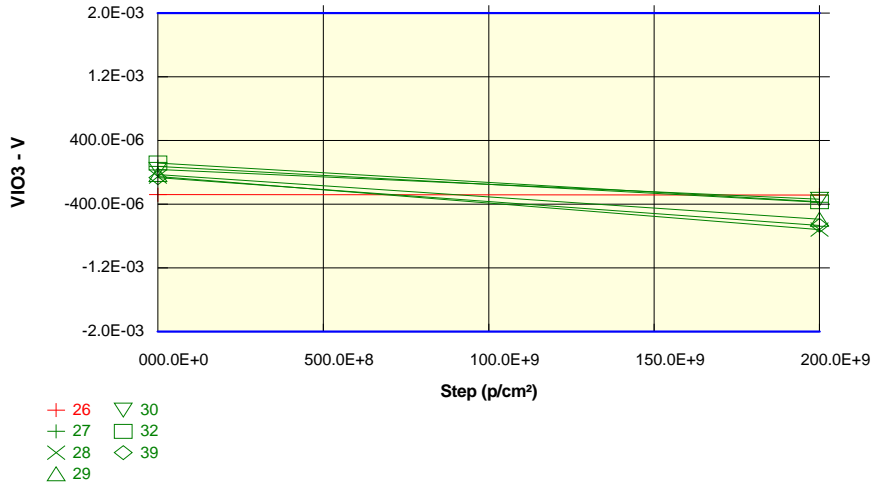

Measurements		
VIO3DUTB	0 p/cm ²	2E+11 p/cm ²
26_REF	-281.3E-06	-284.2E-06
OFF samples		
27	74.7E-06	-377.4E-06
28	-51.8E-06	-720.4E-06
29	-26.4E-06	-589.4E-06
30	36.3E-06	-336.7E-06
32	117.5E-06	-369.5E-06
39	-65.6E-06	-666.4E-06
Statistics		
Min	-65.6E-06	-720.4E-06
Max	117.5E-06	-336.7E-06
Average	14.1E-06	-509.9E-06
Sigma	67.3E-06	154.0E-06

Drift Calculation		
VIO3DUTB	0 p/cm ²	2E+11 p/cm ²
OFF samples		
27	-	-452.06E-06
28	-	-668.55E-06
29	-	-562.98E-06
30	-	-373.04E-06
32	-	-486.96E-06
39	-	-600.73E-06
Average	-	-524.05E-06
Sigma	-	98.01E-06

Test conditions : Protons

Parameter : Input Offset Voltage : VIO3DUTC

+VCC=5V. -VCC=GND. VCM=-1.4V

Unit : V

Spec Limit Min : -2.0E-03

Spec Limit Max : 2.0E-03

Spec limits are represented in bold lines on the graphic.

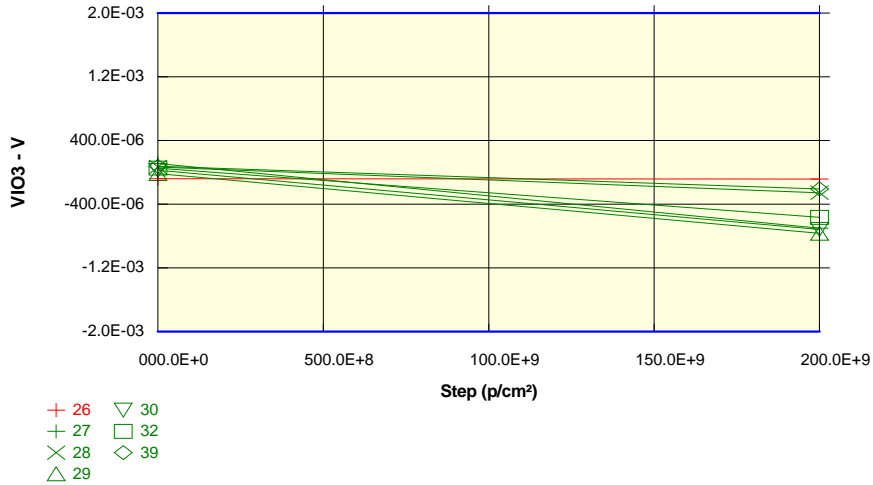

Measurements

VIO3DUTC	0 p/cm ²	2E+11 p/cm ²
26_REF	-81.0E-06	-85.0E-06
OFF samples		
27	110.1E-06	-700.6E-06
28	66.7E-06	-256.2E-06
29	-16.4E-06	-764.8E-06
30	24.8E-06	-716.7E-06
32	53.2E-06	-566.0E-06
39	75.5E-06	-209.8E-06
Statistics		
Min	-16.4E-06	-764.8E-06
Max	110.1E-06	-209.8E-06
Average	52.3E-06	-535.7E-06
Sigma	39.9E-06	222.7E-06

Drift Calculation

VIO3DUTC	0 p/cm ²	2E+11 p/cm ²
OFF samples		
27	-	-810.66E-06
28	-	-322.86E-06
29	-	-748.37E-06
30	-	-741.52E-06
32	-	-619.27E-06
39	-	-285.33E-06
Average	-	-588.00E-06
Sigma	-	208.87E-06

Test conditions : Protons

Parameter : Input Offset Voltage : VIO3DUTD

+VCC=5V. -VCC=GND. VCM=-1.4V

Unit : V

Spec Limit Min : -2.0E-03

Spec Limit Max : 2.0E-03

Spec limits are represented in bold lines on the graphic.

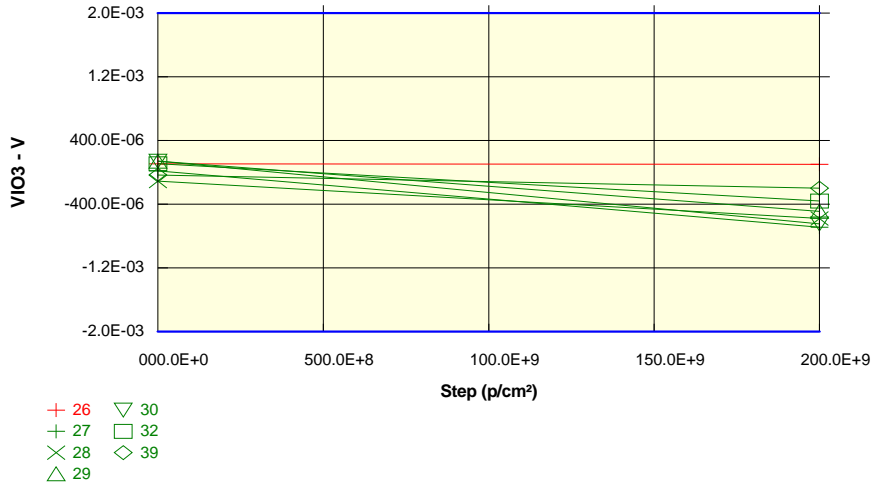

Measurements

VIO3DUTD	0 p/cm²	2E+11 p/cm²
26_REF	105.4E-06	102.3E-06
OFF samples		
27	19.6E-06	-689.2E-06
28	-110.8E-06	-579.3E-06
29	141.3E-06	-489.8E-06
30	141.2E-06	-648.3E-06
32	108.4E-06	-359.9E-06
39	-34.7E-06	-200.2E-06
Statistics		
Min	-110.8E-06	-689.2E-06
Max	141.3E-06	-200.2E-06
Average	44.2E-06	-494.4E-06
Sigma	94.7E-06	170.1E-06

Drift Calculation

VIO3DUTD	0 p/cm²	2E+11 p/cm²
OFF samples		
27	-	-708.79E-06
28	-	-468.52E-06
29	-	-631.10E-06
30	-	-789.49E-06
32	-	-468.36E-06
39	-	-165.45E-06
Average	-	-538.62E-06
Sigma	-	203.94E-06

Hirex Engineering	Protons Test Report		Ref.:	HRX/TID/0934
	LM124AJRQMLV	National Semiconductors	Issue:	01

Test conditions : Protons

Parameter : Input Offset Voltage : VIO4DUTA

+VCC=2.5V. -VCC=-2.5V. VCM=-1.1V

Unit : V

Spec Limit Min : -2.0E-03

Spec Limit Max : 2.0E-03

Spec limits are represented in bold lines on the graphic.

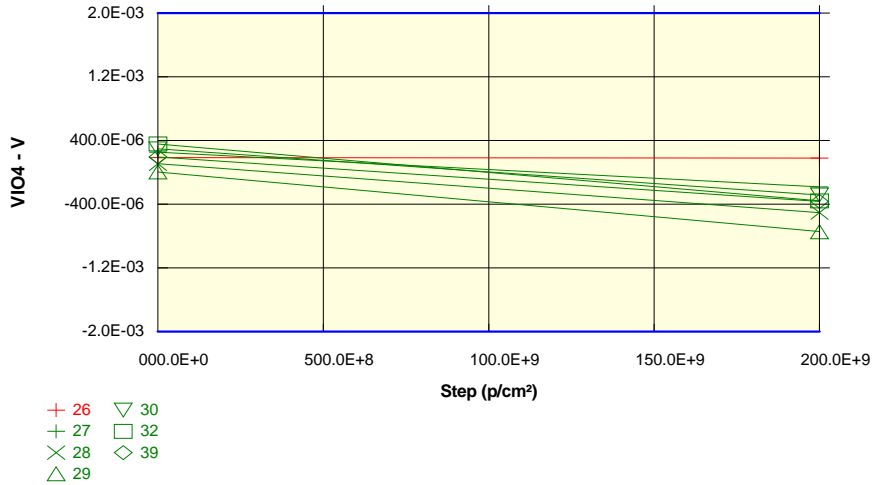

Measurements		
VIO4DUTA	0 p/cm ²	2E+11 p/cm ²
26_REF	183.6E-06	179.0E-06
OFF samples		
27	254.1E-06	-184.0E-06
28	108.7E-06	-506.0E-06
29	4.1E-06	-745.7E-06
30	295.0E-06	-284.8E-06
32	357.5E-06	-357.8E-06
39	194.2E-06	-365.5E-06
Statistics		
Min	4.1E-06	-745.7E-06
Max	357.5E-06	-184.0E-06
Average	202.3E-06	-407.3E-06
Sigma	117.9E-06	179.5E-06

Drift Calculation		
VIO4DUTA	0 p/cm ²	2E+11 p/cm ²
OFF samples		
27	-	-438.07E-06
28	-	-614.75E-06
29	-	-749.81E-06
30	-	-579.76E-06
32	-	-715.28E-06
39	-	-559.71E-06
Average	-	-609.56E-06
Sigma	-	103.00E-06

Test conditions : Protons

Parameter : Input Offset Voltage : VIO4DUTB

+VCC=2.5V. -VCC=-2.5V. VCM=-1.1V

Unit : V

Spec Limit Min : -2.0E-03

Spec Limit Max : 2.0E-03

Spec limits are represented in bold lines on the graphic.

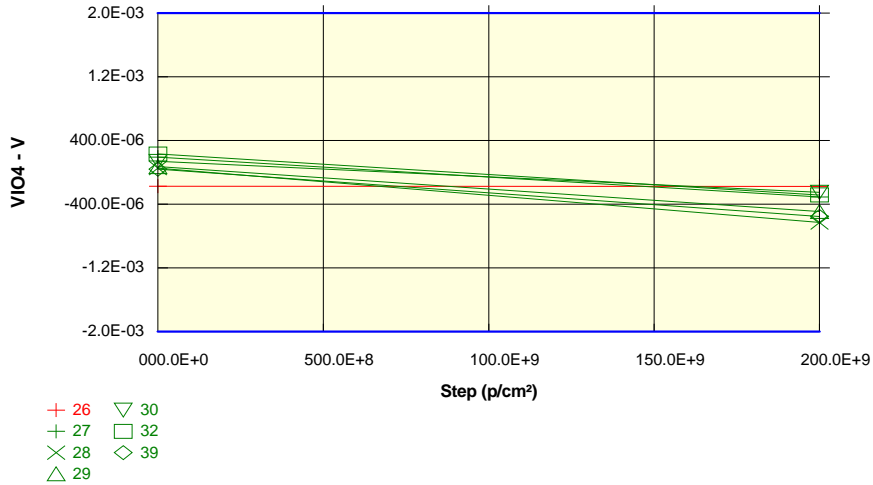

Measurements		
VIO4DUTB	0 p/cm ²	2E+11 p/cm ²
26_REF	-173.6E-06	-176.0E-06
OFF samples		
27	191.6E-06	-309.6E-06
28	53.4E-06	-630.7E-06
29	71.4E-06	-492.2E-06
30	137.8E-06	-250.1E-06
32	229.4E-06	-283.8E-06
39	39.6E-06	-554.7E-06
Statistics		
Min	39.6E-06	-630.7E-06
Max	229.4E-06	-250.1E-06
Average	120.6E-06	-420.2E-06
Sigma	71.5E-06	145.7E-06

Drift Calculation		
VIO4DUTB	0 p/cm ²	2E+11 p/cm ²
OFF samples		
27	-	-501.27E-06
28	-	-684.13E-06
29	-	-563.60E-06
30	-	-387.93E-06
32	-	-513.16E-06
39	-	-594.29E-06
Average	-	-540.73E-06
Sigma	-	90.94E-06

Test conditions : Protons

Parameter : Input Offset Voltage : VIO4DUTC

+VCC=2.5V. -VCC=-2.5V. VCM=-1.1V

Unit : V

Spec Limit Min : -2.0E-03

Spec Limit Max : 2.0E-03

Spec limits are represented in bold lines on the graphic.

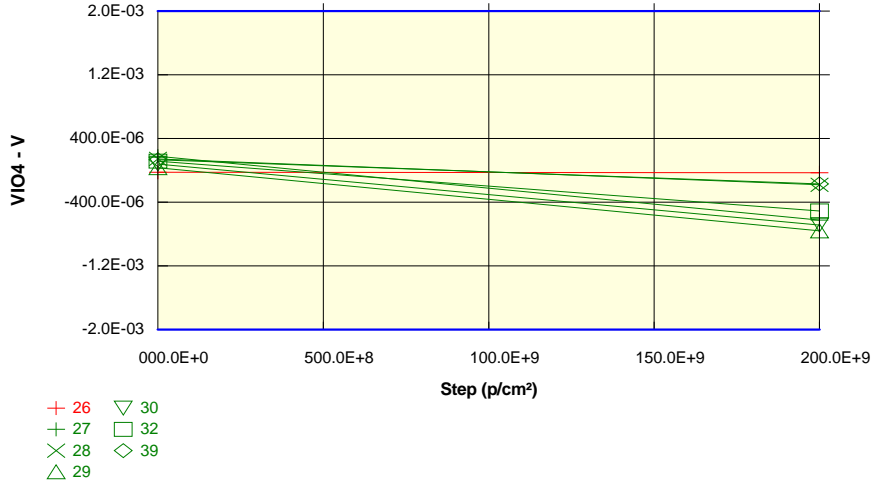

Measurements

VIO4DUTC	0 p/cm ²	2E+11 p/cm ²
26_REF	-25.9E-06	-28.8E-06
OFF samples		
27	177.3E-06	-625.4E-06
28	142.3E-06	-180.7E-06
29	32.8E-06	-759.7E-06
30	79.2E-06	-687.8E-06
32	114.3E-06	-509.2E-06
39	133.4E-06	-169.4E-06
Statistics		
Min	32.8E-06	-759.7E-06
Max	177.3E-06	-169.4E-06
Average	113.2E-06	-488.7E-06
Sigma	46.5E-06	234.2E-06

Drift Calculation

VIO4DUTC	0 p/cm ²	2E+11 p/cm ²
OFF samples		
27	-	-802.62E-06
28	-	-322.94E-06
29	-	-792.56E-06
30	-	-766.99E-06
32	-	-623.50E-06
39	-	-302.77E-06
Average	-	-601.90E-06
Sigma	-	212.78E-06

Hirex Engineering	Protons Test Report		Ref.:	HRX/TID/0934
	LM124AJRQMLV	National Semiconductors	Issue:	01

Test conditions : Protons

Parameter : Input Offset Voltage : VIO4DUTD

+VCC=2.5V. -VCC=-2.5V. VCM=-1.1V

Unit : V

Spec Limit Min : -2.0E-03

Spec Limit Max : 2.0E-03

Spec limits are represented in bold lines on the graphic.

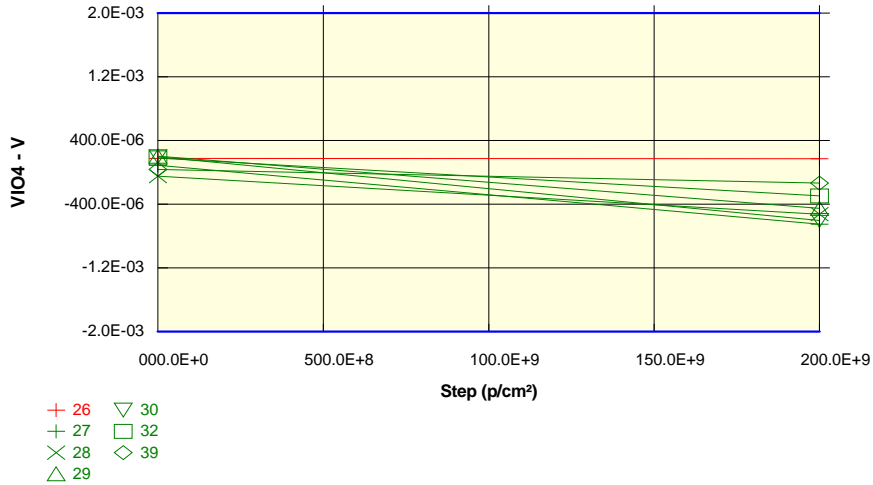

Measurements		
VIO4DUTD	0 p/cm ²	2E+11 p/cm ²
26_REF	174.1E-06	169.3E-06
OFF samples		
27	88.6E-06	-649.9E-06
28	-47.4E-06	-526.7E-06
29	202.6E-06	-452.6E-06
30	195.1E-06	-605.1E-06
32	180.6E-06	-297.2E-06
39	36.5E-06	-134.5E-06
Statistics		
Min	-47.4E-06	-649.9E-06
Max	202.6E-06	-134.5E-06
Average	109.4E-06	-444.3E-06
Sigma	92.6E-06	179.2E-06

Drift Calculation		
VIO4DUTD	0 p/cm ²	2E+11 p/cm ²
OFF samples		
27	-	-738.57E-06
28	-	-479.32E-06
29	-	-655.24E-06
30	-	-800.22E-06
32	-	-477.79E-06
39	-	-171.03E-06
Average	-	-553.69E-06
Sigma	-	209.36E-06

Test conditions : Protons

Parameter : Input Offset Current : IIO1DUTA

+VCC=30V. -VCC=GND. VCM=-15V

Unit : A

Spec Limit Min : -10.0E-09

Spec Limit Max : 10.0E-09

Spec limits are represented in bold lines on the graphic.

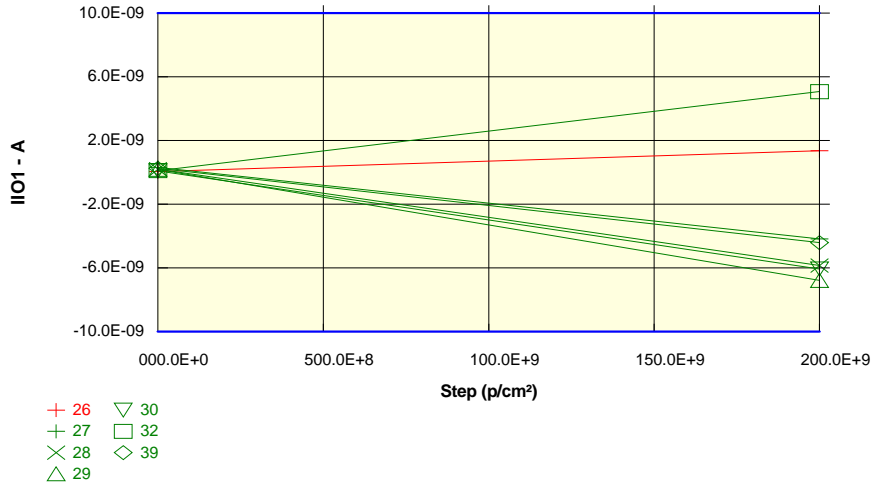

Measurements

IIO1DUTA	0 p/cm ²	2E+11 p/cm ²
26_REF	46.8E-12	1.4E-09
OFF samples		
27	306.2E-12	-4.2E-09
28	198.0E-12	-5.9E-09
29	189.6E-12	-6.8E-09
30	94.2E-12	-6.1E-09
32	110.0E-12	5.1E-09
39	250.2E-12	-4.4E-09
Statistics		
Min	94.2E-12	-6.8E-09
Max	306.2E-12	5.1E-09
Average	191.4E-12	-3.7E-09
Sigma	73.9E-12	4.0E-09

Drift Calculation

IIO1DUTA	0 p/cm ²	2E+11 p/cm ²
OFF samples		
27	-	-4.49E-09
28	-	-6.05E-09
29	-	-6.98E-09
30	-	-6.16E-09
32	-	4.95E-09
39	-	-4.66E-09
Average	-	-3.90E-09
Sigma	-	4.05E-09

Hirex Engineering	Protons Test Report		Ref.:	HRX/TID/0934
	LM124AJRQMLV	National Semiconductors	Issue:	01

Test conditions : Protons

Parameter : Input Offset Current : IIO1DUTB

+VCC=30V. -VCC=GND. VCM=-15V

Unit : A

Spec Limit Min : -10.0E-09

Spec Limit Max : 10.0E-09

Spec limits are represented in bold lines on the graphic.

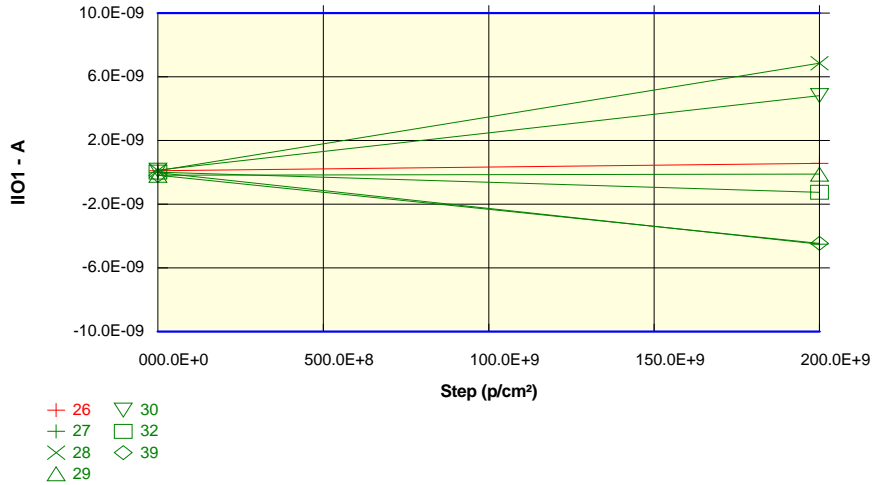

Measurements

IIO1DUTB	0 p/cm²	2E+11 p/cm²
26_REF	110.0E-12	568.3E-12
OFF samples		
27	-21.8E-12	-4.5E-09
28	110.0E-12	6.9E-09
29	-182.2E-12	-117.0E-12
30	133.4E-12	4.8E-09
32	14.4E-12	-1.3E-09
39	-186.2E-12	-4.5E-09
Statistics		
Min	-186.2E-12	-4.5E-09
Max	133.4E-12	6.9E-09
Average	-22.1E-12	220.1E-12
Sigma	126.2E-12	4.3E-09

Drift Calculation

IIO1DUTB	0 p/cm²	2E+11 p/cm²
OFF samples		
27	-	-4.49E-09
28	-	6.74E-09
29	-	65.19E-12
30	-	4.68E-09
32	-	-1.27E-09
39	-	-4.28E-09
Average	-	242.15E-12
Sigma	-	4.23E-09

Hirex Engineering	Protons Test Report		Ref.:	HRX/TID/0934
	LM124AJRQLV	National Semiconductors	Issue:	01

Test conditions : Protons

Parameter : Input Offset Current : IIO1DUTC

+VCC=30V, -VCC=GND, VCM=-15V

Unit : A

Spec Limit Min : -10.0E-09

Spec Limit Max : 10.0E-09

Spec limits are represented in bold lines on the graphic.

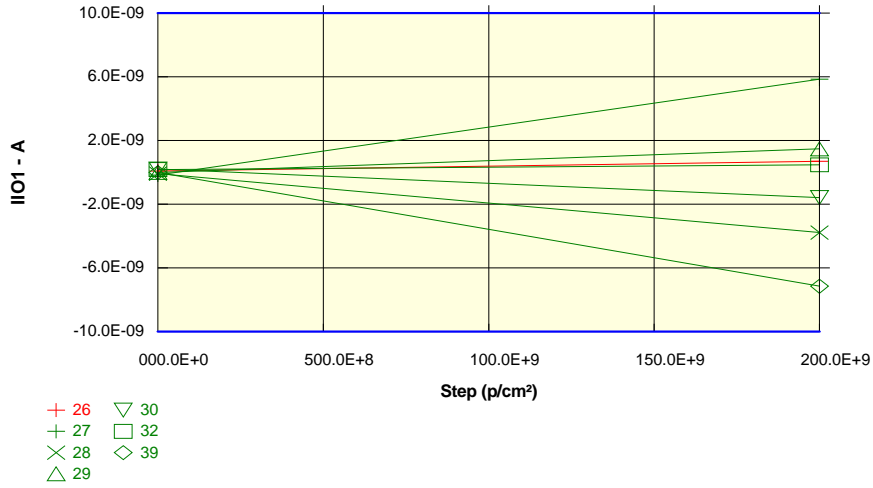

Measurements

IIO1DUTC	0 p/cm²	2E+11 p/cm²
26_REF	83.6E-12	688.7E-12
OFF samples		
27	-167.4E-12	5.9E-09
28	-85.0E-12	-3.8E-09
29	-13.4E-12	1.5E-09
30	207.2E-12	-1.6E-09
32	170.8E-12	468.0E-12
39	-10.6E-12	-7.2E-09
Statistics		
Min	-167.4E-12	-7.2E-09
Max	207.2E-12	5.9E-09
Average	16.9E-12	-788.4E-12
Sigma	132.9E-12	4.1E-09

Drift Calculation

IIO1DUTC	0 p/cm²	2E+11 p/cm²
OFF samples		
27	-	6.02E-09
28	-	-3.69E-09
29	-	1.48E-09
30	-	-1.80E-09
32	-	297.23E-12
39	-	-7.14E-09
Average	-	-805.34E-12
Sigma	-	4.13E-09

Test conditions : Protons

Parameter : Input Offset Current : IIO1DUTD

+VCC=30V, -VCC=GND, VCM=-15V

Unit : A

Spec Limit Min : -10.0E-09

Spec Limit Max : 10.0E-09

Spec limits are represented in bold lines on the graphic.

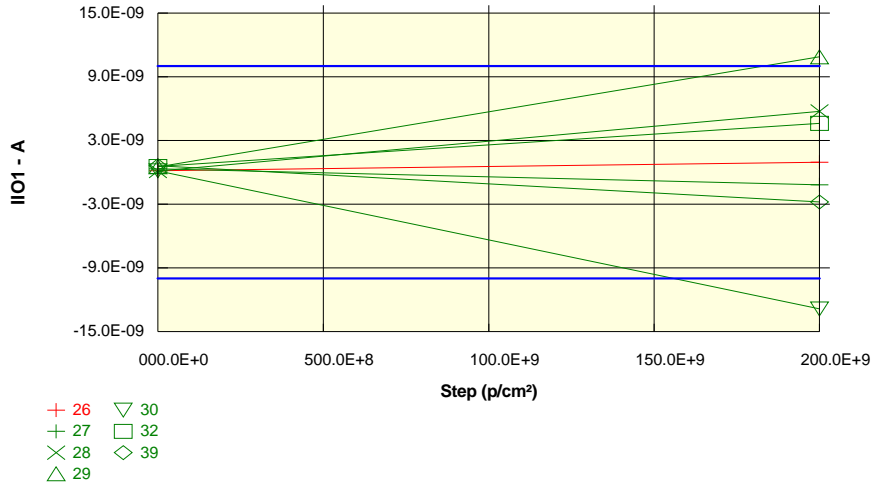

Measurements

IIO1DUTD	0 p/cm ²	2E+11 p/cm ²
26_REF	163.0E-12	947.8E-12
OFF samples		
27	327.0E-12	-1.2E-09
28	124.2E-12	5.8E-09
29	518.8E-12	10.9E-09
30	141.0E-12	-12.9E-09
32	558.0E-12	4.6E-09
39	622.8E-12	-2.8E-09
Statistics		
Min	124.2E-12	-12.9E-09
Max	622.8E-12	10.9E-09
Average	382.0E-12	738.3E-12
Sigma	198.0E-12	7.6E-09

Drift Calculation

IIO1DUTD	0 p/cm ²	2E+11 p/cm ²
OFF samples		
27	-	-1.50E-09
28	-	5.63E-09
29	-	10.36E-09
30	-	-13.00E-09
32	-	4.06E-09
39	-	-3.41E-09
Average	-	356.30E-12
Sigma	-	7.50E-09

Hirex Engineering	Protons Test Report		Ref.:	HRX/TID/0934
	LM124AJRQMLV	National Semiconductors	Issue:	01

Test conditions : Protons

Parameter : Input Offset Current : IIO2DUTA

+VCC=2V. -VCC=-28V. VCM=13V

Unit : A

Spec Limit Min : -10.0E-09

Spec Limit Max : 10.0E-09

Spec limits are represented in bold lines on the graphic.

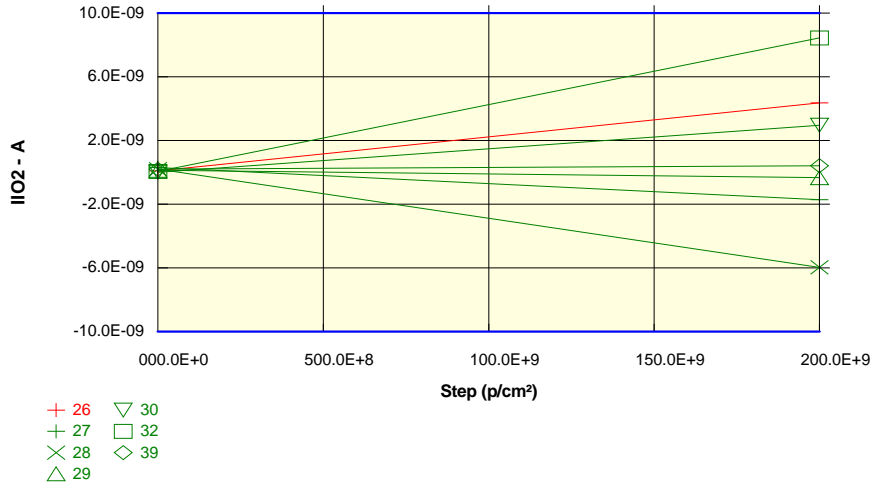

Measurements

IIO2DUTA	0 p/cm²	2E+11 p/cm²
26_REF	88.0E-12	4.4E-09
OFF samples		
27	302.0E-12	-1.7E-09
28	194.0E-12	-6.0E-09
29	124.0E-12	-336.0E-12
30	6.0E-12	3.0E-09
32	58.0E-12	8.4E-09
39	192.0E-12	417.9E-12
Statistics		
Min	6.0E-12	-6.0E-09
Max	302.0E-12	8.4E-09
Average	146.0E-12	632.4E-12
Sigma	97.1E-12	4.4E-09

Drift Calculation

IIO2DUTA	0 p/cm²	2E+11 p/cm²
OFF samples		
27	-	-2.02E-09
28	-	-6.16E-09
29	-	-459.98E-12
30	-	2.95E-09
32	-	8.38E-09
39	-	225.89E-12
Average	-	486.40E-12
Sigma	-	4.47E-09

Test conditions : Protons

Parameter : Input Offset Current : IIO2DUTB

+VCC=2V. -VCC=-28V. VCM=13V

Unit : A

Spec Limit Min : -10.0E-09

Spec Limit Max : 10.0E-09

Spec limits are represented in bold lines on the graphic.

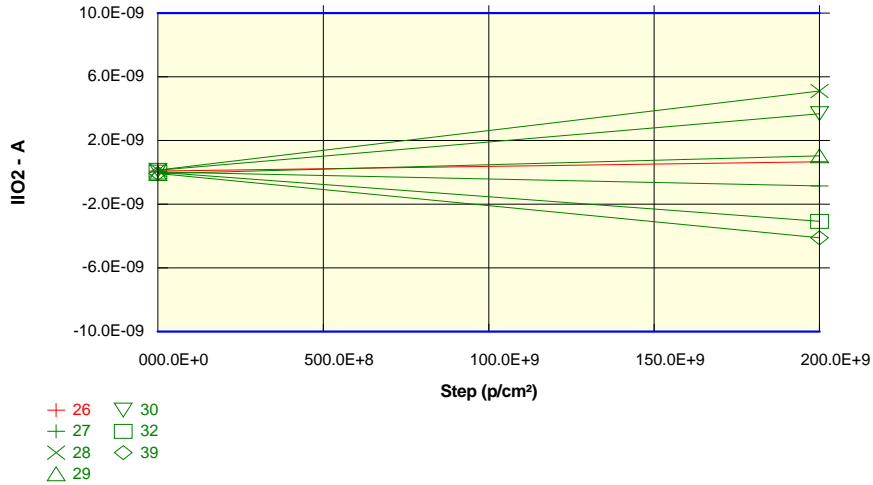

Measurements

IIO2DUTB	0 p/cm²	2E+11 p/cm²
26_REF	80.0E-12	668.6E-12
OFF samples		
27	28.0E-12	-852.5E-12
28	142.0E-12	5.1E-09
29	-78.0E-12	1.0E-09
30	124.0E-12	3.7E-09
32	14.0E-12	-3.1E-09
39	-72.0E-12	-4.1E-09
Statistics		
Min	-78.0E-12	-4.1E-09
Max	142.0E-12	5.1E-09
Average	26.3E-12	295.0E-12
Sigma	85.3E-12	3.3E-09

Drift Calculation

IIO2DUTB	0 p/cm²	2E+11 p/cm²
OFF samples		
27	-	-880.49E-12
28	-	4.96E-09
29	-	1.12E-09
30	-	3.55E-09
32	-	-3.09E-09
39	-	-4.05E-09
Average	-	268.69E-12
Sigma	-	3.28E-09

Test conditions : Protons

Parameter : Input Offset Current : IIO2DUTC

+VCC=2V. -VCC=-28V. VCM=13V

Unit : A

Spec Limit Min : -10.0E-09

Spec Limit Max : 10.0E-09

Spec limits are represented in bold lines on the graphic.

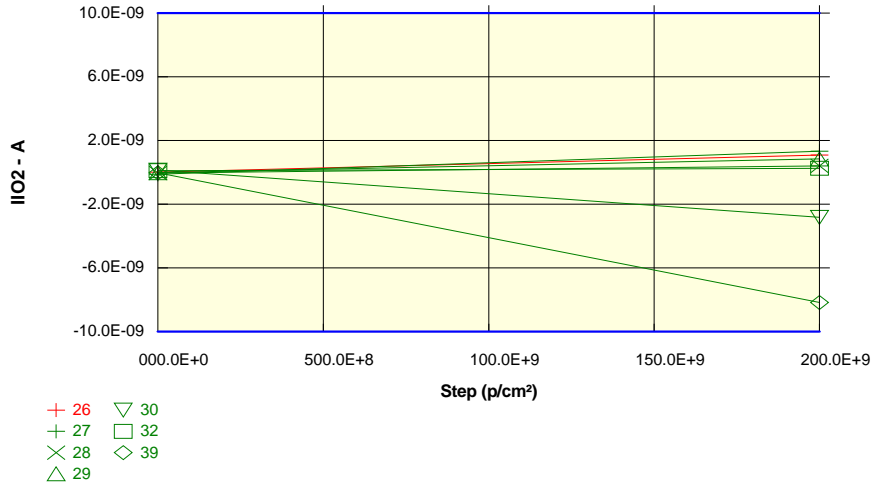

Measurements

IIO2DUTC	0 p/cm ²	2E+11 p/cm ²
26_REF	8.0E-12	1.1E-09
OFF samples		
27	-128.0E-12	1.3E-09
28	-42.0E-12	401.2E-12
29	-18.0E-12	835.8E-12
30	134.0E-12	-2.8E-09
32	100.0E-12	250.7E-12
39	-28.0E-12	-8.2E-09
Statistics		
Min	-128.0E-12	-8.2E-09
Max	134.0E-12	1.3E-09
Average	3.0E-12	-1.4E-09
Sigma	88.7E-12	3.3E-09

Drift Calculation

IIO2DUTC	0 p/cm ²	2E+11 p/cm ²
OFF samples		
27	-	1.45E-09
28	-	443.17E-12
29	-	853.77E-12
30	-	-2.96E-09
32	-	150.73E-12
39	-	-8.15E-09
Average	-	-1.37E-09
Sigma	-	3.34E-09

Test conditions : Protons

Parameter : Input Offset Current : IIO2DUTD

+VCC=2V. -VCC=-28V. VCM=13V

Unit : A

Spec Limit Min : -10.0E-09

Spec Limit Max : 10.0E-09

Spec limits are represented in bold lines on the graphic.

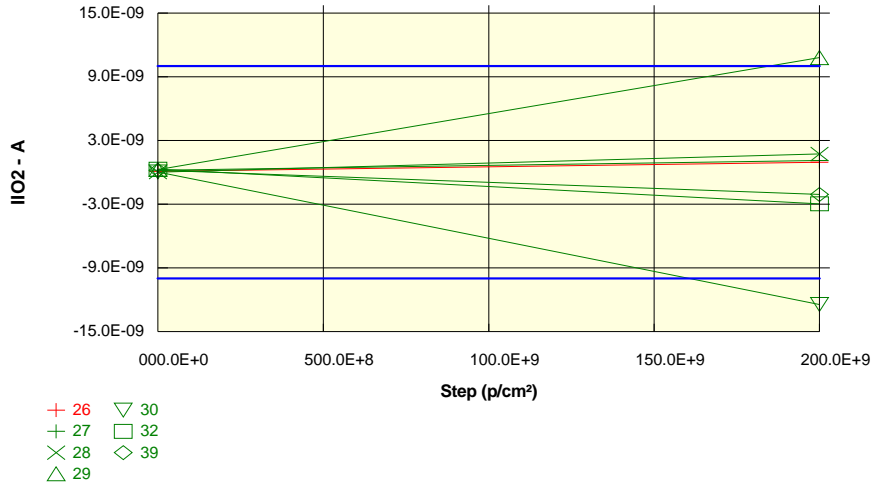

Measurements

IIO2DUTD	0 p/cm ²	2E+11 p/cm ²
26_REF	94.0E-12	952.8E-12
OFF samples		
27	188.0E-12	1.1E-09
28	22.0E-12	1.7E-09
29	254.0E-12	10.8E-09
30	34.0E-12	-12.4E-09
32	292.0E-12	-3.0E-09
39	190.0E-12	-2.1E-09
Statistics		
Min	22.0E-12	-12.4E-09
Max	292.0E-12	10.8E-09
Average	163.3E-12	-641.9E-12
Sigma	102.3E-12	6.9E-09

Drift Calculation

IIO2DUTD	0 p/cm ²	2E+11 p/cm ²
OFF samples		
27	-	928.59E-12
28	-	1.71E-09
29	-	10.55E-09
30	-	-12.48E-09
32	-	-3.26E-09
39	-	-2.28E-09
Average	-	-805.21E-12
Sigma	-	6.86E-09

Hirex Engineering	Protons Test Report		Ref.:	HRX/TID/0934
	LM124AJRQMLV	National Semiconductors	Issue:	01

Test conditions : Protons

Parameter : Input Offset Current : IIO3DUTA

+VCC=5V. -VCC=GND. VCM=-1.4V

Unit : A

Spec Limit Min : -10.0E-09

Spec Limit Max : 10.0E-09

Spec limits are represented in bold lines on the graphic.

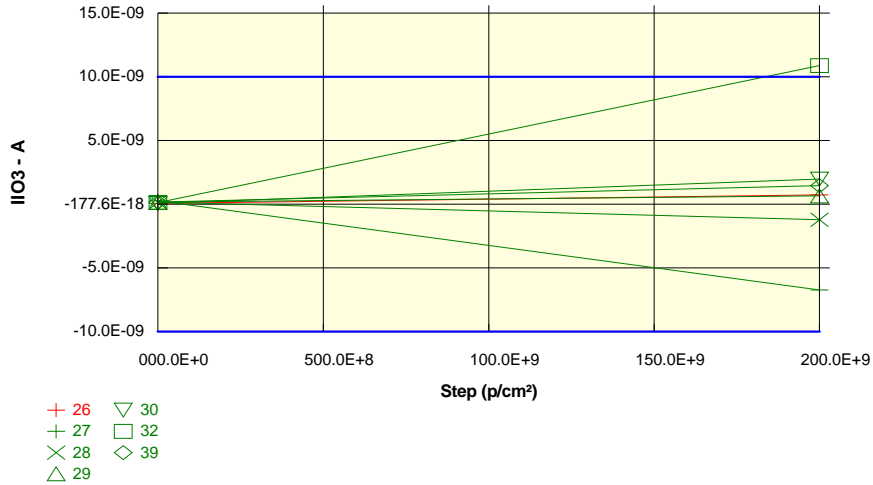

Measurements

IIO3DUTA	0 p/cm²	2E+11 p/cm²
26_REF	55.2E-12	732.1E-12
OFF samples		
27	259.6E-12	-6.7E-09
28	157.4E-12	-1.2E-09
29	155.4E-12	651.9E-12
30	61.2E-12	2.0E-09
32	136.0E-12	10.9E-09
39	158.2E-12	1.5E-09
Statistics		
Min	61.2E-12	-6.7E-09
Max	259.6E-12	10.9E-09
Average	154.6E-12	1.2E-09
Sigma	57.9E-12	5.2E-09

Drift Calculation

IIO3DUTA	0 p/cm²	2E+11 p/cm²
OFF samples		
27	-	-7.00E-09
28	-	-1.38E-09
29	-	496.51E-12
30	-	1.91E-09
32	-	10.75E-09
39	-	1.30E-09
Average	-	1.01E-09
Sigma	-	5.26E-09

Test conditions : Protons

Parameter : Input Offset Current : IIO3DUTB

+VCC=5V. -VCC=GND. VCM=-1.4V

Unit : A

Spec Limit Min : -10.0E-09

Spec Limit Max : 10.0E-09

Spec limits are represented in bold lines on the graphic.

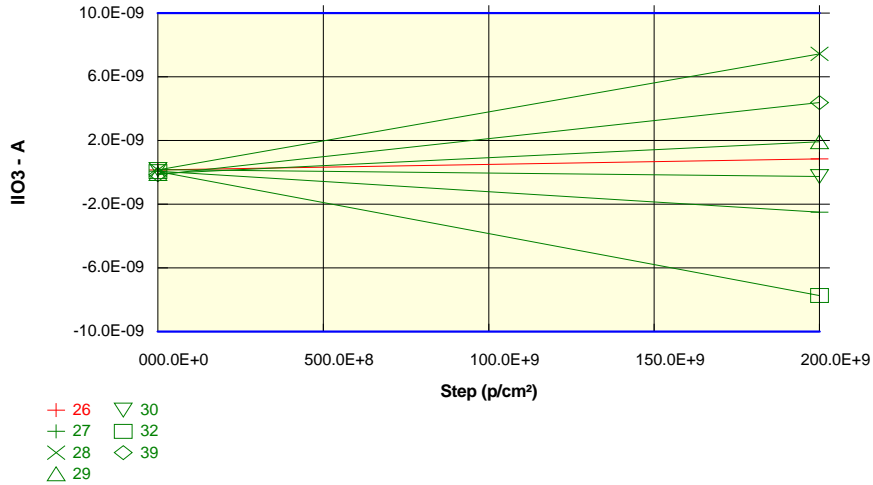

Measurements		
IIO3DUTB	0 p/cm²	2E+11 p/cm²
26_REF	146.0E-12	835.8E-12
OFF samples		
27	75.8E-12	-2.5E-09
28	150.8E-12	7.4E-09
29	-82.8E-12	1.9E-09
30	178.4E-12	-267.4E-12
32	44.4E-12	-7.7E-09
39	-144.6E-12	4.4E-09
Statistics		
Min	-144.6E-12	-7.7E-09
Max	178.4E-12	7.4E-09
Average	37.0E-12	537.7E-12
Sigma	116.8E-12	4.9E-09

Drift Calculation		
IIO3DUTB	0 p/cm²	2E+11 p/cm²
OFF samples		
27	-	-2.58E-09
28	-	7.29E-09
29	-	2.01E-09
30	-	-445.84E-12
32	-	-7.78E-09
39	-	4.52E-09
Average	-	500.68E-12
Sigma	-	4.89E-09

Test conditions : Protons

Parameter : Input Offset Current : IIO3DUTC

+VCC=5V. -VCC=GND. VCM=-1.4V

Unit : A

Spec Limit Min : -10.0E-09

Spec Limit Max : 10.0E-09

Spec limits are represented in bold lines on the graphic.

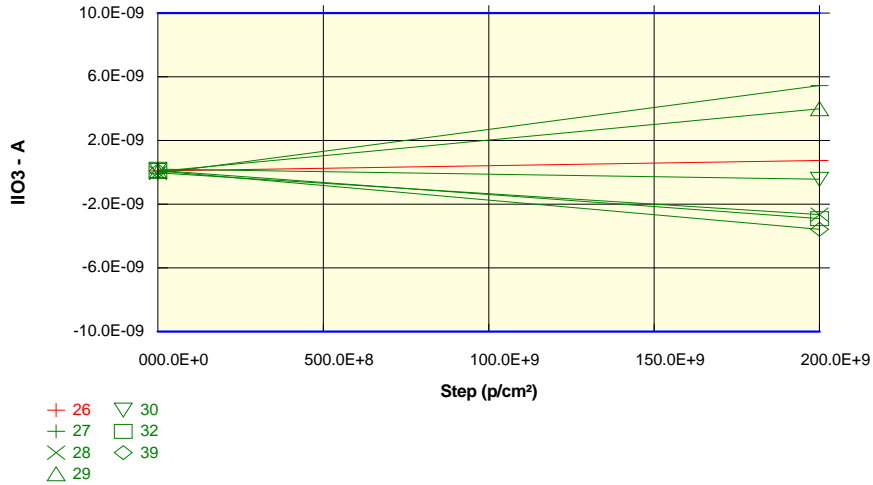

Measurements

IIO3DUTC	0 p/cm²	2E+11 p/cm²
26_REF	91.4E-12	743.8E-12
OFF samples		
27	-54.8E-12	5.4E-09
28	-31.2E-12	-2.7E-09
29	56.8E-12	4.0E-09
30	197.2E-12	-434.6E-12
32	112.4E-12	-2.9E-09
39	87.6E-12	-3.6E-09
Statistics		
Min	-54.8E-12	-3.6E-09
Max	197.2E-12	5.4E-09
Average	61.3E-12	-22.3E-12
Sigma	85.5E-12	3.5E-09

Drift Calculation

IIO3DUTC	0 p/cm²	2E+11 p/cm²
OFF samples		
27	-	5.50E-09
28	-	-2.63E-09
29	-	3.94E-09
30	-	-631.79E-12
32	-	-3.02E-09
39	-	-3.66E-09
Average	-	-83.62E-12
Sigma	-	3.55E-09

Test conditions : Protons

Parameter : Input Offset Current : IIO3DUTD

+VCC=5V. -VCC=GND. VCM=-1.4V

Unit : A

Spec Limit Min : -10.0E-09

Spec Limit Max : 10.0E-09

Spec limits are represented in bold lines on the graphic.

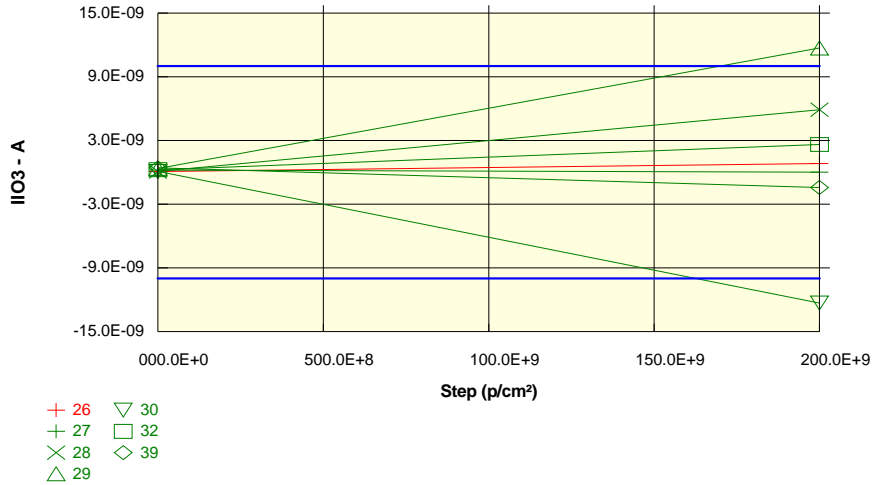

Measurements

IIO3DUTD	0 p/cm²	2E+11 p/cm²
26_REF	65.4E-12	822.4E-12
OFF samples		
27	204.6E-12	16.7E-12
28	80.0E-12	5.9E-09
29	364.4E-12	11.7E-09
30	80.4E-12	-12.3E-09
32	248.4E-12	2.6E-09
39	411.2E-12	-1.4E-09
Statistics		
Min	80.0E-12	-12.3E-09
Max	411.2E-12	11.7E-09
Average	231.5E-12	1.1E-09
Sigma	127.0E-12	7.4E-09

Drift Calculation

IIO3DUTD	0 p/cm²	2E+11 p/cm²
OFF samples		
27	-	-187.90E-12
28	-	5.82E-09
29	-	11.35E-09
30	-	-12.38E-09
32	-	2.38E-09
39	-	-1.84E-09
Average	-	857.23E-12
Sigma	-	7.31E-09

Test conditions : Protons

Parameter : Input Offset Current : IIO4DUTA

+VCC=2.5V. -VCC=-2.5V. VCM=-1.1V

Unit : A

Spec Limit Min : -10.0E-09

Spec Limit Max : 10.0E-09

Spec limits are represented in bold lines on the graphic.

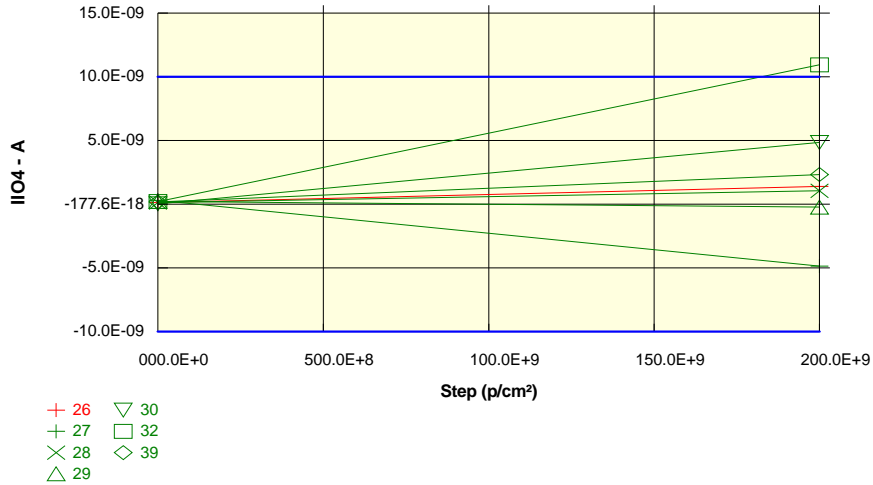

Measurements

IIO4DUTA	0 p/cm²	2E+11 p/cm²
26_REF	132.8E-12	1.4E-09
OFF samples		
27	310.0E-12	-4.9E-09
28	125.6E-12	1.1E-09
29	214.4E-12	-234.0E-12
30	30.0E-12	4.8E-09
32	200.0E-12	10.9E-09
39	176.8E-12	2.3E-09
Statistics		
Min	30.0E-12	-4.9E-09
Max	310.0E-12	10.9E-09
Average	176.1E-12	2.3E-09
Sigma	85.5E-12	4.8E-09

Drift Calculation

IIO4DUTA	0 p/cm²	2E+11 p/cm²
OFF samples		
27	-	-5.16E-09
28	-	927.47E-12
29	-	-448.41E-12
30	-	4.82E-09
32	-	10.73E-09
39	-	2.15E-09
Average	-	2.17E-09
Sigma	-	4.87E-09

Hirex Engineering	Protons Test Report		Ref.:	HRX/TID/0934
	LM124AJRQMLV	National Semiconductors	Issue:	01

Test conditions : Protons

Parameter : Input Offset Current : IIO4DUTB

+VCC=2.5V. -VCC=-2.5V. VCM=-1.1V

Unit : A

Spec Limit Min : -10.0E-09

Spec Limit Max : 10.0E-09

Spec limits are represented in bold lines on the graphic.

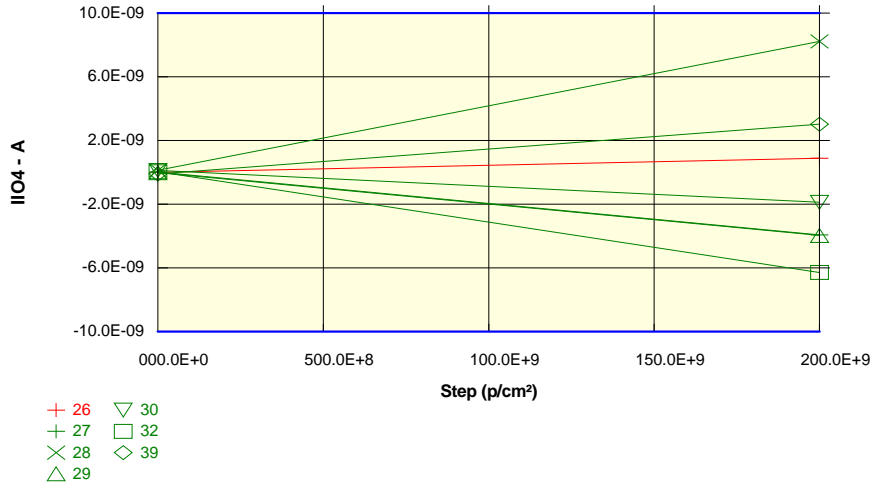

Measurements		
IIO4DUTB	0 p/cm²	2E+11 p/cm²
26_REF	-3.0E-12	885.9E-12
OFF samples		
27	25.6E-12	-3.9E-09
28	127.2E-12	8.2E-09
29	-22.2E-12	-4.0E-09
30	111.4E-12	-1.9E-09
32	38.0E-12	-6.3E-09
39	-103.2E-12	3.0E-09
Statistics		
Min	-103.2E-12	-6.3E-09
Max	127.2E-12	8.2E-09
Average	29.5E-12	-802.3E-12
Sigma	78.1E-12	5.0E-09

Drift Calculation		
IIO4DUTB	0 p/cm²	2E+11 p/cm²
OFF samples		
27	-	-3.95E-09
28	-	8.10E-09
29	-	-3.94E-09
30	-	-2.00E-09
32	-	-6.32E-09
39	-	3.13E-09
Average	-	-831.81E-12
Sigma	-	4.94E-09

Test conditions : Protons

Parameter : Input Offset Current : IIO4DUTC

+VCC=2.5V. -VCC=-2.5V. VCM=-1.1V

Unit : A

Spec Limit Min : -10.0E-09

Spec Limit Max : 10.0E-09

Spec limits are represented in bold lines on the graphic.

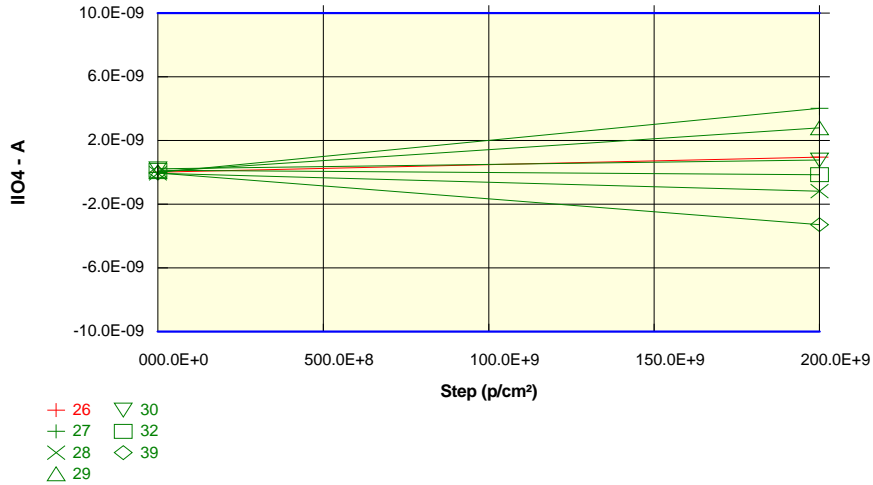

Measurements

IIO4DUTC	0 p/cm ²	2E+11 p/cm ²
26_REF	16.4E-12	954.5E-12
OFF samples		
27	-6.8E-12	4.0E-09
28	-61.4E-12	-1.2E-09
29	42.6E-12	2.8E-09
30	219.2E-12	768.9E-12
32	128.4E-12	-150.4E-12
39	-45.0E-12	-3.3E-09
Statistics		
Min	-61.4E-12	-3.3E-09
Max	219.2E-12	4.0E-09
Average	46.2E-12	495.1E-12
Sigma	99.5E-12	2.4E-09

Drift Calculation

IIO4DUTC	0 p/cm ²	2E+11 p/cm ²
OFF samples		
27	-	4.04E-09
28	-	-1.12E-09
29	-	2.75E-09
30	-	549.72E-12
32	-	-278.84E-12
39	-	-3.24E-09
Average	-	448.89E-12
Sigma	-	2.41E-09

Test conditions : Protons

Parameter : Input Offset Current : IIO4DUTD

+VCC=2.5V. -VCC=-2.5V. VCM=-1.1V

Unit : A

Spec Limit Min : -10.0E-09

Spec Limit Max : 10.0E-09

Spec limits are represented in bold lines on the graphic.

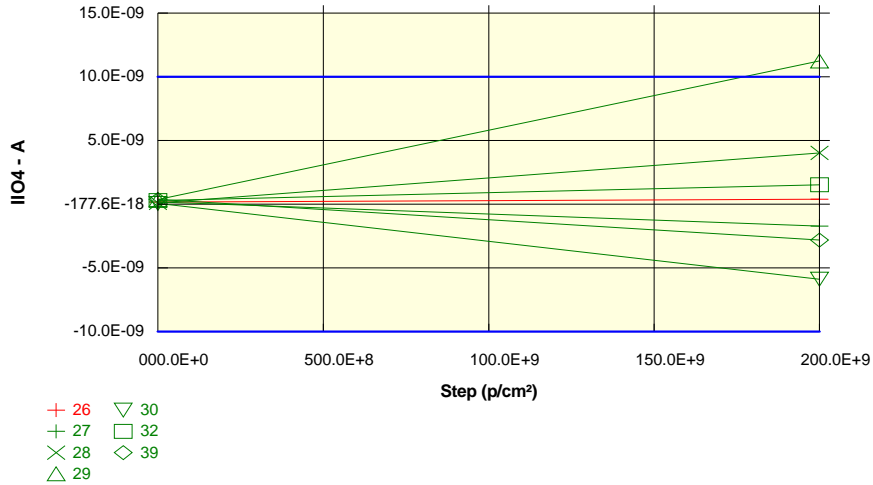

Measurements		
IIO4DUTD	0 p/cm ²	2E+11 p/cm ²
26_REF	154.2E-12	391.1E-12
OFF samples		
27	180.4E-12	-1.7E-09
28	106.4E-12	4.0E-09
29	362.6E-12	11.2E-09
30	64.6E-12	-5.9E-09
32	288.4E-12	1.5E-09
39	369.0E-12	-2.8E-09
Statistics		
Min	64.6E-12	-5.9E-09
Max	369.0E-12	11.2E-09
Average	228.6E-12	1.1E-09
Sigma	119.3E-12	5.5E-09

Drift Calculation		
IIO4DUTD	0 p/cm ²	2E+11 p/cm ²
OFF samples		
27	-	-1.90E-09
28	-	3.92E-09
29	-	10.87E-09
30	-	-5.95E-09
32	-	1.23E-09
39	-	-3.18E-09
Average	-	832.03E-12
Sigma	-	5.48E-09

Test conditions : Protons

Parameter : Input Bias Current : IIBP1DUTA

+VCC=30V, -VCC=GND, VCM=-15V

Unit : A

Spec Limit Min : -50.0E-09

Spec Limit Max : 100.0E-12

Spec limits are represented in bold lines on the graphic.

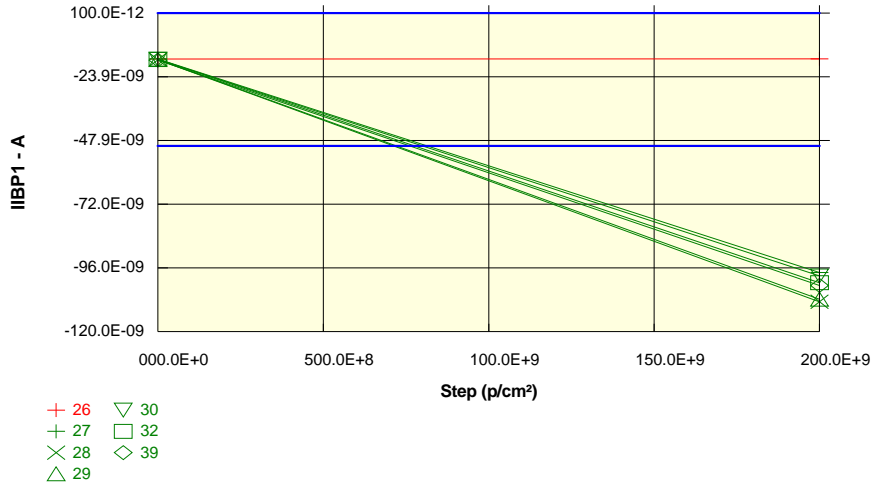

Measurements

IIBP1DUTA	0 p/cm ²	2E+11 p/cm ²
26_REF	-17.2E-09	-17.2E-09
OFF samples		
27	-17.2E-09	-97.7E-09
28	-17.5E-09	-108.7E-09
29	-17.4E-09	-107.7E-09
30	-17.3E-09	-99.0E-09
32	-17.3E-09	-101.6E-09
39	-17.6E-09	-102.6E-09
Statistics		
Min	-17.6E-09	-108.7E-09
Max	-17.2E-09	-97.7E-09
Average	-17.4E-09	-102.9E-09
Sigma	154.7E-12	4.1E-09

Drift Calculation

IIBP1DUTA	0 p/cm ²	2E+11 p/cm ²
OFF samples		
27	-	-80.53E-09
28	-	-91.21E-09
29	-	-90.32E-09
30	-	-81.69E-09
32	-	-84.29E-09
39	-	-84.96E-09
Average	-	-85.50E-09
Sigma	-	4.02E-09

Test conditions : Protons

Parameter : Input Bias Current : IIBP1DUTB

+VCC=30V, -VCC=GND, VCM=-15V

Unit : A

Spec Limit Min : -50.0E-09

Spec Limit Max : 100.0E-12

Spec limits are represented in bold lines on the graphic.

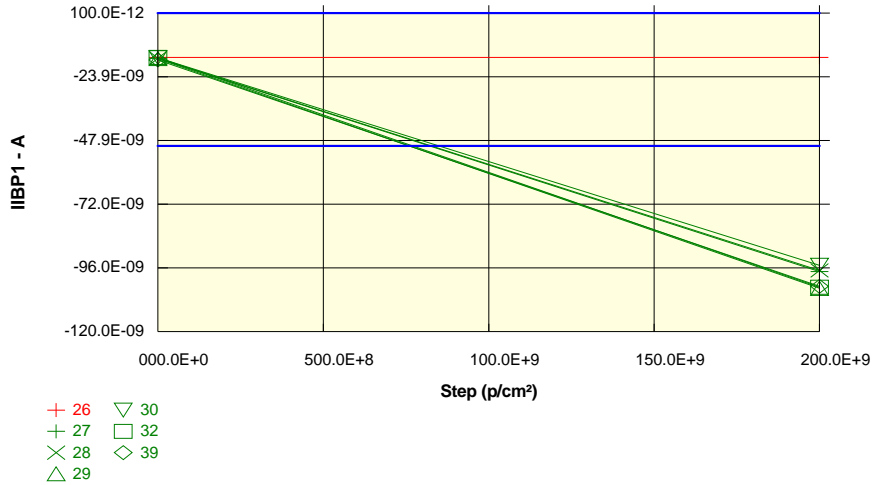

Measurements		
IIBP1DUTB	0 p/cm ²	2E+11 p/cm ²
26_REF	-16.6E-09	-16.6E-09
OFF samples		
27	-17.0E-09	-97.4E-09
28	-16.9E-09	-97.0E-09
29	-17.1E-09	-103.7E-09
30	-16.7E-09	-95.0E-09
32	-16.6E-09	-103.3E-09
39	-17.6E-09	-102.9E-09
Statistics		
Min	-17.6E-09	-103.7E-09
Max	-16.6E-09	-95.0E-09
Average	-17.0E-09	-99.9E-09
Sigma	308.1E-12	3.5E-09

Drift Calculation		
IIBP1DUTB	0 p/cm ²	2E+11 p/cm ²
OFF samples		
27	-	-80.35E-09
28	-	-80.05E-09
29	-	-86.59E-09
30	-	-78.28E-09
32	-	-86.63E-09
39	-	-85.34E-09
Average	-	-82.87E-09
Sigma	-	3.40E-09

Test conditions : Protons

Parameter : Input Bias Current : IIBP1DUTC

+VCC=30V, -VCC=GND, VCM=-15V

Unit : A

Spec Limit Min : -50.0E-09

Spec Limit Max : 100.0E-12

Spec limits are represented in bold lines on the graphic.

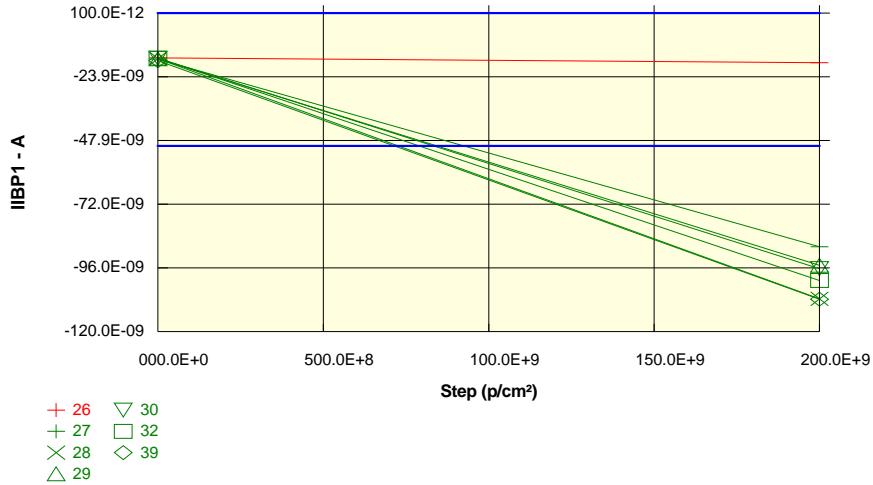

Measurements		
IIBP1DUTC	0 p/cm ²	2E+11 p/cm ²
26_REF	-16.8E-09	-18.6E-09
OFF samples		
27	-17.3E-09	-88.1E-09
28	-17.1E-09	-107.6E-09
29	-17.2E-09	-95.0E-09
30	-16.9E-09	-96.3E-09
32	-16.9E-09	-100.8E-09
39	-17.8E-09	-107.8E-09
Statistics		
Min	-17.8E-09	-107.8E-09
Max	-16.9E-09	-88.1E-09
Average	-17.2E-09	-99.2E-09
Sigma	302.9E-12	7.0E-09

Drift Calculation		
IIBP1DUTC	0 p/cm ²	2E+11 p/cm ²
OFF samples		
27	-	-70.74E-09
28	-	-90.54E-09
29	-	-77.86E-09
30	-	-79.33E-09
32	-	-83.86E-09
39	-	-89.96E-09
Average	-	-82.05E-09
Sigma	-	6.96E-09

Hirex Engineering	Protons Test Report		Ref.:	HRX/TID/0934
	LM124AJRQMLV	National Semiconductors	Issue:	01

Test conditions : Protons

Parameter : Input Bias Current : IIBP1DUTD

+VCC=30V, -VCC=GND, VCM=-15V

Unit : A

Spec Limit Min : -50.0E-09

Spec Limit Max : 100.0E-12

Spec limits are represented in bold lines on the graphic.

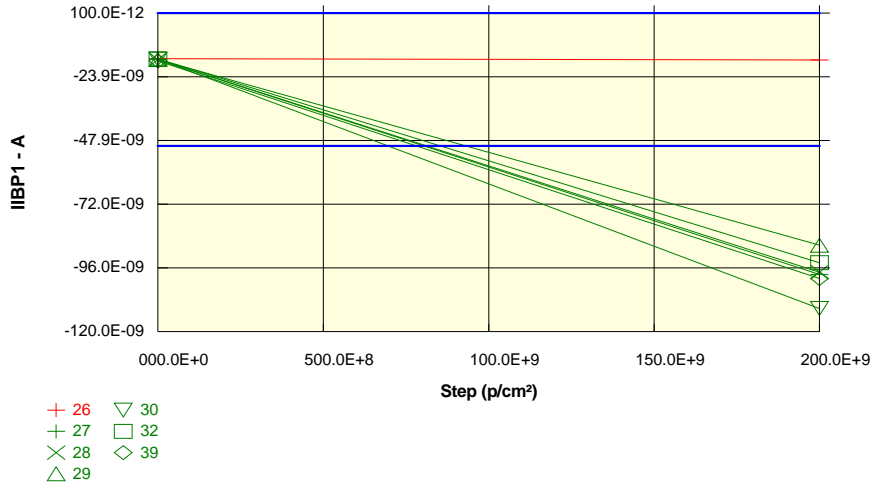

Measurements		
IIBP1DUTD	0 p/cm²	2E+11 p/cm²
26_REF	-17.1E-09	-17.6E-09
OFF samples		
27	-17.4E-09	-98.5E-09
28	-17.4E-09	-97.6E-09
29	-17.4E-09	-87.4E-09
30	-17.3E-09	-111.3E-09
32	-17.1E-09	-94.0E-09
39	-18.0E-09	-100.0E-09
Statistics		
Min	-18.0E-09	-111.3E-09
Max	-17.1E-09	-87.4E-09
Average	-17.4E-09	-98.1E-09
Sigma	265.1E-12	7.2E-09

Drift Calculation		
IIBP1DUTD	0 p/cm²	2E+11 p/cm²
OFF samples		
27	-	-81.08E-09
28	-	-80.19E-09
29	-	-69.98E-09
30	-	-94.05E-09
32	-	-76.89E-09
39	-	-81.99E-09
Average	-	-80.70E-09
Sigma	-	7.19E-09

Test conditions : Protons

Parameter : Input Bias Current : IIBP2DUTA

+VCC=2V. -VCC=-28V. VCM=13V

Unit : A

Spec Limit Min : -50.0E-09

Spec Limit Max : 100.0E-12

Spec limits are represented in bold lines on the graphic.

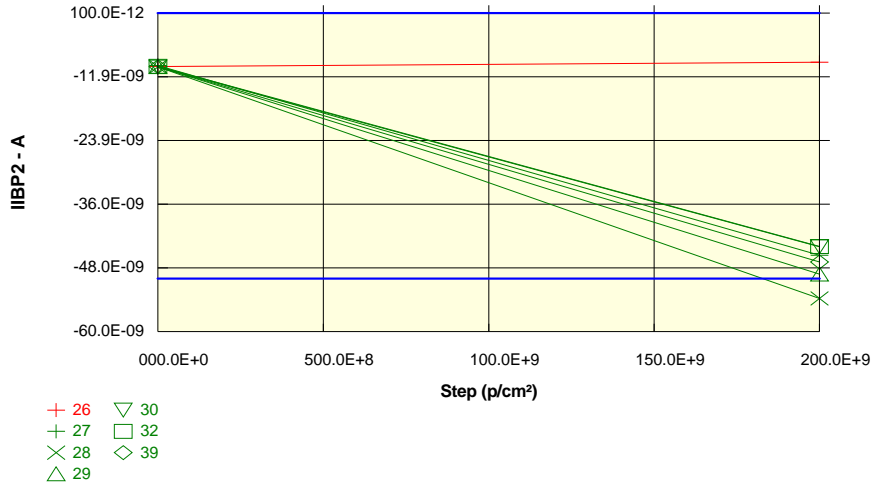

Measurements		
IIBP2DUTA	0 p/cm ²	2E+11 p/cm ²
26_REF	-10.0E-09	-9.2E-09
OFF samples		
27	-9.8E-09	-45.6E-09
28	-10.0E-09	-53.7E-09
29	-10.0E-09	-49.2E-09
30	-10.1E-09	-44.0E-09
32	-10.0E-09	-43.9E-09
39	-10.0E-09	-46.9E-09
Statistics		
Min	-10.1E-09	-53.7E-09
Max	-9.8E-09	-43.9E-09
Average	-10.0E-09	-47.2E-09
Sigma	90.2E-12	3.4E-09

Drift Calculation		
IIBP2DUTA	0 p/cm ²	2E+11 p/cm ²
OFF samples		
27	-	-35.79E-09
28	-	-43.70E-09
29	-	-39.16E-09
30	-	-33.92E-09
32	-	-33.97E-09
39	-	-36.86E-09
Average	-	-37.23E-09
Sigma	-	3.40E-09

Test conditions : Protons

Parameter : Input Bias Current : IIBP2DUTB

+VCC=2V. -VCC=-28V. VCM=13V

Unit : A

Spec Limit Min : -50.0E-09

Spec Limit Max : 100.0E-12

Spec limits are represented in bold lines on the graphic.

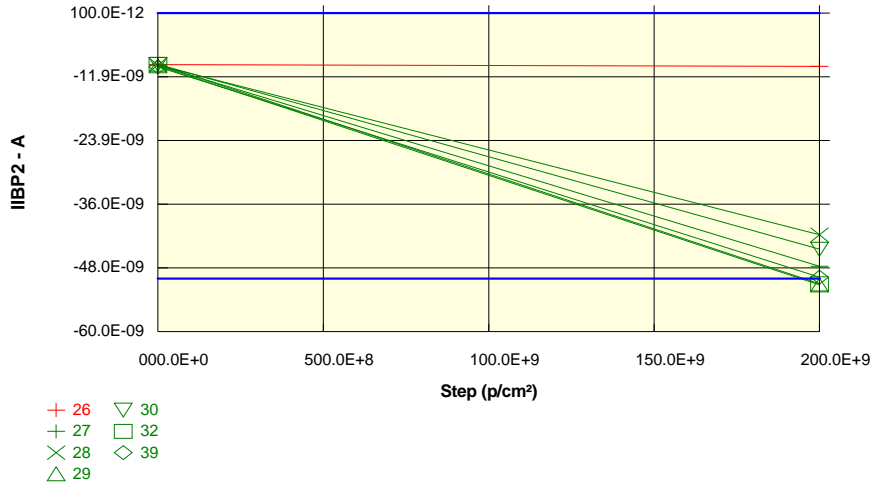

Measurements

IIBP2DUTB	0 p/cm²	2E+11 p/cm²
26_REF	-9.6E-09	-9.9E-09
OFF samples		
27	-9.7E-09	-47.7E-09
28	-9.7E-09	-41.7E-09
29	-9.8E-09	-51.2E-09
30	-9.6E-09	-44.4E-09
32	-9.6E-09	-51.0E-09
39	-10.0E-09	-49.7E-09
Statistics		
Min	-10.0E-09	-51.2E-09
Max	-9.6E-09	-41.7E-09
Average	-9.7E-09	-47.6E-09
Sigma	164.3E-12	3.5E-09

Drift Calculation

IIBP2DUTB	0 p/cm²	2E+11 p/cm²
OFF samples		
27	-	-37.93E-09
28	-	-32.03E-09
29	-	-41.34E-09
30	-	-34.89E-09
32	-	-41.42E-09
39	-	-39.69E-09
Average	-	-37.88E-09
Sigma	-	3.44E-09

Test conditions : Protons

Parameter : Input Bias Current : IIBP2DUTC

+VCC=2V. -VCC=-28V. VCM=13V

Unit : A

Spec Limit Min : -50.0E-09

Spec Limit Max : 100.0E-12

Spec limits are represented in bold lines on the graphic.

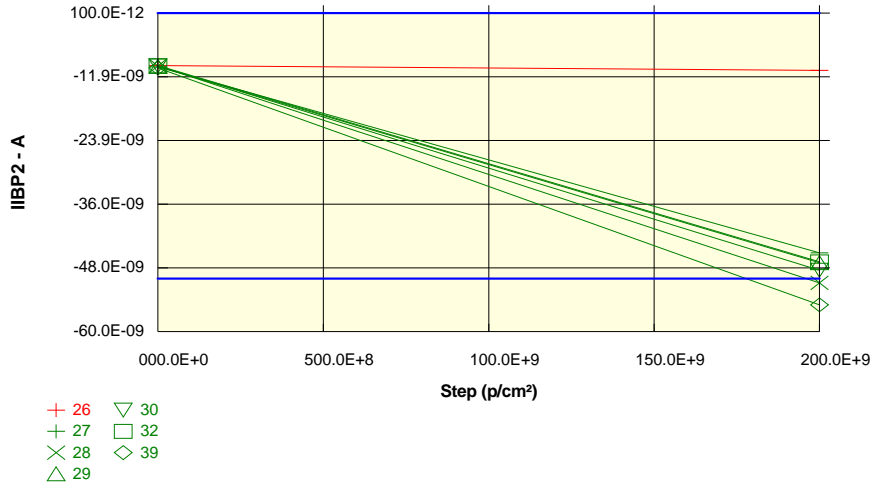

Measurements

IIBP2DUTC	0 p/cm²	2E+11 p/cm²
26_REF	-9.8E-09	-10.7E-09
OFF samples		
27	-10.0E-09	-45.1E-09
28	-9.9E-09	-50.8E-09
29	-10.0E-09	-47.0E-09
30	-9.9E-09	-48.4E-09
32	-9.8E-09	-46.8E-09
39	-10.3E-09	-54.9E-09
Statistics		
Min	-10.3E-09	-54.9E-09
Max	-9.8E-09	-45.1E-09
Average	-10.0E-09	-48.9E-09
Sigma	143.0E-12	3.2E-09

Drift Calculation

IIBP2DUTC	0 p/cm²	2E+11 p/cm²
OFF samples		
27	-	-35.10E-09
28	-	-40.93E-09
29	-	-37.06E-09
30	-	-38.56E-09
32	-	-37.02E-09
39	-	-44.69E-09
Average	-	-38.89E-09
Sigma	-	3.14E-09

Test conditions : Protons

Parameter : Input Bias Current : IIBP2DUTD

+VCC=2V. -VCC=-28V. VCM=13V

Unit : A

Spec Limit Min : -50.0E-09

Spec Limit Max : 100.0E-12

Spec limits are represented in bold lines on the graphic.

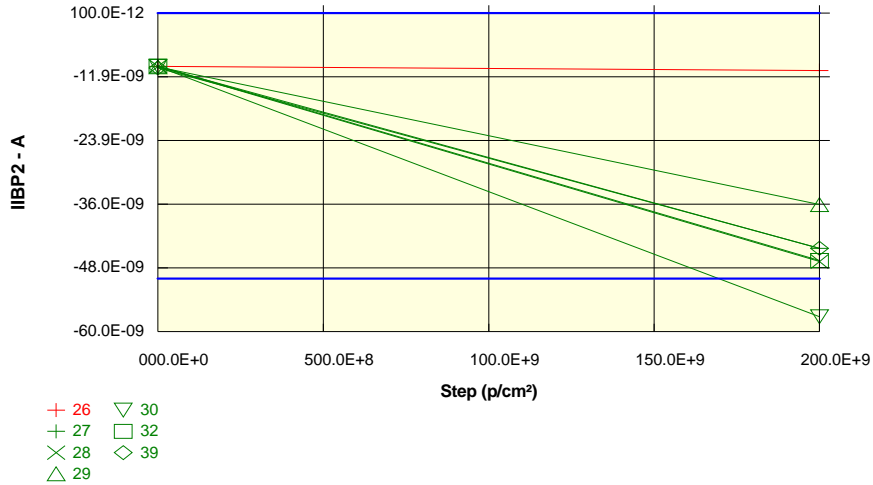

Measurements

IIBP2DUTD	0 p/cm²	2E+11 p/cm²
26_REF	-10.0E-09	-10.7E-09
OFF samples		
27	-10.0E-09	-44.3E-09
28	-10.0E-09	-46.8E-09
29	-10.0E-09	-36.0E-09
30	-10.0E-09	-57.2E-09
32	-9.9E-09	-46.6E-09
39	-10.3E-09	-44.3E-09
Statistics		
Min	-10.3E-09	-57.2E-09
Max	-9.9E-09	-36.0E-09
Average	-10.0E-09	-45.9E-09
Sigma	118.5E-12	6.2E-09

Drift Calculation

IIBP2DUTD	0 p/cm²	2E+11 p/cm²
OFF samples		
27	-	-34.27E-09
28	-	-36.79E-09
29	-	-26.00E-09
30	-	-47.22E-09
32	-	-36.71E-09
39	-	-34.02E-09
Average	-	-35.83E-09
Sigma	-	6.24E-09

Test conditions : Protons

Parameter : Input Bias Current : IIBP3DUTA

+VCC=5V. -VCC=GND.VCM=-1.4V

Unit : A

Spec Limit Min : -50.0E-09

Spec Limit Max : 100.0E-12

Spec limits are represented in bold lines on the graphic.

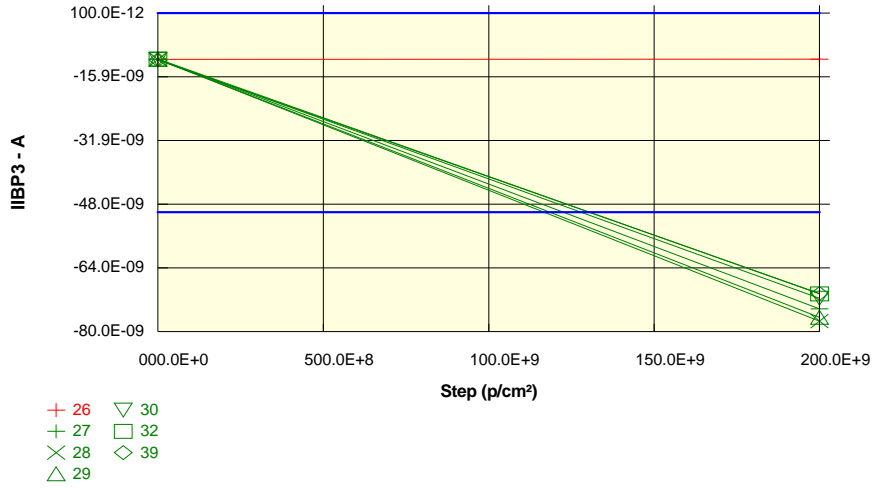

Measurements

IIBP3DUTA	0 p/cm ²	2E+11 p/cm ²
26_REF	-11.6E-09	-11.5E-09
OFF samples		
27	-11.5E-09	-74.3E-09
28	-11.5E-09	-77.4E-09
29	-11.5E-09	-76.4E-09
30	-11.6E-09	-71.6E-09
32	-11.5E-09	-70.5E-09
39	-11.7E-09	-70.4E-09
Statistics		
Min	-11.7E-09	-77.4E-09
Max	-11.5E-09	-70.4E-09
Average	-11.6E-09	-73.4E-09
Sigma	79.9E-12	2.8E-09

Drift Calculation

IIBP3DUTA	0 p/cm ²	2E+11 p/cm ²
OFF samples		
27	-	-62.79E-09
28	-	-65.84E-09
29	-	-64.84E-09
30	-	-60.01E-09
32	-	-59.06E-09
39	-	-58.72E-09
Average	-	-61.88E-09
Sigma	-	2.79E-09

Test conditions : Protons

Parameter : Input Bias Current : IIBP3DUTB

+VCC=5V. -VCC=GND.VCM=-1.4V

Unit : A

Spec Limit Min : -50.0E-09

Spec Limit Max : 100.0E-12

Spec limits are represented in bold lines on the graphic.

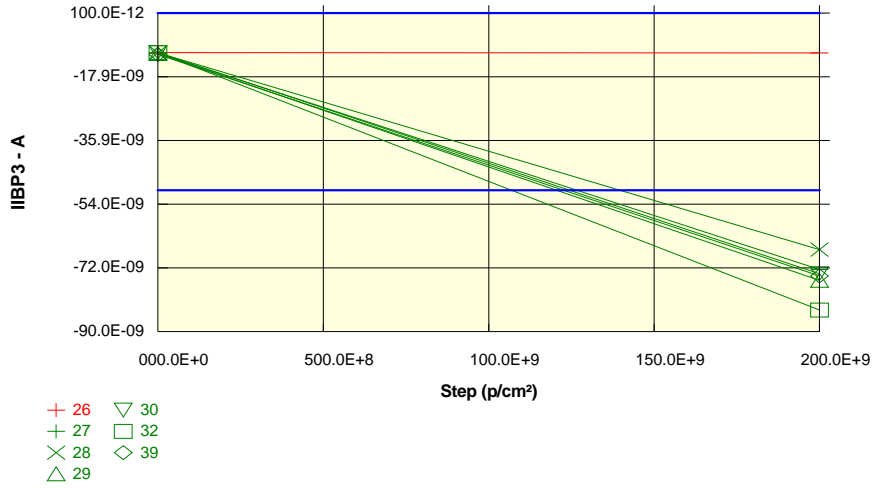

Measurements

IIBP3DUTB	0 p/cm ²	2E+11 p/cm ²
26_REF	-11.1E-09	-11.2E-09
OFF samples		
27	-11.3E-09	-72.4E-09
28	-11.2E-09	-66.8E-09
29	-11.3E-09	-75.5E-09
30	-11.1E-09	-73.6E-09
32	-11.1E-09	-83.9E-09
39	-11.6E-09	-74.3E-09
Statistics		
Min	-11.6E-09	-83.9E-09
Max	-11.1E-09	-66.8E-09
Average	-11.3E-09	-74.4E-09
Sigma	173.3E-12	5.1E-09

Drift Calculation

IIBP3DUTB	0 p/cm ²	2E+11 p/cm ²
OFF samples		
27	-	-61.12E-09
28	-	-55.62E-09
29	-	-64.19E-09
30	-	-62.54E-09
32	-	-72.77E-09
39	-	-62.66E-09
Average	-	-63.15E-09
Sigma	-	5.08E-09

Test conditions : Protons

Parameter : Input Bias Current : IIBP3DUTC

+VCC=5V. -VCC=GND.VCM=-1.4V

Unit : A

Spec Limit Min : -50.0E-09

Spec Limit Max : 100.0E-12

Spec limits are represented in bold lines on the graphic.

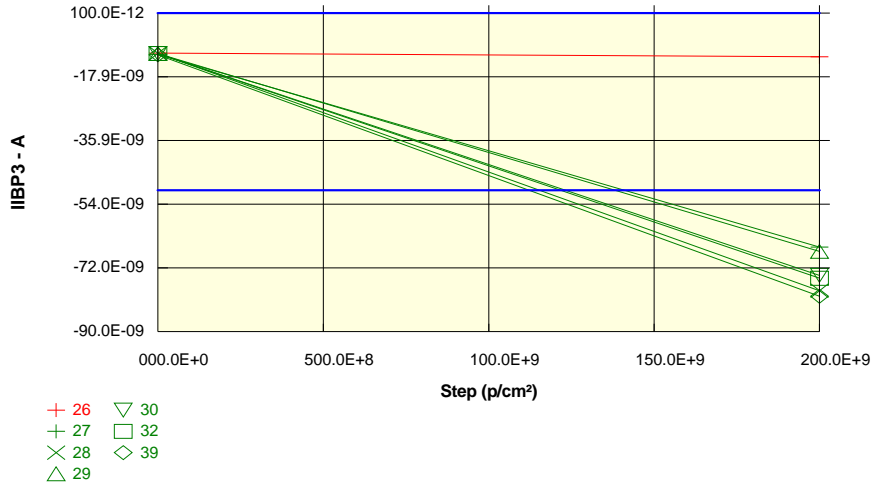

Measurements		
IIBP3DUTC	0 p/cm²	2E+11 p/cm²
26_REF	-11.2E-09	-12.3E-09
OFF samples		
27	-11.6E-09	-66.1E-09
28	-11.3E-09	-78.5E-09
29	-11.3E-09	-67.3E-09
30	-11.3E-09	-74.1E-09
32	-11.4E-09	-74.9E-09
39	-11.7E-09	-80.0E-09
Statistics		
Min	-11.7E-09	-80.0E-09
Max	-11.3E-09	-66.1E-09
Average	-11.4E-09	-73.5E-09
Sigma	143.8E-12	5.2E-09

Drift Calculation		
IIBP3DUTC	0 p/cm²	2E+11 p/cm²
OFF samples		
27	-	-54.48E-09
28	-	-67.15E-09
29	-	-55.99E-09
30	-	-62.73E-09
32	-	-63.55E-09
39	-	-68.32E-09
Average	-	-62.04E-09
Sigma	-	5.20E-09

Test conditions : Protons

Parameter : Input Bias Current : IIBP3DUTD

+VCC=5V. -VCC=GND.VCM=-1.4V

Unit : A

Spec Limit Min : -50.0E-09

Spec Limit Max : 100.0E-12

Spec limits are represented in bold lines on the graphic.

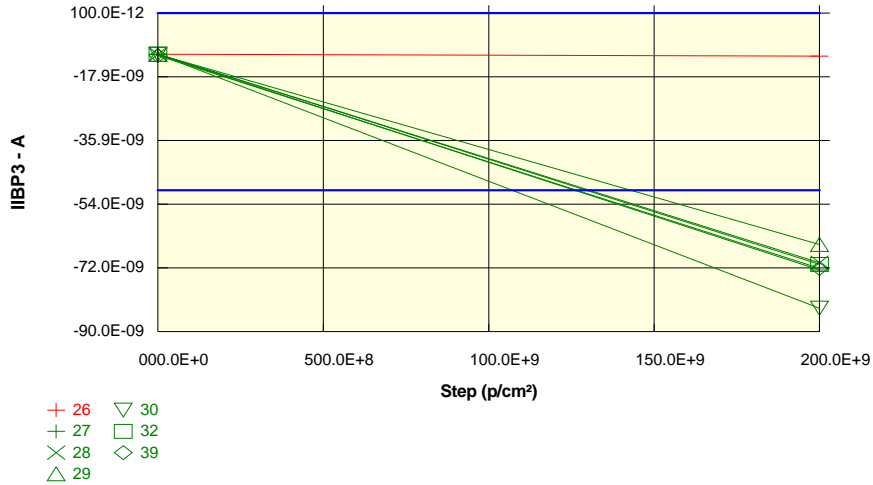

Measurements

IIBP3DUTD	0 p/cm²	2E+11 p/cm²
26_REF	-11.6E-09	-12.1E-09
OFF samples		
27	-11.6E-09	-72.5E-09
28	-11.5E-09	-70.5E-09
29	-11.6E-09	-65.3E-09
30	-11.6E-09	-83.4E-09
32	-11.5E-09	-71.0E-09
39	-11.9E-09	-72.1E-09
Statistics		
Min	-11.9E-09	-83.4E-09
Max	-11.5E-09	-65.3E-09
Average	-11.6E-09	-72.5E-09
Sigma	122.7E-12	5.4E-09

Drift Calculation

IIBP3DUTD	0 p/cm²	2E+11 p/cm²
OFF samples		
27	-	-60.89E-09
28	-	-58.99E-09
29	-	-53.72E-09
30	-	-71.83E-09
32	-	-59.46E-09
39	-	-60.22E-09
Average	-	-60.85E-09
Sigma	-	5.43E-09

Test conditions : Protons

Parameter : Input Bias Current : IIBP4DUTA

+VCC=2.5V. -VCC=-2.5V. VCM=-1.1V

Unit : A

Spec Limit Min : -50.0E-09

Spec Limit Max : 100.0E-12

Spec limits are represented in bold lines on the graphic.

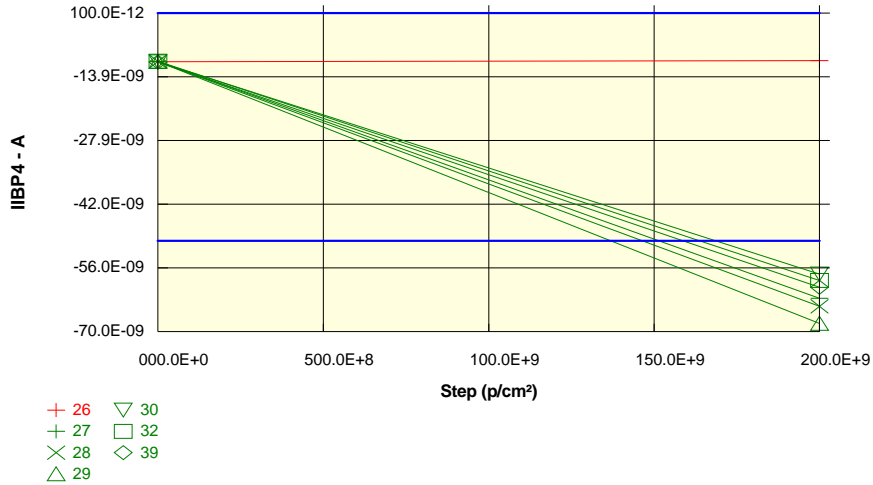

Measurements

IIBP4DUTA	0 p/cm ²	2E+11 p/cm ²
26_REF	-10.6E-09	-10.4E-09
OFF samples		
27	-10.5E-09	-62.7E-09
28	-10.6E-09	-64.4E-09
29	-10.6E-09	-68.2E-09
30	-10.6E-09	-57.4E-09
32	-10.5E-09	-58.8E-09
39	-10.7E-09	-60.2E-09
Statistics		
Min	-10.7E-09	-68.2E-09
Max	-10.5E-09	-57.4E-09
Average	-10.6E-09	-61.9E-09
Sigma	60.4E-12	3.6E-09

Drift Calculation

IIBP4DUTA	0 p/cm ²	2E+11 p/cm ²
OFF samples		
27	-	-52.13E-09
28	-	-53.88E-09
29	-	-57.61E-09
30	-	-46.74E-09
32	-	-48.26E-09
39	-	-49.56E-09
Average	-	-51.36E-09
Sigma	-	3.66E-09

Test conditions : Protons

Parameter : Input Bias Current : IIBP4DUTB

+VCC=2.5V. -VCC=-2.5V. VCM=-1.1V

Unit : A

Spec Limit Min : -50.0E-09

Spec Limit Max : 100.0E-12

Spec limits are represented in bold lines on the graphic.

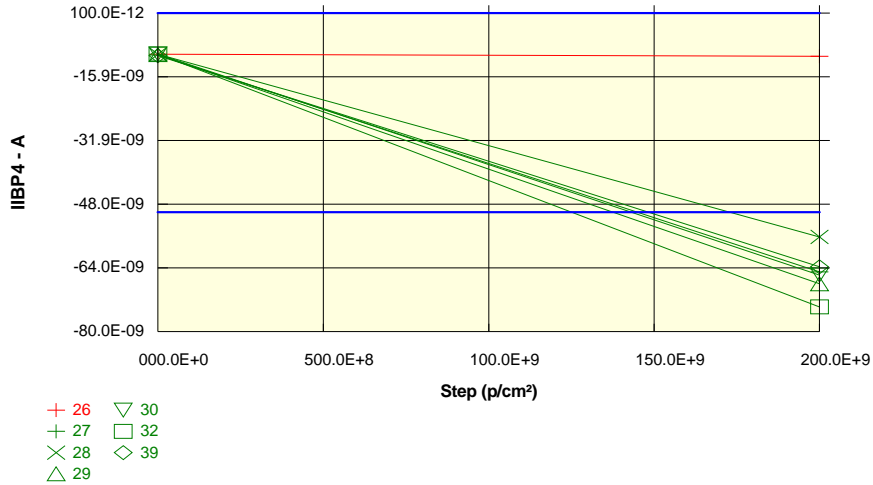

Measurements

IIBP4DUTB	0 p/cm ²	2E+11 p/cm ²
26_REF	-10.3E-09	-10.7E-09
OFF samples		
27	-10.4E-09	-65.0E-09
28	-10.3E-09	-56.2E-09
29	-10.4E-09	-68.0E-09
30	-10.2E-09	-65.8E-09
32	-10.2E-09	-73.8E-09
39	-10.6E-09	-63.7E-09
Statistics		
Min	-10.6E-09	-73.8E-09
Max	-10.2E-09	-56.2E-09
Average	-10.4E-09	-65.4E-09
Sigma	143.5E-12	5.2E-09

Drift Calculation

IIBP4DUTB	0 p/cm ²	2E+11 p/cm ²
OFF samples		
27	-	-54.57E-09
28	-	-45.93E-09
29	-	-57.61E-09
30	-	-55.56E-09
32	-	-63.55E-09
39	-	-53.10E-09
Average	-	-55.05E-09
Sigma	-	5.27E-09

Test conditions : Protons

Parameter : Input Bias Current : IIBP4DUTC

+VCC=2.5V. -VCC=-2.5V. VCM=-1.1V

Unit : A

Spec Limit Min : -50.0E-09

Spec Limit Max : 100.0E-12

Spec limits are represented in bold lines on the graphic.

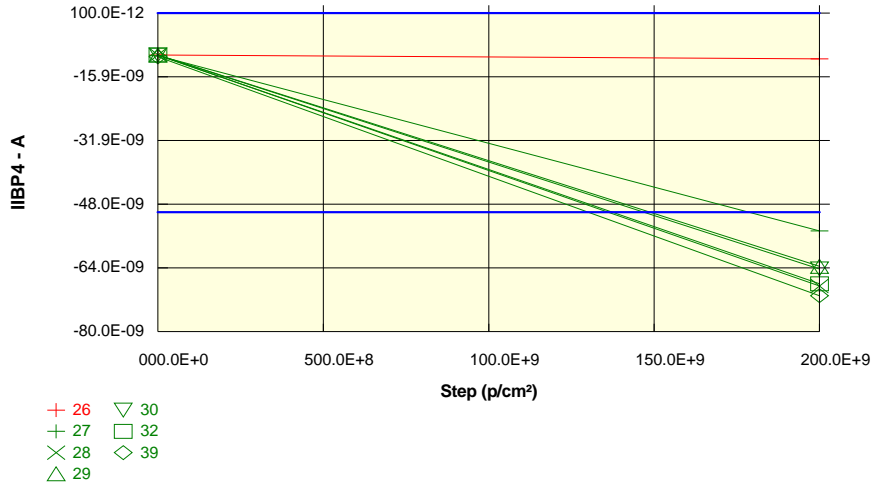

Measurements

IIBP4DUTC	0 p/cm ²	2E+11 p/cm ²
26_REF	-10.4E-09	-11.4E-09
OFF samples		
27	-10.6E-09	-54.7E-09
28	-10.4E-09	-68.6E-09
29	-10.5E-09	-63.6E-09
30	-10.4E-09	-64.3E-09
32	-10.5E-09	-68.0E-09
39	-10.9E-09	-71.0E-09
Statistics		
Min	-10.9E-09	-71.0E-09
Max	-10.4E-09	-54.7E-09
Average	-10.5E-09	-65.0E-09
Sigma	166.7E-12	5.3E-09

Drift Calculation

IIBP4DUTC	0 p/cm ²	2E+11 p/cm ²
OFF samples		
27	-	-44.06E-09
28	-	-58.13E-09
29	-	-53.13E-09
30	-	-53.84E-09
32	-	-57.54E-09
39	-	-60.08E-09
Average	-	-54.46E-09
Sigma	-	5.24E-09

Test conditions : Protons

Parameter : Input Bias Current : IIBP4DUTD

+VCC=2.5V. -VCC=-2.5V. VCM=-1.1V

Unit : A

Spec Limit Min : -50.0E-09

Spec Limit Max : 100.0E-12

Spec limits are represented in bold lines on the graphic.

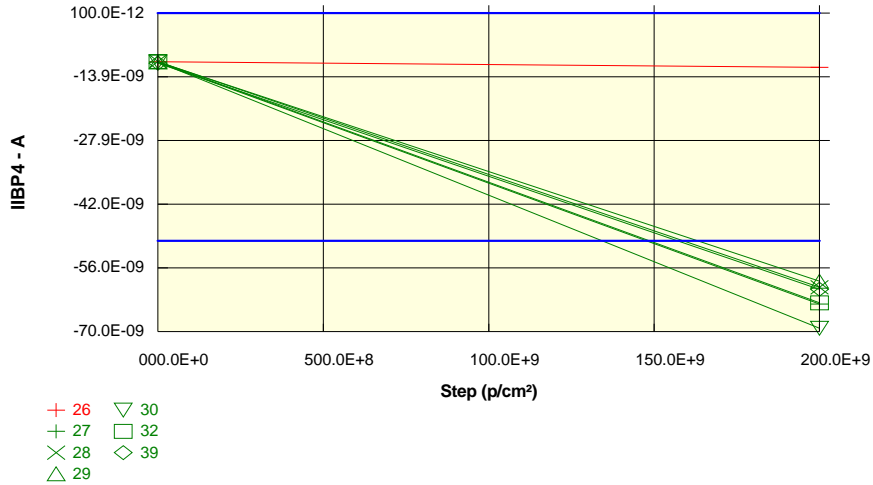

Measurements		
IIBP4DUTD	0 p/cm²	2E+11 p/cm²
26_REF	-10.6E-09	-11.9E-09
OFF samples		
27	-10.7E-09	-63.9E-09
28	-10.6E-09	-60.2E-09
29	-10.7E-09	-58.9E-09
30	-10.7E-09	-69.3E-09
32	-10.6E-09	-63.7E-09
39	-10.9E-09	-60.7E-09
Statistics		
Min	-10.9E-09	-69.3E-09
Max	-10.6E-09	-58.9E-09
Average	-10.7E-09	-62.8E-09
Sigma	126.4E-12	3.4E-09

Drift Calculation		
IIBP4DUTD	0 p/cm²	2E+11 p/cm²
OFF samples		
27	-	-53.21E-09
28	-	-49.69E-09
29	-	-48.25E-09
30	-	-58.60E-09
32	-	-53.11E-09
39	-	-49.76E-09
Average	-	-52.10E-09
Sigma	-	3.43E-09

Hirex Engineering	Protons Test Report		Ref.:	HRX/TID/0934
	LM124AJRQLV	National Semiconductors	Issue:	01

Test conditions : Protons

Parameter : Input Bias Current : IIBM1DUTA

+VCC=30V. -VCC=GND.VCM=-15V

Unit : A

Spec Limit Min : -50.0E-09

Spec Limit Max : 100.0E-12

Spec limits are represented in bold lines on the graphic.

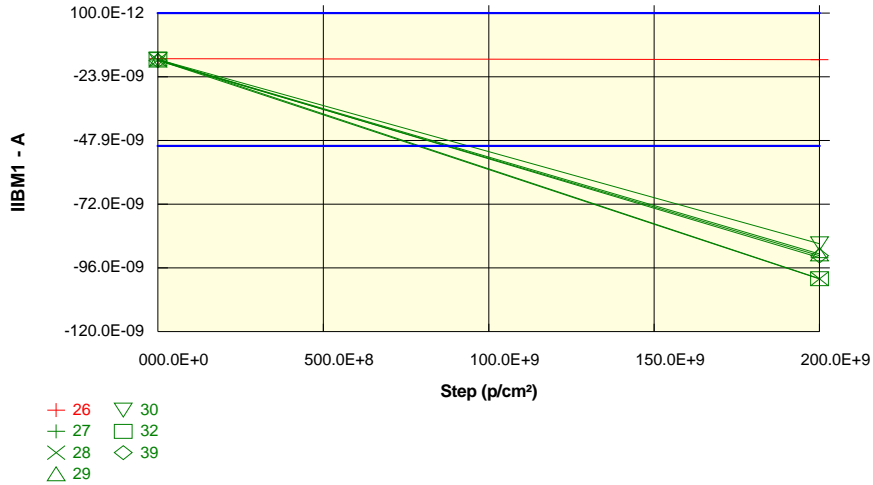

Measurements

IIBM1DUTA	0 p/cm²	2E+11 p/cm²
26_REF	-17.1E-09	-17.5E-09
OFF samples		
27	-17.6E-09	-92.1E-09
28	-17.6E-09	-100.1E-09
29	-17.6E-09	-90.7E-09
30	-17.4E-09	-86.8E-09
32	-17.2E-09	-100.1E-09
39	-17.8E-09	-91.5E-09
Statistics		
Min	-17.8E-09	-100.1E-09
Max	-17.2E-09	-86.8E-09
Average	-17.5E-09	-93.6E-09
Sigma	187.2E-12	4.9E-09

Drift Calculation

IIBM1DUTA	0 p/cm²	2E+11 p/cm²
OFF samples		
27	-	-74.53E-09
28	-	-82.50E-09
29	-	-73.13E-09
30	-	-69.44E-09
32	-	-82.84E-09
39	-	-73.64E-09
Average	-	-76.01E-09
Sigma	-	4.96E-09

Test conditions : Protons

Parameter : Input Bias Current : IIBM1DUTB

+VCC=30V, -VCC=GND, VCM=-15V

Unit : A

Spec Limit Min : -50.0E-09

Spec Limit Max : 100.0E-12

Spec limits are represented in bold lines on the graphic.

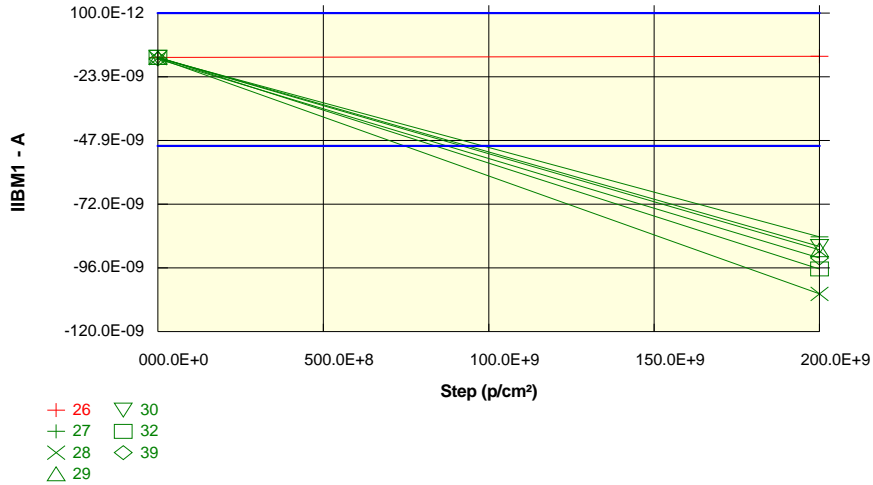

Measurements

IIBM1DUTB	0 p/cm ²	2E+11 p/cm ²
26_REF	-16.6E-09	-16.2E-09
OFF samples		
27	-16.9E-09	-84.2E-09
28	-16.9E-09	-105.8E-09
29	-16.7E-09	-89.1E-09
30	-16.6E-09	-87.9E-09
32	-16.5E-09	-96.4E-09
39	-17.2E-09	-92.3E-09
Statistics		
Min	-17.2E-09	-105.8E-09
Max	-16.5E-09	-84.2E-09
Average	-16.8E-09	-92.6E-09
Sigma	236.1E-12	7.0E-09

Drift Calculation

IIBM1DUTB	0 p/cm ²	2E+11 p/cm ²
OFF samples		
27	-	-67.36E-09
28	-	-88.89E-09
29	-	-72.42E-09
30	-	-71.34E-09
32	-	-79.87E-09
39	-	-75.03E-09
Average	-	-75.82E-09
Sigma	-	6.97E-09

Test conditions : Protons

Parameter : Input Bias Current : IIBM1DUTC

+VCC=30V. -VCC=GND.VCM=-15V

Unit : A

Spec Limit Min : -50.0E-09

Spec Limit Max : 100.0E-12

Spec limits are represented in bold lines on the graphic.

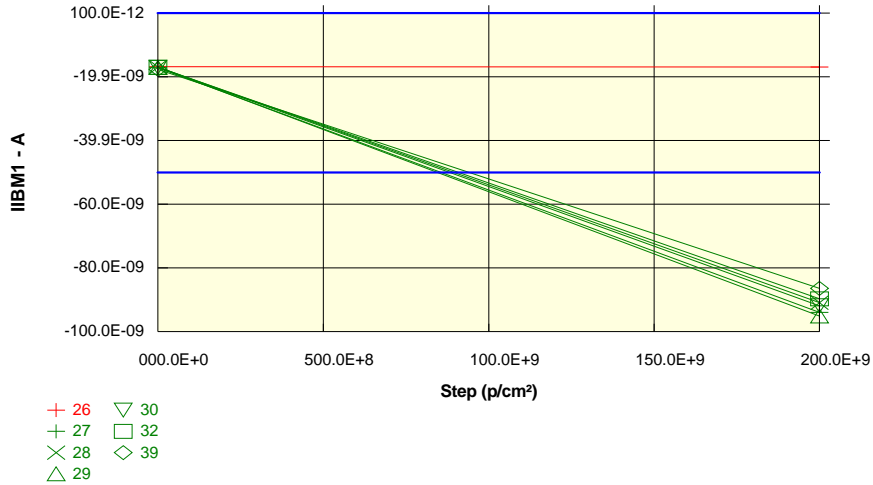

Measurements

IIBM1DUTC	0 p/cm ²	2E+11 p/cm ²
26_REF	-16.7E-09	-16.9E-09
OFF samples		
27	-17.0E-09	-93.9E-09
28	-16.9E-09	-90.9E-09
29	-17.0E-09	-95.1E-09
30	-16.9E-09	-91.9E-09
32	-16.9E-09	-89.7E-09
39	-17.6E-09	-86.4E-09
Statistics		
Min	-17.6E-09	-95.1E-09
Max	-16.9E-09	-86.4E-09
Average	-17.1E-09	-91.3E-09
Sigma	255.6E-12	2.8E-09

Drift Calculation

IIBM1DUTC	0 p/cm ²	2E+11 p/cm ²
OFF samples		
27	-	-76.90E-09
28	-	-74.07E-09
29	-	-78.13E-09
30	-	-74.98E-09
32	-	-72.78E-09
39	-	-68.82E-09
Average	-	-74.28E-09
Sigma	-	3.01E-09

Test conditions : Protons

Parameter : Input Bias Current : IIBM1DUTD

+VCC=30V, -VCC=GND, VCM=-15V

Unit : A

Spec Limit Min : -50.0E-09

Spec Limit Max : 100.0E-12

Spec limits are represented in bold lines on the graphic.

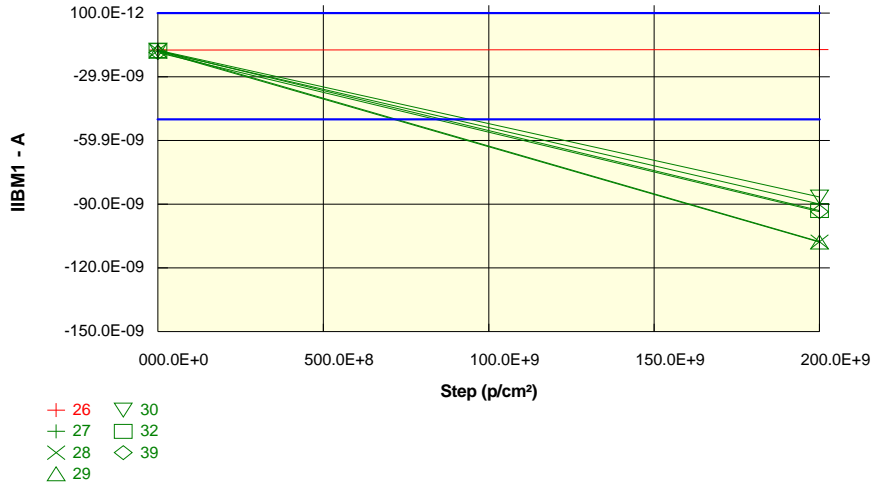

Measurements

IIBM1DUTD	0 p/cm²	2E+11 p/cm²
26_REF	-17.3E-09	-17.1E-09
OFF samples		
27	-17.7E-09	-89.8E-09
28	-17.5E-09	-107.7E-09
29	-17.9E-09	-107.8E-09
30	-17.4E-09	-86.6E-09
32	-17.5E-09	-93.0E-09
39	-18.5E-09	-93.5E-09
Statistics		
Min	-18.5E-09	-107.8E-09
Max	-17.4E-09	-86.6E-09
Average	-17.8E-09	-96.4E-09
Sigma	383.2E-12	8.3E-09

Drift Calculation

IIBM1DUTD	0 p/cm²	2E+11 p/cm²
OFF samples		
27	-	-72.10E-09
28	-	-90.19E-09
29	-	-89.89E-09
30	-	-69.20E-09
32	-	-75.43E-09
39	-	-74.99E-09
Average	-	-78.63E-09
Sigma	-	8.32E-09

Test conditions : Protons

Parameter : Input Bias Current : IIBM2DUTA

+VCC=2V. -VCC=-28V. VCM=13V

Unit : A

Spec Limit Min : -50.0E-09

Spec Limit Max : 100.0E-12

Spec limits are represented in bold lines on the graphic.

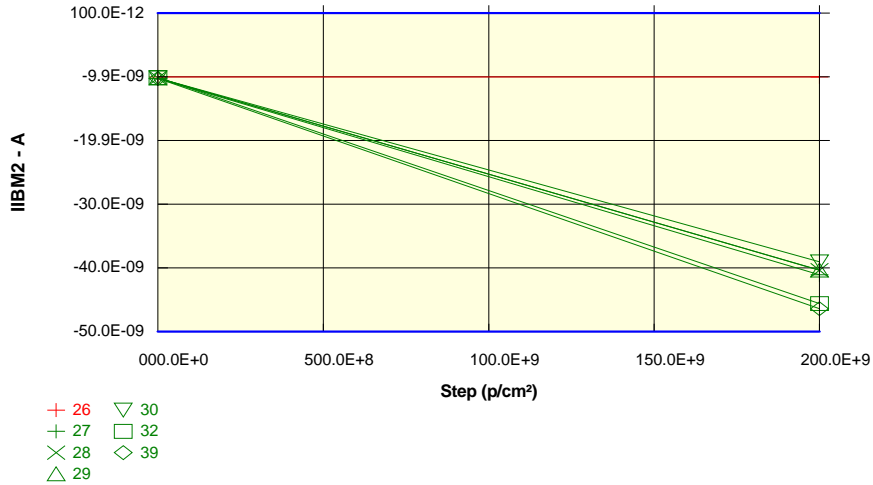

Measurements

IIBM2DUTA	0 p/cm²	2E+11 p/cm²
26_REF	-10.0E-09	-9.9E-09
OFF samples		
27	-10.2E-09	-41.1E-09
28	-10.1E-09	-40.4E-09
29	-10.1E-09	-40.3E-09
30	-10.1E-09	-39.0E-09
32	-10.0E-09	-45.6E-09
39	-10.2E-09	-46.4E-09
Statistics		
Min	-10.2E-09	-46.4E-09
Max	-10.0E-09	-39.0E-09
Average	-10.1E-09	-42.1E-09
Sigma	62.1E-12	2.8E-09

Drift Calculation

IIBM2DUTA	0 p/cm²	2E+11 p/cm²
OFF samples		
27	-	-30.87E-09
28	-	-30.23E-09
29	-	-30.19E-09
30	-	-28.91E-09
32	-	-35.57E-09
39	-	-36.22E-09
Average	-	-32.00E-09
Sigma	-	2.82E-09

Test conditions : Protons

Parameter : Input Bias Current : IIBM2DUTB

+VCC=2V. -VCC=-28V. VCM=13V

Unit : A

Spec Limit Min : -50.0E-09

Spec Limit Max : 100.0E-12

Spec limits are represented in bold lines on the graphic.

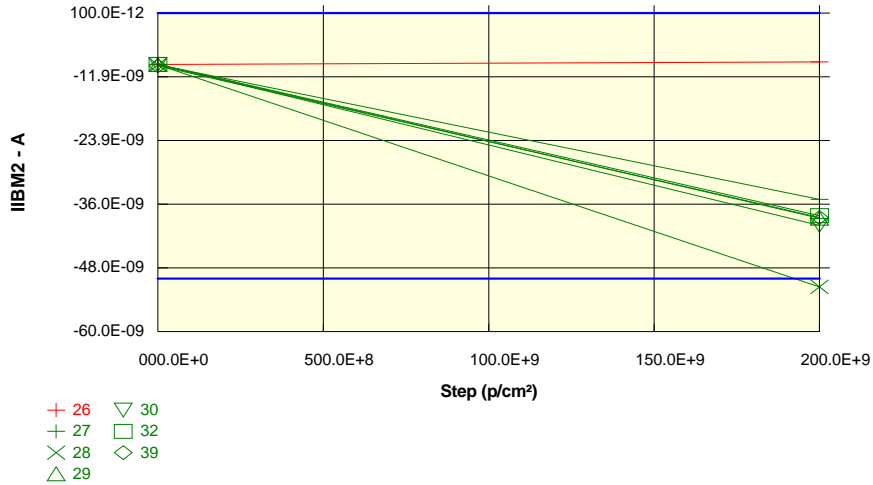

Measurements

IIBM2DUTB	0 p/cm²	2E+11 p/cm²
26_REF	-9.6E-09	-9.1E-09
OFF samples		
27	-9.7E-09	-35.1E-09
28	-9.7E-09	-51.6E-09
29	-9.6E-09	-38.6E-09
30	-9.6E-09	-40.0E-09
32	-9.6E-09	-38.1E-09
39	-9.8E-09	-38.5E-09
Statistics		
Min	-9.8E-09	-51.6E-09
Max	-9.6E-09	-35.1E-09
Average	-9.7E-09	-40.3E-09
Sigma	95.4E-12	5.2E-09

Drift Calculation

IIBM2DUTB	0 p/cm²	2E+11 p/cm²
OFF samples		
27	-	-25.41E-09
28	-	-41.88E-09
29	-	-29.04E-09
30	-	-30.35E-09
32	-	-28.58E-09
39	-	-28.64E-09
Average	-	-30.65E-09
Sigma	-	5.24E-09

Test conditions : Protons

Parameter : Input Bias Current : IIBM2DUTC

+VCC=2V. -VCC=-28V. VCM=13V

Unit : A

Spec Limit Min : -50.0E-09

Spec Limit Max : 100.0E-12

Spec limits are represented in bold lines on the graphic.

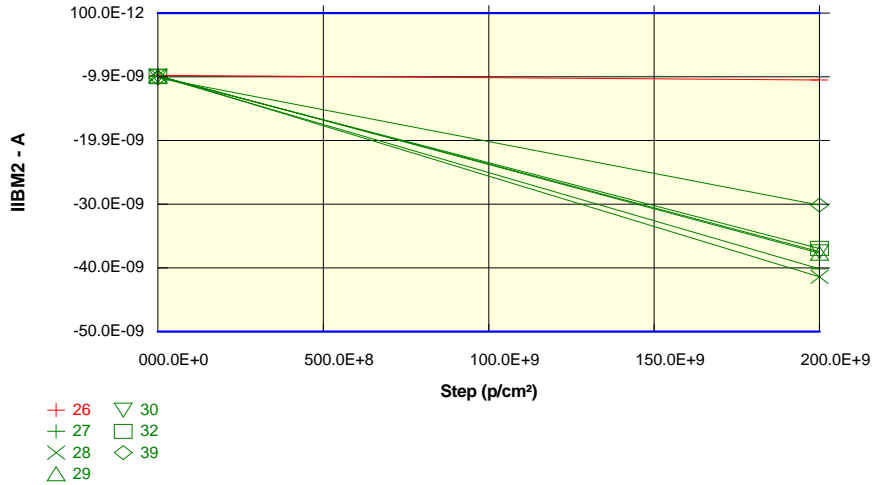

Measurements

IIBM2DUTC	0 p/cm ²	2E+11 p/cm ²
26_REF	-9.7E-09	-10.4E-09
OFF samples		
27	-9.9E-09	-40.1E-09
28	-9.7E-09	-41.4E-09
29	-9.8E-09	-37.7E-09
30	-9.8E-09	-37.4E-09
32	-9.9E-09	-36.9E-09
39	-10.1E-09	-30.1E-09
Statistics		
Min	-10.1E-09	-41.4E-09
Max	-9.7E-09	-30.1E-09
Average	-9.9E-09	-37.3E-09
Sigma	126.6E-12	3.6E-09

Drift Calculation

IIBM2DUTC	0 p/cm ²	2E+11 p/cm ²
OFF samples		
27	-	-30.26E-09
28	-	-31.70E-09
29	-	-27.92E-09
30	-	-27.63E-09
32	-	-27.00E-09
39	-	-20.02E-09
Average	-	-27.42E-09
Sigma	-	3.69E-09

Test conditions : Protons

Parameter : Input Bias Current : IIBM2DUTD

+VCC=2V. -VCC=-28V. VCM=13V

Unit : A

Spec Limit Min : -50.0E-09

Spec Limit Max : 100.0E-12

Spec limits are represented in bold lines on the graphic.

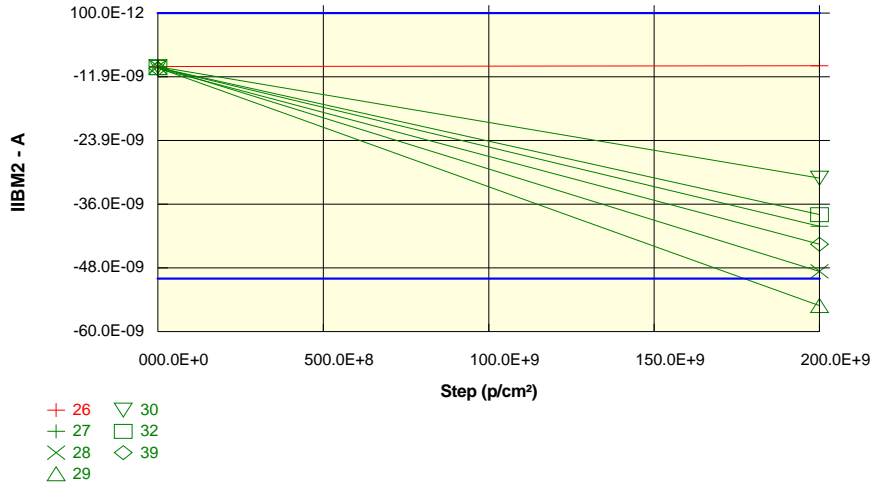

Measurements

IIBM2DUTD	0 p/cm²	2E+11 p/cm²
26_REF	-10.0E-09	-9.8E-09
OFF samples		
27	-10.2E-09	-40.1E-09
28	-10.0E-09	-48.6E-09
29	-10.2E-09	-55.1E-09
30	-10.0E-09	-31.0E-09
32	-10.2E-09	-37.9E-09
39	-10.4E-09	-43.5E-09
Statistics		
Min	-10.4E-09	-55.1E-09
Max	-10.0E-09	-31.0E-09
Average	-10.2E-09	-42.7E-09
Sigma	128.8E-12	7.7E-09

Drift Calculation

IIBM2DUTD	0 p/cm²	2E+11 p/cm²
OFF samples		
27	-	-29.96E-09
28	-	-38.62E-09
29	-	-44.86E-09
30	-	-21.03E-09
32	-	-27.75E-09
39	-	-33.15E-09
Average	-	-32.56E-09
Sigma	-	7.65E-09

Test conditions : Protons

Parameter : Input Bias Current : IIBM3DUTA

+VCC=5V. -VCC=GND. VCM=-1.4V

Unit : A

Spec Limit Min : -50.0E-09

Spec Limit Max : 100.0E-12

Spec limits are represented in bold lines on the graphic.

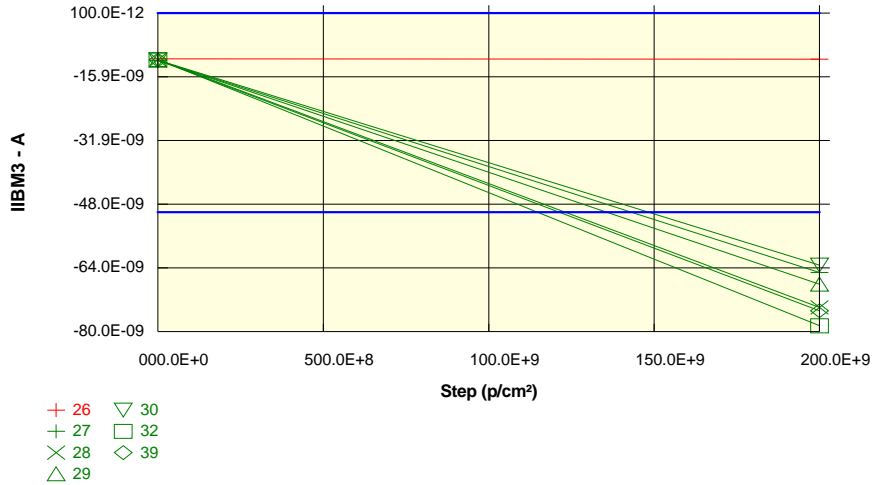

Measurements

IIBM3DUTA	0 p/cm²	2E+11 p/cm²
26_REF	-11.4E-09	-11.5E-09
OFF samples		
27	-11.8E-09	-65.1E-09
28	-11.6E-09	-73.9E-09
29	-11.8E-09	-68.1E-09
30	-11.7E-09	-63.3E-09
32	-11.6E-09	-78.5E-09
39	-11.7E-09	-74.8E-09
Statistics		
Min	-11.8E-09	-78.5E-09
Max	-11.6E-09	-63.3E-09
Average	-11.7E-09	-70.6E-09
Sigma	79.8E-12	5.5E-09

Drift Calculation

IIBM3DUTA	0 p/cm²	2E+11 p/cm²
OFF samples		
27	-	-53.29E-09
28	-	-62.30E-09
29	-	-56.29E-09
30	-	-51.59E-09
32	-	-66.95E-09
39	-	-63.02E-09
Average	-	-58.91E-09
Sigma	-	5.56E-09

Test conditions : Protons

Parameter : Input Bias Current : IIBM3DUTB

+VCC=5V. -VCC=GND. VCM=-1.4V

Unit : A

Spec Limit Min : -50.0E-09

Spec Limit Max : 100.0E-12

Spec limits are represented in bold lines on the graphic.

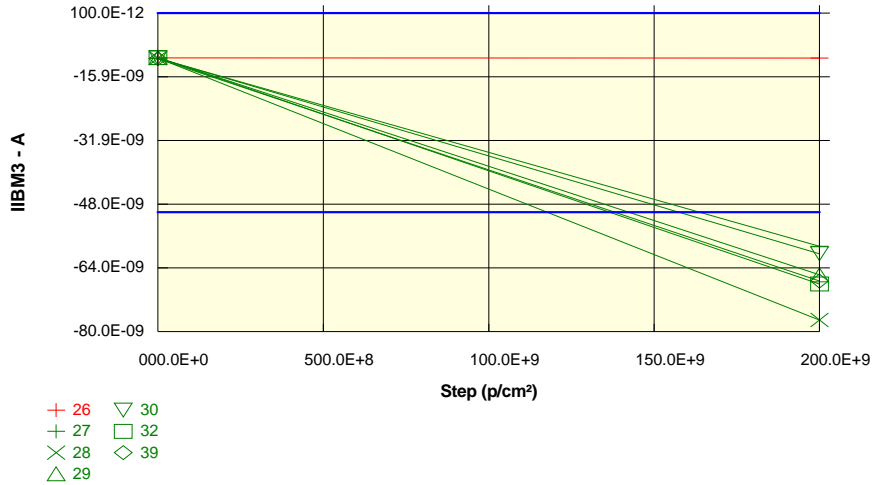

Measurements

IIBM3DUTB	0 p/cm²	2E+11 p/cm²
26_REF	-11.2E-09	-11.2E-09
OFF samples		
27	-11.3E-09	-58.5E-09
28	-11.2E-09	-77.1E-09
29	-11.1E-09	-65.7E-09
30	-11.2E-09	-60.4E-09
32	-11.1E-09	-68.0E-09
39	-11.4E-09	-67.3E-09
Statistics		
Min	-11.4E-09	-77.1E-09
Max	-11.1E-09	-58.5E-09
Average	-11.2E-09	-66.2E-09
Sigma	97.9E-12	6.0E-09

Drift Calculation

IIBM3DUTB	0 p/cm²	2E+11 p/cm²
OFF samples		
27	-	-47.21E-09
28	-	-65.89E-09
29	-	-54.60E-09
30	-	-49.25E-09
32	-	-56.93E-09
39	-	-55.94E-09
Average	-	-54.97E-09
Sigma	-	6.01E-09

Test conditions : Protons

Parameter : Input Bias Current : IIBM3DUTC

+VCC=5V. -VCC=GND. VCM=-1.4V

Unit : A

Spec Limit Min : -50.0E-09

Spec Limit Max : 100.0E-12

Spec limits are represented in bold lines on the graphic.

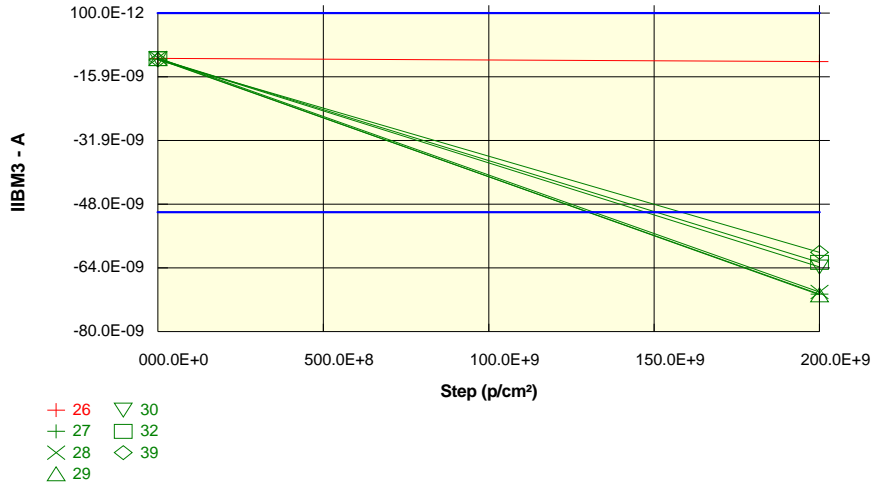

Measurements

IIBM3DUTC	0 p/cm ²	2E+11 p/cm ²
26_REF	-11.3E-09	-12.1E-09
OFF samples		
27	-11.5E-09	-70.6E-09
28	-11.2E-09	-70.1E-09
29	-11.4E-09	-70.7E-09
30	-11.4E-09	-63.7E-09
32	-11.4E-09	-62.6E-09
39	-11.7E-09	-60.1E-09
Statistics		
Min	-11.7E-09	-70.7E-09
Max	-11.2E-09	-60.1E-09
Average	-11.4E-09	-66.3E-09
Sigma	150.3E-12	4.3E-09

Drift Calculation

IIBM3DUTC	0 p/cm ²	2E+11 p/cm ²
OFF samples		
27	-	-59.07E-09
28	-	-58.90E-09
29	-	-59.37E-09
30	-	-52.33E-09
32	-	-51.22E-09
39	-	-48.38E-09
Average	-	-54.88E-09
Sigma	-	4.40E-09

Test conditions : Protons

Parameter : Input Bias Current : IIBM3DUTD

+VCC=5V. -VCC=GND. VCM=-1.4V

Unit : A

Spec Limit Min : -50.0E-09

Spec Limit Max : 100.0E-12

Spec limits are represented in bold lines on the graphic.

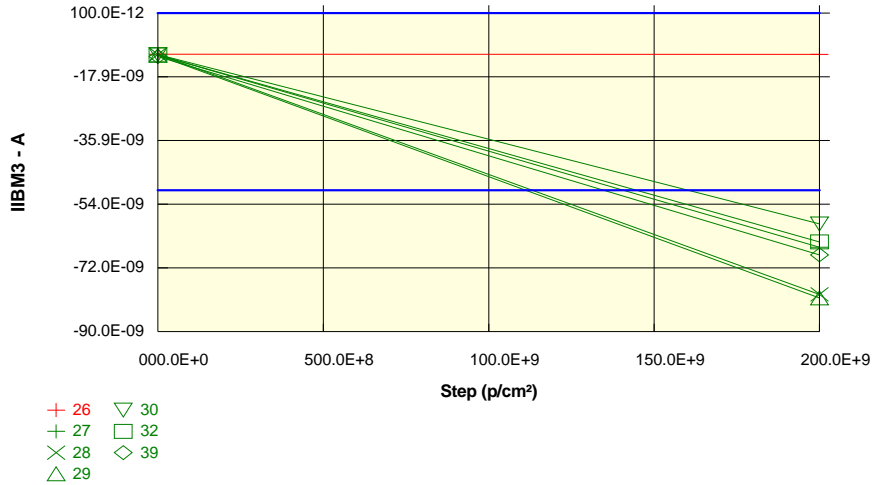

Measurements

IIBM3DUTD	0 p/cm ²	2E+11 p/cm ²
26_REF	-11.6E-09	-11.6E-09
OFF samples		
27	-11.8E-09	-66.1E-09
28	-11.6E-09	-79.5E-09
29	-11.9E-09	-80.5E-09
30	-11.7E-09	-59.5E-09
32	-11.7E-09	-64.6E-09
39	-12.2E-09	-68.3E-09
Statistics		
Min	-12.2E-09	-80.5E-09
Max	-11.6E-09	-59.5E-09
Average	-11.8E-09	-69.8E-09
Sigma	196.9E-12	7.7E-09

Drift Calculation

IIBM3DUTD	0 p/cm ²	2E+11 p/cm ²
OFF samples		
27	-	-54.37E-09
28	-	-67.91E-09
29	-	-68.61E-09
30	-	-47.88E-09
32	-	-52.87E-09
39	-	-56.10E-09
Average	-	-57.96E-09
Sigma	-	7.71E-09

Test conditions : Protons

Parameter : Input Bias Current : IIBM4DUTA

+VCC=2.5V. -VCC=-2.5V. VCM=-1.1V

Unit : A

Spec Limit Min : -50.0E-09

Spec Limit Max : 100.0E-12

Spec limits are represented in bold lines on the graphic.

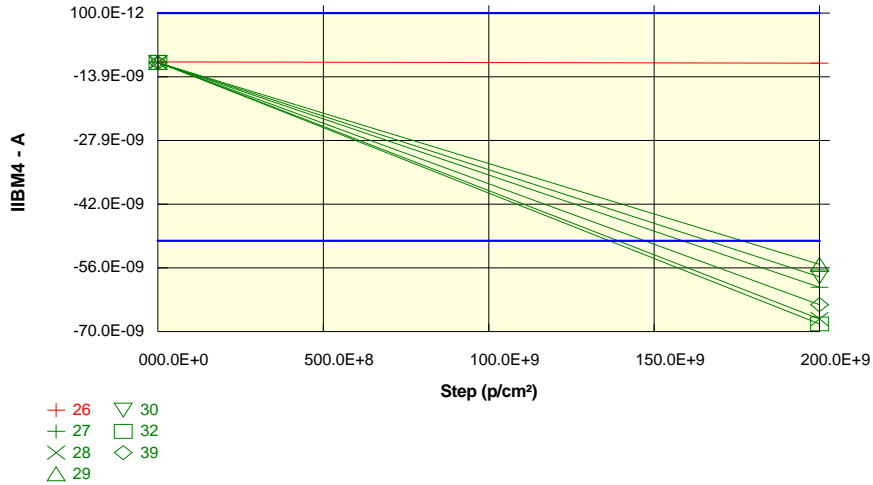

Measurements

IIBM4DUTA	0 p/cm ²	2E+11 p/cm ²
26_REF	-10.6E-09	-10.9E-09
OFF samples		
27	-10.8E-09	-60.2E-09
28	-10.7E-09	-67.2E-09
29	-10.8E-09	-55.2E-09
30	-10.8E-09	-58.0E-09
32	-10.7E-09	-68.3E-09
39	-10.8E-09	-64.1E-09
Statistics		
Min	-10.8E-09	-68.3E-09
Max	-10.7E-09	-55.2E-09
Average	-10.8E-09	-62.2E-09
Sigma	38.3E-12	4.8E-09

Drift Calculation

IIBM4DUTA	0 p/cm ²	2E+11 p/cm ²
OFF samples		
27	-	-49.41E-09
28	-	-56.47E-09
29	-	-44.41E-09
30	-	-47.19E-09
32	-	-57.58E-09
39	-	-53.26E-09
Average	-	-51.39E-09
Sigma	-	4.79E-09

Test conditions : Protons

Parameter : Input Bias Current : IIBM4DUTB

+VCC=2.5V. -VCC=-2.5V. VCM=-1.1V

Unit : A

Spec Limit Min : -50.0E-09

Spec Limit Max : 100.0E-12

Spec limits are represented in bold lines on the graphic.

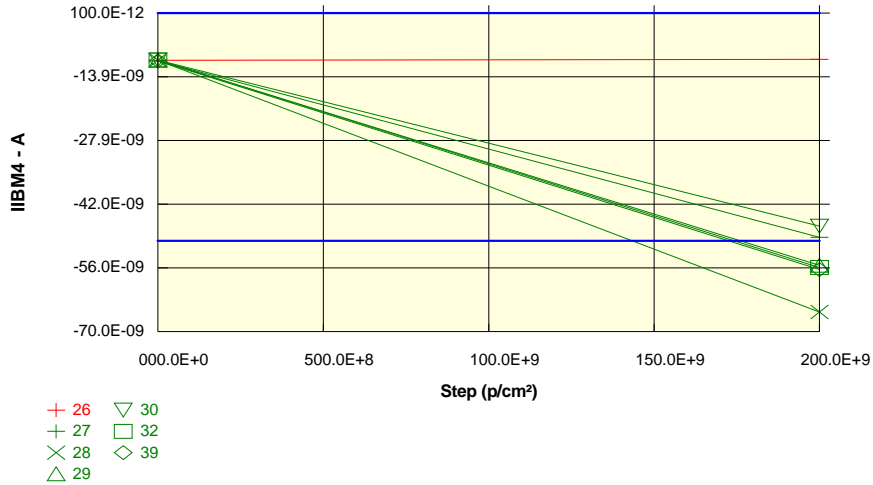

Measurements

IIBM4DUTB	0 p/cm²	2E+11 p/cm²
26_REF	-10.3E-09	-10.1E-09
OFF samples		
27	-10.4E-09	-49.2E-09
28	-10.3E-09	-65.7E-09
29	-10.3E-09	-55.4E-09
30	-10.3E-09	-46.8E-09
32	-10.2E-09	-55.9E-09
39	-10.4E-09	-56.3E-09
Statistics		
Min	-10.4E-09	-65.7E-09
Max	-10.2E-09	-46.8E-09
Average	-10.3E-09	-54.9E-09
Sigma	71.7E-12	6.0E-09

Drift Calculation

IIBM4DUTB	0 p/cm²	2E+11 p/cm²
OFF samples		
27	-	-38.85E-09
28	-	-55.38E-09
29	-	-45.14E-09
30	-	-36.52E-09
32	-	-45.69E-09
39	-	-45.94E-09
Average	-	-44.59E-09
Sigma	-	6.03E-09

Test conditions : Protons

Parameter : Input Bias Current : IIBM4DUTC

+VCC=2.5V. -VCC=-2.5V. VCM=-1.1V

Unit : A

Spec Limit Min : -50.0E-09

Spec Limit Max : 100.0E-12

Spec limits are represented in bold lines on the graphic.

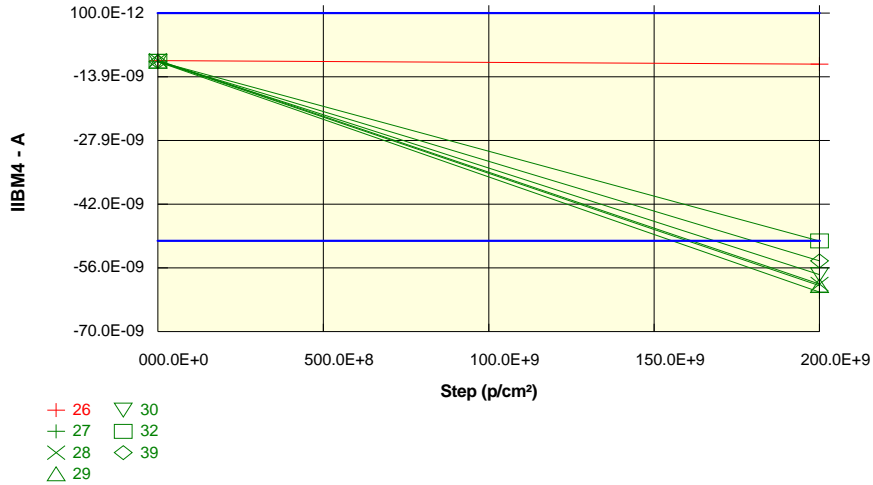

Measurements

IIBM4DUTC	0 p/cm²	2E+11 p/cm²
26_REF	-10.4E-09	-11.1E-09
OFF samples		
27	-10.6E-09	-61.3E-09
28	-10.3E-09	-59.5E-09
29	-10.4E-09	-59.9E-09
30	-10.5E-09	-57.5E-09
32	-10.5E-09	-50.1E-09
39	-10.6E-09	-54.4E-09
Statistics		
Min	-10.6E-09	-61.3E-09
Max	-10.3E-09	-50.1E-09
Average	-10.5E-09	-57.1E-09
Sigma	115.7E-12	3.8E-09

Drift Calculation

IIBM4DUTC	0 p/cm²	2E+11 p/cm²
OFF samples		
27	-	-50.70E-09
28	-	-49.27E-09
29	-	-49.43E-09
30	-	-46.94E-09
32	-	-39.54E-09
39	-	-43.82E-09
Average	-	-46.62E-09
Sigma	-	3.86E-09

Test conditions : Protons

Parameter : Input Bias Current : IIBM4DUTD

+VCC=2.5V. -VCC=-2.5V. VCM=-1.1V

Unit : A

Spec Limit Min : -50.0E-09

Spec Limit Max : 100.0E-12

Spec limits are represented in bold lines on the graphic.

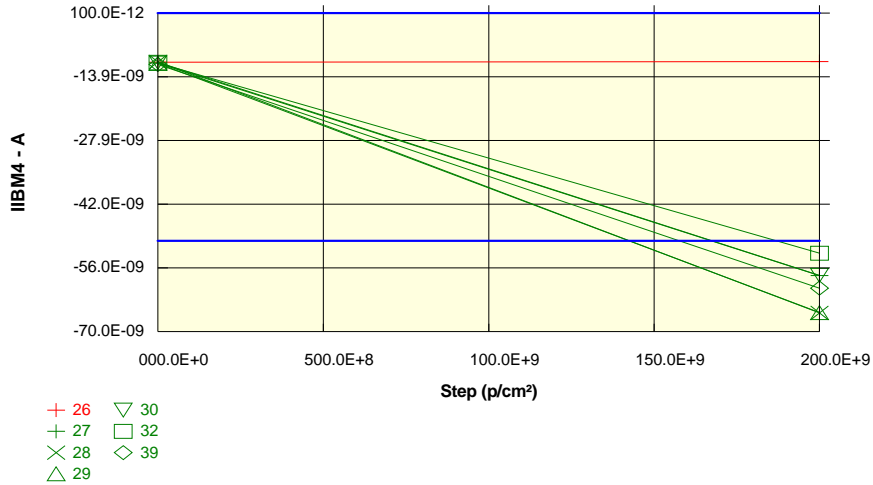

Measurements

IIBM4DUTD	0 p/cm ²	2E+11 p/cm ²
26_REF	-10.7E-09	-10.6E-09
OFF samples		
27	-10.9E-09	-57.7E-09
28	-10.6E-09	-65.9E-09
29	-11.0E-09	-65.8E-09
30	-10.7E-09	-57.6E-09
32	-10.9E-09	-52.8E-09
39	-11.2E-09	-60.4E-09
Statistics		
Min	-11.2E-09	-65.9E-09
Max	-10.6E-09	-52.8E-09
Average	-10.9E-09	-60.0E-09
Sigma	176.5E-12	4.7E-09

Drift Calculation

IIBM4DUTD	0 p/cm ²	2E+11 p/cm ²
OFF samples		
27	-	-46.75E-09
28	-	-55.24E-09
29	-	-54.82E-09
30	-	-46.90E-09
32	-	-41.87E-09
39	-	-49.23E-09
Average	-	-49.13E-09
Sigma	-	4.71E-09

Hirex Engineering	Protons Test Report		Ref.:	HRX/TID/0934
	LM124AJRQMLV	National Semiconductors	Issue:	01

Test conditions : Protons

Parameter : Power Supply Rejection Ratio : PSRRDUTA

-VCC=GND. VCM=-1.4V. 5V<+VCC<30V

Unit : $\mu\text{V/V}$

Spec Limit Min : -100.00

Spec Limit Max : 100.00

Spec limits are represented in bold lines on the graphic.

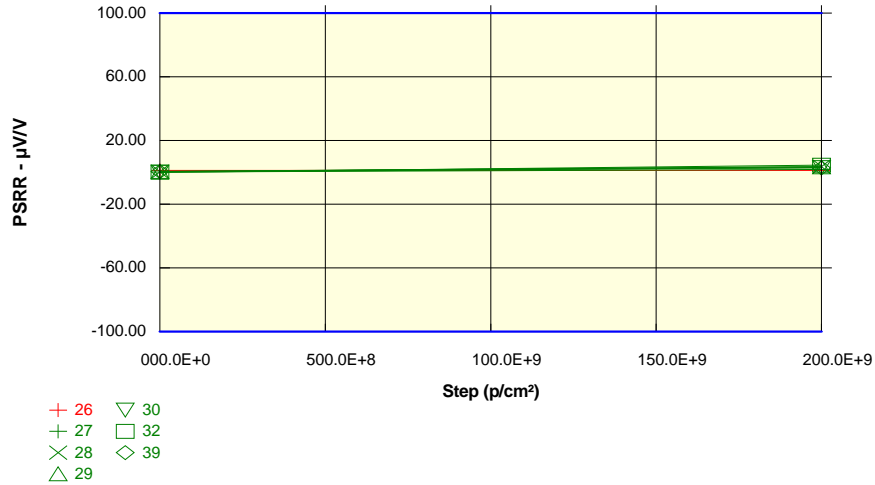

Measurements

PSRRDUTA	0 p/cm ²	2E+11 p/cm ²
26_REF	1.19	1.21
OFF samples		
27	0.19	1.90
28	0.40	3.54
29	0.60	3.50
30	0.14	2.99
32	0.05	4.45
39	0.47	2.74
Statistics		
Min	0.05	1.90
Max	0.60	4.45
Average	0.31	3.18
Sigma	0.20	0.79

Drift Calculation

PSRRDUTA	0 p/cm ²	2E+11 p/cm ²
OFF samples		
27	-	1.71E+00
28	-	3.14E+00
29	-	2.89E+00
30	-	2.85E+00
32	-	4.40E+00
39	-	2.27E+00
Average	-	2.88E+00
Sigma	-	828.16E-03

Hirex Engineering	Protons Test Report		Ref.:	HRX/TID/0934
	LM124AJRQMLV	National Semiconductors	Issue:	01

Test conditions : Protons

Parameter : Power Supply Rejection Ratio : PSRRDUTB

-VCC=GND. VCM=-1.4V. 5V<+VCC<30V

Unit : $\mu\text{V/V}$

Spec Limit Min : -100.00

Spec Limit Max : 100.00

Spec limits are represented in bold lines on the graphic.

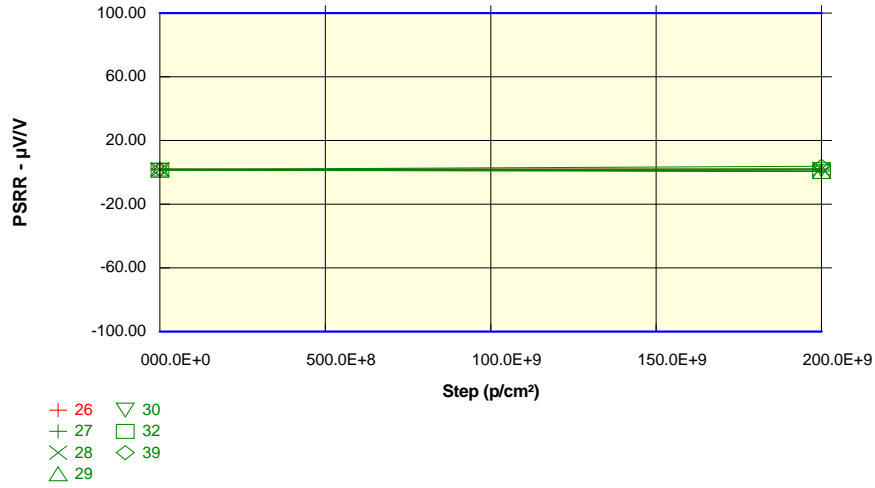

Measurements

PSRRDUTB	0 p/cm ²	2E+11 p/cm ²
26_REF	2.02	1.98
OFF samples		
27	1.90	0.85
28	1.79	2.23
29	2.03	0.61
30	1.39	1.59
32	1.25	0.51
39	1.84	3.82
Statistics		
Min	1.25	0.51
Max	2.03	3.82
Average	1.70	1.60
Sigma	0.28	1.16

Drift Calculation

PSRRDUTB	0 p/cm ²	2E+11 p/cm ²
OFF samples		
27	-	-1.05E+00
28	-	434.40E-03
29	-	-1.42E+00
30	-	206.56E-03
32	-	-747.04E-03
39	-	1.99E+00
Average	-	-98.40E-03
Sigma	-	1.14E+00

Hirex Engineering	Protons Test Report		Ref.:	HRX/TID/0934
	LM124AJRQMLV	National Semiconductors	Issue:	01

Test conditions : Protons

Parameter : Power Supply Rejection Ratio : PSRRDUTC

-VCC=GND. VCM=-1.4V. 5V<+VCC<30V

Unit : $\mu\text{V/V}$

Spec Limit Min : -100.00

Spec Limit Max : 100.00

Spec limits are represented in bold lines on the graphic.

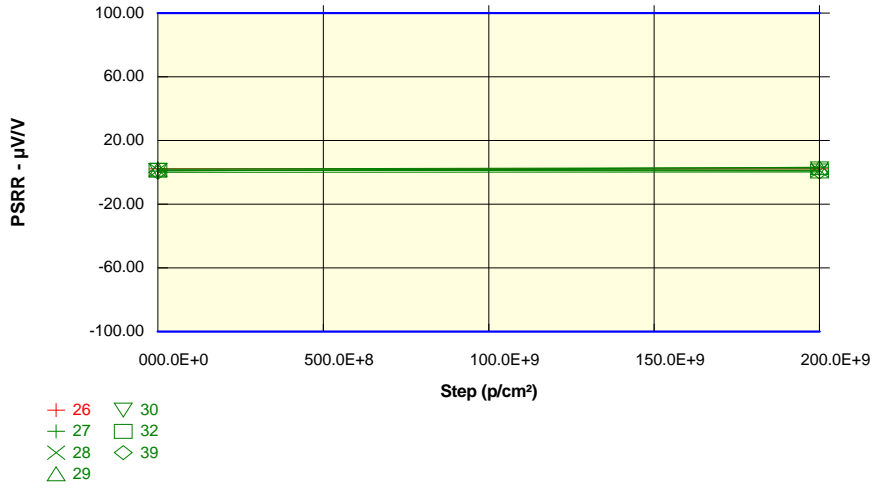

Measurements

PSRRDUTC	0 p/cm ²	2E+11 p/cm ²
26_REF	2.17	2.18
OFF samples		
27	0.80	3.28
28	1.42	1.19
29	2.03	3.01
30	1.11	2.21
32	1.36	0.77
39	0.02	0.23
Statistics		
Min	0.02	0.23
Max	2.03	3.28
Average	1.12	1.78
Sigma	0.62	1.13

Drift Calculation

PSRRDUTC	0 p/cm ²	2E+11 p/cm ²
OFF samples		
27	-	2.48E+00
28	-	-231.20E-03
29	-	979.20E-03
30	-	1.10E+00
32	-	-584.80E-03
39	-	207.52E-03
Average	-	659.65E-03
Sigma	-	1.01E+00

Hirex Engineering	Protons Test Report		Ref.:	HRX/TID/0934
	LM124AJRQMLV	National Semiconductors	Issue:	01

Test conditions : Protons

Parameter : Power Supply Rejection Ratio : PSRRDUTD

-VCC=GND. VCM=-1.4V. 5V<+VCC<30V

Unit : $\mu\text{V/V}$

Spec Limit Min : -100.00

Spec Limit Max : 100.00

Spec limits are represented in bold lines on the graphic.

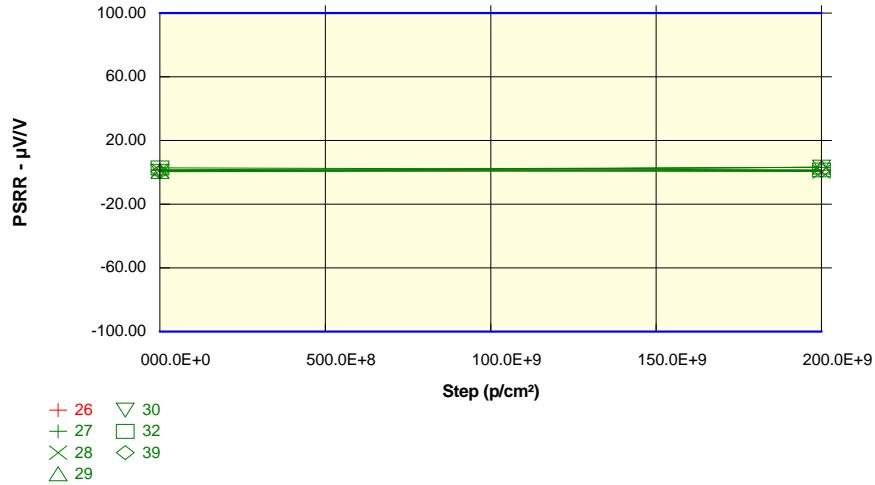

Measurements

PSRRDUTD	0 p/cm ²	2E+11 p/cm ²
26_REF	1.31	1.30
OFF samples		
27	1.62	3.16
28	1.15	0.52
29	0.56	3.18
30	0.72	3.24
32	2.75	1.46
39	0.41	1.16
Statistics		
Min	0.41	0.52
Max	2.75	3.24
Average	1.20	2.12
Sigma	0.80	1.11

Drift Calculation

PSRRDUTD	0 p/cm ²	2E+11 p/cm ²
OFF samples		
27	-	1.54E+00
28	-	-632.32E-03
29	-	2.62E+00
30	-	2.52E+00
32	-	-1.29E+00
39	-	748.96E-03
Average	-	918.72E-03
Sigma	-	1.48E+00

Hirex Engineering	Protons Test Report		Ref.:	HRX/TID/0934
	LM124AJRQLV	National Semiconductors	Issue:	01

Test conditions : Protons

Parameter : Common Mode Rejection Ratio : CMRRDUTA

+VCC=30V. -VCC=GND. VCM=-15V to +VCC=2V. -VCC=-28V. VCM=13V

Unit : dB

Spec Limit Min : 76.00

Spec limits are represented in bold lines on the graphic.

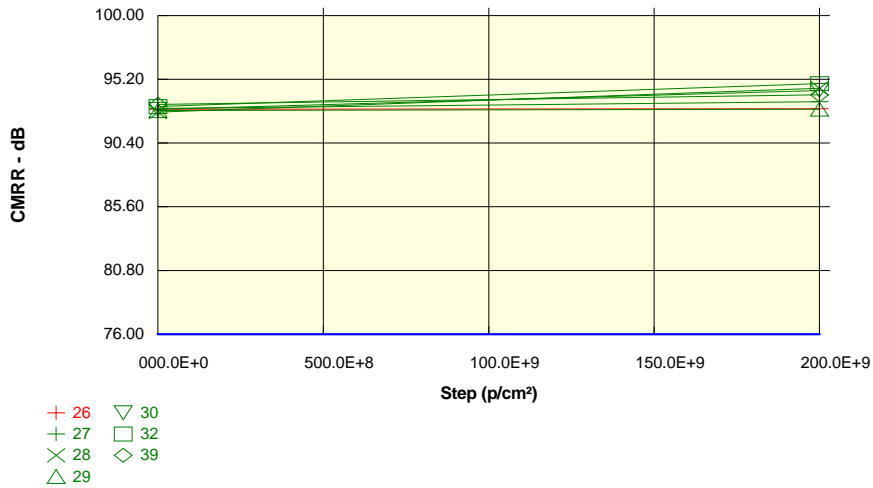

Measurements

CMRRDUTA	0 p/cm²	2E+11 p/cm²
26_REF	92.95	92.98
OFF samples		
27	93.01	93.51
28	92.73	94.53
29	92.85	92.95
30	92.94	94.36
32	93.15	94.87
39	93.31	94.03
Statistics		
Min	92.73	92.95
Max	93.31	94.87
Average	93.00	94.04
Sigma	0.19	0.64

Drift Calculation

CMRRDUTA	0 p/cm²	2E+11 p/cm²
OFF samples		
27	-	507.14E-03
28	-	1.79E+00
29	-	100.75E-03
30	-	1.42E+00
32	-	1.72E+00
39	-	714.73E-03
Average	-	1.04E+00
Sigma	-	638.29E-03

Hirex Engineering	Protons Test Report		Ref.:	HRX/TID/0934
	LM124AJRQLV	National Semiconductors	Issue:	01

Test conditions : Protons

Parameter : Common Mode Rejection Ratio : CMRRDUTB

+VCC=30V. -VCC=GND. VCM=-15V to +VCC=2V. -VCC=-28V. VCM=13V

Unit : dB

Spec Limit Min : 76.00

Spec limits are represented in bold lines on the graphic.

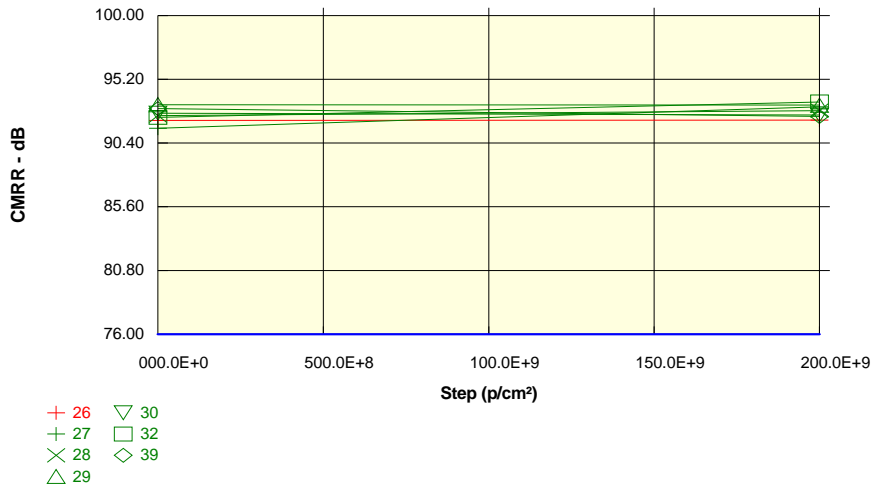

Measurements

CMRRDUTB	0 p/cm²	2E+11 p/cm²
26_REF	92.10	92.12
OFF samples		
27	91.52	93.13
28	92.47	92.85
29	93.29	93.25
30	92.65	92.51
32	92.34	93.50
39	92.99	92.40
Statistics		
Min	91.52	92.40
Max	93.29	93.50
Average	92.54	92.94
Sigma	0.56	0.39

Drift Calculation

CMRRDUTB	0 p/cm²	2E+11 p/cm²
OFF samples		
27	-	1.60E+00
28	-	372.69E-03
29	-	-40.72E-03
30	-	-138.73E-03
32	-	1.16E+00
39	-	-593.31E-03
Average	-	394.11E-03
Sigma	-	763.85E-03

Hirex Engineering	Protons Test Report		Ref.:	HRX/TID/0934
	LM124AJRQLV	National Semiconductors	Issue:	01

Test conditions : Protons

Parameter : Common Mode Rejection Ratio : CMRRDUTC

+VCC=30V. -VCC=GND. VCM=-15V to +VCC=2V. -VCC=-28V. VCM=13V

Unit : dB

Spec Limit Min : 76.00

Spec limits are represented in bold lines on the graphic.

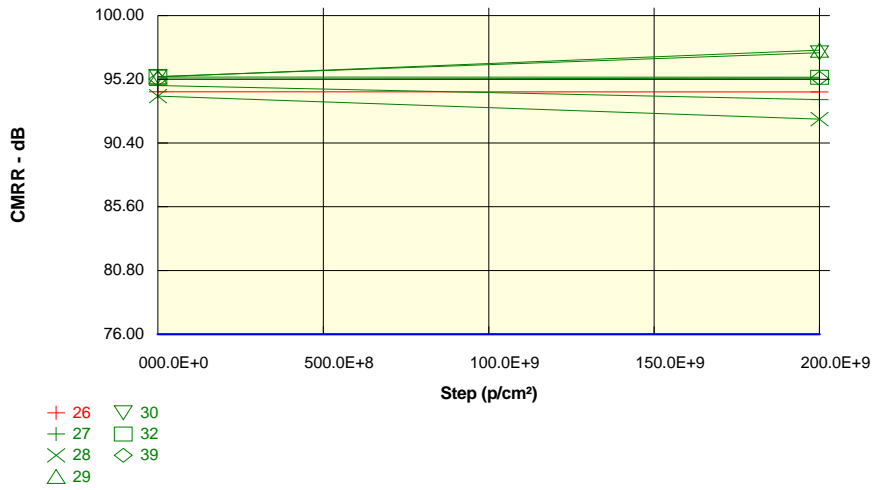

Measurements

CMRRDUTC	0 p/cm²	2E+11 p/cm²
26_REF	94.26	94.25
OFF samples		
27	94.73	93.68
28	93.93	92.20
29	95.39	97.40
30	95.41	97.20
32	95.36	95.35
39	95.21	95.28
Statistics		
Min	93.93	92.20
Max	95.41	97.40
Average	95.01	95.18
Sigma	0.53	1.83

Drift Calculation

CMRRDUTC	0 p/cm²	2E+11 p/cm²
OFF samples		
27	-	-1.06E+00
28	-	-1.73E+00
29	-	2.02E+00
30	-	1.79E+00
32	-	-13.45E-03
39	-	71.13E-03
Average	-	179.19E-03
Sigma	-	1.36E+00

Hirex Engineering	Protons Test Report		Ref.:	HRX/TID/0934
	LM124AJRQLV	National Semiconductors	Issue:	01

Test conditions : Protons

Parameter : Common Mode Rejection Ratio : CMRRDUTD

+VCC=30V. -VCC=GND. VCM=-15V to +VCC=2V. -VCC=-28V. VCM=13V

Unit : dB

Spec Limit Min : 76.00

Spec limits are represented in bold lines on the graphic.

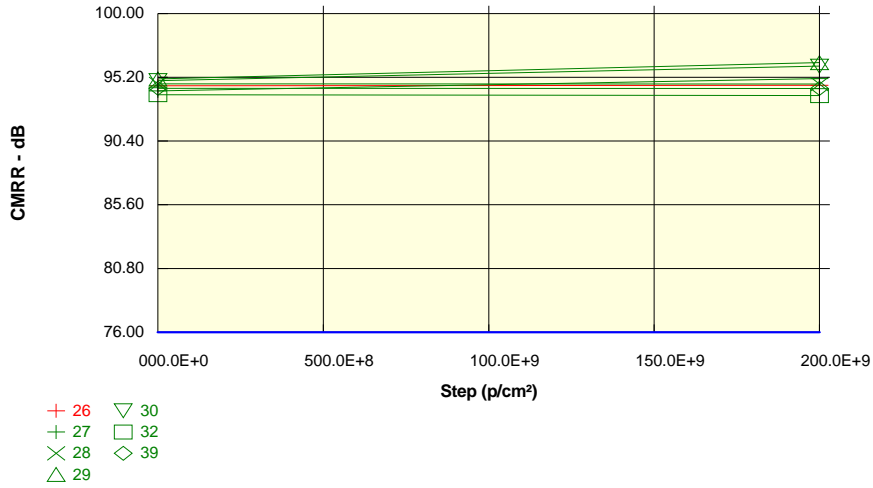

Measurements

CMRRDUTD	0 p/cm²	2E+11 p/cm²
26_REF	94.57	94.60
OFF samples		
27	94.18	95.10
28	94.70	94.69
29	95.07	96.30
30	94.96	96.05
32	93.90	93.83
39	94.38	94.37
Statistics		
Min	93.90	93.83
Max	95.07	96.30
Average	94.53	95.06
Sigma	0.42	0.88

Drift Calculation

CMRRDUTD	0 p/cm²	2E+11 p/cm²
OFF samples		
27	-	922.04E-03
28	-	-13.82E-03
29	-	1.23E+00
30	-	1.09E+00
32	-	-68.74E-03
39	-	-9.28E-03
Average	-	524.74E-03
Sigma	-	562.76E-03

Hirex Engineering	Protons Test Report		Ref.:	HRX/TID/0934
	LM124AJRQMLV	National Semiconductors	Issue:	01

Test conditions : Protons

Parameter : Power Supply Current : ICC

+VCC=30V, -VCC=GND

Unit : A

Spec Limit Max : 3.0E-03

Spec limits are represented in bold lines on the graphic.

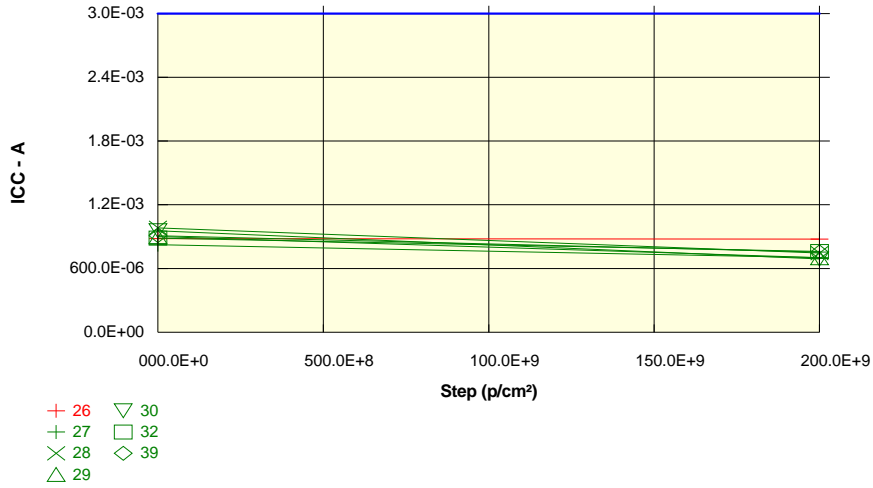

Measurements		
ICC	0 p/cm ²	2E+11 p/cm ²
26 REF	881.2E-06	875.2E-06
OFF samples		
27	823.8E-06	702.2E-06
28	983.1E-06	745.4E-06
29	900.4E-06	701.1E-06
30	954.7E-06	690.2E-06
32	885.8E-06	759.9E-06
39	908.7E-06	756.1E-06
Statistics		
Min	823.8E-06	690.2E-06
Max	983.1E-06	759.9E-06
Average	909.4E-06	725.8E-06
Sigma	50.7E-06	28.6E-06

Drift Calculation		
ICC	0 p/cm ²	2E+11 p/cm ²
OFF samples		
27	-	-121.66E-06
28	-	-237.64E-06
29	-	-199.32E-06
30	-	-264.50E-06
32	-	-125.88E-06
39	-	-152.60E-06
Average	-	-183.60E-06
Sigma	-	54.53E-06

Test conditions : Protons

Parameter : Voltage Gain : AVS1_1DUTA

+VCC=30V, -VCC=GND, 1V<Vout<26V, RL=10K

Unit : V/mV

Spec Limit Min : 50.0

Spec limits are represented in bold lines on the graphic.

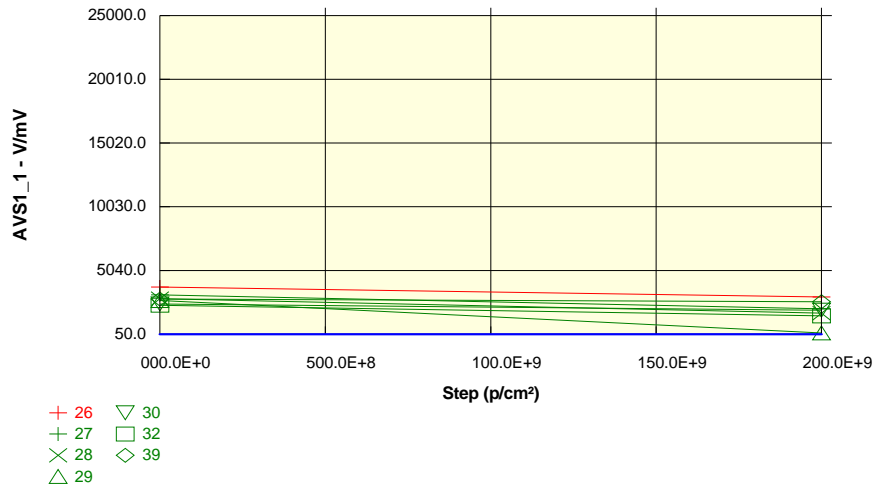

Measurements		
AVS1_1DUTA	0 p/cm ²	2E+11 p/cm ²
26_REF	3749.3	2964.9
OFF samples		
27	3128.1	2038.3
28	2829.3	1698.2
29	2687.0	154.2
30	2414.1	1935.0
32	2314.8	1491.6
39	2803.9	2595.6
Statistics		
Min	2314.8	154.2
Max	3128.1	2595.6
Average	2696.2	1652.2
Sigma	271.1	751.8

Drift Calculation		
AVS1_1DUTA	0 p/cm ²	2E+11 p/cm ²
OFF samples		
27	-	-1.09E+03
28	-	-1.13E+03
29	-	-2.53E+03
30	-	-479.07E+00
32	-	-823.17E+00
39	-	-208.36E+00
Average	-	-1.04E+03
Sigma	-	740.76E+00

Test conditions : Protons

Parameter : Voltage Gain : AVS1_1DUTB

+VCC=30V, -VCC=GND, 1V<Vout<26V, RL=10K

Unit : V/mV

Spec Limit Min : 50.0

Spec limits are represented in bold lines on the graphic.

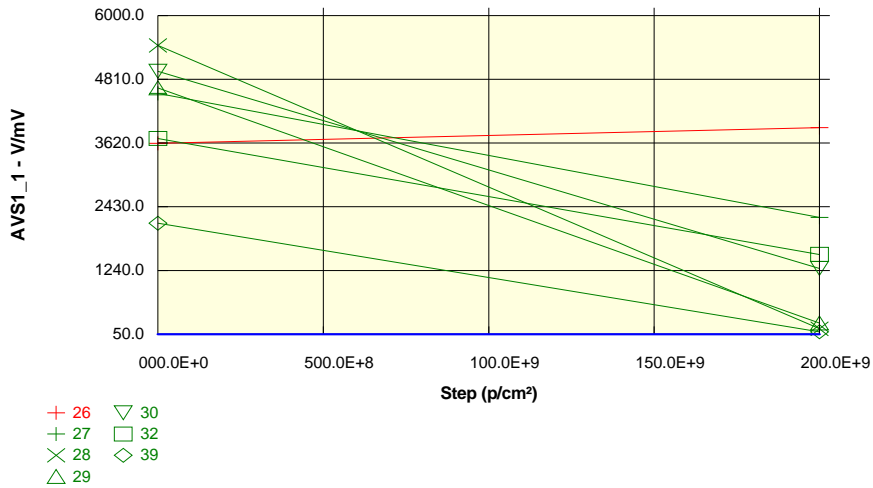

Measurements

AVS1_1DUTB	0 p/cm ²	2E+11 p/cm ²
26_REF	3612.7	3906.2
OFF samples		
27	4548.8	2232.1
28	5444.2	151.1
29	4650.3	259.6
30	4960.3	1278.1
32	3707.0	1539.4
39	2122.2	94.9
Statistics		
Min	2122.2	94.9
Max	5444.2	2232.1
Average	4238.8	925.9
Sigma	1080.3	810.5

Drift Calculation

AVS1_1DUTB	0 p/cm ²	2E+11 p/cm ²
OFF samples		
27	-	-2.32E+03
28	-	-5.29E+03
29	-	-4.39E+03
30	-	-3.68E+03
32	-	-2.17E+03
39	-	-2.03E+03
Average	-	-3.31E+03
Sigma	-	1.24E+03

Test conditions : Protons

Parameter : Voltage Gain : AVS1_1DUTC

+VCC=30V, -VCC=GND, 1V<Vout<26V, RL=10K

Unit : V/mV

Spec Limit Min : 50.0

Spec limits are represented in bold lines on the graphic.

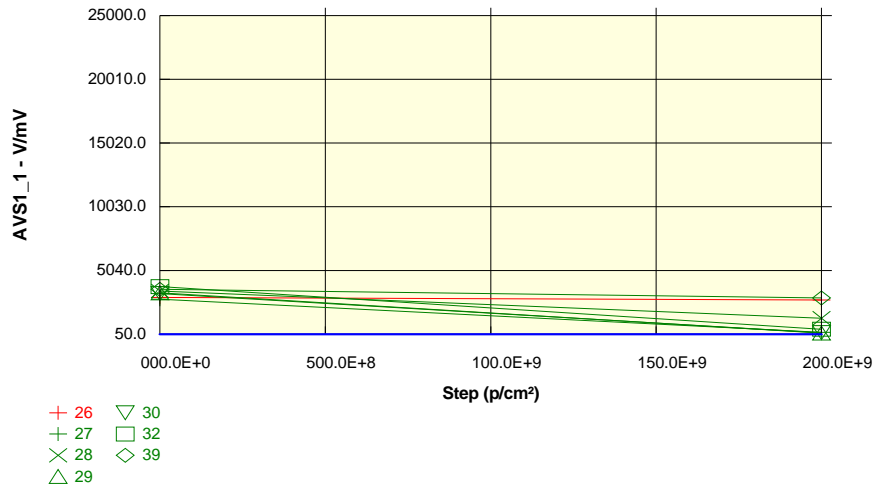

Measurements		
AVS1_1DUTC	0 p/cm ²	2E+11 p/cm ²
26 REF	2937.0	2736.4
OFF samples		
27	2792.7	193.7
28	3436.0	1304.8
29	3289.5	135.4
30	3238.3	171.9
32	3783.3	432.8
39	3559.2	2893.7
Statistics		
Min	2792.7	135.4
Max	3783.3	2893.7
Average	3349.8	855.4
Sigma	307.0	996.5

Drift Calculation		
AVS1_1DUTC	0 p/cm ²	2E+11 p/cm ²
OFF samples		
27	-	-2.60E+03
28	-	-2.13E+03
29	-	-3.15E+03
30	-	-3.07E+03
32	-	-3.35E+03
39	-	-665.55E+00
Average	-	-2.49E+03
Sigma	-	911.30E+00

Test conditions : Protons

Parameter : Voltage Gain : AVS1_1DUTD

+VCC=30V, -VCC=GND, 1V<Vout<26V, RL=10K

Unit : V/mV

Spec Limit Min : 50.0

Spec limits are represented in bold lines on the graphic.

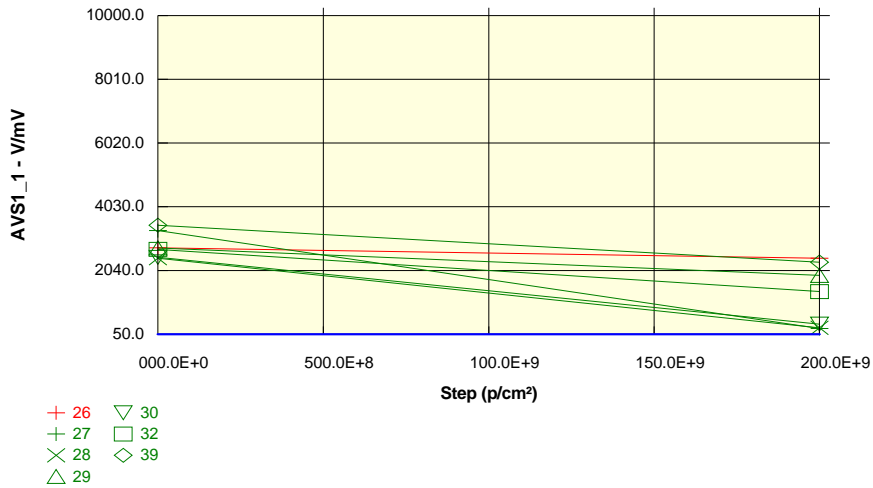

Measurements

AVS1_1DUTD	0 p/cm ²	2E+11 p/cm ²
26 REF	2747.3	2424.4
OFF samples		
27	3289.5	227.7
28	2423.4	252.2
29	2742.4	1888.2
30	2450.0	363.0
32	2697.5	1382.7
39	3454.9	2300.6
Statistics		
Min	2423.4	227.7
Max	3454.9	2300.6
Average	2843.0	1069.1
Sigma	394.9	832.6

Drift Calculation

AVS1_1DUTD	0 p/cm ²	2E+11 p/cm ²
OFF samples		
27	-	-3.06E+03
28	-	-2.17E+03
29	-	-854.22E+00
30	-	-2.09E+03
32	-	-1.31E+03
39	-	-1.15E+03
Average	-	-1.77E+03
Sigma	-	747.78E+00

Hirex Engineering	Protons Test Report		Ref.:	HRX/TID/0934
	LM124AJRQLV	National Semiconductors	Issue:	01

Test conditions : Protons

Parameter : Voltage Gain : AVS1_2DUTA

+VCC=30V. -VCC=GND. 5V<Vout<20V. RL=2K

Unit : V/mV

Spec Limit Min : 50.0

Spec limits are represented in bold lines on the graphic.

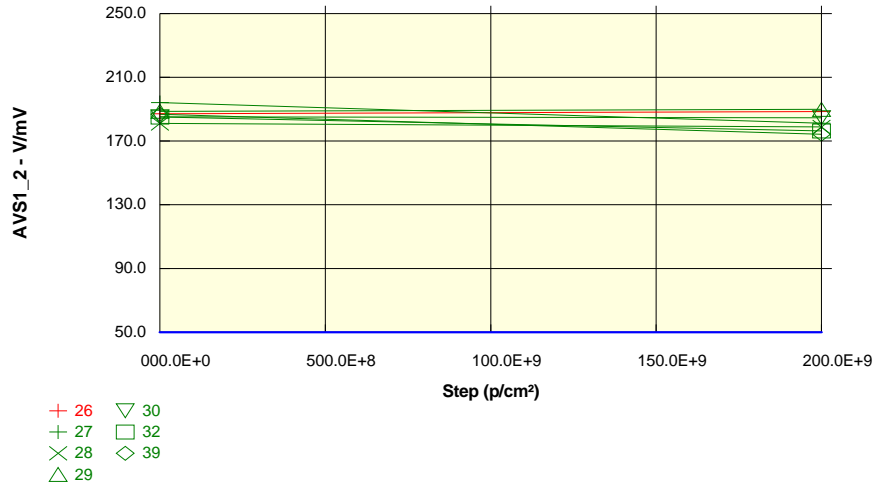

Measurements

AVS1_2DUTA	0 p/cm²	2E+11 p/cm²
26_REF	187.1	188.5
OFF samples		
27	194.1	181.1
28	181.1	178.8
29	188.7	189.9
30	185.2	184.6
32	185.1	176.4
39	186.8	174.3
Statistics		
Min	181.1	174.3
Max	194.1	189.9
Average	186.8	180.8
Sigma	4.0	5.2

Drift Calculation

AVS1_2DUTA	0 p/cm²	2E+11 p/cm²
OFF samples		
27	-	-12.96E+00
28	-	-2.26E+00
29	-	1.20E+00
30	-	-592.61E-03
32	-	-8.73E+00
39	-	-12.50E+00
Average	-	-5.97E+00
Sigma	-	5.67E+00

Hirex Engineering	Protons Test Report		Ref.:	HRX/TID/0934
	LM124AJRQLV	National Semiconductors	Issue:	01

Test conditions : Protons

Parameter : Voltage Gain : AVS1_2DUTB

+VCC=30V. -VCC=GND. 5V<Vout<20V. RL=2K

Unit : V/mV

Spec Limit Min : 50.0

Spec limits are represented in bold lines on the graphic.

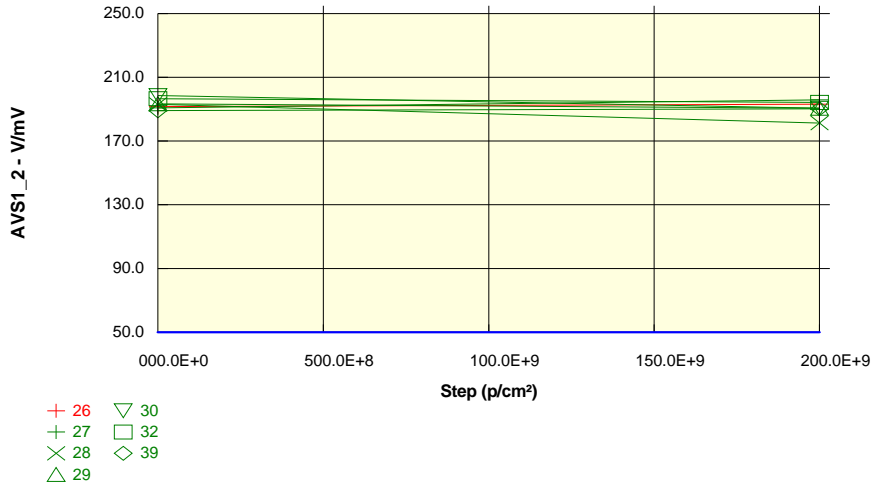

Measurements

AVS1_2DUTB	0 p/cm²	2E+11 p/cm²
26_REF	191.7	193.1
OFF samples		
27	190.8	195.9
28	193.0	181.3
29	193.4	190.5
30	198.5	190.6
32	196.5	194.2
39	189.0	190.3
Statistics		
Min	189.0	181.3
Max	198.5	195.9
Average	193.6	190.5
Sigma	3.2	4.6

Drift Calculation

AVS1_2DUTB	0 p/cm²	2E+11 p/cm²
OFF samples		
27	-	5.06E+00
28	-	-11.71E+00
29	-	-2.85E+00
30	-	-7.97E+00
32	-	-2.33E+00
39	-	1.22E+00
Average	-	-3.10E+00
Sigma	-	5.53E+00

Test conditions : Protons

Parameter : Voltage Gain : AVS1_2DUTC

+VCC=30V. -VCC=GND. 5V<Vout<20V. RL=2K

Unit : V/mV

Spec Limit Min : 50.0

Spec limits are represented in bold lines on the graphic.

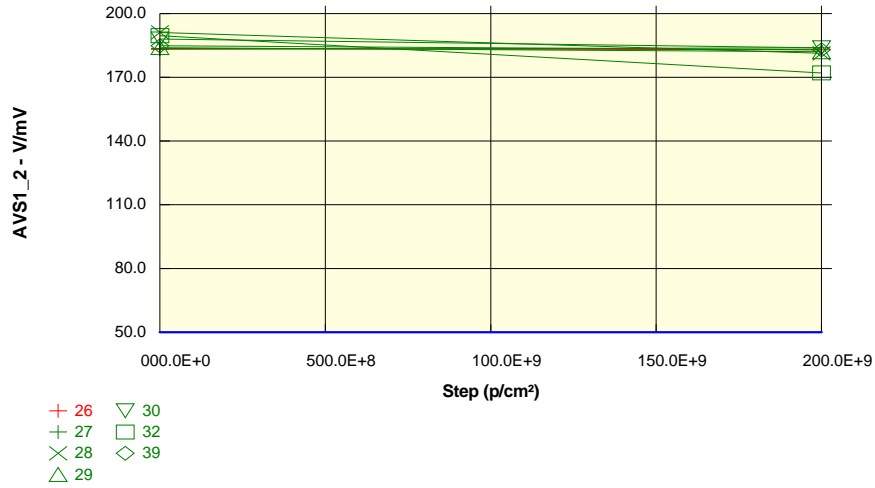

Measurements

AVS1_2DUTC	0 p/cm ²	2E+11 p/cm ²
26_REF	183.5	182.9
OFF samples		
27	183.2	183.9
28	191.1	181.3
29	184.0	182.0
30	188.0	183.9
32	189.6	172.1
39	184.8	182.9
Statistics		
Min	183.2	172.1
Max	191.1	183.9
Average	186.8	181.0
Sigma	3.0	4.1

Drift Calculation

AVS1_2DUTC	0 p/cm ²	2E+11 p/cm ²
OFF samples		
27	-	718.72E-03
28	-	-9.85E+00
29	-	-1.96E+00
30	-	-4.10E+00
32	-	-17.53E+00
39	-	-1.88E+00
Average	-	-5.76E+00
Sigma	-	6.18E+00

Test conditions : Protons

Parameter : Voltage Gain : AVS1_2DUTD

+VCC=30V. -VCC=GND. 5V<Vout<20V. RL=2K

Unit : V/mV

Spec Limit Min : 50.0

Spec limits are represented in bold lines on the graphic.

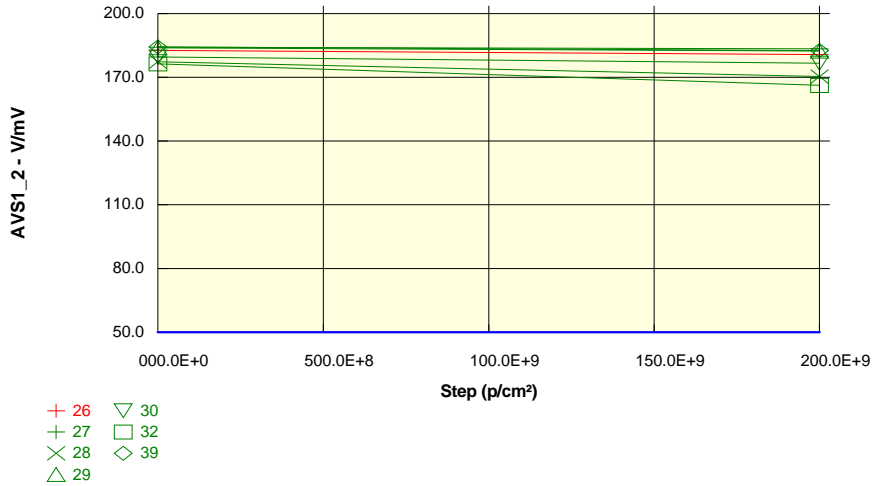

Measurements

AVS1_2DUTD	0 p/cm ²	2E+11 p/cm ²
26_REF	182.7	180.7
OFF samples		
27	184.1	183.5
28	177.3	170.4
29	183.9	182.4
30	179.6	176.7
32	176.3	166.2
39	184.3	182.6
Statistics		
Min	176.3	166.2
Max	184.3	183.5
Average	180.9	177.0
Sigma	3.3	6.6

Drift Calculation

AVS1_2DUTD	0 p/cm ²	2E+11 p/cm ²
OFF samples		
27	-	-612.40E-03
28	-	-6.95E+00
29	-	-1.54E+00
30	-	-2.94E+00
32	-	-10.13E+00
39	-	-1.72E+00
Average	-	-3.98E+00
Sigma	-	3.42E+00

Test conditions : Protons

Parameter : Voltage Gain : AVS2_1DUTA

+VCC=5V. -VCC=GND. 1V<Vout<2.5V. RL=10K

Unit : V/mV

Spec Limit Min : 10.0

Spec limits are represented in bold lines on the graphic.

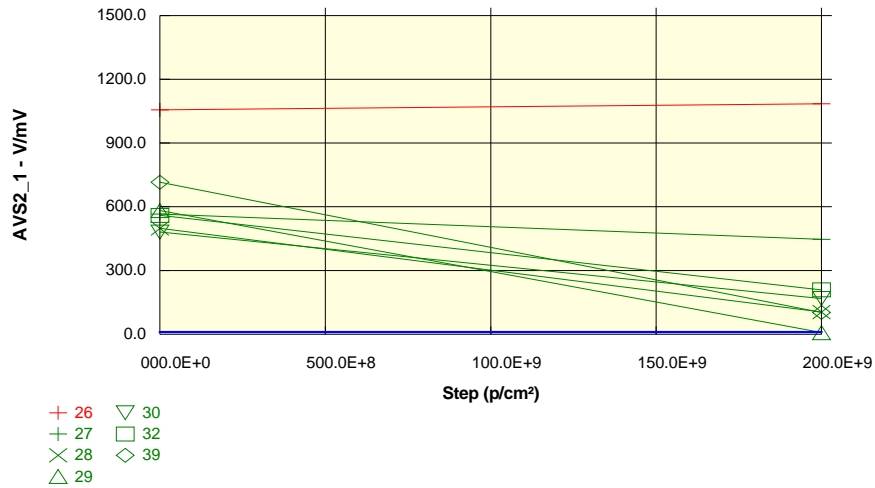

Measurements

AVS2_1DUTA	0 p/cm²	2E+11 p/cm²
26_REF	1056.3	1084.6
OFF samples		
27	565.6	446.4
28	498.0	104.2
29	582.3	7.4
30	480.8	168.2
32	559.7	208.3
39	715.6	103.0
Statistics		
Min	480.8	7.4
Max	715.6	446.4
Average	567.0	172.9
Sigma	75.9	137.3

Drift Calculation

AVS2_1DUTA	0 p/cm²	2E+11 p/cm²
OFF samples		
27	-	-119.18E+00
28	-	-393.84E+00
29	-	-574.92E+00
30	-	-312.61E+00
32	-	-351.37E+00
39	-	-612.70E+00
Average	-	-394.10E+00
Sigma	-	165.59E+00

Test conditions : Protons

Parameter : Voltage Gain : AVS2_1DUTB

+VCC=5V. -VCC=GND. 1V<Vout<2.5V. RL=10K

Unit : V/mV

Spec Limit Min : 10.0

Spec limits are represented in bold lines on the graphic.

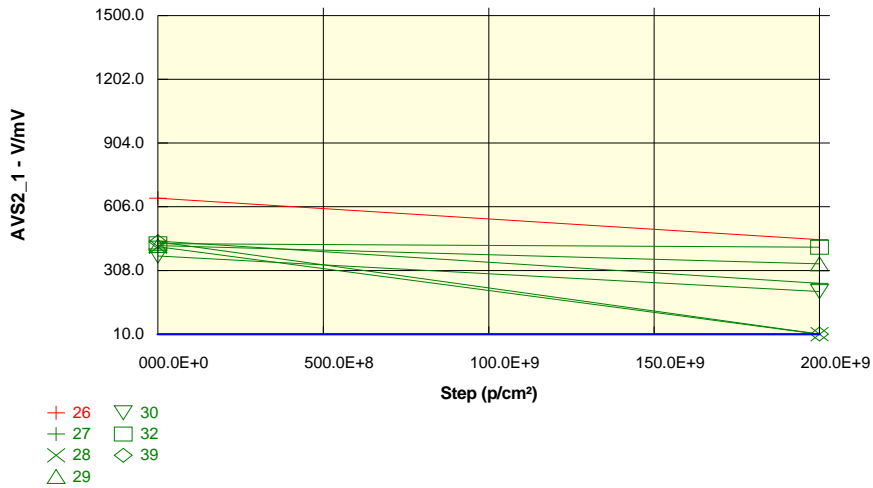

Measurements

AVS2_1DUTB	0 p/cm ²	2E+11 p/cm ²
26_REF	646.6	451.8
OFF samples		
27	444.8	248.3
28	419.0	10.1
29	424.7	339.3
30	376.1	209.5
32	433.0	416.7
39	442.2	11.1
Statistics		
Min	376.1	10.1
Max	444.8	416.7
Average	423.3	205.8
Sigma	23.0	152.9

Drift Calculation

AVS2_1DUTB	0 p/cm ²	2E+11 p/cm ²
OFF samples		
27	-	-196.50E+00
28	-	-408.87E+00
29	-	-85.40E+00
30	-	-166.63E+00
32	-	-16.36E+00
39	-	-431.16E+00
Average	-	-217.49E+00
Sigma	-	154.49E+00

Test conditions : Protons

Parameter : Voltage Gain : AVS2_1DUTC

+VCC=5V. -VCC=GND. 1V<Vout<2.5V. RL=10K

Unit : V/mV

Spec Limit Min : 10.0

Spec limits are represented in bold lines on the graphic.

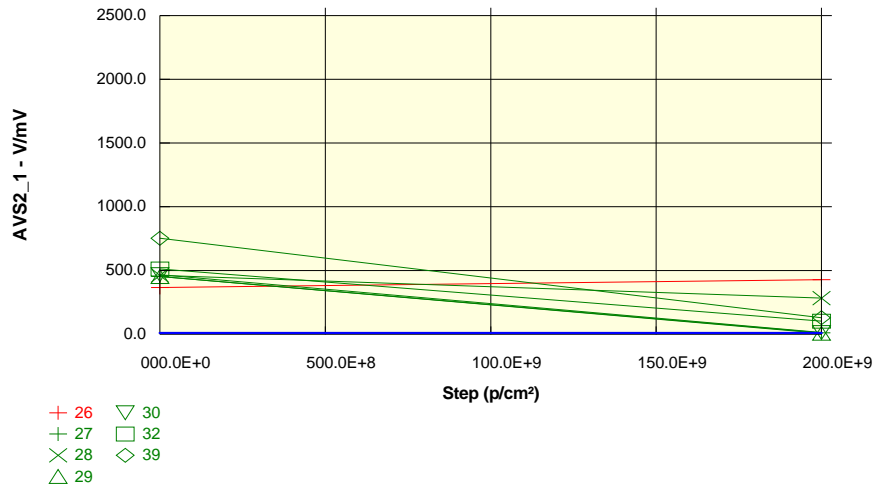

Measurements

AVS2_1DUTC	0 p/cm ²	2E+11 p/cm ²
26_REF	366.6	428.1
OFF samples		
27	452.9	12.1
28	461.8	283.3
29	452.4	7.7
30	467.0	12.6
32	511.6	101.9
39	753.0	129.4
Statistics		
Min	452.4	7.7
Max	753.0	283.3
Average	516.4	91.2
Sigma	107.7	98.2

Drift Calculation

AVS2_1DUTC	0 p/cm ²	2E+11 p/cm ²
OFF samples		
27	-	-440.75E+00
28	-	-178.49E+00
29	-	-444.61E+00
30	-	-454.36E+00
32	-	-409.69E+00
39	-	-623.57E+00
Average	-	-425.25E+00
Sigma	-	130.34E+00

Hirex Engineering	Protons Test Report		Ref.:	HRX/TID/0934
	LM124AJRQLV	National Semiconductors	Issue:	01

Test conditions : Protons

Parameter : Voltage Gain : AVS2_1DUTD

+VCC=5V. -VCC=GND. 1V<Vout<2.5V. RL=10K

Unit : V/mV

Spec Limit Min : 10.0

Spec limits are represented in bold lines on the graphic.

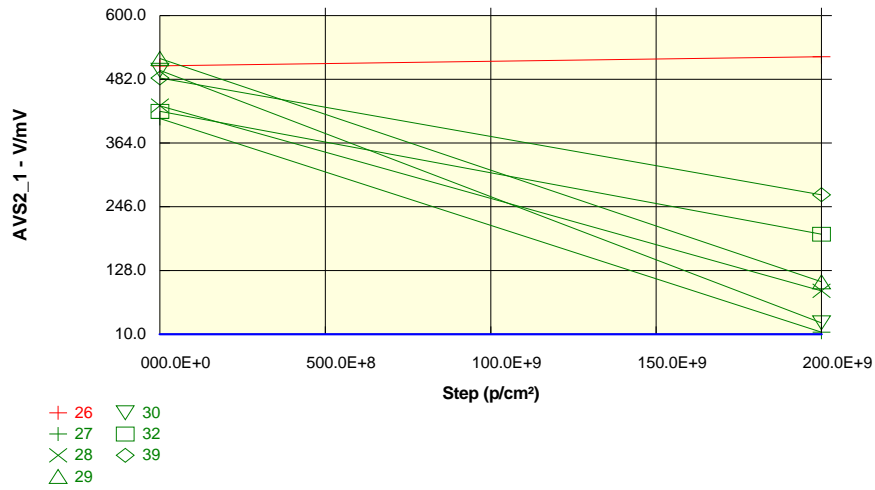

Measurements

AVS2_1DUTD	0 p/cm ²	2E+11 p/cm ²
26_REF	506.8	523.7
OFF samples		
27	409.4	13.9
28	433.0	90.4
29	520.8	107.1
30	498.7	31.0
32	422.8	195.3
39	484.5	268.2
Statistics		
Min	409.4	13.9
Max	520.8	268.2
Average	461.5	117.6
Sigma	41.7	89.3

Drift Calculation

AVS2_1DUTD	0 p/cm ²	2E+11 p/cm ²
OFF samples		
27	-	-395.53E+00
28	-	-342.66E+00
29	-	-413.69E+00
30	-	-467.70E+00
32	-	-227.46E+00
39	-	-216.26E+00
Average	-	-343.88E+00
Sigma	-	93.73E+00

Test conditions : Protons

Parameter : Voltage Gain : AVS2_2DUTA

+VCC=5V. -VCC=GND. 1V<Vout<2.5V. RL=2K

Unit : V/mV

Spec Limit Min : 10.0

Spec limits are represented in bold lines on the graphic.

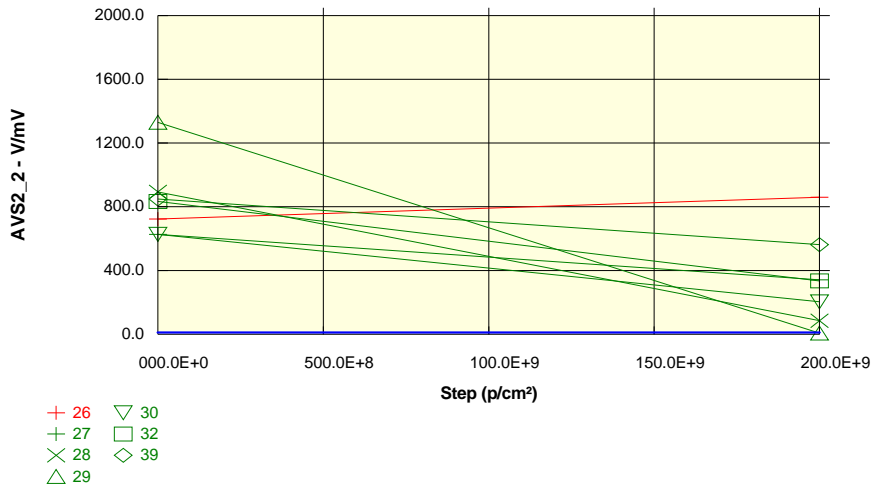

Measurements

AVS2_2DUTA	0 p/cm²	2E+11 p/cm²
26_REF	722.5	859.3
OFF samples		
27	626.0	340.9
28	892.9	85.0
29	1329.8	7.4
30	627.1	203.8
32	833.3	334.8
39	848.4	562.6
Statistics		
Min	626.0	7.4
Max	1329.8	562.6
Average	859.6	255.7
Sigma	235.1	183.1

Drift Calculation

AVS2_2DUTA	0 p/cm²	2E+11 p/cm²
OFF samples		
27	-	-285.13E+00
28	-	-807.82E+00
29	-	-1.32E+03
30	-	-423.28E+00
32	-	-498.51E+00
39	-	-285.87E+00
Average	-	-603.84E+00
Sigma	-	366.14E+00

Test conditions : Protons

Parameter : Voltage Gain : AVS2_2DUTB

+VCC=5V. -VCC=GND. 1V<Vout<2.5V. RL=2K

Unit : V/mV

Spec Limit Min : 10.0

Spec limits are represented in bold lines on the graphic.

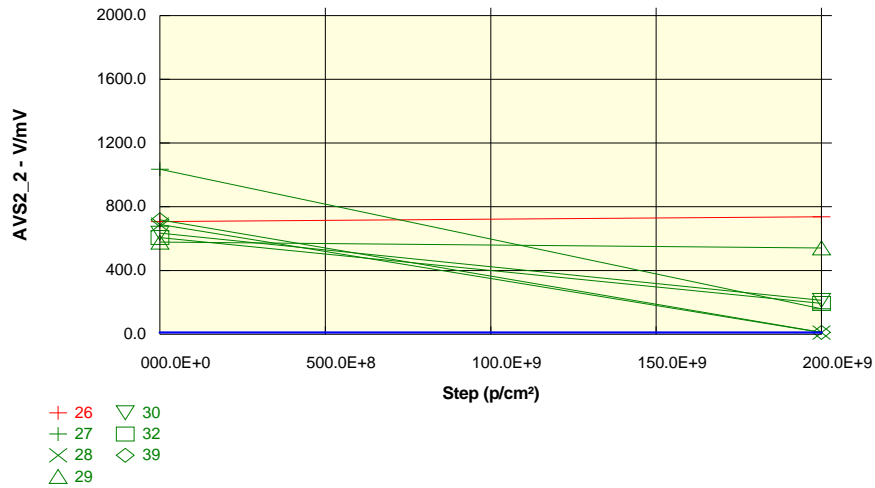

Measurements

AVS2_2DUTB	0 p/cm ²	2E+11 p/cm ²
26_REF	707.5	736.4
OFF samples		
27	1035.9	160.3
28	688.1	10.1
29	577.8	541.7
30	634.5	213.1
32	606.8	193.3
39	718.4	11.3
Statistics		
Min	577.8	10.1
Max	1035.9	541.7
Average	710.3	188.3
Sigma	153.1	177.7

Drift Calculation

AVS2_2DUTB	0 p/cm ²	2E+11 p/cm ²
OFF samples		
27	-	-875.66E+00
28	-	-677.98E+00
29	-	-36.15E+00
30	-	-421.45E+00
32	-	-413.50E+00
39	-	-707.08E+00
Average	-	-521.97E+00
Sigma	-	271.29E+00

Test conditions : Protons

Parameter : Voltage Gain : AVS2_2DUTC

+VCC=5V. -VCC=GND. 1V<Vout<2.5V. RL=2K

Unit : V/mV

Spec Limit Min : 10.0

Spec limits are represented in bold lines on the graphic.

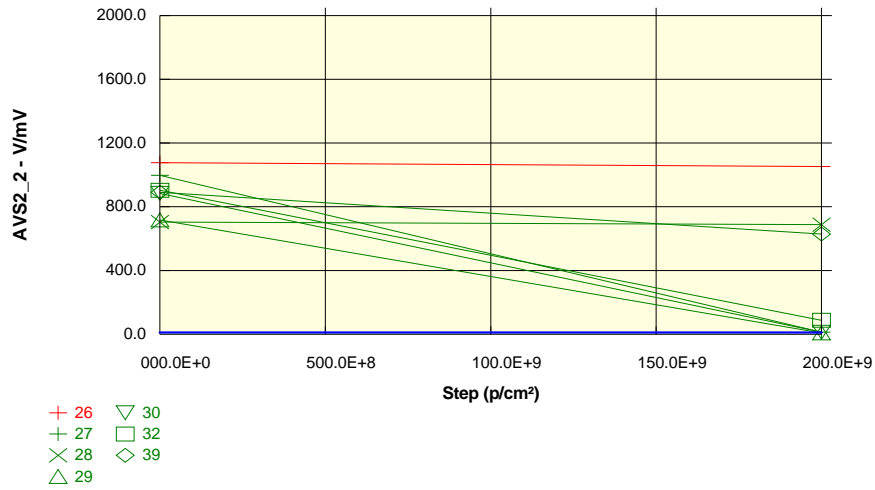

Measurements		
AVS2_2DUTC	0 p/cm ²	2E+11 p/cm ²
26_REF	1077.6	1053.4
OFF samples		
27	997.3	12.2
28	703.6	687.4
29	717.0	7.7
30	884.4	12.2
32	903.6	87.0
39	890.7	629.2
Statistics		
Min	703.6	7.7
Max	997.3	687.4
Average	849.5	239.3
Sigma	105.3	298.0

Drift Calculation		
AVS2_2DUTC	0 p/cm ²	2E+11 p/cm ²
OFF samples		
27	-	-985.11E+00
28	-	-16.14E+00
29	-	-709.32E+00
30	-	-872.28E+00
32	-	-816.61E+00
39	-	-261.54E+00
Average	-	-610.17E+00
Sigma	-	350.27E+00

Test conditions : Protons

Parameter : Voltage Gain : AVS2_2DUTD

+VCC=5V. -VCC=GND. 1V<Vout<2.5V. RL=2K

Unit : V/mV

Spec Limit Min : 10.0

Spec limits are represented in bold lines on the graphic.

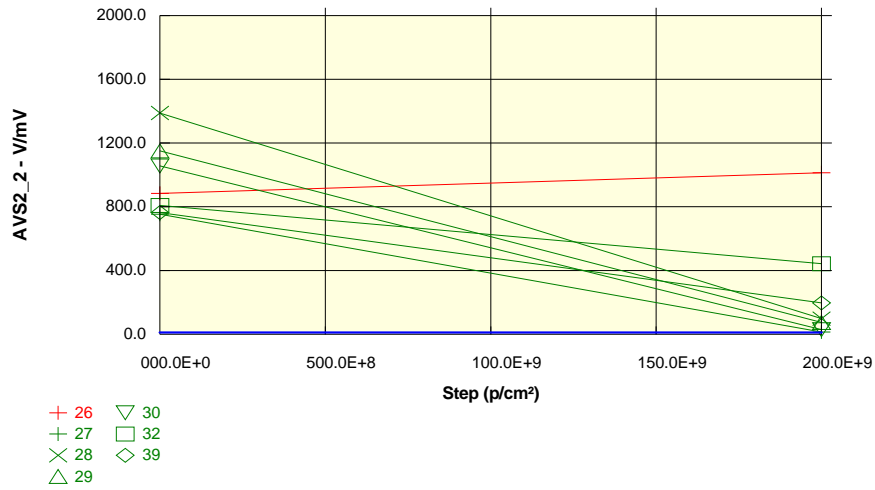

Measurements

AVS2_2DUTD	0 p/cm ²	2E+11 p/cm ²
26_REF	884.4	1013.5
OFF samples		
27	753.0	14.0
28	1388.9	98.2
29	1150.3	73.8
30	1056.3	29.1
32	808.2	442.3
39	763.7	196.7
Statistics		
Min	753.0	14.0
Max	1388.9	442.3
Average	986.8	142.4
Sigma	234.4	146.6

Drift Calculation

AVS2_2DUTD	0 p/cm ²	2E+11 p/cm ²
OFF samples		
27	-	-739.03E+00
28	-	-1.29E+03
29	-	-1.08E+03
30	-	-1.03E+03
32	-	-365.89E+00
39	-	-567.00E+00
Average	-	-844.40E+00
Sigma	-	317.16E+00

Hirex Engineering	Protons Test Report		Ref.:	HRX/TID/0934
	LM124AJRQMLV	National Semiconductors	Issue:	01

Test conditions : Protons

Parameter : Logical "0" output voltage : VOL1DUTA

+VCC=30V. -VCC=GND. RL=10 kO

Unit : V

Spec Limit Max : 35.0E-03

Spec limits are represented in bold lines on the graphic.

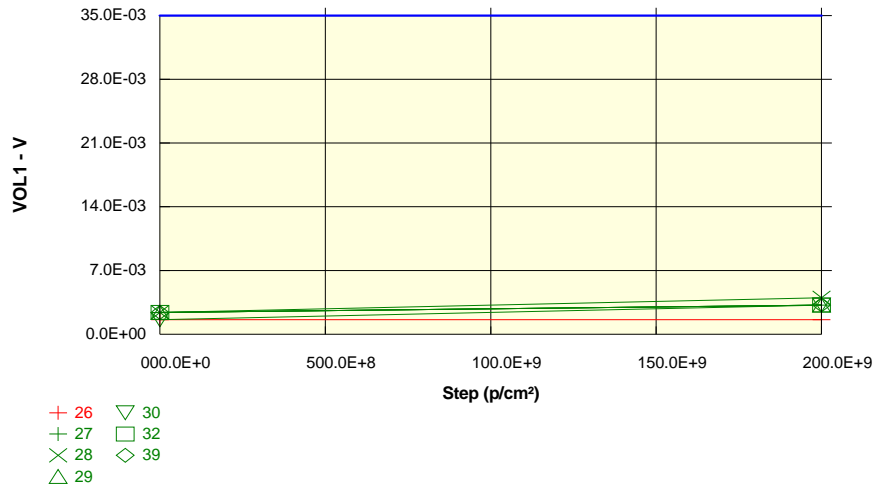

Measurements		
VOL1DUTA	0 p/cm ²	2E+11 p/cm ²
26 REF	1.6E-03	1.6E-03
OFF samples		
27	2.4E-03	3.2E-03
28	2.4E-03	4.0E-03
29	2.4E-03	3.2E-03
30	1.6E-03	3.2E-03
32	2.4E-03	3.2E-03
39	2.4E-03	3.2E-03
Statistics		
Min	1.6E-03	3.2E-03
Max	2.4E-03	4.0E-03
Average	2.3E-03	3.3E-03
Sigma	298.1E-06	298.1E-06

Drift Calculation		
VOL1DUTA	0 p/cm ²	2E+11 p/cm ²
OFF samples		
27	-	800.00E-06
28	-	1.60E-03
29	-	800.00E-06
30	-	1.60E-03
32	-	800.00E-06
39	-	800.00E-06
Average	-	1.07E-03
Sigma	-	377.12E-06

Hirex Engineering	Protons Test Report		Ref.:	HRX/TID/0934
	LM124AJRQLV	National Semiconductors	Issue:	01

Test conditions : Protons

Parameter : Logical "0" output voltage : VOL1DUTB

+VCC=30V. -VCC=GND. RL=10 kO

Unit : V

Spec Limit Max : 35.0E-03

Spec limits are represented in bold lines on the graphic.

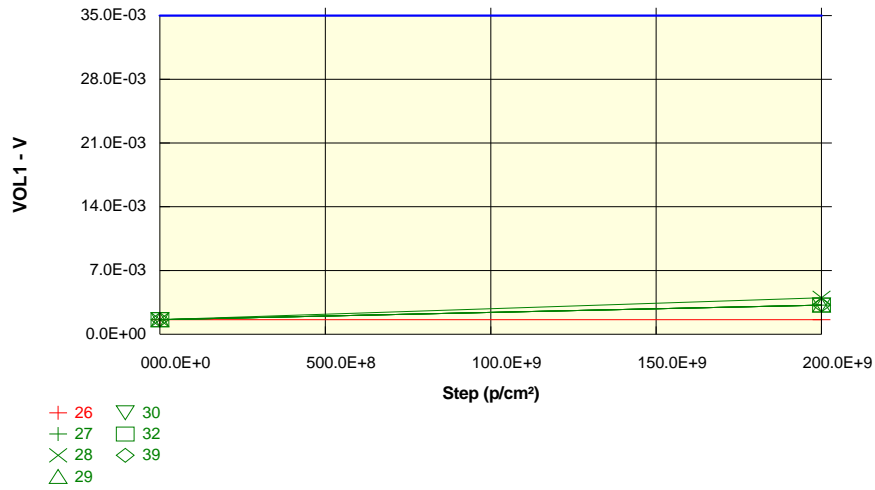

Measurements

VOL1DUTB	0 p/cm²	2E+11 p/cm²
26_REF	1.6E-03	1.6E-03
OFF samples		
27	1.6E-03	3.2E-03
28	1.6E-03	4.0E-03
29	1.6E-03	3.2E-03
30	1.6E-03	3.2E-03
32	1.6E-03	3.2E-03
39	1.6E-03	3.2E-03
Statistics		
Min	1.6E-03	3.2E-03
Max	1.6E-03	4.0E-03
Average	1.6E-03	3.3E-03
Sigma	16.8E-12	298.1E-06

Drift Calculation

VOL1DUTB	0 p/cm²	2E+11 p/cm²
OFF samples		
27	-	1.60E-03
28	-	2.40E-03
29	-	1.60E-03
30	-	1.60E-03
32	-	1.60E-03
39	-	1.60E-03
Average	-	1.73E-03
Sigma	-	298.14E-06

Hirex Engineering	Protons Test Report		Ref.:	HRX/TID/0934
	LM124AJRQLV	National Semiconductors	Issue:	01

Test conditions : Protons

Parameter : Logical "0" output voltage : VOL1DUTC

+VCC=30V. -VCC=GND. RL=10 kO

Unit : V

Spec Limit Max : 35.0E-03

Spec limits are represented in bold lines on the graphic.

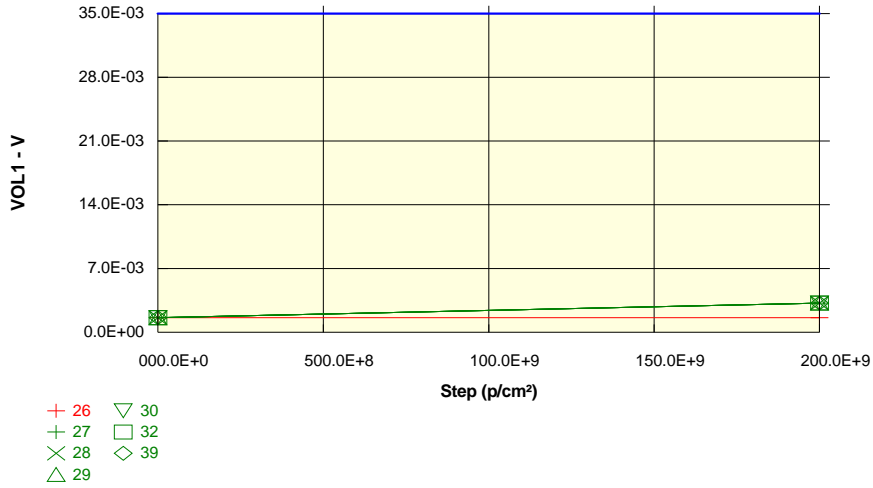

Measurements

VOL1DUTC	0 p/cm²	2E+11 p/cm²
26_REF	1.6E-03	1.6E-03
OFF samples		
27	1.6E-03	3.2E-03
28	1.6E-03	3.2E-03
29	1.6E-03	3.2E-03
30	1.6E-03	3.2E-03
32	1.6E-03	3.2E-03
39	1.6E-03	3.2E-03
Statistics		
Min	1.6E-03	3.2E-03
Max	1.6E-03	3.2E-03
Average	1.6E-03	3.2E-03
Sigma	16.8E-12	33.6E-12

Drift Calculation

VOL1DUTC	0 p/cm²	2E+11 p/cm²
OFF samples		
27	-	1.60E-03
28	-	1.60E-03
29	-	1.60E-03
30	-	1.60E-03
32	-	1.60E-03
39	-	1.60E-03
Average	-	1.60E-03
Sigma	-	16.80E-12

Hirex Engineering	Protons Test Report		Ref.:	HRX/TID/0934
	LM124AJRQLV	National Semiconductors	Issue:	01

Test conditions : Protons

Parameter : Logical "0" output voltage : VOL1DUTD

+VCC=30V. -VCC=GND. RL=10 kO

Unit : V

Spec Limit Max : 35.0E-03

Spec limits are represented in bold lines on the graphic.

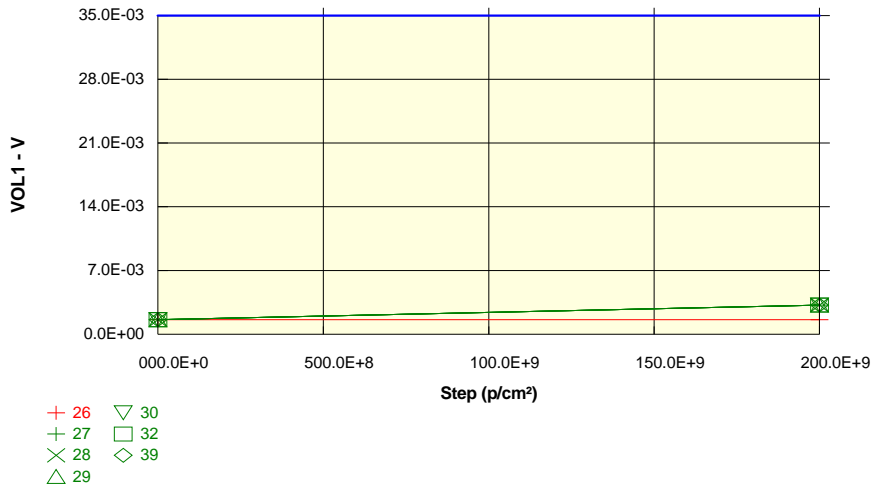

Measurements

VOL1DUTD	0 p/cm²	2E+11 p/cm²
26_REF	1.6E-03	1.6E-03
OFF samples		
27	1.6E-03	3.2E-03
28	1.6E-03	3.2E-03
29	1.6E-03	3.2E-03
30	1.6E-03	3.2E-03
32	1.6E-03	3.2E-03
39	1.6E-03	3.2E-03
Statistics		
Min	1.6E-03	3.2E-03
Max	1.6E-03	3.2E-03
Average	1.6E-03	3.2E-03
Sigma	16.8E-12	33.6E-12

Drift Calculation

VOL1DUTD	0 p/cm²	2E+11 p/cm²
OFF samples		
27	-	1.60E-03
28	-	1.60E-03
29	-	1.60E-03
30	-	1.60E-03
32	-	1.60E-03
39	-	1.60E-03
Average	-	1.60E-03
Sigma	-	16.80E-12

Hirex Engineering	Protons Test Report		Ref.:	HRX/TID/0934
	LM124AJRQLV	National Semiconductors	Issue:	01

Test conditions : Protons

Parameter : Logical "0" output voltage : VOL2DUTA

+VCC=30V. -VCC=GND. IOL=5mA

Unit : V

Spec Limit Max : 1.5E+00

Spec limits are represented in bold lines on the graphic.

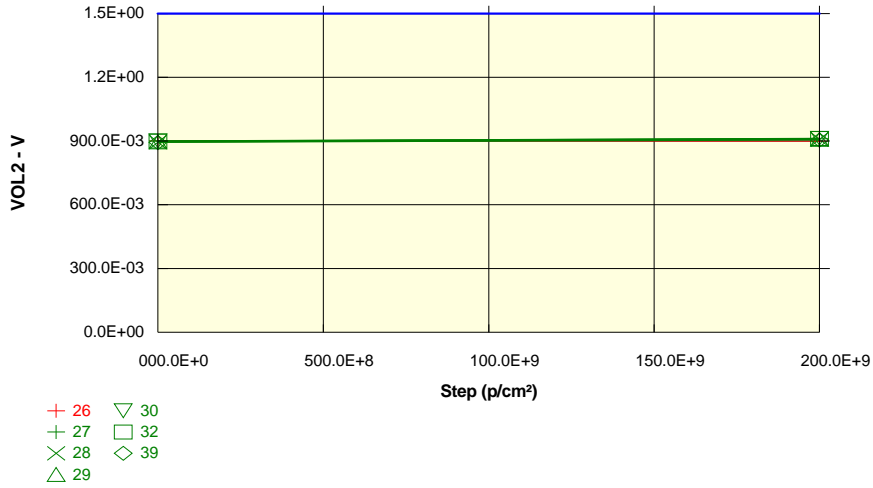

Measurements

VOL2DUTA	0 p/cm ²	2E+11 p/cm ²
26 REF	900.8E-03	899.2E-03
OFF samples		
27	899.2E-03	910.4E-03
28	895.2E-03	908.0E-03
29	896.0E-03	908.0E-03
30	900.8E-03	912.8E-03
32	900.0E-03	912.0E-03
39	892.8E-03	904.8E-03
Statistics		
Min	892.8E-03	904.8E-03
Max	900.8E-03	912.8E-03
Average	897.3E-03	909.3E-03
Sigma	2.9E-03	2.7E-03

Drift Calculation

VOL2DUTA	0 p/cm ²	2E+11 p/cm ²
OFF samples		
27	-	11.20E-03
28	-	12.80E-03
29	-	12.00E-03
30	-	12.00E-03
32	-	12.00E-03
39	-	12.00E-03
Average	-	12.00E-03
Sigma	-	461.89E-06

Hirex Engineering	Protons Test Report		Ref.:	HRX/TID/0934
	LM124AJRQLV	National Semiconductors	Issue:	01

Test conditions : Protons

Parameter : Logical "0" output voltage : VOL2DUTB

+VCC=30V. -VCC=GND. IOL=5mA

Unit : V

Spec Limit Max : 1.5E+00

Spec limits are represented in bold lines on the graphic.

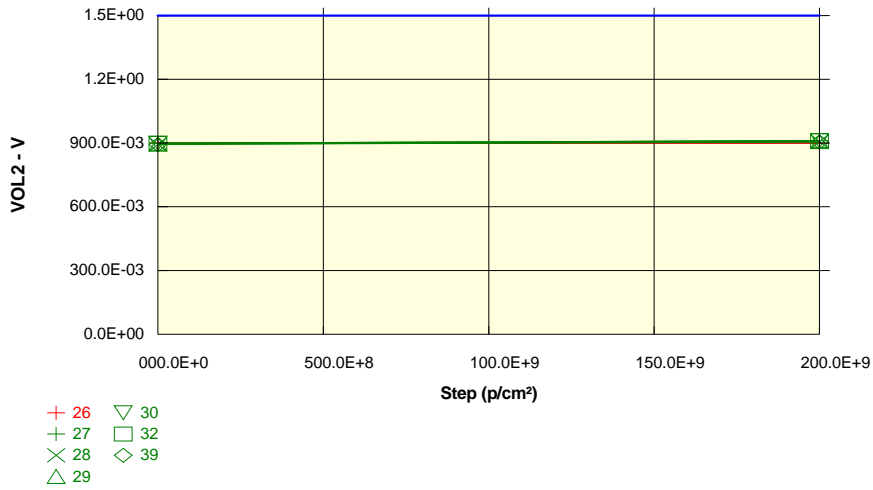

Measurements

VOL2DUTB	0 p/cm ²	2E+11 p/cm ²
26 REF	900.0E-03	898.4E-03
OFF samples		
27	898.4E-03	910.4E-03
28	894.4E-03	907.2E-03
29	895.2E-03	907.2E-03
30	899.2E-03	911.2E-03
32	899.2E-03	911.2E-03
39	892.8E-03	904.8E-03
Statistics		
Min	892.8E-03	904.8E-03
Max	899.2E-03	911.2E-03
Average	896.5E-03	908.7E-03
Sigma	2.5E-03	2.4E-03

Drift Calculation

VOL2DUTB	0 p/cm ²	2E+11 p/cm ²
OFF samples		
27	-	12.00E-03
28	-	12.80E-03
29	-	12.00E-03
30	-	12.00E-03
32	-	12.00E-03
39	-	12.00E-03
Average	-	12.13E-03
Sigma	-	298.14E-06

Hirex Engineering	Protons Test Report		Ref.:	HRX/TID/0934
	LM124AJRQLV	National Semiconductors	Issue:	01

Test conditions : Protons

Parameter : Logical "0" output voltage : VOL2DUTC

+VCC=30V. -VCC=GND. IOL=5mA

Unit : V

Spec Limit Max : 1.5E+00

Spec limits are represented in bold lines on the graphic.

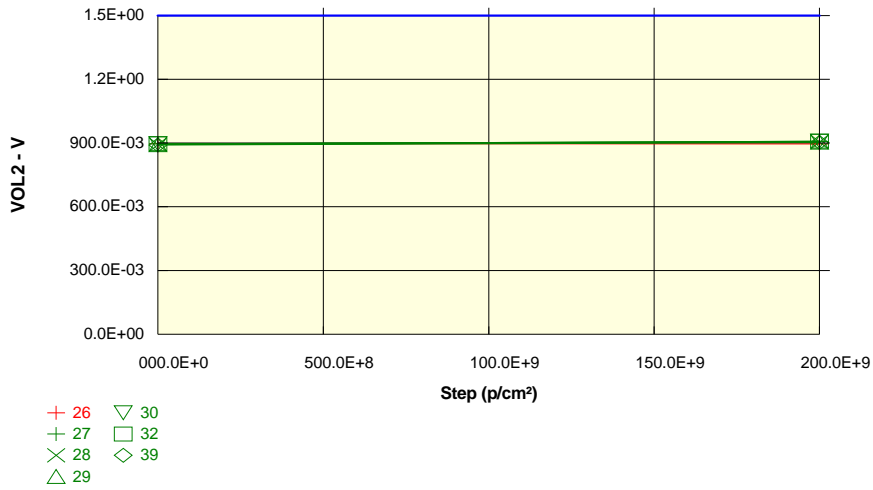

Measurements

VOL2DUTC	0 p/cm ²	2E+11 p/cm ²
26 REF	897.6E-03	896.0E-03
OFF samples		
27	896.0E-03	907.2E-03
28	892.0E-03	904.8E-03
29	892.8E-03	904.8E-03
30	896.8E-03	908.8E-03
32	896.8E-03	908.8E-03
39	890.4E-03	902.4E-03
Statistics		
Min	890.4E-03	902.4E-03
Max	896.8E-03	908.8E-03
Average	894.1E-03	906.1E-03
Sigma	2.5E-03	2.3E-03

Drift Calculation

VOL2DUTC	0 p/cm ²	2E+11 p/cm ²
OFF samples		
27	-	11.20E-03
28	-	12.80E-03
29	-	12.00E-03
30	-	12.00E-03
32	-	12.00E-03
39	-	12.00E-03
Average	-	12.00E-03
Sigma	-	461.89E-06

Hirex Engineering	Protons Test Report		Ref.:	HRX/TID/0934
	LM124AJRQMLV	National Semiconductors	Issue:	01

Test conditions : Protons

Parameter : Logical "0" output voltage : VOL2DUTD

+VCC=30V. -VCC=GND. IOL=5mA

Unit : V

Spec Limit Max : 1.5E+00

Spec limits are represented in bold lines on the graphic.

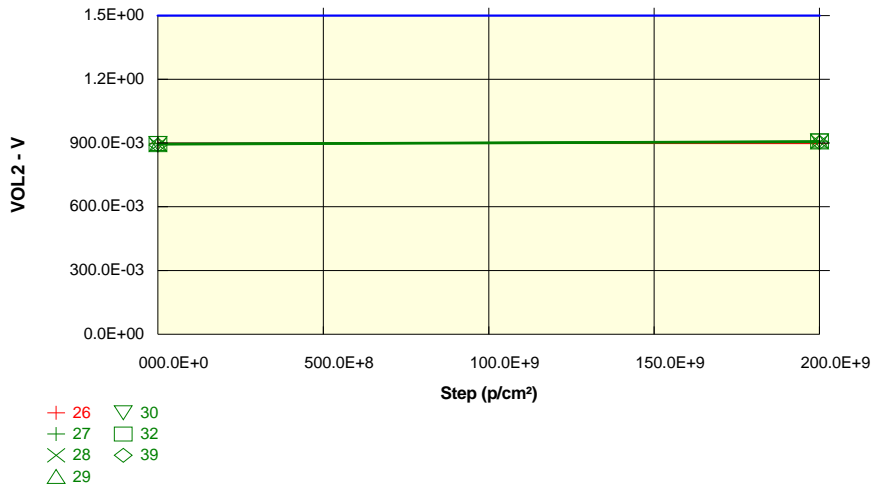

Measurements

VOL2DUTD	0 p/cm ²	2E+11 p/cm ²
26 REF	898.4E-03	897.6E-03
OFF samples		
27	896.8E-03	908.8E-03
28	892.0E-03	905.6E-03
29	892.8E-03	905.6E-03
30	898.4E-03	910.4E-03
32	897.6E-03	909.6E-03
39	890.4E-03	902.4E-03
Statistics		
Min	890.4E-03	902.4E-03
Max	898.4E-03	910.4E-03
Average	894.7E-03	907.1E-03
Sigma	3.1E-03	2.8E-03

Drift Calculation

VOL2DUTD	0 p/cm ²	2E+11 p/cm ²
OFF samples		
27	-	12.00E-03
28	-	13.60E-03
29	-	12.80E-03
30	-	12.00E-03
32	-	12.00E-03
39	-	12.00E-03
Average	-	12.40E-03
Sigma	-	611.01E-06

Hirex Engineering	Protons Test Report		Ref.:	HRX/TID/0934
	LM124AJRQLV	National Semiconductors	Issue:	01

Test conditions : Protons

Parameter : Logical "0" output voltage : VOL3DUTA

+VCC=4.5V. -VCC=GND. IOL=2µA

Unit : V

Spec Limit Max : 400.0E-03

Spec limits are represented in bold lines on the graphic.

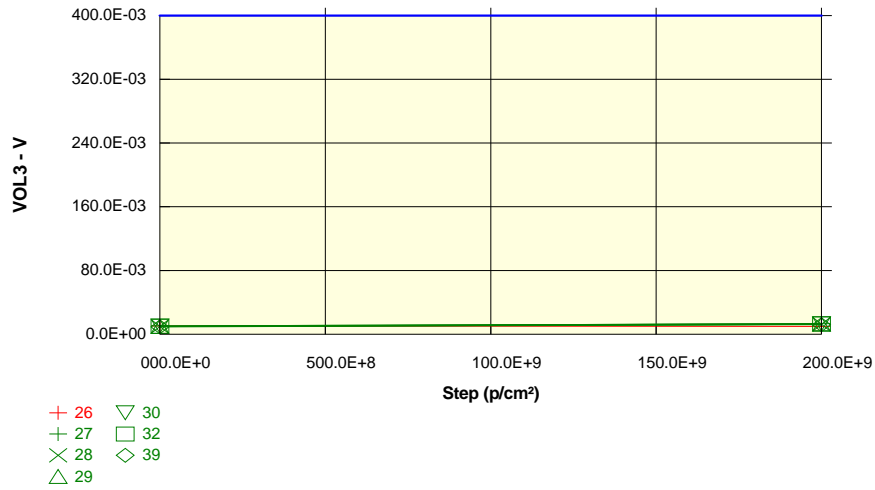

Measurements

VOL3DUTA	0 p/cm²	2E+11 p/cm²
26 REF	10.4E-03	10.0E-03
OFF samples		
27	10.4E-03	13.2E-03
28	9.6E-03	12.4E-03
29	9.6E-03	12.4E-03
30	10.4E-03	13.2E-03
32	10.0E-03	13.2E-03
39	9.2E-03	12.0E-03
Statistics		
Min	9.2E-03	12.0E-03
Max	10.4E-03	13.2E-03
Average	9.9E-03	12.7E-03
Sigma	442.2E-06	485.3E-06

Drift Calculation

VOL3DUTA	0 p/cm²	2E+11 p/cm²
OFF samples		
27	-	2.80E-03
28	-	2.80E-03
29	-	2.80E-03
30	-	2.80E-03
32	-	3.20E-03
39	-	2.80E-03
Average	-	2.87E-03
Sigma	-	149.07E-06

Hirex Engineering	Protons Test Report		Ref.:	HRX/TID/0934
	LM124AJRQLV	National Semiconductors	Issue:	01

Test conditions : Protons

Parameter : Logical "0" output voltage : VOL3DUTB

+VCC=4.5V. -VCC=GND. IOL=2µA

Unit : V

Spec Limit Max : 400.0E-03

Spec limits are represented in bold lines on the graphic.

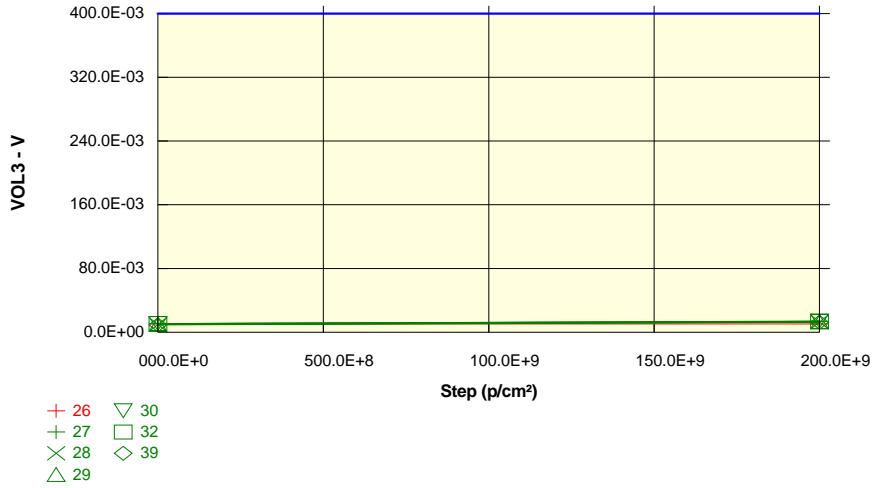

Measurements

VOL3DUTB	0 p/cm²	2E+11 p/cm²
26_REF	10.4E-03	10.4E-03
OFF samples		
27	10.8E-03	13.6E-03
28	9.6E-03	12.8E-03
29	9.6E-03	12.8E-03
30	10.8E-03	14.0E-03
32	10.8E-03	13.6E-03
39	9.2E-03	12.4E-03
Statistics		
Min	9.2E-03	12.4E-03
Max	10.8E-03	14.0E-03
Average	10.1E-03	13.2E-03
Sigma	679.9E-06	565.7E-06

Drift Calculation

VOL3DUTB	0 p/cm²	2E+11 p/cm²
OFF samples		
27	-	2.80E-03
28	-	3.20E-03
29	-	3.20E-03
30	-	3.20E-03
32	-	2.80E-03
39	-	3.20E-03
Average	-	3.07E-03
Sigma	-	188.56E-06

Hirex Engineering	Protons Test Report		Ref.:	HRX/TID/0934
	LM124AJRQLV	National Semiconductors	Issue:	01

Test conditions : Protons

Parameter : Logical "0" output voltage : VOL3DUTC

+VCC=4.5V. -VCC=GND. IOL=2µA

Unit : V

Spec Limit Max : 400.0E-03

Spec limits are represented in bold lines on the graphic.

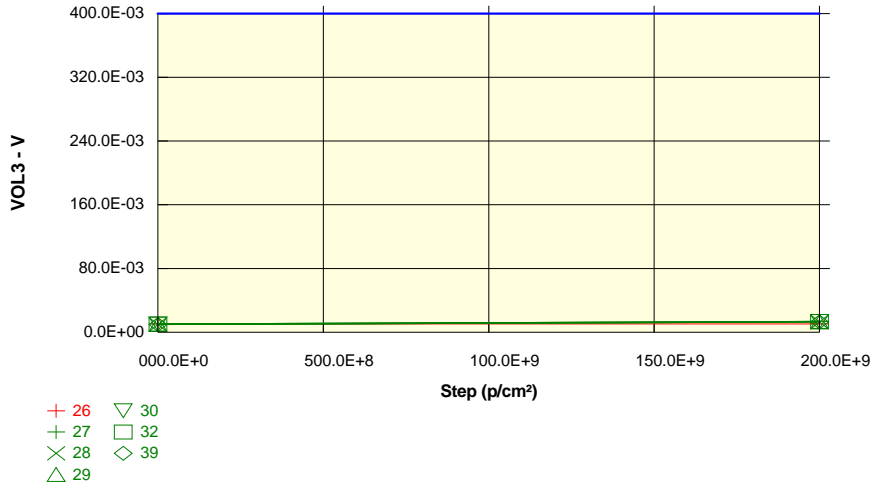

Measurements

VOL3DUTC	0 p/cm²	2E+11 p/cm²
26 REF	10.4E-03	10.4E-03
OFF samples		
27	10.4E-03	13.6E-03
28	9.6E-03	12.8E-03
29	9.6E-03	12.8E-03
30	10.4E-03	13.6E-03
32	10.4E-03	13.6E-03
39	9.6E-03	12.8E-03
Statistics		
Min	9.6E-03	12.8E-03
Max	10.4E-03	13.6E-03
Average	10.0E-03	13.2E-03
Sigma	400.0E-06	400.0E-06

Drift Calculation

VOL3DUTC	0 p/cm²	2E+11 p/cm²
OFF samples		
27	-	3.20E-03
28	-	3.20E-03
29	-	3.20E-03
30	-	3.20E-03
32	-	3.20E-03
39	-	3.20E-03
Average	-	3.20E-03
Sigma	-	462.01E-12

Test conditions : Protons

Parameter : Logical "0" output voltage : VOL3DUTD

+VCC=4.5V. -VCC=GND. IOL=2µA

Unit : V

Spec Limit Max : 400.0E-03

Spec limits are represented in bold lines on the graphic.

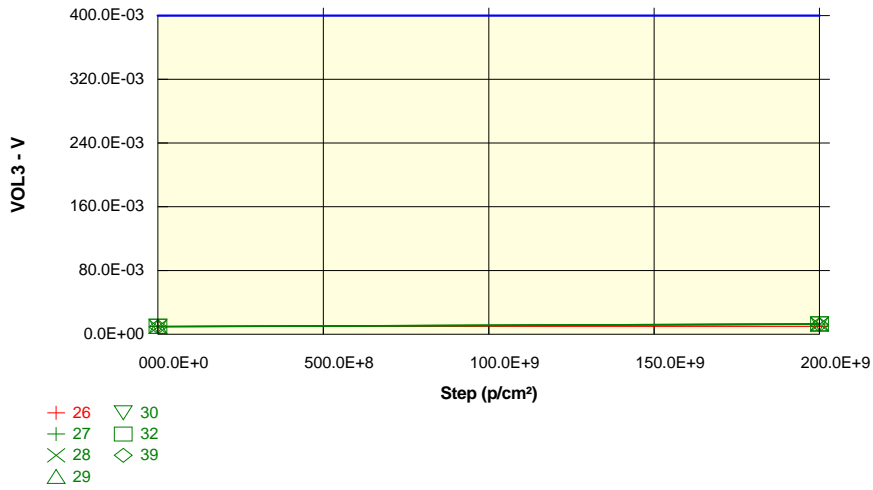

Measurements

VOL3DUTD	0 p/cm²	2E+11 p/cm²
26 REF	10.0E-03	10.0E-03
OFF samples		
27	10.0E-03	12.8E-03
28	9.2E-03	12.4E-03
29	9.6E-03	12.4E-03
30	10.0E-03	13.2E-03
32	10.0E-03	13.2E-03
39	9.2E-03	12.0E-03
Statistics		
Min	9.2E-03	12.0E-03
Max	10.0E-03	13.2E-03
Average	9.7E-03	12.7E-03
Sigma	359.0E-06	442.2E-06

Drift Calculation

VOL3DUTD	0 p/cm²	2E+11 p/cm²
OFF samples		
27	-	2.80E-03
28	-	3.20E-03
29	-	2.80E-03
30	-	3.20E-03
32	-	3.20E-03
39	-	2.80E-03
Average	-	3.00E-03
Sigma	-	200.00E-06

Hirex Engineering	Protons Test Report		Ref.:	HRX/TID/0934
	LM124AJRQMLV	National Semiconductors	Issue:	01

Test conditions : Protons

Parameter : Logical "1" output voltage : VOH1DUTA

+VCC=30 V. -VCC=GND. IOH=-10mA

Unit : V

Spec Limit Min : 27.00

Spec limits are represented in bold lines on the graphic.

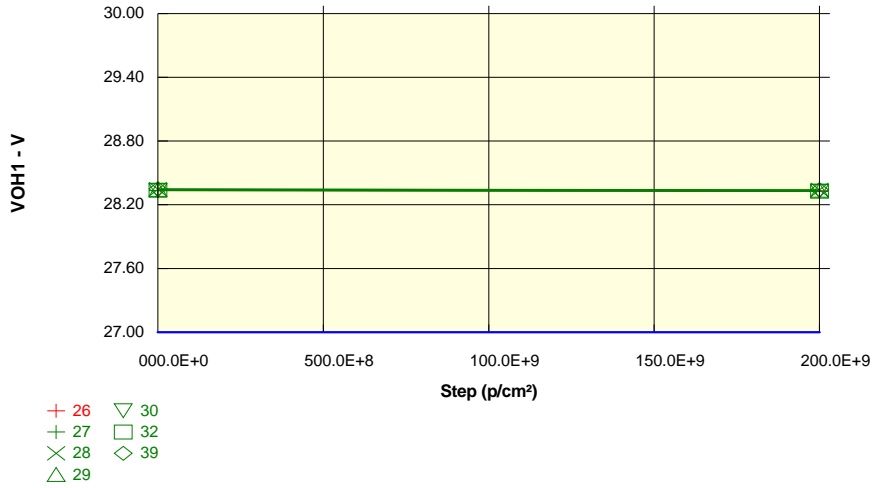

Measurements

VOH1DUTA	0 p/cm²	2E+11 p/cm²
26_REF	28.33	28.33
OFF samples		
27	28.33	28.33
28	28.35	28.34
29	28.34	28.34
30	28.33	28.33
32	28.34	28.33
39	28.35	28.34
Statistics		
Min	28.33	28.33
Max	28.35	28.34
Average	28.34	28.33
Sigma	0.01	0.01

Drift Calculation

VOH1DUTA	0 p/cm²	2E+11 p/cm²
OFF samples		
27	-	-8.00E-03
28	-	-8.00E-03
29	-	-8.00E-03
30	-	-8.00E-03
32	-	-8.00E-03
39	-	-7.20E-03
Average	-	-7.87E-03
Sigma	-	298.26E-06

Hirex Engineering	Protons Test Report		Ref.:	HRX/TID/0934
	LM124AJRQMLV	National Semiconductors	Issue:	01

Test conditions : Protons

Parameter : Logical "1" output voltage : VOH1DUTB

+VCC=30 V. -VCC=GND. IOH=-10mA

Unit : V

Spec Limit Min : 27.00

Spec limits are represented in bold lines on the graphic.

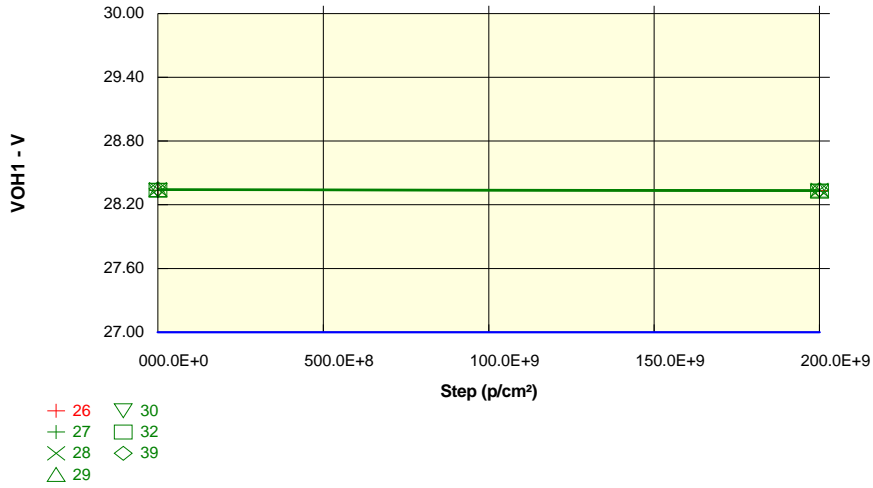

Measurements

VOH1DUTB	0 p/cm²	2E+11 p/cm²
26_REF	28.34	28.33
OFF samples		
27	28.34	28.33
28	28.35	28.34
29	28.34	28.34
30	28.34	28.33
32	28.34	28.33
39	28.35	28.34
Statistics		
Min	28.34	28.33
Max	28.35	28.34
Average	28.34	28.33
Sigma	0.01	0.01

Drift Calculation

VOH1DUTB	0 p/cm²	2E+11 p/cm²
OFF samples		
27	-	-8.00E-03
28	-	-8.00E-03
29	-	-8.00E-03
30	-	-7.20E-03
32	-	-8.80E-03
39	-	-7.20E-03
Average	-	-7.87E-03
Sigma	-	549.88E-06

Hirex Engineering	Protons Test Report		Ref.:	HRX/TID/0934
	LM124AJRQMLV	National Semiconductors	Issue:	01

Test conditions : Protons

Parameter : Logical "1" output voltage : VOH1DUTC

+VCC=30 V. -VCC=GND. IOH=-10mA

Unit : V

Spec Limit Min : 27.00

Spec limits are represented in bold lines on the graphic.

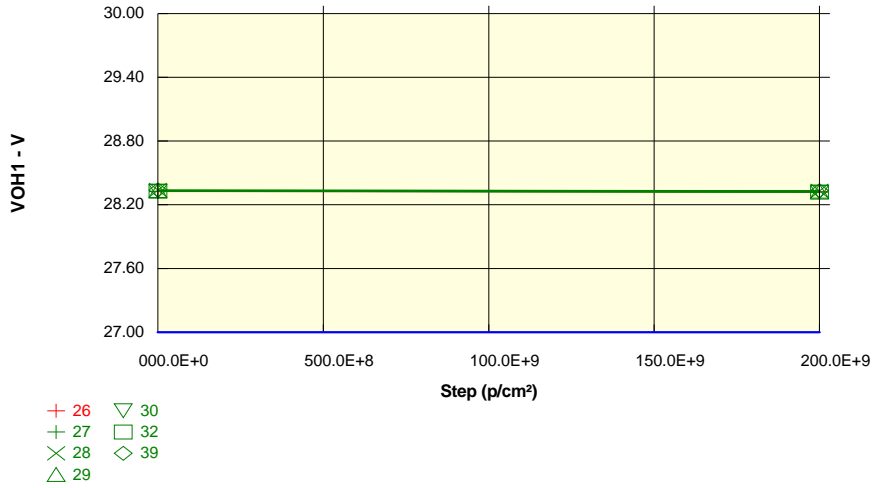

Measurements

VOH1DUTC	0 p/cm²	2E+11 p/cm²
26_REF	28.32	28.32
OFF samples		
27	28.33	28.32
28	28.34	28.33
29	28.34	28.33
30	28.33	28.32
32	28.33	28.32
39	28.34	28.33
Statistics		
Min	28.33	28.32
Max	28.34	28.33
Average	28.33	28.32
Sigma	0.01	0.01

Drift Calculation

VOH1DUTC	0 p/cm²	2E+11 p/cm²
OFF samples		
27	-	-8.00E-03
28	-	-8.00E-03
29	-	-8.00E-03
30	-	-8.00E-03
32	-	-8.00E-03
39	-	-7.20E-03
Average	-	-7.87E-03
Sigma	-	297.84E-06

Hirex Engineering	Protons Test Report		Ref.:	HRX/TID/0934
	LM124AJRQMLV	National Semiconductors	Issue:	01

Test conditions : Protons

Parameter : Logical "1" output voltage : VOH1DUTD

+VCC=30 V. -VCC=GND. IOH=-10mA

Unit : V

Spec Limit Min : 27.00

Spec limits are represented in bold lines on the graphic.

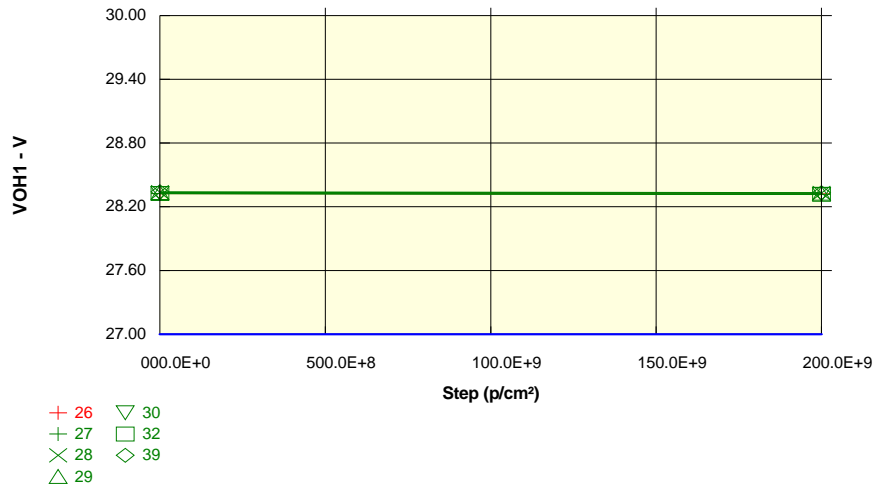

Measurements

VOH1DUTD	0 p/cm²	2E+11 p/cm²
26_REF	28.32	28.32
OFF samples		
27	28.32	28.32
28	28.34	28.33
29	28.34	28.33
30	28.32	28.32
32	28.32	28.32
39	28.34	28.33
Statistics		
Min	28.32	28.32
Max	28.34	28.33
Average	28.33	28.32
Sigma	0.01	0.01

Drift Calculation

VOH1DUTD	0 p/cm²	2E+11 p/cm²
OFF samples		
27	-	-8.00E-03
28	-	-8.00E-03
29	-	-8.00E-03
30	-	-8.00E-03
32	-	-8.00E-03
39	-	-7.20E-03
Average	-	-7.87E-03
Sigma	-	298.12E-06

Test conditions : Protons

Parameter : Logical "1" output voltage : VOH2DUTA

+VCC=4.5V. -VCC=GND. IOH=-10mA

Unit : V

Spec Limit Min : 2.40

Spec limits are represented in bold lines on the graphic.

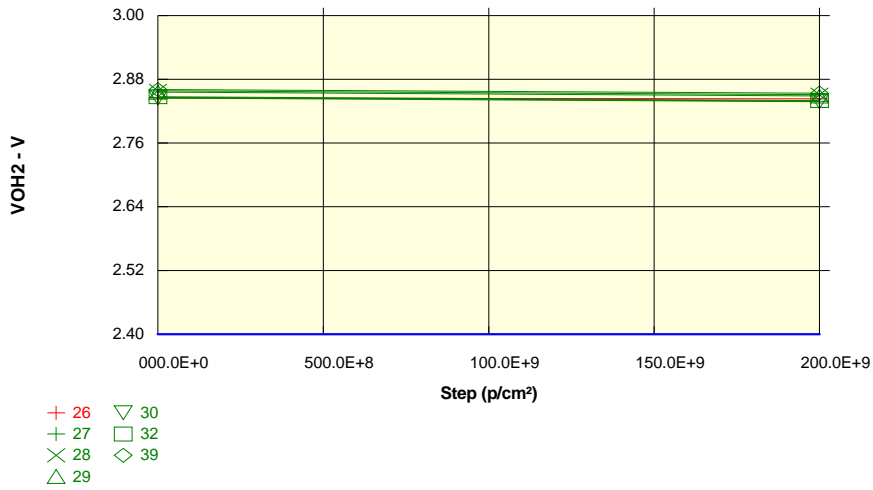

Measurements

VOH2DUTA	0 p/cm ²	2E+11 p/cm ²
26_REF	2.84	2.84
OFF samples		
27	2.85	2.84
28	2.86	2.85
29	2.86	2.85
30	2.84	2.84
32	2.85	2.84
39	2.86	2.85
Statistics		
Min	2.84	2.84
Max	2.86	2.85
Average	2.85	2.85
Sigma	0.01	0.01

Drift Calculation

VOH2DUTA	0 p/cm ²	2E+11 p/cm ²
OFF samples		
27	-	-7.20E-03
28	-	-7.20E-03
29	-	-7.20E-03
30	-	-6.80E-03
32	-	-7.20E-03
39	-	-6.80E-03
Average	-	-7.07E-03
Sigma	-	188.59E-06

Hirex Engineering	Protons Test Report		Ref.:	HRX/TID/0934
	LM124AJRQMLV	National Semiconductors	Issue:	01

Test conditions : Protons

Parameter : Logical "1" output voltage : VOH2DUTB

+VCC=4.5V. -VCC=GND. IOH=-10mA

Unit : V

Spec Limit Min : 2.40

Spec limits are represented in bold lines on the graphic.

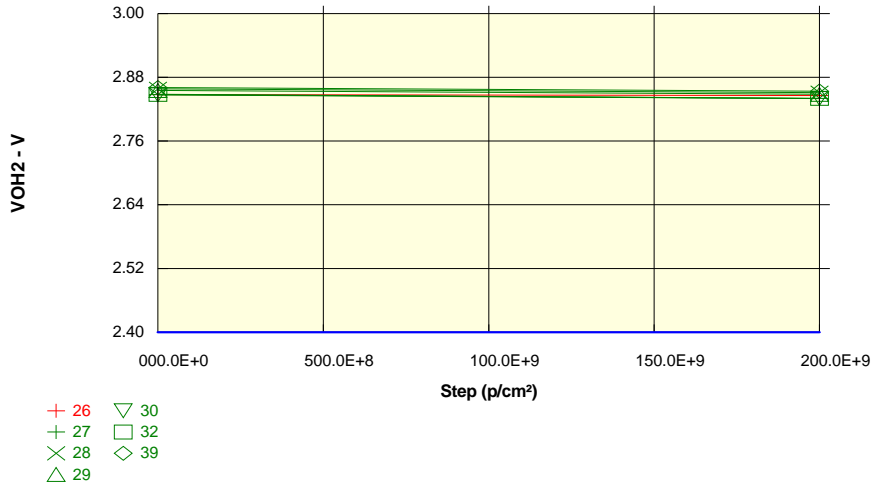

Measurements

VOH2DUTB	0 p/cm²	2E+11 p/cm²
26_REF	2.85	2.85
OFF samples		
27	2.85	2.84
28	2.86	2.85
29	2.86	2.85
30	2.85	2.84
32	2.85	2.84
39	2.86	2.85
Statistics		
Min	2.85	2.84
Max	2.86	2.85
Average	2.85	2.85
Sigma	0.01	0.01

Drift Calculation

VOH2DUTB	0 p/cm²	2E+11 p/cm²
OFF samples		
27	-	-7.20E-03
28	-	-7.20E-03
29	-	-7.20E-03
30	-	-6.80E-03
32	-	-7.60E-03
39	-	-6.80E-03
Average	-	-7.13E-03
Sigma	-	274.87E-06

Test conditions : Protons

Parameter : Logical "1" output voltage : VOH2DUTC

+VCC=4.5V. -VCC=GND. IOH=-10mA

Unit : V

Spec Limit Min : 2.40

Spec limits are represented in bold lines on the graphic.

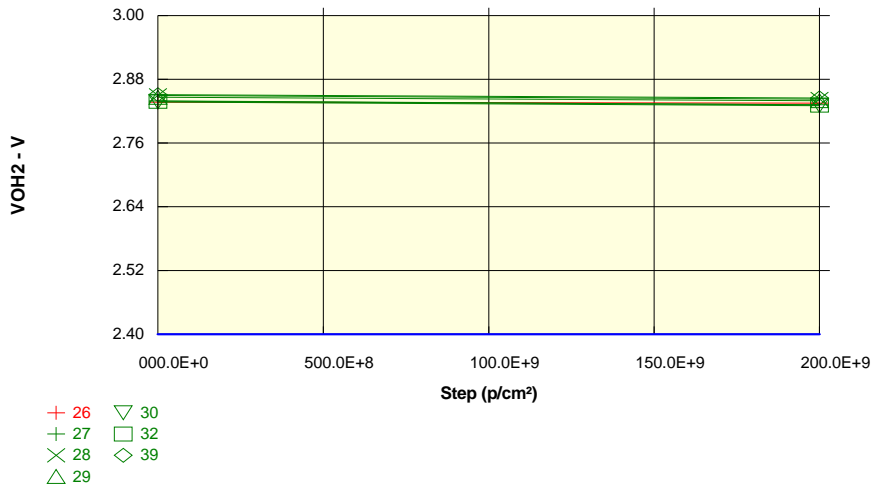

Measurements

VOH2DUTC	0 p/cm²	2E+11 p/cm²
26_REF	2.84	2.84
OFF samples		
27	2.84	2.83
28	2.85	2.84
29	2.85	2.84
30	2.84	2.83
32	2.84	2.83
39	2.85	2.84
Statistics		
Min	2.84	2.83
Max	2.85	2.84
Average	2.84	2.84
Sigma	0.01	0.01

Drift Calculation

VOH2DUTC	0 p/cm²	2E+11 p/cm²
OFF samples		
27	-	-7.20E-03
28	-	-6.80E-03
29	-	-6.80E-03
30	-	-6.80E-03
32	-	-7.20E-03
39	-	-6.40E-03
Average	-	-6.87E-03
Sigma	-	274.84E-06

Hirex Engineering	Protons Test Report		Ref.:	HRX/TID/0934
	LM124AJRQMLV	National Semiconductors	Issue:	01

Test conditions : Protons

Parameter : Logical "1" output voltage : VOH2DUTD

+VCC=4.5V. -VCC=GND. IOH=-10mA

Unit : V

Spec Limit Min : 2.40

Spec limits are represented in bold lines on the graphic.

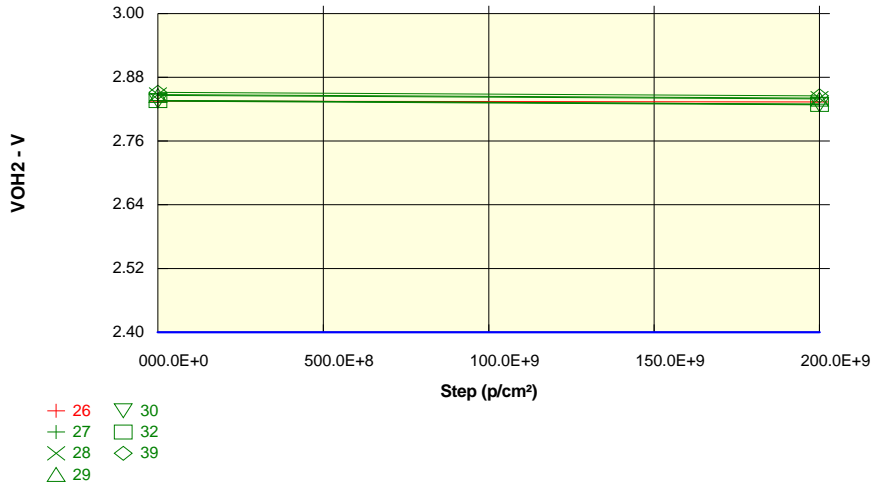

Measurements		
VOH2DUTD	0 p/cm ²	2E+11 p/cm ²
26_REF	2.84	2.83
OFF samples		
27	2.84	2.83
28	2.85	2.84
29	2.85	2.84
30	2.84	2.83
32	2.84	2.83
39	2.85	2.85
Statistics		
Min	2.84	2.83
Max	2.85	2.85
Average	2.84	2.84
Sigma	0.01	0.01

Drift Calculation		
VOH2DUTD	0 p/cm ²	2E+11 p/cm ²
OFF samples		
27	-	-7.20E-03
28	-	-6.80E-03
29	-	-6.80E-03
30	-	-6.80E-03
32	-	-7.20E-03
39	-	-6.40E-03
Average	-	-6.87E-03
Sigma	-	274.91E-06

Hirex Engineering	Protons Test Report		Ref.:	HRX/TID/0934
	LM124AJRQLV	National Semiconductors	Issue:	01

Test conditions : Protons

Parameter : Maximum Output Voltage Swing : VOP1DUTA

+VCC=30V. -VCC=GND. Vout=30V. RL=10K

Unit : V

Spec Limit Min : 27.00

Spec limits are represented in bold lines on the graphic.

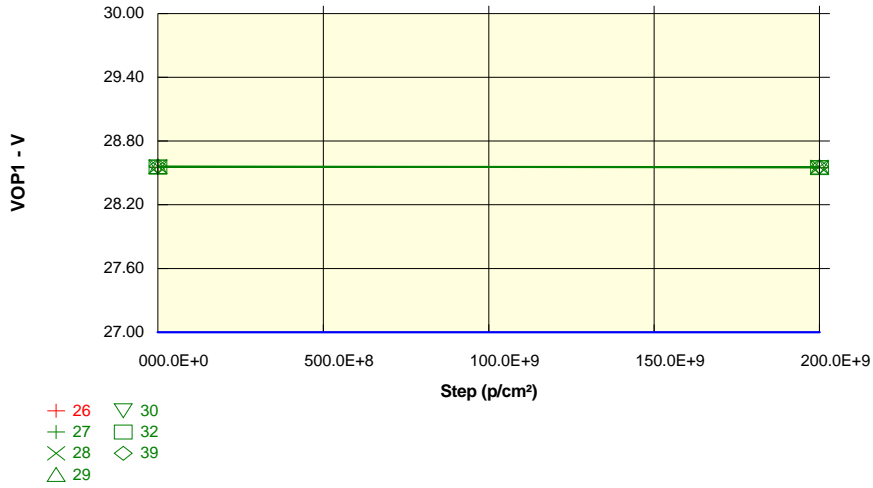

Measurements

VOP1DUTA	0 p/cm ²	2E+11 p/cm ²
26_REF	28.55	28.55
OFF samples		
27	28.55	28.55
28	28.56	28.56
29	28.56	28.56
30	28.55	28.55
32	28.55	28.55
39	28.56	28.56
Statistics		
Min	28.55	28.55
Max	28.56	28.56
Average	28.56	28.55
Sigma	0.00	0.00

Drift Calculation

VOP1DUTA	0 p/cm ²	2E+11 p/cm ²
OFF samples		
27	-	-5.60E-03
28	-	-4.80E-03
29	-	-4.80E-03
30	-	-5.60E-03
32	-	-4.80E-03
39	-	-4.80E-03
Average	-	-5.07E-03
Sigma	-	377.41E-06

Hirex Engineering	Protons Test Report		Ref.:	HRX/TID/0934
	LM124AJRQMLV	National Semiconductors	Issue:	01

Test conditions : Protons

Parameter : Maximum Output Voltage Swing : VOP1DUTB

+VCC=30V. -VCC=GND. Vout=30V. RL=10K

Unit : V

Spec Limit Min : 27.00

Spec limits are represented in bold lines on the graphic.

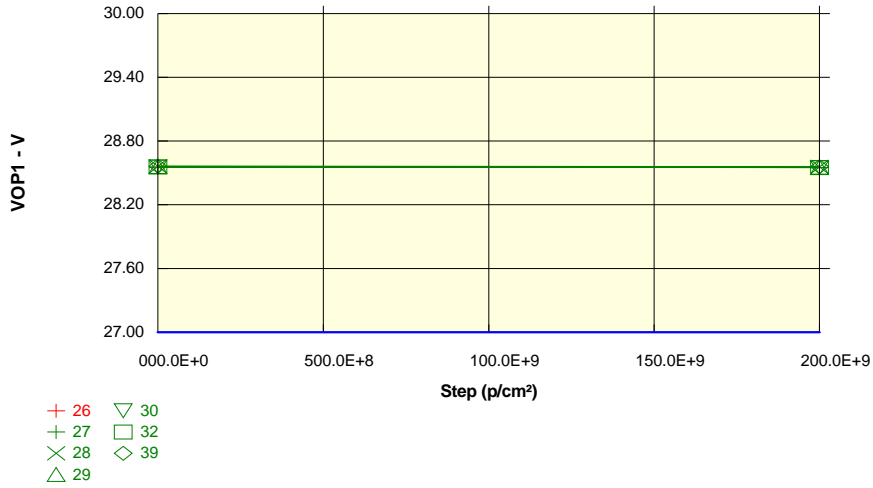

Measurements		
VOP1DUTB	0 p/cm ²	2E+11 p/cm ²
26_REF	28.56	28.55
OFF samples		
27	28.56	28.55
28	28.56	28.56
29	28.56	28.55
30	28.55	28.55
32	28.56	28.55
39	28.56	28.56
Statistics		
Min	28.55	28.55
Max	28.56	28.56
Average	28.56	28.55
Sigma	0.00	0.00

Drift Calculation		
VOP1DUTB	0 p/cm ²	2E+11 p/cm ²
OFF samples		
27	-	-5.60E-03
28	-	-4.80E-03
29	-	-5.60E-03
30	-	-4.80E-03
32	-	-4.80E-03
39	-	-5.60E-03
Average	-	-5.20E-03
Sigma	-	400.23E-06

Hirex Engineering	Protons Test Report		Ref.:	HRX/TID/0934
	LM124AJRQLV	National Semiconductors	Issue:	01

Test conditions : Protons

Parameter : Maximum Output Voltage Swing : VOP1DUTC

+VCC=30V. -VCC=GND. Vout=30V. RL=10K

Unit : V

Spec Limit Min : 27.00

Spec limits are represented in bold lines on the graphic.

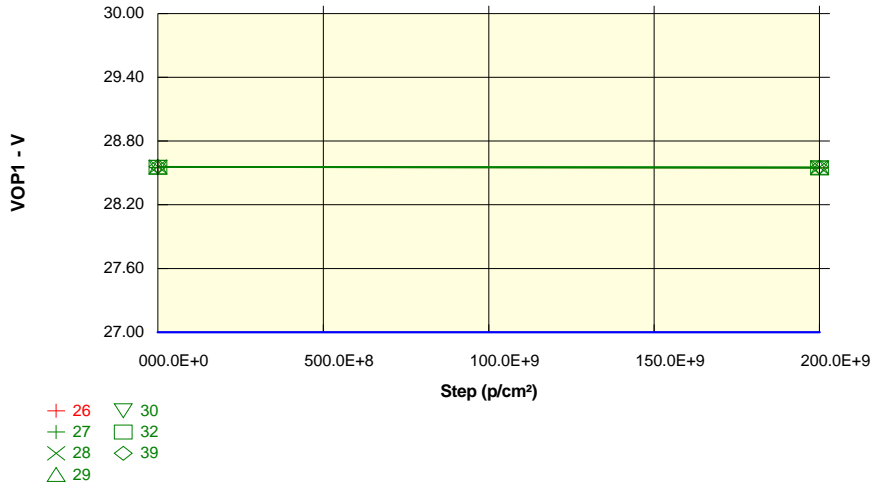

Measurements

VOP1DUTC	0 p/cm ²	2E+11 p/cm ²
26_REF	28.55	28.55
OFF samples		
27	28.55	28.55
28	28.56	28.55
29	28.56	28.55
30	28.55	28.55
32	28.55	28.55
39	28.56	28.56
Statistics		
Min	28.55	28.55
Max	28.56	28.56
Average	28.56	28.55
Sigma	0.00	0.00

Drift Calculation

VOP1DUTC	0 p/cm ²	2E+11 p/cm ²
OFF samples		
27	-	-5.60E-03
28	-	-5.60E-03
29	-	-5.60E-03
30	-	-4.80E-03
32	-	-4.80E-03
39	-	-5.60E-03
Average	-	-5.33E-03
Sigma	-	376.74E-06

Hirex Engineering	Protons Test Report		Ref.:	HRX/TID/0934
	LM124AJRQMLV	National Semiconductors	Issue:	01

Test conditions : Protons

Parameter : Maximum Output Voltage Swing : VOP1DUTD

+VCC=30V. -VCC=GND. Vout=30V. RL=10K

Unit : V

Spec Limit Min : 27.00

Spec limits are represented in bold lines on the graphic.

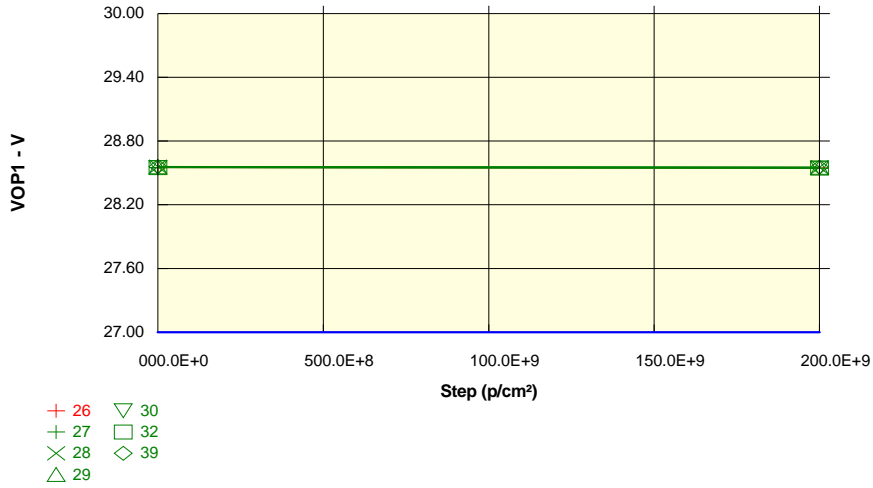

Measurements

VOP1DUTD	0 p/cm ²	2E+11 p/cm ²
26_REF	28.55	28.55
OFF samples		
27	28.55	28.54
28	28.56	28.55
29	28.56	28.55
30	28.55	28.54
32	28.55	28.54
39	28.56	28.56
Statistics		
Min	28.55	28.54
Max	28.56	28.56
Average	28.55	28.55
Sigma	0.00	0.00

Drift Calculation

VOP1DUTD	0 p/cm ²	2E+11 p/cm ²
OFF samples		
27	-	-5.60E-03
28	-	-5.60E-03
29	-	-4.80E-03
30	-	-4.80E-03
32	-	-5.60E-03
39	-	-4.80E-03
Average	-	-5.20E-03
Sigma	-	399.59E-06

Hirex Engineering	Protons Test Report		Ref.:	HRX/TID/0934
	LM124AJRQMLV	National Semiconductors	Issue:	01

Test conditions : Protons

Parameter : Maximum Output Voltage Swing : VOP2DUTA

+VCC=30V. -VCC=GND.Vout=30V. RL=2K

Unit : V

Spec Limit Min : 26.00

Spec limits are represented in bold lines on the graphic.

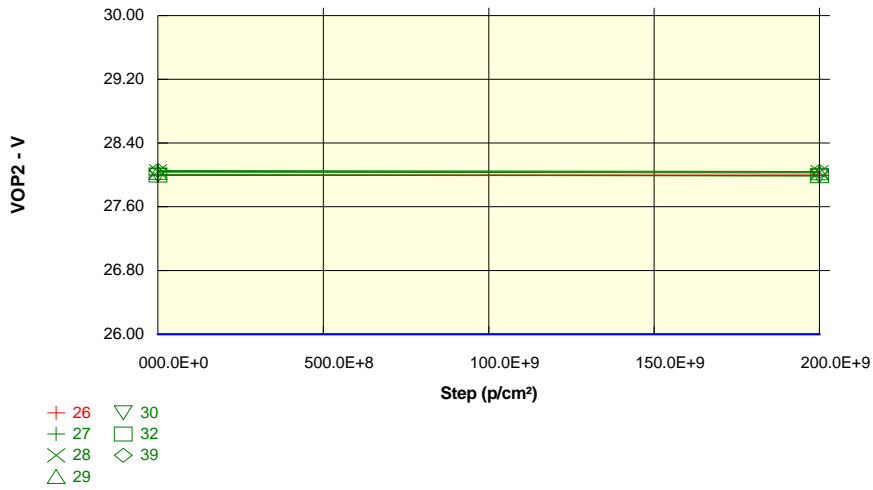

Measurements		
VOP2DUTA	0 p/cm ²	2E+11 p/cm ²
26_REF	28.00	28.00
OFF samples		
27	28.00	27.99
28	28.04	28.03
29	28.03	28.02
30	28.00	27.99
32	28.00	27.99
39	28.05	28.04
Statistics		
Min	28.00	27.99
Max	28.05	28.04
Average	28.02	28.01
Sigma	0.02	0.02

Drift Calculation		
VOP2DUTA	0 p/cm ²	2E+11 p/cm ²
OFF samples		
27	-	-7.20E-03
28	-	-9.60E-03
29	-	-8.80E-03
30	-	-8.00E-03
32	-	-8.80E-03
39	-	-9.60E-03
Average	-	-8.67E-03
Sigma	-	853.67E-06

Hirex Engineering	Protons Test Report		Ref.:	HRX/TID/0934
	LM124AJRQMLV	National Semiconductors	Issue:	01

Test conditions : Protons

Parameter : Maximum Output Voltage Swing : VOP2DUTB

+VCC=30V. -VCC=GND.Vout=30V. RL=2K

Unit : V

Spec Limit Min : 26.00

Spec limits are represented in bold lines on the graphic.

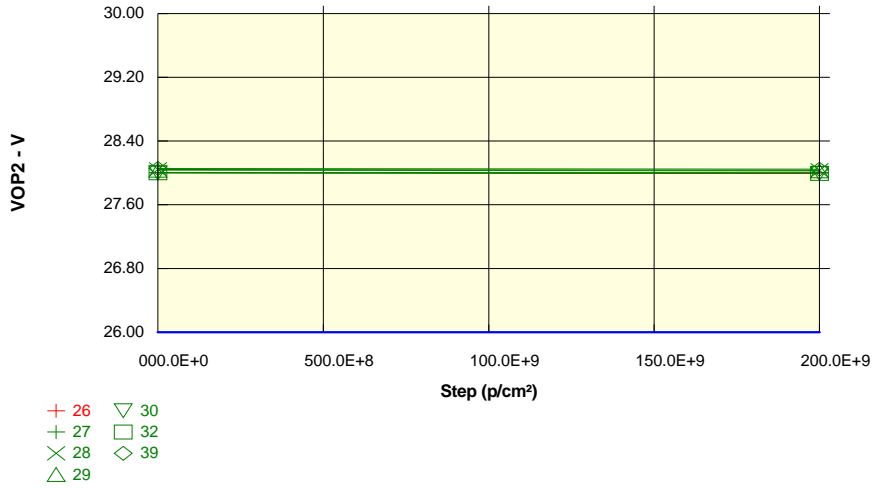

Measurements		
VOP2DUTB	0 p/cm ²	2E+11 p/cm ²
26_REF	28.00	28.00
OFF samples		
27	28.00	28.00
28	28.04	28.03
29	28.03	28.03
30	28.00	27.99
32	28.00	27.99
39	28.06	28.05
Statistics		
Min	28.00	27.99
Max	28.06	28.05
Average	28.02	28.01
Sigma	0.02	0.02

Drift Calculation		
VOP2DUTB	0 p/cm ²	2E+11 p/cm ²
OFF samples		
27	-	-7.20E-03
28	-	-10.40E-03
29	-	-8.80E-03
30	-	-8.00E-03
32	-	-8.80E-03
39	-	-9.60E-03
Average	-	-8.80E-03
Sigma	-	1.03E-03

Hirex Engineering	Protons Test Report		Ref.:	HRX/TID/0934
	LM124AJRQMLV	National Semiconductors	Issue:	01

Test conditions : Protons

Parameter : Maximum Output Voltage Swing : VOP2DUTC

+VCC=30V. -VCC=GND.Vout=30V. RL=2K

Unit : V

Spec Limit Min : 26.00

Spec limits are represented in bold lines on the graphic.

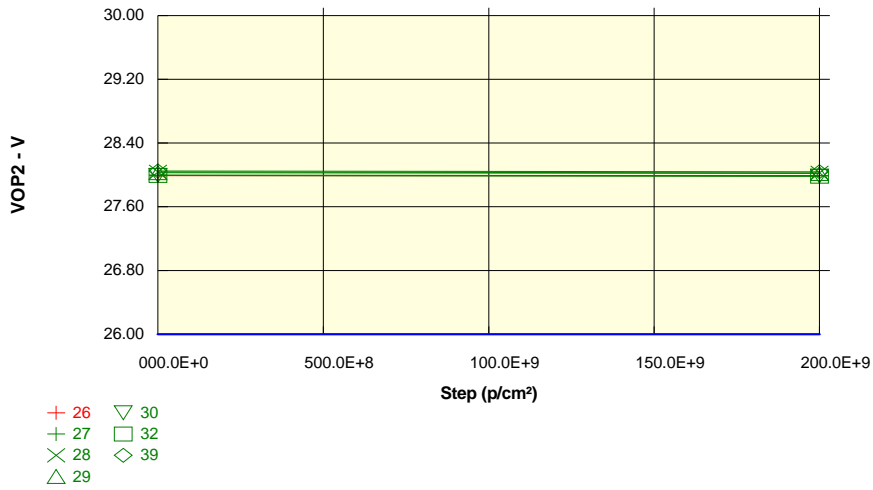

Measurements

VOP2DUTC	0 p/cm ²	2E+11 p/cm ²
26_REF	27.99	27.99
OFF samples		
27	28.00	27.99
28	28.04	28.03
29	28.03	28.02
30	27.99	27.98
32	27.99	27.98
39	28.05	28.04
Statistics		
Min	27.99	27.98
Max	28.05	28.04
Average	28.02	28.01
Sigma	0.02	0.02

Drift Calculation

VOP2DUTC	0 p/cm ²	2E+11 p/cm ²
OFF samples		
27	-	-8.00E-03
28	-	-9.60E-03
29	-	-9.60E-03
30	-	-8.00E-03
32	-	-8.00E-03
39	-	-9.60E-03
Average	-	-8.80E-03
Sigma	-	800.13E-06

Hirex Engineering	Protons Test Report		Ref.:	HRX/TID/0934
	LM124AJRQMLV	National Semiconductors	Issue:	01

Test conditions : Protons

Parameter : Maximum Output Voltage Swing : VOP2DUTD

+VCC=30V. -VCC=GND.Vout=30V. RL=2K

Unit : V

Spec Limit Min : 26.00

Spec limits are represented in bold lines on the graphic.

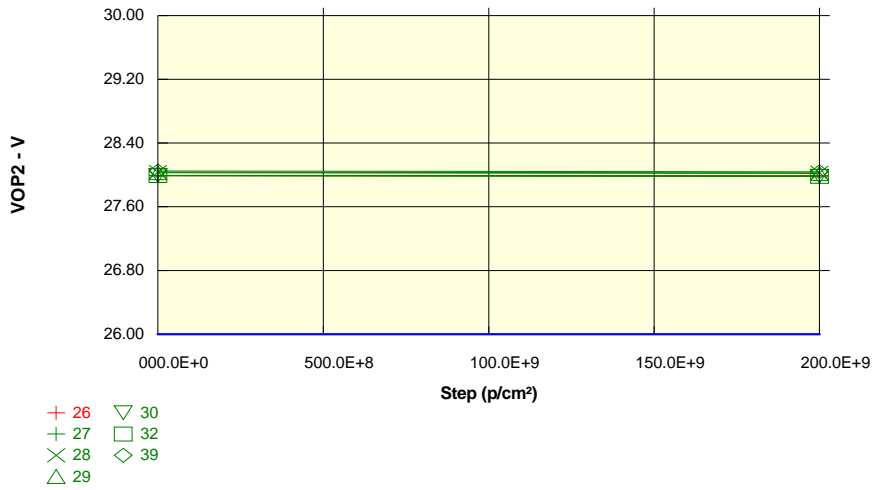

Measurements

VOP2DUTD	0 p/cm ²	2E+11 p/cm ²
26_REF	27.99	27.99
OFF samples		
27	27.99	27.98
28	28.04	28.02
29	28.03	28.02
30	27.99	27.98
32	27.99	27.98
39	28.05	28.04
Statistics		
Min	27.99	27.98
Max	28.05	28.04
Average	28.01	28.01
Sigma	0.02	0.02

Drift Calculation

VOP2DUTD	0 p/cm ²	2E+11 p/cm ²
OFF samples		
27	-	-8.00E-03
28	-	-10.40E-03
29	-	-9.60E-03
30	-	-8.00E-03
32	-	-8.80E-03
39	-	-9.60E-03
Average	-	-9.07E-03
Sigma	-	884.96E-06