

TOTAL IONIZING DOSE TEST REPORT

40MHz-CFPT9006 SMD Temperature Compensated Crystal Oscillator (PLUTO) *From* Rakon

Ref: TRAD/TE/40MHz-CFPT9006/XXXI/ESA/BR/1207		Labège, December 10 th , 2012			
 		TRAD, Bat. Gallium 907, Voie l'Occitane 31670 LABEGE Cedex ☎ : (33)5 61 00 95 60 Fax: (33)5 61 00 95 61 E-mail: trad@trad.fr http://www.trad.fr			
Written by		Verified by / Quality control		Approved by	
Name: B. RENAUD Date: 10/12/2012 		Name: P. GARCIA Date: 10/12/2012 		Name: Y. PADIÉ Date: 10/12/2012 	
Rev.	Change description	Comment			
0	First issue	November 21 st , 2012			
1	Appendix D : Graph modification	December 10 th , 2012			
TO: EUROPEAN SPACE AGENCY Mr. Christian POIVEY		Ref: 4000105666/12/NL/SFe , Radiation Characterization of Commercial EEE Components for Space Applications, Project/program: COO1: Radiation Characterization of TE115/125 XO oscillator from RAKON/TEMEX			

CONTENTS

1.	INTRODUCTION.....	3
2.	DOCUMENTS.....	3
2.1.	Applicable documents.....	3
2.2.	Reference documents.....	3
3.	PART INFORMATIONS.....	3
4.	DOSIMETRY AND IRRADIATION FACILITY.....	4
5.	TEST EQUIPMENT IDENTIFICATION.....	4
6.	TEST PARAMETERS.....	5
7.	BIAS CONDITIONS.....	6
8.	PICTURE SAMPLE.....	7
9.	TEST STORY.....	8
10.	RESULTS.....	8
10.1.	Presentation of the results.....	8
10.2.	Comments.....	8
10.3.	Electrical parameters of parts biased ON – MODE1.....	10
10.4.	Electrical parameters of parts biased ON – MODE2.....	11
10.5.	Electrical parameters of parts biased OFF.....	12
11.	CONCLUSION.....	13

FIGURES

Figure 1 :	Mode 1 Bias Conditions.....	6
Figure 2 :	Mode 2 Bias Conditions.....	6
Figure 3 :	Picture sample.....	7

1. Introduction

This report includes test results of **40MHz-CFPT9006**, a **SMD Temperature Compensated Crystal Oscillator (PLUTO)** from **Rakon** after submission to total ionizing dose testing.

2. Documents

2.1. Applicable documents

Technical Proposal : TRAD/PF/ESA/COO1/CC/071111 rev.0.
Irradiation test plan : ITP-TE-40MHz-CFPT9006-RAK-ESA-1227 Issue 3 of 24-08-2012.

2.2. Reference documents

RAKON Specification : E2900LF-RAD Issue A of 20-06-2012.

3. Part Informations

PART IDENTIFICATION	
Type :	40MHz-CFPT9006
Manufacturer :	RAKON
Function :	SMD Temperature Compensated Crystal Oscillator (PLUTO)

PARTS PROCUREMENT INFORMATIONS	
Packaging :	SMD
Sample size :	15 irradiated samples + 1 reference sample

4. Dosimetry and irradiation facility

IRRADIATION FACILITY	
Irradiation source :	⁶⁰ Co
Source location :	U.C.L (Louvain-la-Neuve)
Irradiation equipment :	GIF
Dosimetry equipment :	PTW Ionization chamber

IRRADIATION TIME LOG								
Total dose limit (krad(Si)):	100							
Level for measurement (krad(Si)) :	0	9	21	30	50	58	80	100
Dose rate (krad(Si)/h) :	0.31							

ANNEALING TIME LOG	
Annealing 25°C :	24 hours
Annealing 100°C :	168 hours

5. Test equipment identification

COMPUTER	PC-UCL2
REF. TEST BOARD	TRAD/CT1/E/CFPT9006/SMD10/BR/1207
EQUIPMENT	ME-58 ; ME-59 ;MI-08 ; GR-28 ; SM-15
TEST PROGRAM	CFPT9006_TE_XXX1_B2_V10.11b CFPT9006_TE_XXX1_B2_V20.11b CFPT9006_TE_XXX1_B2_V30.11b

6. Test parameters

PARAMETERS	SYMBOLS	TEST CONDITIONS
Ta = 25°C , +Vs = 3.3V , unless otherwise specified		
Frequency calibration	F	
Supply voltage stability	Fstab	+2.97V < +Vs < +3.63V
Supply current	Is	
Output voltage level low	VOL	
Output voltage level high	VOH	
Rise time	Tr	10% to 90% level
Fall time	Tf	90% to 10% level
Duty cycle	Dc	at 50% level
Tristate input high voltage	VIH	
Tristate input low voltage	VIL	

7. Bias conditions

All components are biased under following conditions.

Parameters specified in the applicable ITP are measured on one component that is kept as REFERENCE and therefore is not irradiated.

PARTS IDENTIFICATION

Serial Number	Control	Sample Devices				
Mark	1	2	3	4	5	6
Irr. Marking	1	2	3	4	5	6
Biasing Mode	REF	Mode1	Mode1	Mode1	Mode1	Mode1
Mark	1	7	8	9	10	11
Irr. Marking	1	7	8	9	10	11
Biasing Mode	REF	Mode2	Mode2	Mode2	Mode2	Mode2
Mark	1	12	13	14	15	16
Irr. Marking	1	12	13	14	15	16
Biasing Mode	REF	OFF	OFF	OFF	OFF	OFF

BIASING CONDITIONS

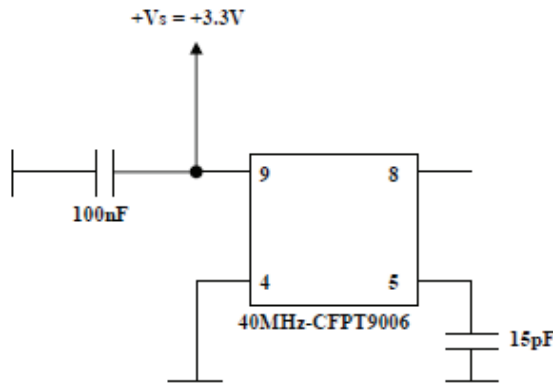

Figure 1 : Mode 1 Bias Conditions

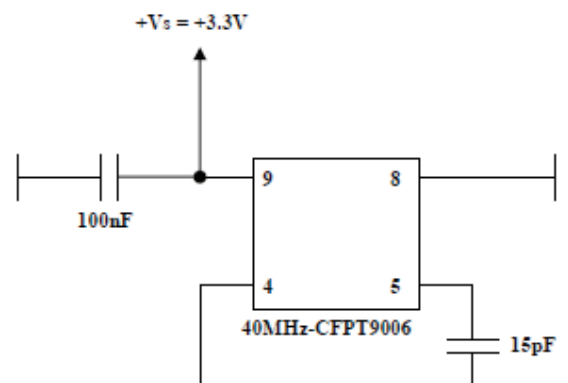

Figure 2 : Mode 2 Bias Conditions

COMMENTS

Parts biased in static ON Mode1	5
Parts biased in static ON Mode2	5
Parts biased in static OFF Mode	5
Bias Board Ref	TRAD/CP1/E/CFPT9006/SMD10/BR/1208 TRAD/CP1/P/5-OFF/DIL16/MV/1108
Bias Equipment	ME-68

8. Picture Sample

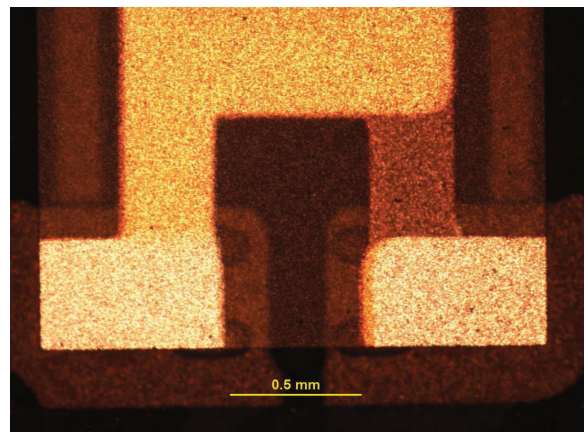
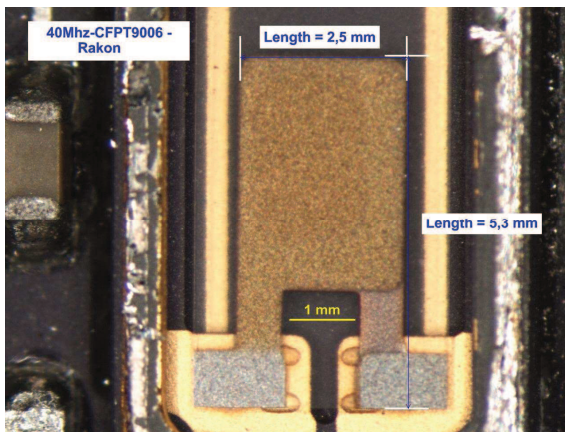
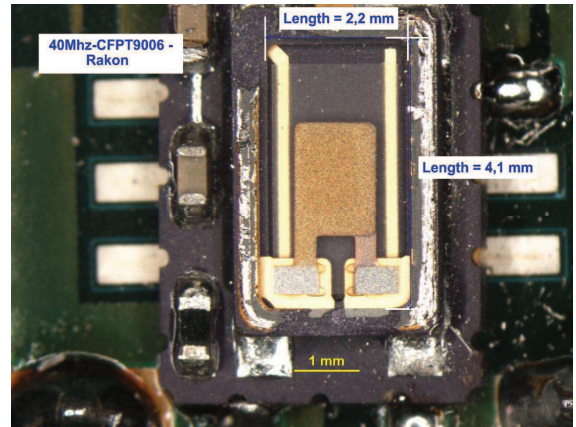
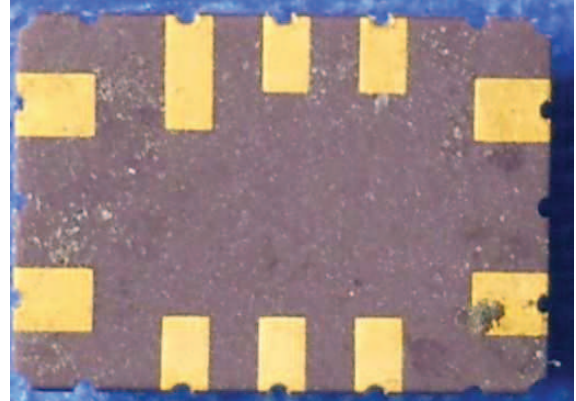

Figure 3 : Picture sample

9. Test Story

For the parts biased with mode1 and mode2 the output of all parts didn't switch at 50krad. These parts were put in annealing 24h/25°C followed by an annealing 168h/100°C.

10. Results

10.1. Presentation of the results

For each parameter :

- The measurements performed at each irradiation step are registered in a table.
- Drifts between each measurement step and the "0" krad(Si) step are computed.

NB : * For the CTR and the Hfe parameters, the formula used is :

$$\text{Drift} = [\text{measurement}(X \text{ krad(Si)})]^{-1} - [\text{measurement}(0 \text{ krad(Si)})]^{-1}$$

* For the other measurements, the formula used is :

$$\text{Drift} = \text{measurement}(X \text{ krad(Si)}) - \text{measurement}(0 \text{ krad(Si)})$$

Where X stands for each measurement step.

10.2. Comments

=> Electrical parameters parts biased **ON - MODE1**:

- The parameter **F** is out of specification at **9.2 krad(Si)** by interpolation.
- The parameter **Fstab** is out of specification at **10.4 krad(Si)** by interpolation.
- The parameter **Is** is out of specification at **12.8 krad(Si)** by interpolation.
- The parameter **Dc** is out of specification at **20.5 krad(Si)** by interpolation.
- The parameter **VOL** is not measurable at step **50.0 krad(Si)**.
- The parameter **VOH** is not measurable at step **50.0 krad(Si)**.
- The parameter **Tr** is not measurable at step **50.0 krad(Si)**.
- The parameter **Tf** is not measurable at step **50.0 krad(Si)**.
- The parameter **VIH** is not measurable at step **50.0 krad(Si)**.
- The parameter **VIL** is not measurable at step **50.0 krad(Si)**.

=> Electrical parameters parts biased **ON - MODE2**:

	<p style="text-align: center;">TOTAL IONIZING DOSE TEST REPORT</p> <p style="text-align: center;">40MHz-CFPT9006</p>	<p>Ref: TRAD/TE/40MHz-CFPT9006/XXX1/ESA/BR/1207 Date: December 10th, 2012</p> <p>Rev: 1</p>
---	--	--

- The parameter **F** is out of specification at **9.2 krad(Si)** by interpolation.
- The parameter **Fstab** is out of specification at **11.1 krad(Si)** by interpolation.
- The parameter **Is** is out of specification at **12.9 krad(Si)** by interpolation.
- The parameter **Dc** is out of specification at **21.1 krad(Si)** by interpolation.
- The parameter **VOL** is not measurable at step **50.0 krad(Si)**.
- The parameter **VOH** is not measurable at step **50.0 krad(Si)**.
- The parameter **Tr** is not measurable at step **50.0 krad(Si)**.
- The parameter **Tf** is not measurable at step **50.0 krad(Si)**.
- The parameter **VIH** is not measurable at step **50.0 krad(Si)**.
- The parameter **VIL** is not measurable at step **50.0 krad(Si)**.

=> Electrical parameters parts biased **OFF**:

- All parameters are within specifications at total dose level.

The evolution of each parameter versus accumulated total dose is registered in the following pages.

10.3. Electrical parameters of parts biased ON – MODE1

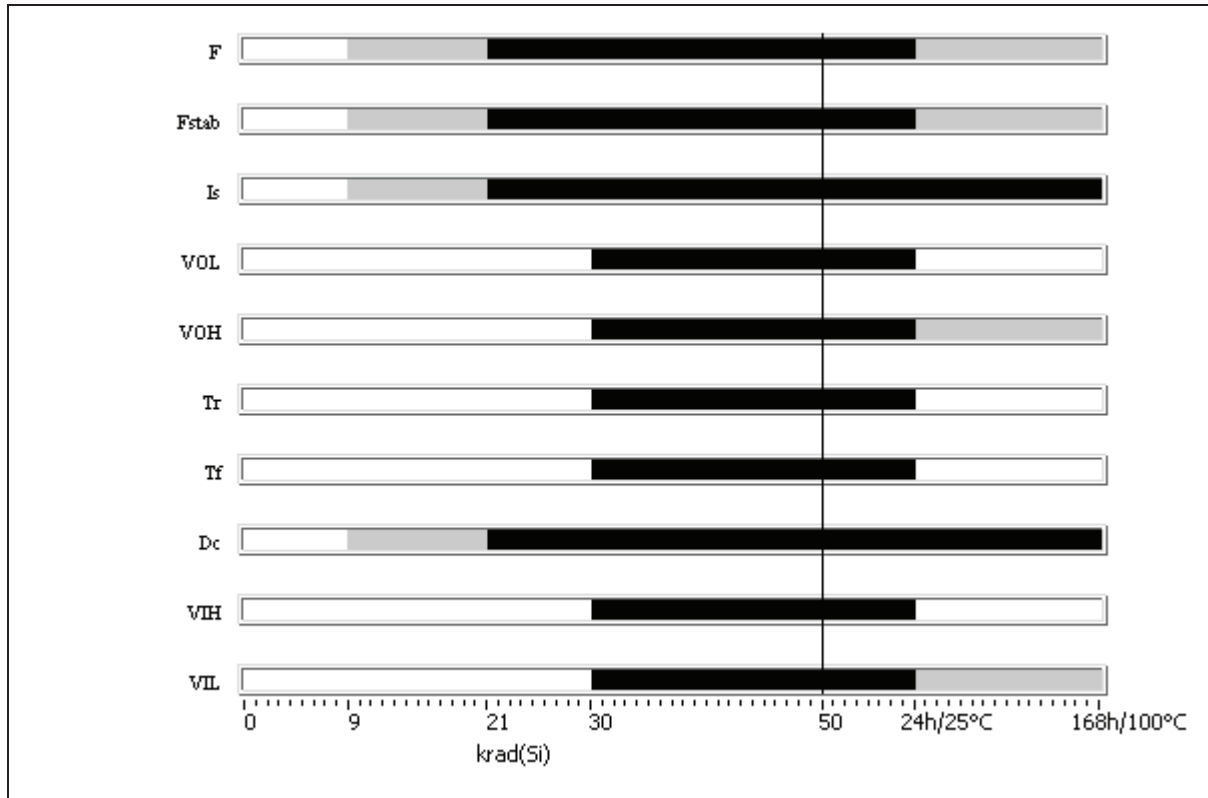

- Within specification
- Transition
- Out of specification or parameter not measurable

10.4. Electrical parameters of parts biased ON – MODE2

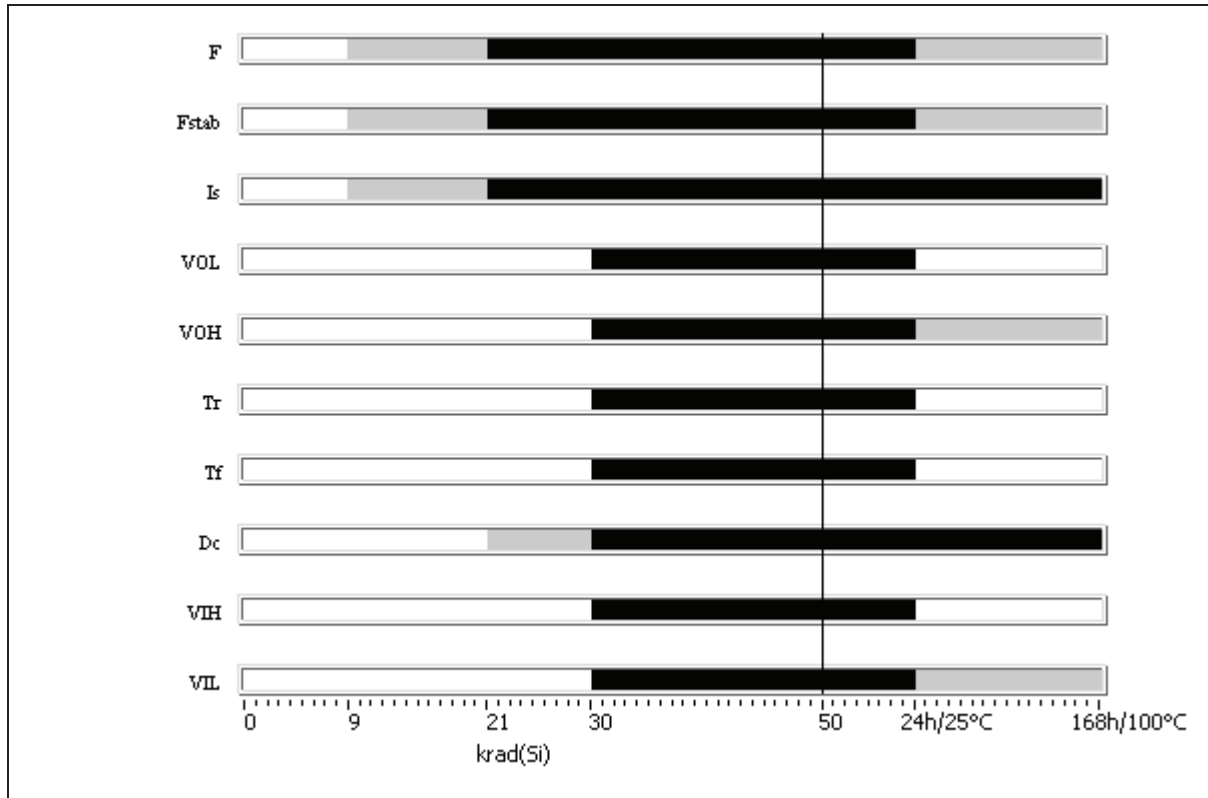

- Within specification
- Transition
- Out of specification or parameter not measurable

10.5. Electrical parameters of parts biased OFF

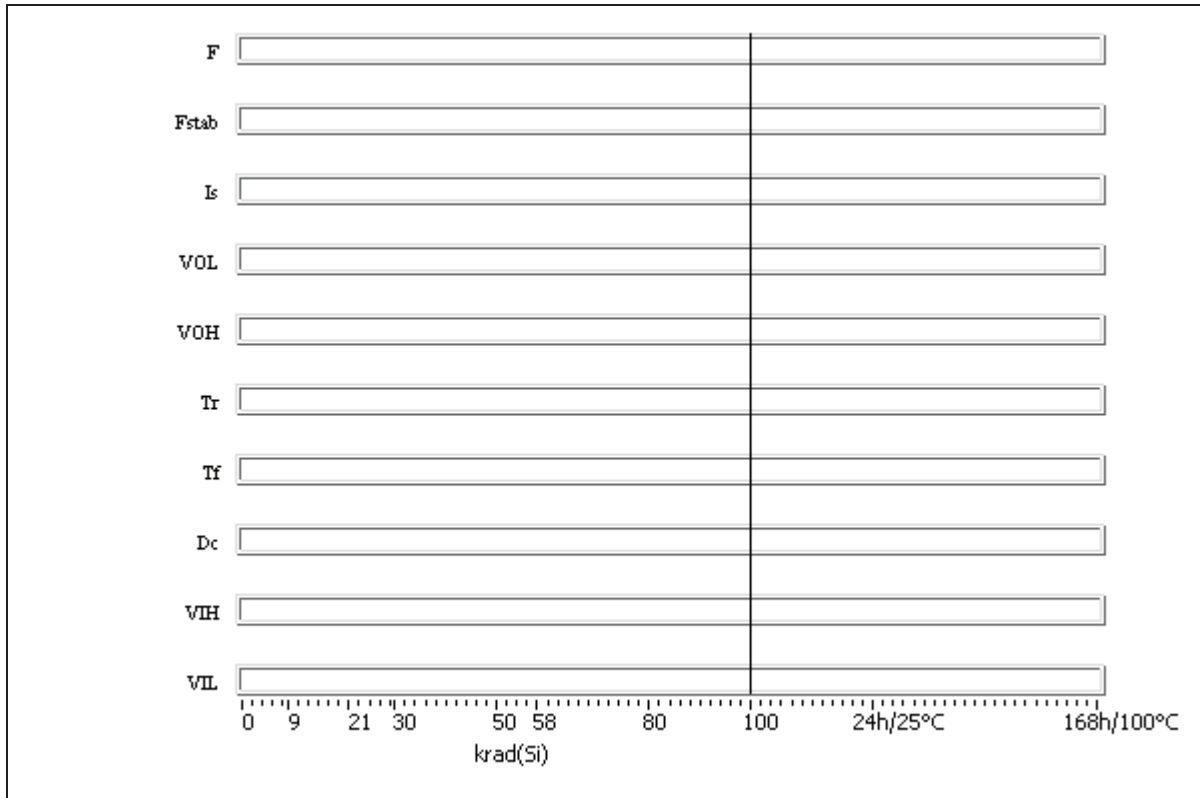

- Within specification
- Transition
- Out of specification or parameter not measurable

	TOTAL IONIZING DOSE TEST REPORT 40MHz-CFPT9006	Ref: TRAD/TE/40MHz-CFPT9006/XXX1/ESA/BR/1207 Date: December 10 th , 2012 Rev: 1
---	---	--

11. Conclusion

Total dose steady-state irradiation test using gamma rays from Cobalt 60 source has been carried out on 15 **40MHz-CFPT9006**, a **SMD Temperature Compensated Crystal Oscillator (PLUTO)** from **Rakon** up to 100 krad(Si) for parts unbiased and 50 krad(Si) for parts biased, at low dose rate (0.31 krad(Si)/h).

Final test results are :

Biased parts are measurable up to 30krad(Si) but not at 50krad(Si).

After annealing 168h at 100°C, all parts can be measured again.

Unbiased parts are measurable up to the total dose level.



**TOTAL IONIZING DOSE
TEST REPORT**

40MHz-CFPT9006

Ref: TRAD/TE/40MHz-CFPT9006/XXX1/ESA/BR/1207
Date: December 10th, 2012

Rev: 1

12. APPENDIX A : PARTS MODE1 TESTS RESULTS

Contents :

1 F	A-2
2 Fstab	A-3
3 Is	A-4
4 VOL	A-5
5 VOH	A-6
6 Tr	A-7
7 Tf	A-8
8 Dc	A-9
9 VIH	A-10
10 VIL	A-11

1. F

Ta = 25°C ; +Vs = +3.3V

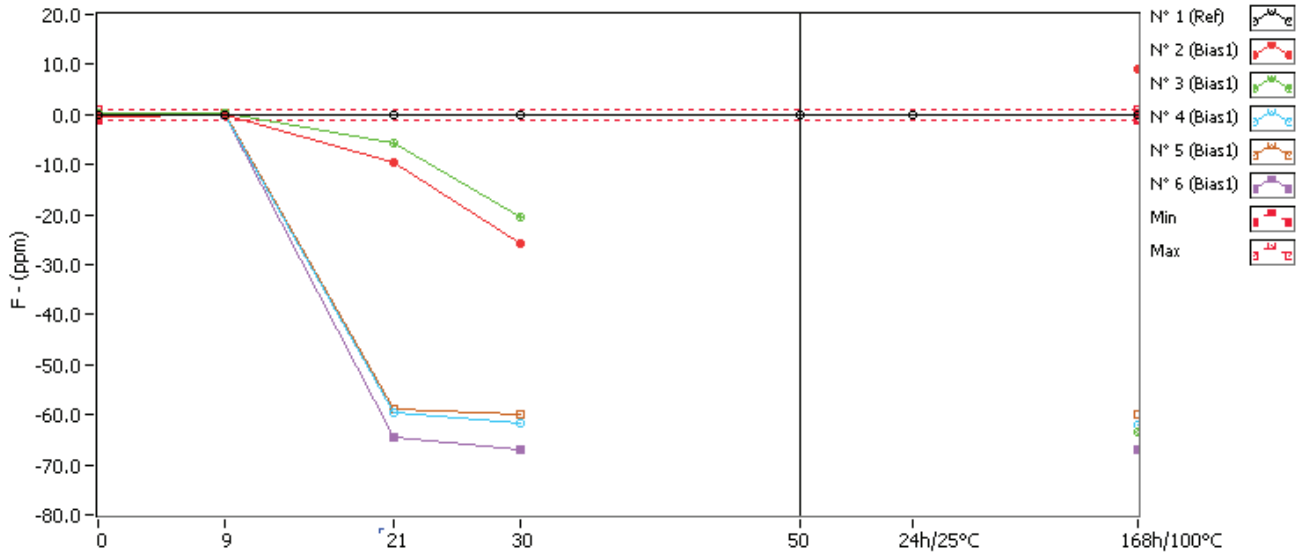

F . (ppm) Min = -1.0 Max = 1.0

	0krad(Si)	9krad(Si)	21krad(Si)	30krad(Si)	50krad(Si)	24h/25°C	168h/100°C
N° 1 (Ref)	0.025	0.025	0.050	0.025	0.025	0.000	0.050
N° 2 (Bias1)	-0.275	-0.175	-9.675	-25.750	Not Measurable*	Not Measurable*	9.125
N° 3 (Bias1)	0.200	0.275	-5.600	-20.525	Not Measurable*	Not Measurable*	-63.500
N° 4 (Bias1)	-0.225	-0.175	-59.750	-61.750	Not Measurable*	Not Measurable*	-62.000
N° 5 (Bias1)	0.050	0.150	-58.750	-59.800	Not Measurable*	Not Measurable*	-60.025
N° 6 (Bias1)	0.075	0.025	-64.425	-67.100	Not Measurable*	Not Measurable*	-67.000

* The output don't switch ON.

Delta [F]

	0krad(Si)	9krad(Si)	21krad(Si)	30krad(Si)	50krad(Si)	24h/25°C	168h/100°C
N° 1 (Ref)	---	0.000E+0	2.500E-2	0.000E+0	0.000E+0	-2.500E-2	2.500E-2
N° 2 (Bias1)	---	1.000E-1	-9.400E+0	-2.548E+1	NaN	NaN	9.400E+0
N° 3 (Bias1)	---	7.500E-2	-5.800E+0	-2.072E+1	NaN	NaN	-6.370E+1
N° 4 (Bias1)	---	5.000E-2	-5.952E+1	-6.152E+1	NaN	NaN	-6.177E+1
N° 5 (Bias1)	---	1.000E-1	-5.880E+1	-5.985E+1	NaN	NaN	-6.007E+1
N° 6 (Bias1)	---	-5.000E-2	-6.450E+1	-6.717E+1	NaN	NaN	-6.708E+1
Average (Bias1)	---	5.500E-2	-3.961E+1	-4.695E+1	NaN	NaN	-4.864E+1
s (Bias1)	---	6.225E-2	2.933E+1	2.200E+1	0.000E+0	0.000E+0	3.255E+1
Average+3s (Bias1)	---	2.417E-1	4.837E+1	1.906E+1	NaN	NaN	4.901E+1
Average-3s (Bias1)	---	-1.317E-1	-1.276E+2	-1.130E+2	NaN	NaN	-1.463E+2

2. Fstab

Ta = 25°C ; +2.97V < +Vs < +3.63V

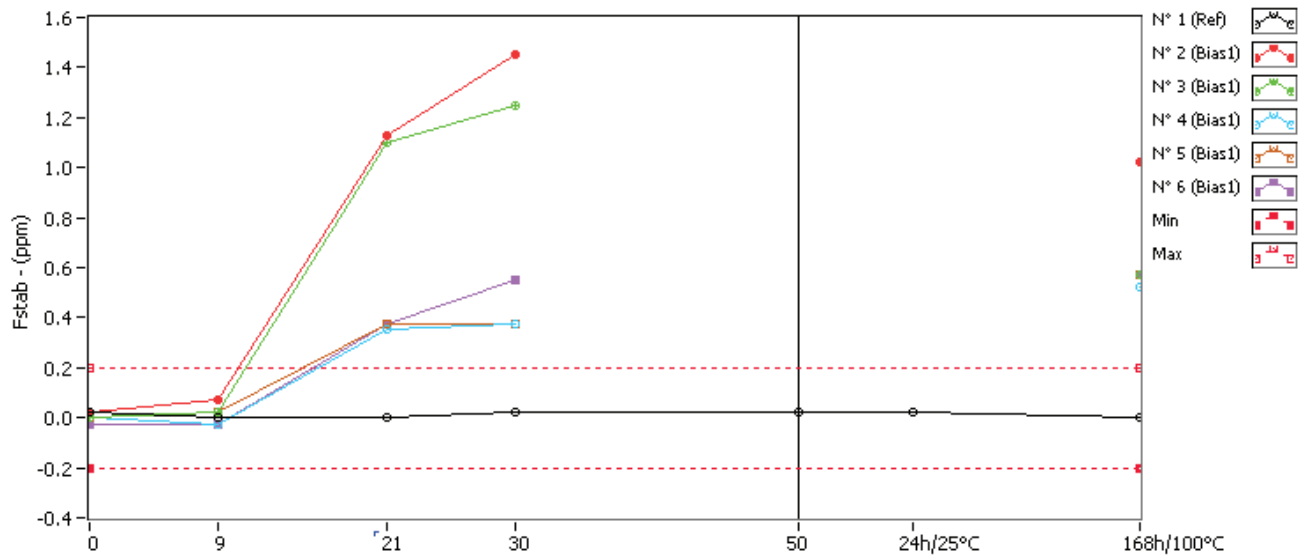

Fstab . (ppm) Min = -0.2 Max = 0.2

	0krad(Si)	9krad(Si)	21krad(Si)	30krad(Si)	50krad(Si)	24h/25°C	168h/100°C
N° 1 (Ref)	0.025	0.000	0.000	0.025	0.025	0.025	0.000
N° 2 (Bias1)	0.025	0.075	1.125	1.450	Not Measurable*	Not Measurable*	1.025
N° 3 (Bias1)	0.000	0.025	1.100	1.250	Not Measurable*	Not Measurable*	0.575
N° 4 (Bias1)	0.000	-0.025	0.350	0.375	Not Measurable*	Not Measurable*	0.525
N° 5 (Bias1)	0.000	0.025	0.375	0.375	Not Measurable*	Not Measurable*	0.575
N° 6 (Bias1)	-0.025	-0.025	0.375	0.550	Not Measurable*	Not Measurable*	0.575

* The output don't switch ON.

Delta [Fstab]

	0krad(Si)	9krad(Si)	21krad(Si)	30krad(Si)	50krad(Si)	24h/25°C	168h/100°C
N° 1 (Ref)	---	-2.500E-2	-2.500E-2	0.000E+0	0.000E+0	0.000E+0	-2.500E-2
N° 2 (Bias1)	---	5.000E-2	1.100E+0	1.425E+0	NaN	NaN	1.000E+0
N° 3 (Bias1)	---	2.500E-2	1.100E+0	1.250E+0	NaN	NaN	5.750E-1
N° 4 (Bias1)	---	-2.500E-2	3.500E-1	3.750E-1	NaN	NaN	5.250E-1
N° 5 (Bias1)	---	2.500E-2	3.750E-1	3.750E-1	NaN	NaN	5.750E-1
N° 6 (Bias1)	---	0.000E+0	4.000E-1	5.750E-1	NaN	NaN	6.000E-1
Average (Bias1)	---	1.500E-2	6.650E-1	8.000E-1	NaN	NaN	6.550E-1
s (Bias1)	---	2.850E-2	3.975E-1	5.013E-1	0.000E+0	0.000E+0	1.948E-1
Average+3s (Bias1)	---	1.005E-1	1.857E+0	2.304E+0	NaN	NaN	1.239E+0
Average-3s (Bias1)	---	-7.051E-2	-5.274E-1	-7.037E-1	NaN	NaN	7.076E-2

3. Is

Ta = 25°C ; +Vs = +3.3V

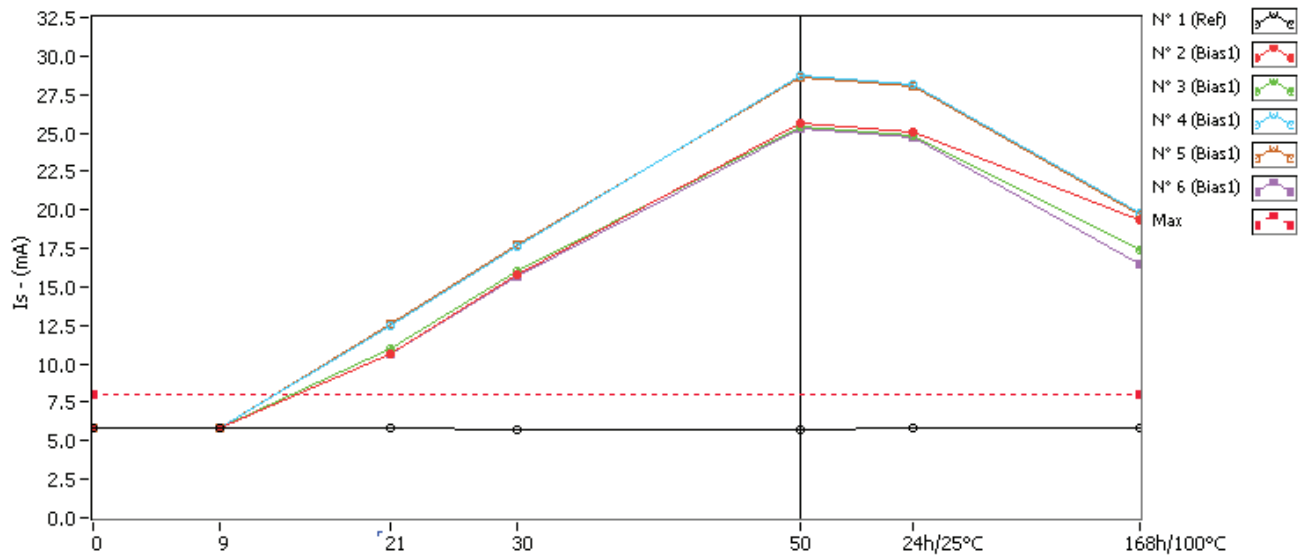

Is . (mA) Max = 8.0

	0krad(Si)	9krad(Si)	21krad(Si)	30krad(Si)	50krad(Si)	24h/25°C	168h/100°C
N° 1 (Ref)	5.830	5.835	5.815	5.753	5.754	5.784	5.822
N° 2 (Bias1)	5.798	5.809	10.647	15.798	25.634	25.108	19.291
N° 3 (Bias1)	5.831	5.846	10.955	16.040	25.419	24.844	17.369
N° 4 (Bias1)	5.838	5.881	12.487	17.585	28.730	28.125	19.806
N° 5 (Bias1)	5.839	5.886	12.537	17.715	28.660	28.048	19.657
N° 6 (Bias1)	5.831	5.844	10.686	15.709	25.321	24.734	16.483

Delta [Is]

	0krad(Si)	9krad(Si)	21krad(Si)	30krad(Si)	50krad(Si)	24h/25°C	168h/100°C
N° 1 (Ref)	---	5.635E-3	-1.467E-2	-7.642E-2	-7.605E-2	-4.538E-2	-8.055E-3
N° 2 (Bias1)	---	1.093E-2	4.849E+0	9.999E+0	1.984E+1	1.931E+1	1.349E+1
N° 3 (Bias1)	---	1.519E-2	5.124E+0	1.021E+1	1.959E+1	1.901E+1	1.154E+1
N° 4 (Bias1)	---	4.352E-2	6.649E+0	1.175E+1	2.289E+1	2.229E+1	1.397E+1
N° 5 (Bias1)	---	4.758E-2	6.698E+0	1.188E+1	2.282E+1	2.221E+1	1.382E+1
N° 6 (Bias1)	---	1.273E-2	4.854E+0	9.878E+0	1.949E+1	1.890E+1	1.065E+1
Average (Bias1)	---	2.599E-2	5.635E+0	1.074E+1	2.093E+1	2.034E+1	1.269E+1
s (Bias1)	---	1.798E-2	9.549E-1	9.849E-1	1.768E+0	1.745E+0	1.503E+0
Average+3s (Bias1)	---	7.992E-2	8.499E+0	1.370E+1	2.623E+1	2.558E+1	1.720E+1
Average-3s (Bias1)	---	-2.795E-2	2.770E+0	7.787E+0	1.562E+1	1.511E+1	8.185E+0

4. VOL

Ta = 25°C ; +Vs = +3.3V

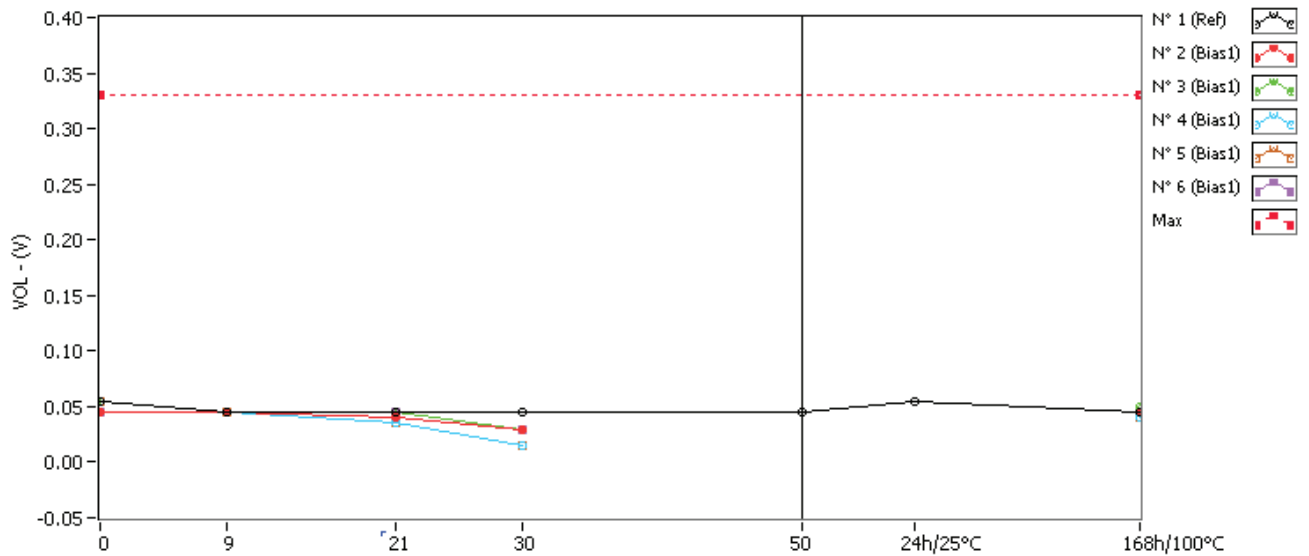

VOL . (V) Max = 0.33

	0krad(Si)	9krad(Si)	21krad(Si)	30krad(Si)	50krad(Si)	24h/25°C	168h/100°C
N° 1 (Ref)	0.055	0.045	0.045	0.045	0.045	0.055	0.045
N° 2 (Bias1)	0.045	0.045	0.040	0.030	Not Measurable*	Not Measurable*	0.045
N° 3 (Bias1)	0.055	0.045	0.045	0.030	Not Measurable*	Not Measurable*	0.050
N° 4 (Bias1)	0.055	0.045	0.035	0.015	Not Measurable*	Not Measurable*	0.040
N° 5 (Bias1)	0.055	0.045	0.035	0.015	Not Measurable*	Not Measurable*	0.040
N° 6 (Bias1)	0.045	0.045	0.045	0.030	Not Measurable*	Not Measurable*	0.045

* The output don't switch ON.

Delta [VOL]

	0krad(Si)	9krad(Si)	21krad(Si)	30krad(Si)	50krad(Si)	24h/25°C	168h/100°C
N° 1 (Ref)	---	-1.000E-2	-1.000E-2	-1.000E-2	-1.000E-2	0.000E+0	-1.000E-2
N° 2 (Bias1)	---	0.000E+0	-5.000E-3	-1.500E-2	NaN	NaN	0.000E+0
N° 3 (Bias1)	---	-1.000E-2	-1.000E-2	-2.500E-2	NaN	NaN	-5.000E-3
N° 4 (Bias1)	---	-1.000E-2	-2.000E-2	-4.000E-2	NaN	NaN	-1.500E-2
N° 5 (Bias1)	---	-1.000E-2	-2.000E-2	-4.000E-2	NaN	NaN	-1.500E-2
N° 6 (Bias1)	---	0.000E+0	0.000E+0	-1.500E-2	NaN	NaN	0.000E+0
Average (Bias1)	---	-6.000E-3	-1.100E-2	-2.700E-2	NaN	NaN	-7.000E-3
s (Bias1)	---	5.477E-3	8.944E-3	1.255E-2	0.000E+0	0.000E+0	7.583E-3
Average+3s (Bias1)	---	1.043E-2	1.583E-2	1.065E-2	NaN	NaN	1.575E-2
Average-3s (Bias1)	---	-2.243E-2	-3.783E-2	-6.465E-2	NaN	NaN	-2.975E-2

5. VOH

Ta = 25°C ; +Vs = +3.3V

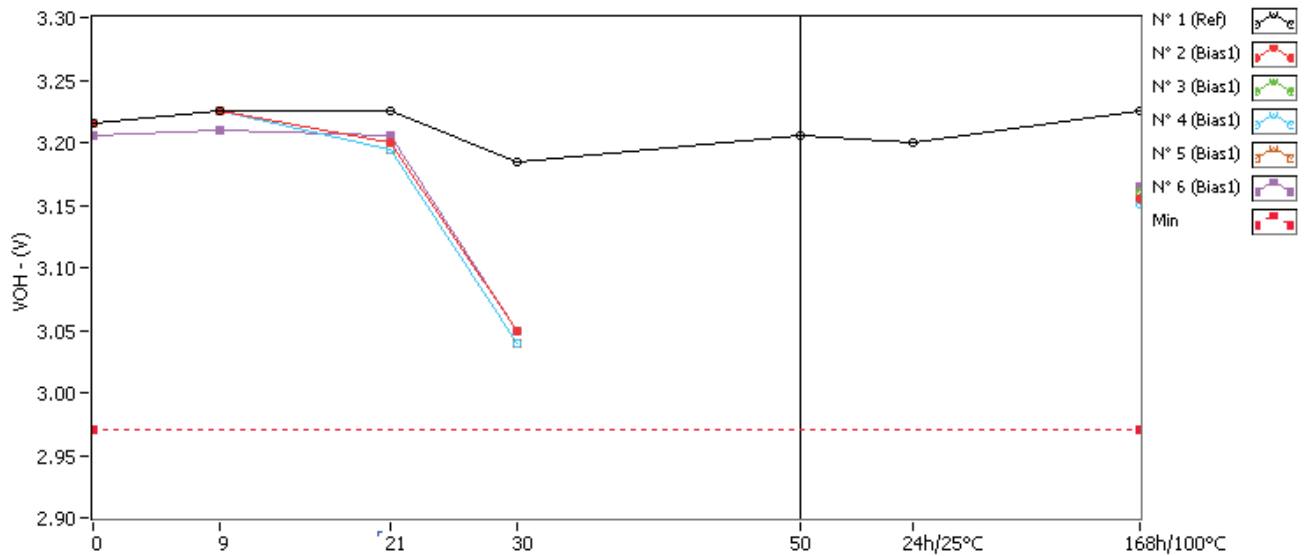

VOH . (V) Min = 2.97

	0krad(Si)	9krad(Si)	21krad(Si)	30krad(Si)	50krad(Si)	24h/25°C	168h/100°C
N° 1 (Ref)	3.215	3.225	3.225	3.185	3.205	3.200	3.225
N° 2 (Bias1)	3.215	3.225	3.200	3.050	Not Measurable*	Not Measurable*	3.155
N° 3 (Bias1)	3.215	3.225	3.200	3.050	Not Measurable*	Not Measurable*	3.160
N° 4 (Bias1)	3.215	3.225	3.195	3.040	Not Measurable*	Not Measurable*	3.150
N° 5 (Bias1)	3.215	3.225	3.195	3.040	Not Measurable*	Not Measurable*	3.160
N° 6 (Bias1)	3.205	3.210	3.205	3.050	Not Measurable*	Not Measurable*	3.165

* The output don't switch ON.

Delta [VOH]

	0krad(Si)	9krad(Si)	21krad(Si)	30krad(Si)	50krad(Si)	24h/25°C	168h/100°C
N° 1 (Ref)	---	1.000E-2	1.000E-2	-3.000E-2	-1.000E-2	-1.500E-2	1.000E-2
N° 2 (Bias1)	---	1.000E-2	-1.500E-2	-1.650E-1	NaN	NaN	-6.000E-2
N° 3 (Bias1)	---	1.000E-2	-1.500E-2	-1.650E-1	NaN	NaN	-5.500E-2
N° 4 (Bias1)	---	1.000E-2	-2.000E-2	-1.750E-1	NaN	NaN	-6.500E-2
N° 5 (Bias1)	---	1.000E-2	-2.000E-2	-1.750E-1	NaN	NaN	-5.500E-2
N° 6 (Bias1)	---	5.000E-3	0.000E+0	-1.550E-1	NaN	NaN	-4.000E-2
Average (Bias1)	---	9.000E-3	-1.400E-2	-1.670E-1	NaN	NaN	-5.500E-2
s (Bias1)	---	2.236E-3	8.216E-3	8.367E-3	0.000E+0	0.000E+0	9.354E-3
Average+3s (Bias1)	---	1.571E-2	1.065E-2	-1.419E-1	NaN	NaN	-2.694E-2
Average-3s (Bias1)	---	2.292E-3	-3.865E-2	-1.921E-1	NaN	NaN	-8.306E-2

6. Tr

Ta = 25°C ; +Vs = +3.3V ; 10% to 90% level

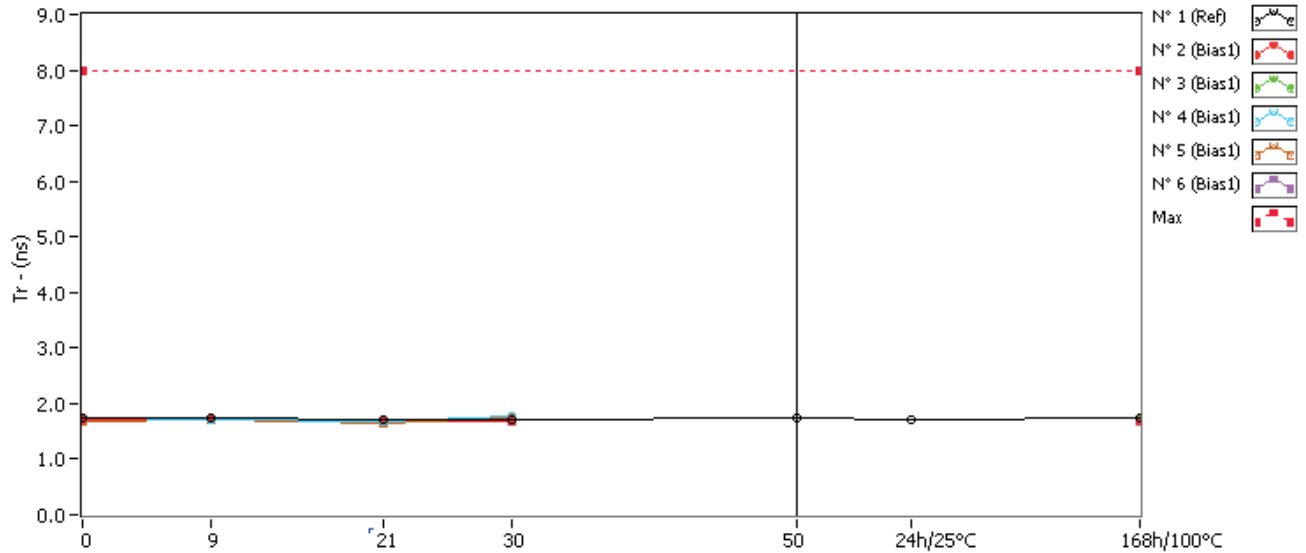

Tr . (ns) Max = 8.0

	0krad(Si)	9krad(Si)	21krad(Si)	30krad(Si)	50krad(Si)	24h/25°C	168h/100°C
N° 1 (Ref)	1.731	1.756	1.727	1.725	1.738	1.722	1.734
N° 2 (Bias1)	1.706	1.739	1.703	1.694	Not Measurable*	Not Measurable*	1.680
N° 3 (Bias1)	1.728	1.750	1.717	1.702	Not Measurable*	Not Measurable*	1.726
N° 4 (Bias1)	1.700	1.721	1.670	1.770	Not Measurable*	Not Measurable*	1.676
N° 5 (Bias1)	1.687	1.712	1.657	1.757	Not Measurable*	Not Measurable*	1.702
N° 6 (Bias1)	1.686	1.709	1.682	1.671	Not Measurable*	Not Measurable*	1.670

* The output don't switch ON.

Delta [Tr]

	0krad(Si)	9krad(Si)	21krad(Si)	30krad(Si)	50krad(Si)	24h/25°C	168h/100°C
N° 1 (Ref)	---	2.520E-2	-4.000E-3	-6.200E-3	7.600E-3	-9.100E-3	3.400E-3
N° 2 (Bias1)	---	3.300E-2	-3.600E-3	-1.210E-2	NaN	NaN	-2.610E-2
N° 3 (Bias1)	---	2.120E-2	-1.130E-2	-2.620E-2	NaN	NaN	-2.700E-3
N° 4 (Bias1)	---	2.080E-2	-3.040E-2	7.020E-2	NaN	NaN	-2.470E-2
N° 5 (Bias1)	---	2.500E-2	-2.940E-2	7.030E-2	NaN	NaN	1.550E-2
N° 6 (Bias1)	---	2.320E-2	-4.000E-3	-1.540E-2	NaN	NaN	-1.580E-2
Average (Bias1)	---	2.464E-2	-1.574E-2	1.736E-2	NaN	NaN	-1.076E-2
s (Bias1)	---	4.967E-3	1.329E-2	4.856E-2	0.000E+0	0.000E+0	1.739E-2
Average+3s (Bias1)	---	3.954E-2	2.413E-2	1.630E-1	NaN	NaN	4.141E-2
Average-3s (Bias1)	---	9.740E-3	-5.561E-2	-1.283E-1	NaN	NaN	-6.293E-2

7. Tf

Ta = 25°C ; +Vs = +3.3V ; 90% to 10% level

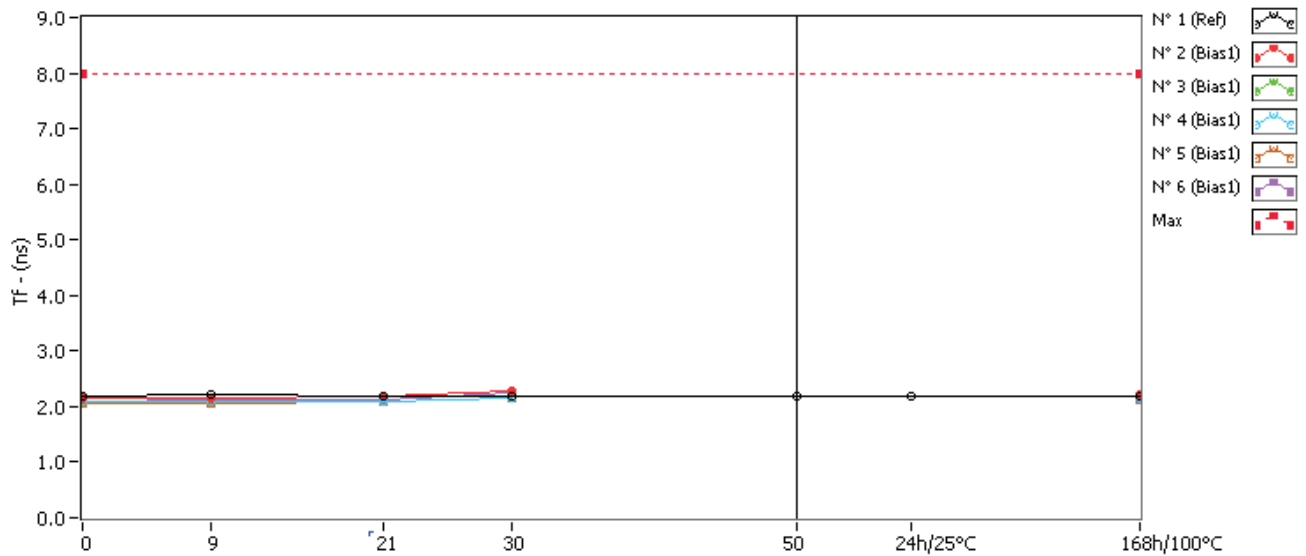

Tf. (ns) Max = 8.0

	0krad(Si)	9krad(Si)	21krad(Si)	30krad(Si)	50krad(Si)	24h/25°C	168h/100°C
N° 1 (Ref)	2.191	2.204	2.183	2.183	2.194	2.174	2.184
N° 2 (Bias1)	2.147	2.169	2.178	2.281	Not Measurable*	Not Measurable*	2.215
N° 3 (Bias1)	2.157	2.158	2.177	2.291	Not Measurable*	Not Measurable*	2.209
N° 4 (Bias1)	2.076	2.100	2.101	2.148	Not Measurable*	Not Measurable*	2.148
N° 5 (Bias1)	2.063	2.067	2.093	2.147	Not Measurable*	Not Measurable*	2.155
N° 6 (Bias1)	2.087	2.120	2.129	2.235	Not Measurable*	Not Measurable*	2.131

* The output don't switch ON.

Delta [Tf]

	0krad(Si)	9krad(Si)	21krad(Si)	30krad(Si)	50krad(Si)	24h/25°C	168h/100°C
N° 1 (Ref)	---	1.260E-2	-8.100E-3	-8.100E-3	2.500E-3	-1.680E-2	-6.900E-3
N° 2 (Bias1)	---	2.220E-2	3.090E-2	1.342E-1	NaN	NaN	6.840E-2
N° 3 (Bias1)	---	1.400E-3	2.050E-2	1.340E-1	NaN	NaN	5.190E-2
N° 4 (Bias1)	---	2.350E-2	2.450E-2	7.240E-2	NaN	NaN	7.210E-2
N° 5 (Bias1)	---	4.800E-3	3.080E-2	8.490E-2	NaN	NaN	9.260E-2
N° 6 (Bias1)	---	3.240E-2	4.140E-2	1.473E-1	NaN	NaN	4.410E-2
Average (Bias1)	---	1.686E-2	2.962E-2	1.146E-1	NaN	NaN	6.582E-2
s (Bias1)	---	1.322E-2	7.924E-3	3.351E-2	0.000E+0	0.000E+0	1.890E-2
Average+3s (Bias1)	---	5.651E-2	5.339E-2	2.151E-1	NaN	NaN	1.225E-1
Average-3s (Bias1)	---	-2.279E-2	5.847E-3	1.402E-2	NaN	NaN	9.121E-3

8. Dc

Ta = 25°C ; +Vs = +3.3V ; at 50% level

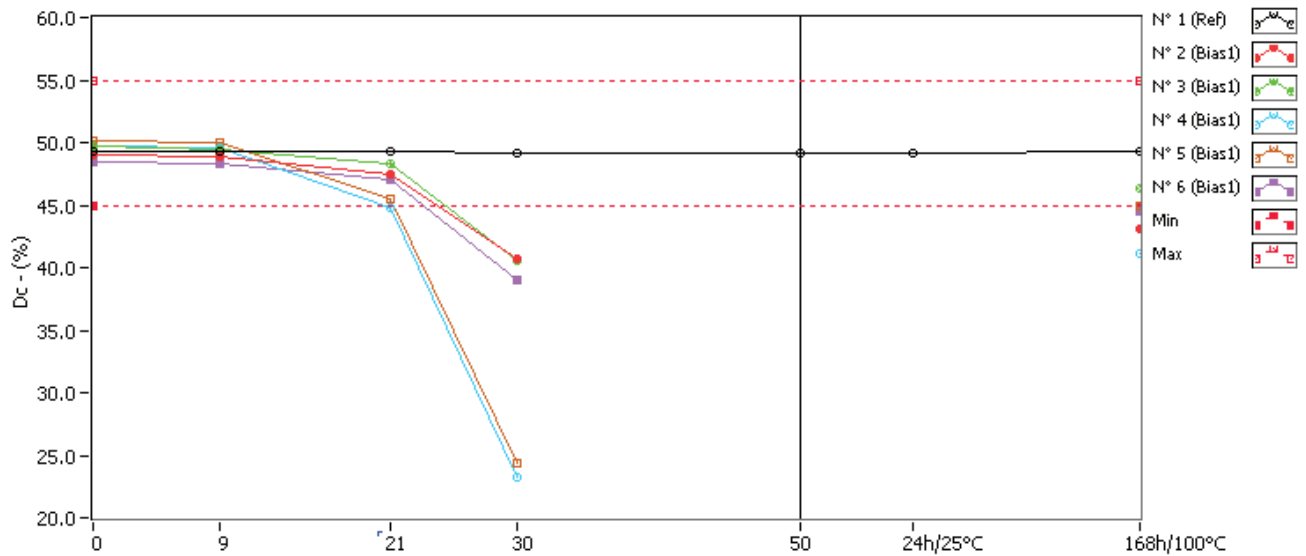

Dc . (%) **Min = 45.0 Max = 55.0**

	0krad(Si)	9krad(Si)	21krad(Si)	30krad(Si)	50krad(Si)	24h/25°C	168h/100°C
N° 1 (Ref)	49.240	49.245	49.238	49.208	49.211	49.211	49.234
N° 2 (Bias1)	49.056	48.929	47.413	40.735	Not Measurable*	Not Measurable*	43.073
N° 3 (Bias1)	49.685	49.449	48.321	40.556	Not Measurable*	Not Measurable*	46.390
N° 4 (Bias1)	49.650	49.514	44.794	23.242	Not Measurable*	Not Measurable*	41.157
N° 5 (Bias1)	50.081	49.957	45.533	24.404	Not Measurable*	Not Measurable*	44.928
N° 6 (Bias1)	48.382	48.255	47.087	39.041	Not Measurable*	Not Measurable*	44.576

* The output don't switch ON.

Delta [Dc]

	0krad(Si)	9krad(Si)	21krad(Si)	30krad(Si)	50krad(Si)	24h/25°C	168h/100°C
N° 1 (Ref)	---	5.500E-3	-1.900E-3	-3.210E-2	-2.890E-2	-2.870E-2	-5.300E-3
N° 2 (Bias1)	---	-1.270E-1	-1.643E+0	-8.321E+0	NaN	NaN	-5.983E+0
N° 3 (Bias1)	---	-2.361E-1	-1.364E+0	-9.129E+0	NaN	NaN	-3.295E+0
N° 4 (Bias1)	---	-1.352E-1	-4.856E+0	-2.641E+1	NaN	NaN	-8.493E+0
N° 5 (Bias1)	---	-1.245E-1	-4.549E+0	-2.568E+1	NaN	NaN	-5.153E+0
N° 6 (Bias1)	---	-1.269E-1	-1.295E+0	-9.341E+0	NaN	NaN	-3.806E+0
Average (Bias1)	---	-1.499E-1	-2.741E+0	-1.578E+1	NaN	NaN	-5.346E+0
s (Bias1)	---	4.834E-2	1.798E+0	9.384E+0	0.000E+0	0.000E+0	2.057E+0
Average+3s (Bias1)	---	-4.935E-3	2.653E+0	1.238E+1	NaN	NaN	8.250E-1
Average-3s (Bias1)	---	-2.949E-1	-8.135E+0	-4.393E+1	NaN	NaN	-1.152E+1

9. VIH

Ta = 25°C ; +Vs = +3.3V

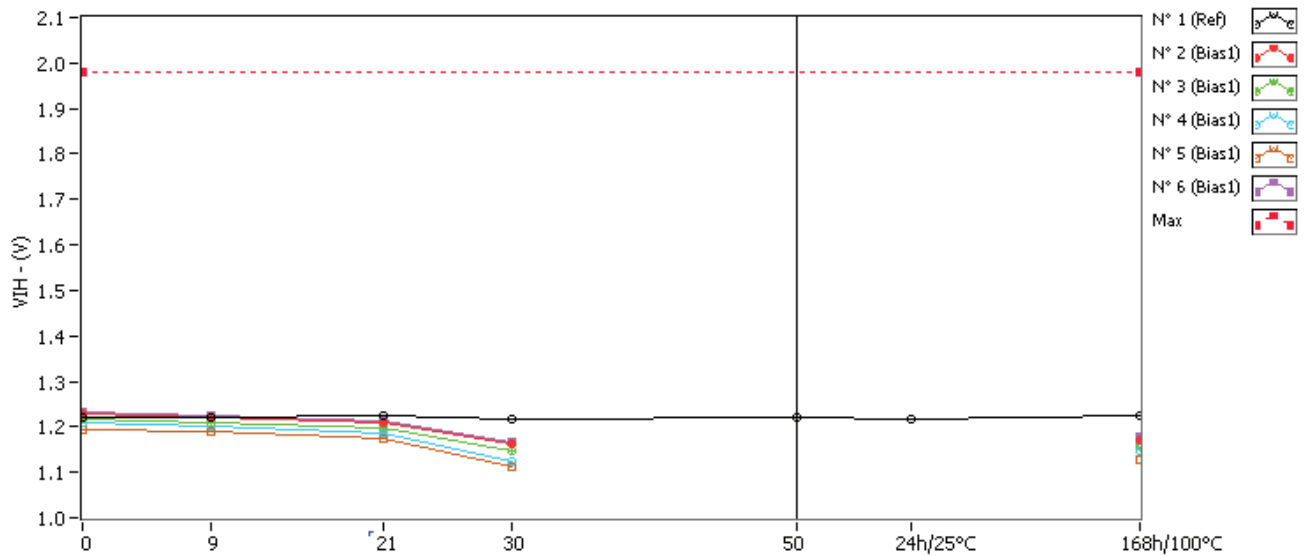

VIH . (V) Max = 1.98

	0krad(Si)	9krad(Si)	21krad(Si)	30krad(Si)	50krad(Si)	24h/25°C	168h/100°C
N° 1 (Ref)	1.221	1.222	1.223	1.218	1.219	1.218	1.224
N° 2 (Bias1)	1.228	1.222	1.210	1.163	Not Measurable*	Not Measurable*	1.172
N° 3 (Bias1)	1.216	1.210	1.196	1.147	Not Measurable*	Not Measurable*	1.157
N° 4 (Bias1)	1.209	1.203	1.187	1.126	Not Measurable*	Not Measurable*	1.147
N° 5 (Bias1)	1.194	1.188	1.174	1.111	Not Measurable*	Not Measurable*	1.129
N° 6 (Bias1)	1.231	1.226	1.214	1.167	Not Measurable*	Not Measurable*	1.179

* The output don't switch ON.

Delta [VIH]

	0krad(Si)	9krad(Si)	21krad(Si)	30krad(Si)	50krad(Si)	24h/25°C	168h/100°C
N° 1 (Ref)	---	9.000E-4	1.900E-3	-3.700E-3	-2.000E-3	-3.100E-3	2.500E-3
N° 2 (Bias1)	---	-5.900E-3	-1.770E-2	-6.550E-2	NaN	NaN	-5.640E-2
N° 3 (Bias1)	---	-6.300E-3	-2.020E-2	-6.980E-2	NaN	NaN	-5.910E-2
N° 4 (Bias1)	---	-5.600E-3	-2.160E-2	-8.310E-2	NaN	NaN	-6.190E-2
N° 5 (Bias1)	---	-5.100E-3	-1.920E-2	-8.220E-2	NaN	NaN	-6.490E-2
N° 6 (Bias1)	---	-5.500E-3	-1.740E-2	-6.420E-2	NaN	NaN	-5.240E-2
Average (Bias1)	---	-5.680E-3	-1.922E-2	-7.296E-2	NaN	NaN	-5.894E-2
s (Bias1)	---	4.494E-4	1.750E-3	9.091E-3	0.000E+0	0.000E+0	4.836E-3
Average+3s (Bias1)	---	-4.332E-3	-1.397E-2	-4.569E-2	NaN	NaN	-4.443E-2
Average-3s (Bias1)	---	-7.028E-3	-2.447E-2	-1.002E-1	NaN	NaN	-7.345E-2

10. VIL

Ta = 25°C ; +Vs = +3.3V

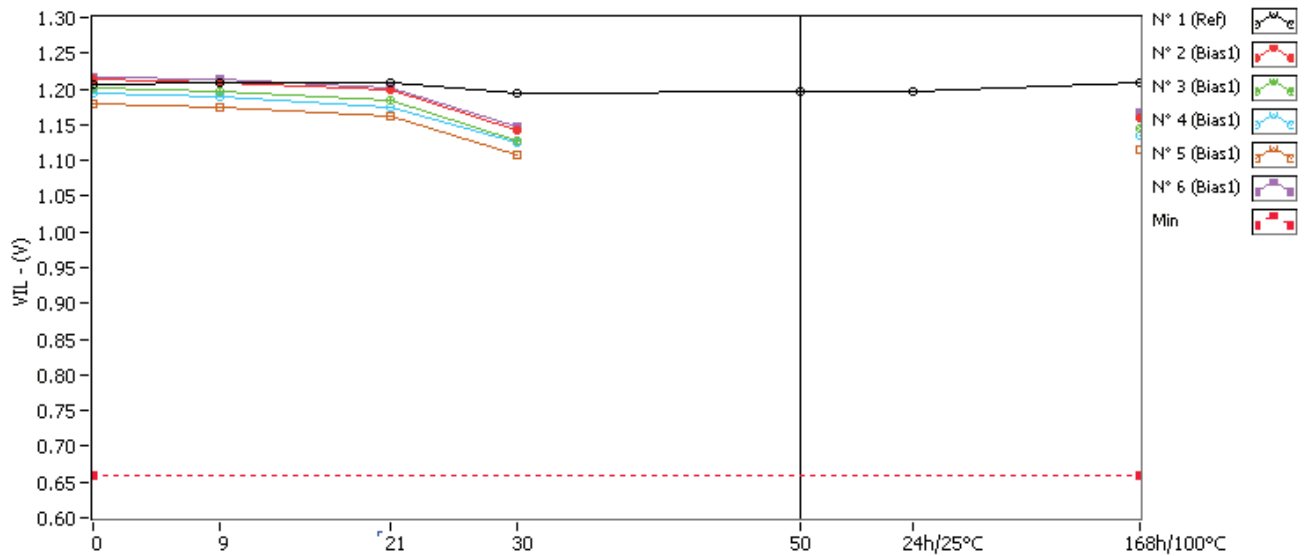

VIL . (V) Min = 0.66

	0krad(Si)	9krad(Si)	21krad(Si)	30krad(Si)	50krad(Si)	24h/25°C	168h/100°C
N° 1 (Ref)	1.206	1.209	1.210	1.193	1.197	1.197	1.209
N° 2 (Bias1)	1.214	1.210	1.198	1.143	Not Measurable*	Not Measurable*	1.159
N° 3 (Bias1)	1.202	1.197	1.184	1.127	Not Measurable*	Not Measurable*	1.144
N° 4 (Bias1)	1.194	1.190	1.175	1.124	Not Measurable*	Not Measurable*	1.134
N° 5 (Bias1)	1.179	1.175	1.162	1.108	Not Measurable*	Not Measurable*	1.116
N° 6 (Bias1)	1.217	1.214	1.202	1.148	Not Measurable*	Not Measurable*	1.166

* The output don't switch ON.

Delta [VIL]

	0krad(Si)	9krad(Si)	21krad(Si)	30krad(Si)	50krad(Si)	24h/25°C	168h/100°C
N° 1 (Ref)	---	2.300E-3	3.400E-3	-1.340E-2	-9.600E-3	-9.600E-3	2.300E-3
N° 2 (Bias1)	---	-4.000E-3	-1.530E-2	-7.100E-2	NaN	NaN	-5.410E-2
N° 3 (Bias1)	---	-4.600E-3	-1.820E-2	-7.510E-2	NaN	NaN	-5.780E-2
N° 4 (Bias1)	---	-3.900E-3	-1.910E-2	-6.970E-2	NaN	NaN	-5.990E-2
N° 5 (Bias1)	---	-3.300E-3	-1.680E-2	-7.070E-2	NaN	NaN	-6.320E-2
N° 6 (Bias1)	---	-3.400E-3	-1.520E-2	-6.890E-2	NaN	NaN	-5.150E-2
Average (Bias1)	---	-3.840E-3	-1.692E-2	-7.108E-2	NaN	NaN	-5.730E-2
s (Bias1)	---	5.225E-4	1.731E-3	2.396E-3	0.000E+0	0.000E+0	4.629E-3
Average+3s (Bias1)	---	-2.273E-3	-1.173E-2	-6.389E-2	NaN	NaN	-4.341E-2
Average-3s (Bias1)	---	-5.407E-3	-2.211E-2	-7.827E-2	NaN	NaN	-7.119E-2



**TOTAL IONIZING DOSE
TEST REPORT**

40MHz-CFPT9006

Ref: TRAD/TE/40MHz-CFPT9006/XXX1/ESA/BR/1207
Date: December 10th, 2012

Rev: 1

13. APPENDIX B : PARTS MODE2 TESTS RESULTS

Contents :

1 F	B-2
2 Fstab	B-3
3 Is	B-4
4 VOL	B-5
5 VOH	B-6
6 Tr	B-7
7 Tf	B-8
8 Dc	B-9
9 VIH	B-10
10 VIL	B-11

1. F

Ta = 25°C ; +Vs = +3.3V

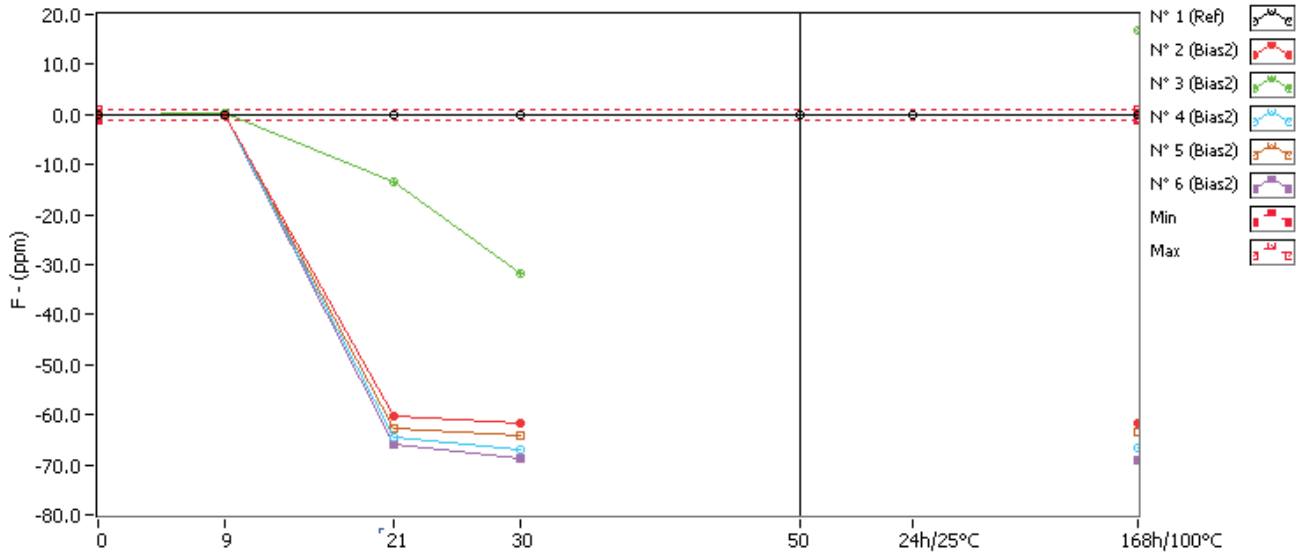

F . (ppm) Min = -1.0 Max = 1.0

	0krad(Si)	9krad(Si)	21krad(Si)	30krad(Si)	50krad(Si)	24h/25°C	168h/100°C
N° 1 (Ref)	0.025	0.025	0.050	0.025	0.025	0.000	0.050
N° 2 (Bias2)	-0.025	0.000	-60.275	-61.750	Not Measurable*	Not Measurable*	-61.650
N° 3 (Bias2)	0.100	0.150	-13.575	-31.925	Not Measurable*	Not Measurable*	16.800
N° 4 (Bias2)	0.000	0.100	-64.425	-66.925	Not Measurable*	Not Measurable*	-66.650
N° 5 (Bias2)	-0.100	-0.025	-62.750	-64.125	Not Measurable*	Not Measurable*	-63.375
N° 6 (Bias2)	-0.075	0.050	-66.000	-68.900	Not Measurable*	Not Measurable*	-69.050

* The output don't switch ON.

Delta [F]

	0krad(Si)	9krad(Si)	21krad(Si)	30krad(Si)	50krad(Si)	24h/25°C	168h/100°C
N° 1 (Ref)	---	0.000E+0	2.500E-2	0.000E+0	0.000E+0	-2.500E-2	2.500E-2
N° 2 (Bias2)	---	2.500E-2	-6.025E+1	-6.173E+1	NaN	NaN	-6.162E+1
N° 3 (Bias2)	---	5.000E-2	-1.367E+1	-3.202E+1	NaN	NaN	1.670E+1
N° 4 (Bias2)	---	1.000E-1	-6.442E+1	-6.692E+1	NaN	NaN	-6.665E+1
N° 5 (Bias2)	---	7.500E-2	-6.265E+1	-6.403E+1	NaN	NaN	-6.327E+1
N° 6 (Bias2)	---	1.250E-1	-6.592E+1	-6.883E+1	NaN	NaN	-6.897E+1
Average (Bias2)	---	7.500E-2	-5.339E+1	-5.870E+1	NaN	NaN	-4.877E+1
s (Bias2)	---	3.953E-2	2.230E+1	1.516E+1	0.000E+0	0.000E+0	3.671E+1
Average+3s (Bias2)	---	1.936E-1	1.351E+1	-1.323E+1	NaN	NaN	6.136E+1
Average-3s (Bias2)	---	-4.359E-2	-1.203E+2	-1.042E+2	NaN	NaN	-1.589E+2

2. Fstab

Ta = 25°C ; +2.97V < +Vs < +3.63V

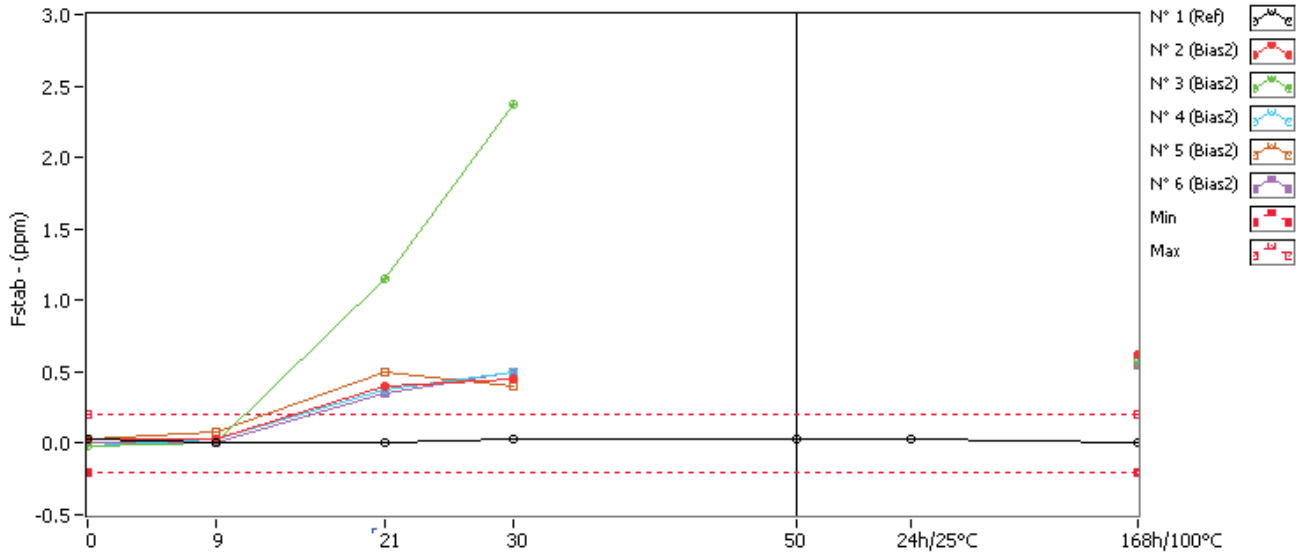

Fstab . (ppm) Min = -0.2 Max = 0.2

	0krad(Si)	9krad(Si)	21krad(Si)	30krad(Si)	50krad(Si)	24h/25°C	168h/100°C
N° 1 (Ref)	0.025	0.000	0.000	0.025	0.025	0.025	0.000
N° 2 (Bias2)	0.025	0.025	0.400	0.450	Not Measurable*	Not Measurable*	0.625
N° 3 (Bias2)	-0.025	0.000	1.150	2.375	Not Measurable*	Not Measurable*	0.575
N° 4 (Bias2)	-0.025	0.025	0.375	0.500	Not Measurable*	Not Measurable*	0.575
N° 5 (Bias2)	0.025	0.075	0.500	0.400	Not Measurable*	Not Measurable*	0.575
N° 6 (Bias2)	0.000	0.000	0.350	0.500	Not Measurable*	Not Measurable*	0.550

* The output don't switch ON.

Delta [Fstab]

	0krad(Si)	9krad(Si)	21krad(Si)	30krad(Si)	50krad(Si)	24h/25°C	168h/100°C
N° 1 (Ref)	---	-2.500E-2	-2.500E-2	0.000E+0	0.000E+0	0.000E+0	-2.500E-2
N° 2 (Bias2)	---	0.000E+0	3.750E-1	4.250E-1	NaN	NaN	6.000E-1
N° 3 (Bias2)	---	2.500E-2	1.175E+0	2.400E+0	NaN	NaN	6.000E-1
N° 4 (Bias2)	---	5.000E-2	4.000E-1	5.250E-1	NaN	NaN	6.000E-1
N° 5 (Bias2)	---	5.000E-2	4.750E-1	3.750E-1	NaN	NaN	5.500E-1
N° 6 (Bias2)	---	0.000E+0	3.500E-1	5.000E-1	NaN	NaN	5.500E-1
Average (Bias2)	---	2.500E-2	5.550E-1	8.450E-1	NaN	NaN	5.800E-1
s (Bias2)	---	2.500E-2	3.497E-1	8.713E-1	0.000E+0	0.000E+0	2.738E-2
Average+3s (Bias2)	---	1.000E-1	1.604E+0	3.459E+0	NaN	NaN	6.622E-1
Average-3s (Bias2)	---	-5.000E-2	-4.942E-1	-1.769E+0	NaN	NaN	4.979E-1

3. Is

Ta = 25°C ; +Vs = +3.3V

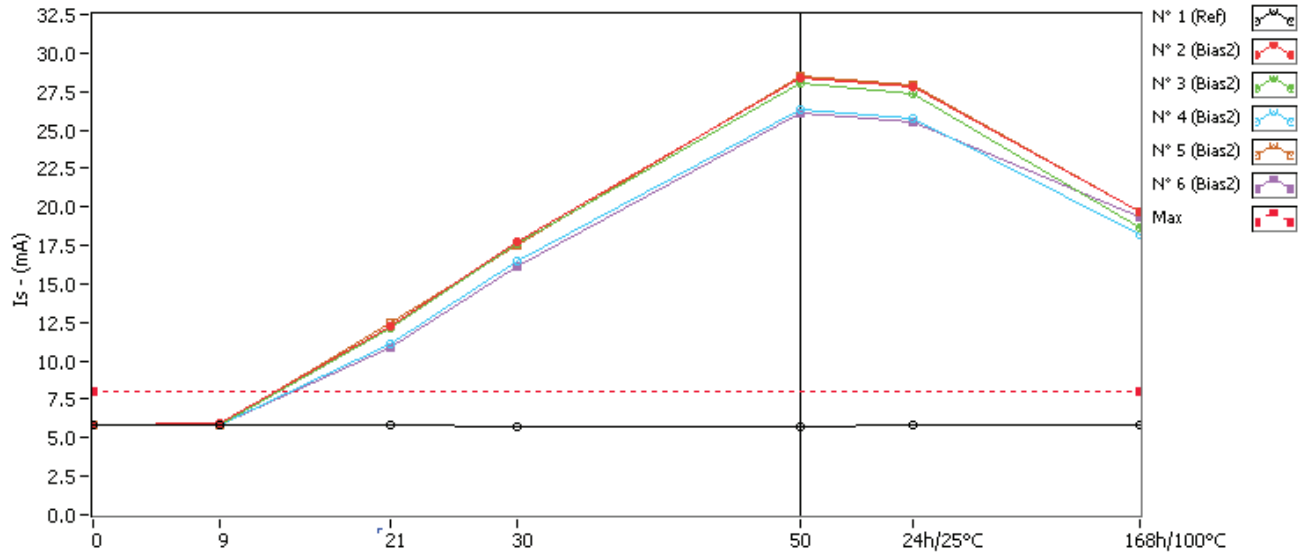

Is . (mA) Max = 8.0

	0krad(Si)	9krad(Si)	21krad(Si)	30krad(Si)	50krad(Si)	24h/25°C	168h/100°C
N° 1 (Ref)	5.830	5.835	5.815	5.753	5.754	5.784	5.822
N° 2 (Bias2)	5.854	5.898	12.252	17.727	28.418	27.865	19.683
N° 3 (Bias2)	5.826	5.865	12.186	17.667	27.987	27.366	18.642
N° 4 (Bias2)	5.794	5.816	11.113	16.460	26.351	25.765	18.221
N° 5 (Bias2)	5.811	5.869	12.429	17.551	28.534	27.965	19.677
N° 6 (Bias2)	5.808	5.827	10.905	16.103	26.106	25.563	19.335

Delta [Is]

	0krad(Si)	9krad(Si)	21krad(Si)	30krad(Si)	50krad(Si)	24h/25°C	168h/100°C
N° 1 (Ref)	---	5.635E-3	-1.467E-2	-7.642E-2	-7.605E-2	-4.538E-2	-8.055E-3
N° 2 (Bias2)	---	4.386E-2	6.398E+0	1.187E+1	2.256E+1	2.201E+1	1.383E+1
N° 3 (Bias2)	---	3.881E-2	6.360E+0	1.184E+1	2.216E+1	2.154E+1	1.282E+1
N° 4 (Bias2)	---	2.283E-2	5.319E+0	1.067E+1	2.056E+1	1.997E+1	1.243E+1
N° 5 (Bias2)	---	5.799E-2	6.618E+0	1.174E+1	2.272E+1	2.215E+1	1.387E+1
N° 6 (Bias2)	---	1.866E-2	5.096E+0	1.029E+1	2.030E+1	1.975E+1	1.353E+1
Average (Bias2)	---	3.643E-2	5.958E+0	1.128E+1	2.166E+1	2.109E+1	1.329E+1
s (Bias2)	---	1.602E-2	6.967E-1	7.458E-1	1.148E+0	1.142E+0	6.416E-1
Average+3s (Bias2)	---	8.448E-2	8.048E+0	1.352E+1	2.510E+1	2.451E+1	1.522E+1
Average-3s (Bias2)	---	-1.162E-2	3.868E+0	9.046E+0	1.822E+1	1.766E+1	1.137E+1

4. VOL

Ta = 25°C ; +Vs = +3.3V

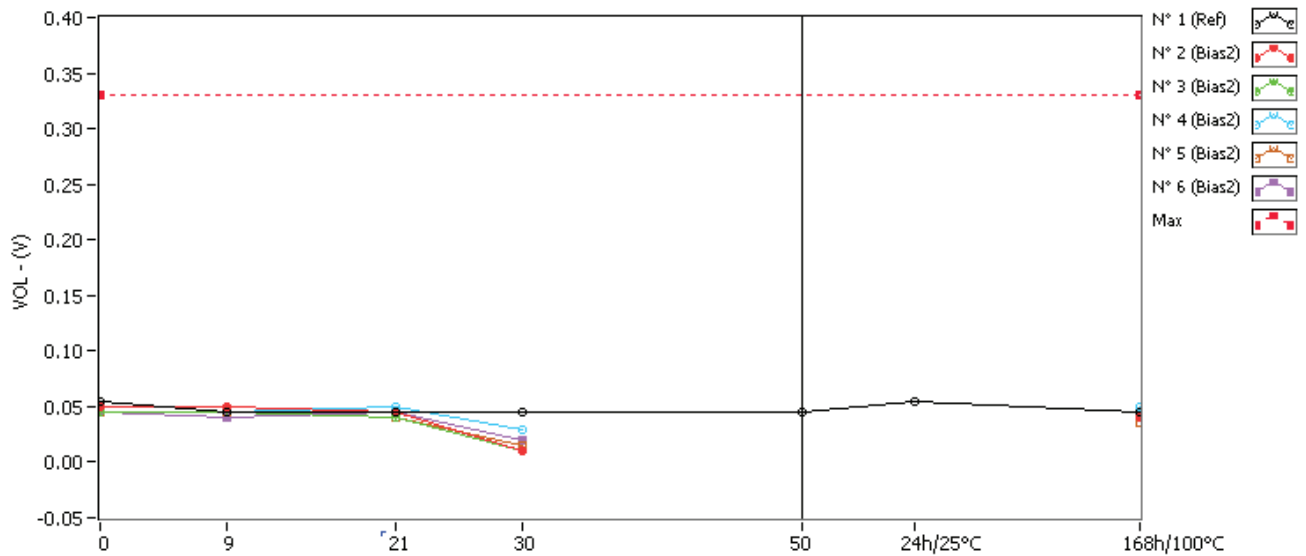

VOL . (V) Max = 0.33

	0krad(Si)	9krad(Si)	21krad(Si)	30krad(Si)	50krad(Si)	24h/25°C	168h/100°C
N° 1 (Ref)	0.055	0.045	0.045	0.045	0.045	0.055	0.045
N° 2 (Bias2)	0.050	0.050	0.045	0.010	Not Measurable*	Not Measurable*	0.040
N° 3 (Bias2)	0.045	0.045	0.040	0.010	Not Measurable*	Not Measurable*	0.040
N° 4 (Bias2)	0.055	0.045	0.050	0.030	Not Measurable*	Not Measurable*	0.050
N° 5 (Bias2)	0.045	0.045	0.040	0.015	Not Measurable*	Not Measurable*	0.035
N° 6 (Bias2)	0.045	0.040	0.045	0.020	Not Measurable*	Not Measurable*	0.040

* The output don't switch ON.

Delta [VOL]

	0krad(Si)	9krad(Si)	21krad(Si)	30krad(Si)	50krad(Si)	24h/25°C	168h/100°C
N° 1 (Ref)	---	-1.000E-2	-1.000E-2	-1.000E-2	-1.000E-2	0.000E+0	-1.000E-2
N° 2 (Bias2)	---	0.000E+0	-5.000E-3	-4.000E-2	NaN	NaN	-1.000E-2
N° 3 (Bias2)	---	0.000E+0	-5.000E-3	-3.500E-2	NaN	NaN	-5.000E-3
N° 4 (Bias2)	---	-1.000E-2	-5.000E-3	-2.500E-2	NaN	NaN	-5.000E-3
N° 5 (Bias2)	---	0.000E+0	-5.000E-3	-3.000E-2	NaN	NaN	-1.000E-2
N° 6 (Bias2)	---	-5.000E-3	0.000E+0	-2.500E-2	NaN	NaN	-5.000E-3
Average (Bias2)	---	-3.000E-3	-4.000E-3	-3.100E-2	NaN	NaN	-7.000E-3
s (Bias2)	---	4.472E-3	2.236E-3	6.519E-3	0.000E+0	0.000E+0	2.739E-3
Average+3s (Bias2)	---	1.042E-2	2.708E-3	-1.144E-2	NaN	NaN	1.216E-3
Average-3s (Bias2)	---	-1.642E-2	-1.071E-2	-5.056E-2	NaN	NaN	-1.522E-2

5. VOH

Ta = 25°C ; +Vs = +3.3V

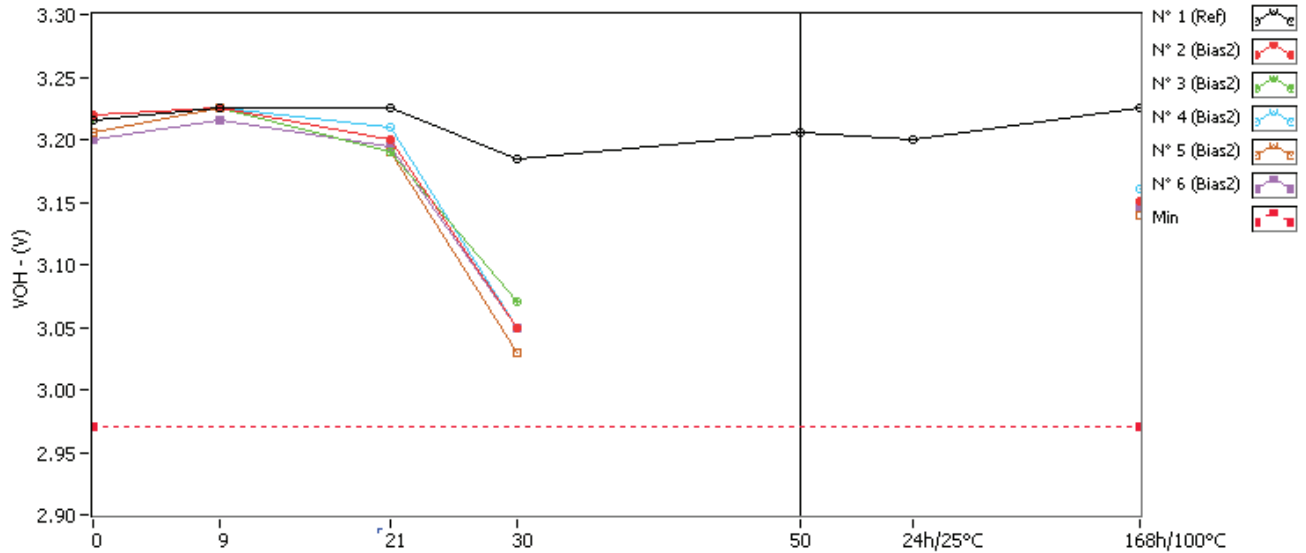

VOH . (V) Min = 2.97

	0krad(Si)	9krad(Si)	21krad(Si)	30krad(Si)	50krad(Si)	24h/25°C	168h/100°C
N° 1 (Ref)	3.215	3.225	3.225	3.185	3.205	3.200	3.225
N° 2 (Bias2)	3.220	3.225	3.200	3.050	Not Measurable*	Not Measurable*	3.150
N° 3 (Bias2)	3.215	3.225	3.190	3.070	Not Measurable*	Not Measurable*	3.150
N° 4 (Bias2)	3.215	3.225	3.210	3.050	Not Measurable*	Not Measurable*	3.160
N° 5 (Bias2)	3.205	3.225	3.190	3.030	Not Measurable*	Not Measurable*	3.140
N° 6 (Bias2)	3.200	3.215	3.195	3.050	Not Measurable*	Not Measurable*	3.145

* The output don't switch ON.

Delta [VOH]

	0krad(Si)	9krad(Si)	21krad(Si)	30krad(Si)	50krad(Si)	24h/25°C	168h/100°C
N° 1 (Ref)	---	1.000E-2	1.000E-2	-3.000E-2	-1.000E-2	-1.500E-2	1.000E-2
N° 2 (Bias2)	---	5.000E-3	-2.000E-2	-1.700E-1	NaN	NaN	-7.000E-2
N° 3 (Bias2)	---	1.000E-2	-2.500E-2	-1.450E-1	NaN	NaN	-6.500E-2
N° 4 (Bias2)	---	1.000E-2	-5.000E-3	-1.650E-1	NaN	NaN	-5.500E-2
N° 5 (Bias2)	---	2.000E-2	-1.500E-2	-1.750E-1	NaN	NaN	-6.500E-2
N° 6 (Bias2)	---	1.500E-2	-5.000E-3	-1.500E-1	NaN	NaN	-5.500E-2
Average (Bias2)	---	1.200E-2	-1.400E-2	-1.610E-1	NaN	NaN	-6.200E-2
s (Bias2)	---	5.701E-3	8.944E-3	1.294E-2	0.000E+0	0.000E+0	6.708E-3
Average+3s (Bias2)	---	2.910E-2	1.283E-2	-1.222E-1	NaN	NaN	-4.188E-2
Average-3s (Bias2)	---	-5.103E-3	-4.083E-2	-1.998E-1	NaN	NaN	-8.212E-2

6. Tr

Ta = 25°C ; +Vs = +3.3V ; 10% to 90% level

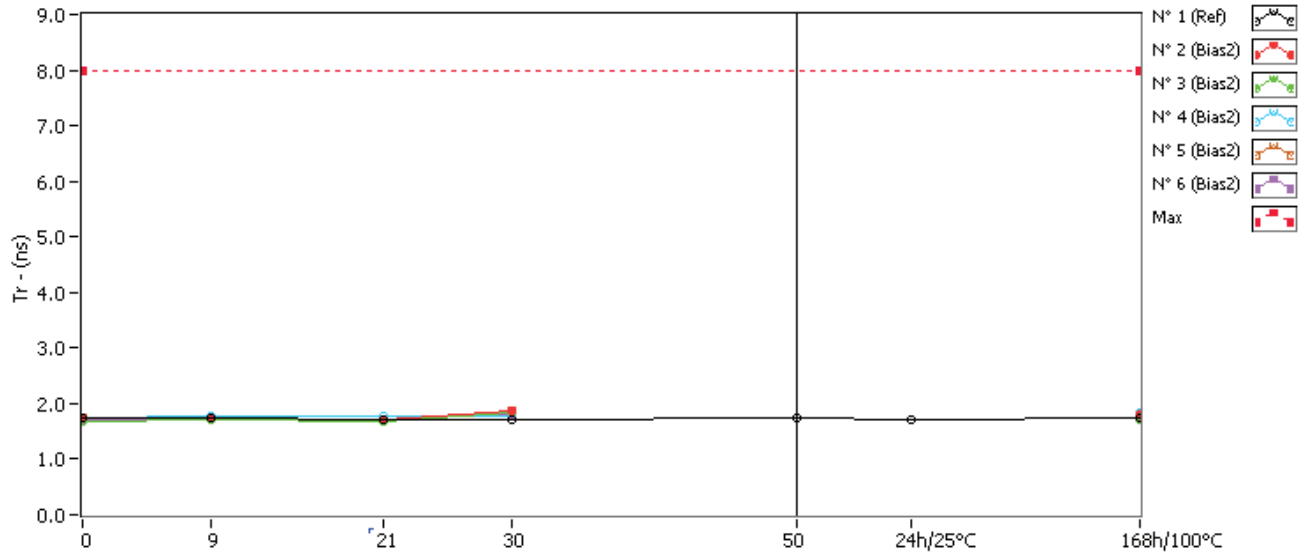

Tr . (ns) Max = 8.0

	0krad(Si)	9krad(Si)	21krad(Si)	30krad(Si)	50krad(Si)	24h/25°C	168h/100°C
N° 1 (Ref)	1.731	1.756	1.727	1.725	1.738	1.722	1.734
N° 2 (Bias2)	1.743	1.744	1.718	1.878	Not Measurable*	Not Measurable*	1.803
N° 3 (Bias2)	1.668	1.704	1.691	1.842	Not Measurable*	Not Measurable*	1.722
N° 4 (Bias2)	1.742	1.768	1.768	1.781	Not Measurable*	Not Measurable*	1.841
N° 5 (Bias2)	1.728	1.750	1.714	1.861	Not Measurable*	Not Measurable*	1.778
N° 6 (Bias2)	1.698	1.744	1.720	1.791	Not Measurable*	Not Measurable*	1.806

* The output don't switch ON.

Delta [Tr]

	0krad(Si)	9krad(Si)	21krad(Si)	30krad(Si)	50krad(Si)	24h/25°C	168h/100°C
N° 1 (Ref)	---	2.520E-2	-4.000E-3	-6.200E-3	7.600E-3	-9.100E-3	3.400E-3
N° 2 (Bias2)	---	9.000E-4	-2.510E-2	1.351E-1	NaN	NaN	6.010E-2
N° 3 (Bias2)	---	3.610E-2	2.300E-2	1.733E-1	NaN	NaN	5.420E-2
N° 4 (Bias2)	---	2.660E-2	2.660E-2	3.950E-2	NaN	NaN	9.870E-2
N° 5 (Bias2)	---	2.180E-2	-1.450E-2	1.324E-1	NaN	NaN	4.940E-2
N° 6 (Bias2)	---	4.520E-2	2.200E-2	9.240E-2	NaN	NaN	1.073E-1
Average (Bias2)	---	2.612E-2	6.400E-3	1.145E-1	NaN	NaN	7.394E-2
s (Bias2)	---	1.672E-2	2.427E-2	5.078E-2	0.000E+0	0.000E+0	2.697E-2
Average+3s (Bias2)	---	7.629E-2	7.921E-2	2.669E-1	NaN	NaN	1.548E-1
Average-3s (Bias2)	---	-2.405E-2	-6.641E-2	-3.781E-2	NaN	NaN	-6.968E-3

7. Tf

Ta = 25°C ; +Vs = +3.3V ; 90% to 10% level

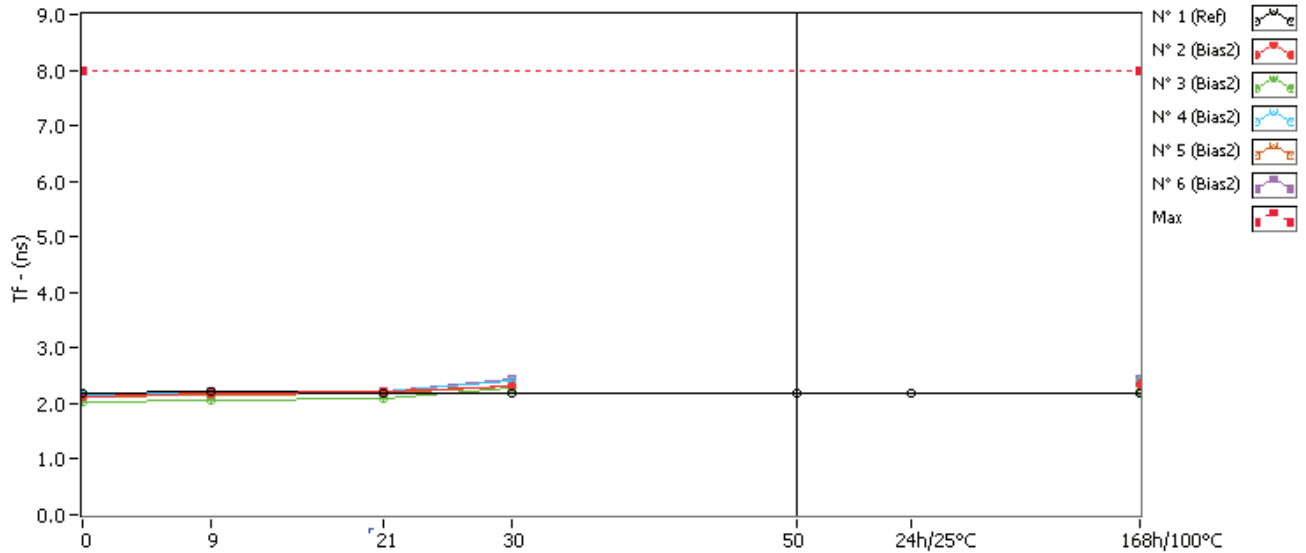

Tf. (ns) Max = 8.0

	0krad(Si)	9krad(Si)	21krad(Si)	30krad(Si)	50krad(Si)	24h/25°C	168h/100°C
N° 1 (Ref)	2.191	2.204	2.183	2.183	2.194	2.174	2.184
N° 2 (Bias2)	2.135	2.171	2.209	2.328	Not Measurable*	Not Measurable*	2.360
N° 3 (Bias2)	2.042	2.075	2.098	2.295	Not Measurable*	Not Measurable*	2.207
N° 4 (Bias2)	2.167	2.209	2.232	2.402	Not Measurable*	Not Measurable*	2.396
N° 5 (Bias2)	2.133	2.156	2.196	2.325	Not Measurable*	Not Measurable*	2.362
N° 6 (Bias2)	2.154	2.205	2.218	2.447	Not Measurable*	Not Measurable*	2.443

* The output don't switch ON.

Delta [Tf]

	0krad(Si)	9krad(Si)	21krad(Si)	30krad(Si)	50krad(Si)	24h/25°C	168h/100°C
N° 1 (Ref)	---	1.260E-2	-8.100E-3	-8.100E-3	2.500E-3	-1.680E-2	-6.900E-3
N° 2 (Bias2)	---	3.670E-2	7.470E-2	1.932E-1	NaN	NaN	2.251E-1
N° 3 (Bias2)	---	3.350E-2	5.660E-2	2.537E-1	NaN	NaN	1.653E-1
N° 4 (Bias2)	---	4.300E-2	6.540E-2	2.357E-1	NaN	NaN	2.291E-1
N° 5 (Bias2)	---	2.330E-2	6.250E-2	1.924E-1	NaN	NaN	2.286E-1
N° 6 (Bias2)	---	5.160E-2	6.410E-2	2.933E-1	NaN	NaN	2.892E-1
Average (Bias2)	---	3.762E-2	6.466E-2	2.337E-1	NaN	NaN	2.275E-1
s (Bias2)	---	1.057E-2	6.544E-3	4.273E-2	0.000E+0	0.000E+0	4.383E-2
Average+3s (Bias2)	---	6.934E-2	8.429E-2	3.618E-1	NaN	NaN	3.590E-1
Average-3s (Bias2)	---	5.897E-3	4.503E-2	1.055E-1	NaN	NaN	9.596E-2

8. Dc

Ta = 25°C ; +Vs = +3.3V ; at 50% level

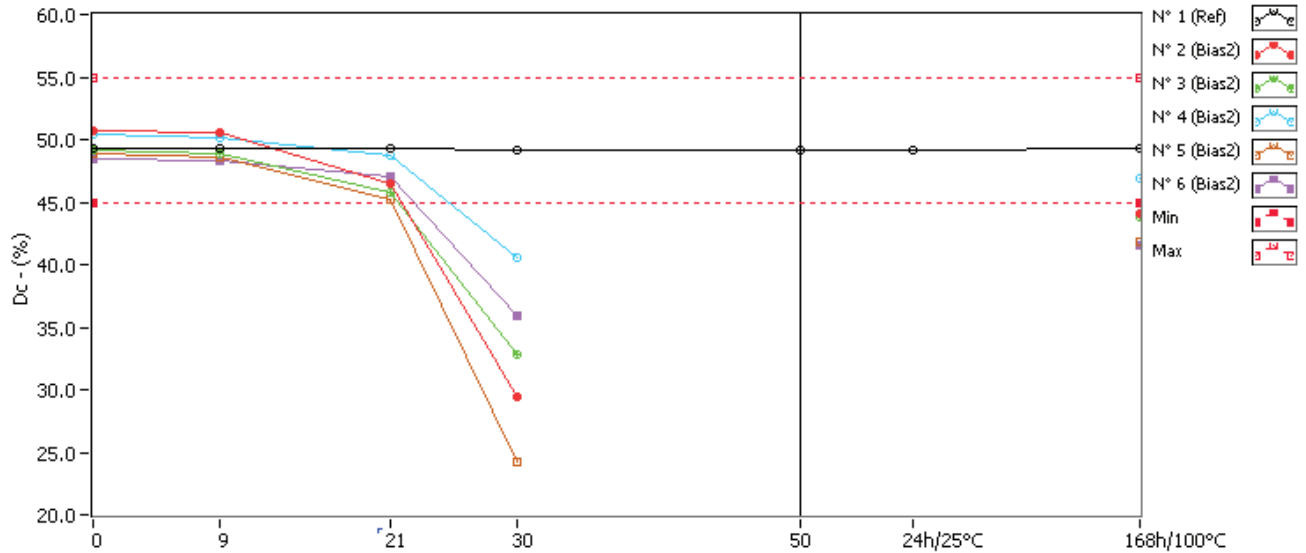

Dc . (%) Min = 45.0 Max = 55.0

	0krad(Si)	9krad(Si)	21krad(Si)	30krad(Si)	50krad(Si)	24h/25°C	168h/100°C
N° 1 (Ref)	49.240	49.245	49.238	49.208	49.211	49.211	49.234
N° 2 (Bias2)	50.757	50.515	46.465	29.441	Not Measurable*	Not Measurable*	44.113
N° 3 (Bias2)	49.113	48.868	45.743	32.845	Not Measurable*	Not Measurable*	43.738
N° 4 (Bias2)	50.373	50.173	48.767	40.546	Not Measurable*	Not Measurable*	46.959
N° 5 (Bias2)	48.929	48.599	45.204	24.189	Not Measurable*	Not Measurable*	41.800
N° 6 (Bias2)	48.521	48.283	47.005	35.953	Not Measurable*	Not Measurable*	41.613

* The output don't switch ON.

Delta [Dc]

	0krad(Si)	9krad(Si)	21krad(Si)	30krad(Si)	50krad(Si)	24h/25°C	168h/100°C
N° 1 (Ref)	---	5.500E-3	-1.900E-3	-3.210E-2	-2.890E-2	-2.870E-2	-5.300E-3
N° 2 (Bias2)	---	-2.418E-1	-4.291E+0	-2.132E+1	NaN	NaN	-6.643E+0
N° 3 (Bias2)	---	-2.450E-1	-3.369E+0	-1.627E+1	NaN	NaN	-5.375E+0
N° 4 (Bias2)	---	-1.999E-1	-1.606E+0	-9.827E+0	NaN	NaN	-3.414E+0
N° 5 (Bias2)	---	-3.301E-1	-3.725E+0	-2.474E+1	NaN	NaN	-7.128E+0
N° 6 (Bias2)	---	-2.373E-1	-1.516E+0	-1.257E+1	NaN	NaN	-6.908E+0
Average (Bias2)	---	-2.508E-1	-2.901E+0	-1.694E+1	NaN	NaN	-5.894E+0
s (Bias2)	---	4.790E-2	1.268E+0	6.127E+0	0.000E+0	0.000E+0	1.544E+0
Average+3s (Bias2)	---	-1.071E-1	9.011E-1	1.437E+0	NaN	NaN	-1.263E+0
Average-3s (Bias2)	---	-3.945E-1	-6.704E+0	-3.532E+1	NaN	NaN	-1.052E+1

9. VIH

Ta = 25°C ; +Vs = +3.3V

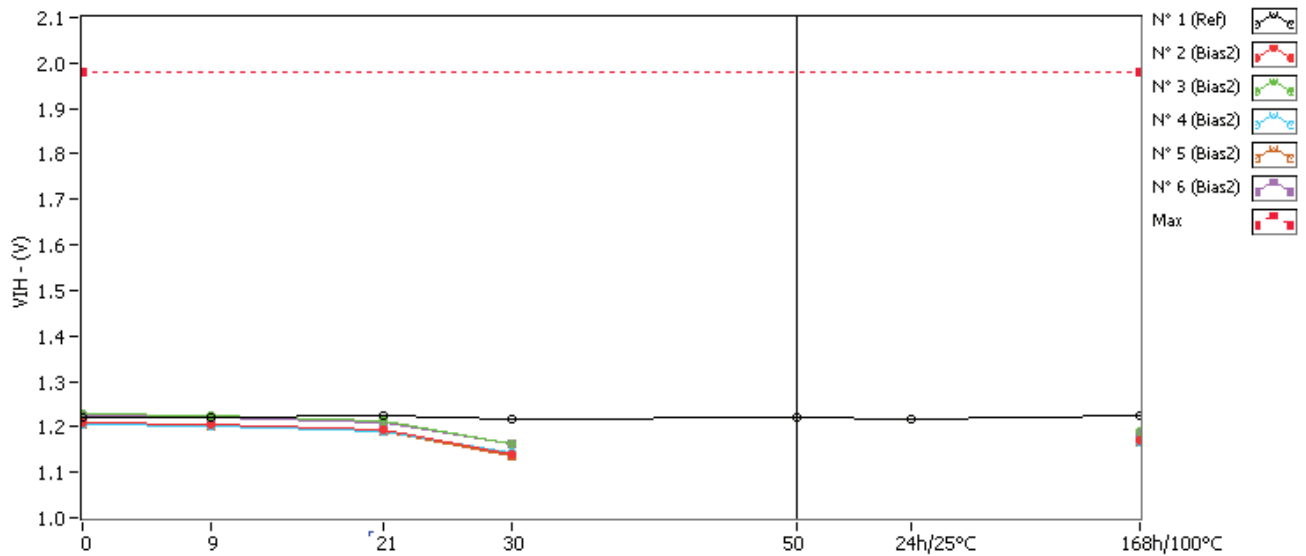

VIH . (V) Max = 1.98

	0krad(Si)	9krad(Si)	21krad(Si)	30krad(Si)	50krad(Si)	24h/25°C	168h/100°C
N° 1 (Ref)	1.221	1.222	1.223	1.218	1.219	1.218	1.224
N° 2 (Bias2)	1.209	1.205	1.193	1.141	Not Measurable*	Not Measurable*	1.171
N° 3 (Bias2)	1.230	1.225	1.214	1.162	Not Measurable*	Not Measurable*	1.191
N° 4 (Bias2)	1.207	1.202	1.191	1.144	Not Measurable*	Not Measurable*	1.168
N° 5 (Bias2)	1.206	1.201	1.190	1.135	Not Measurable*	Not Measurable*	1.166
N° 6 (Bias2)	1.224	1.219	1.210	1.163	Not Measurable*	Not Measurable*	1.186

* The output don't switch ON.

Delta [VIH]

	0krad(Si)	9krad(Si)	21krad(Si)	30krad(Si)	50krad(Si)	24h/25°C	168h/100°C
N° 1 (Ref)	---	9.000E-4	1.900E-3	-3.700E-3	-2.000E-3	-3.100E-3	2.500E-3
N° 2 (Bias2)	---	-4.100E-3	-1.580E-2	-6.790E-2	NaN	NaN	-3.780E-2
N° 3 (Bias2)	---	-5.000E-3	-1.600E-2	-6.740E-2	NaN	NaN	-3.880E-2
N° 4 (Bias2)	---	-4.900E-3	-1.610E-2	-6.300E-2	NaN	NaN	-3.900E-2
N° 5 (Bias2)	---	-5.600E-3	-1.620E-2	-7.130E-2	NaN	NaN	-4.030E-2
N° 6 (Bias2)	---	-5.300E-3	-1.490E-2	-6.140E-2	NaN	NaN	-3.830E-2
Average (Bias2)	---	-4.980E-3	-1.580E-2	-6.620E-2	NaN	NaN	-3.884E-2
s (Bias2)	---	5.630E-4	5.244E-4	3.988E-3	0.000E+0	0.000E+0	9.397E-4
Average+3s (Bias2)	---	-3.291E-3	-1.423E-2	-5.424E-2	NaN	NaN	-3.602E-2
Average-3s (Bias2)	---	-6.669E-3	-1.737E-2	-7.816E-2	NaN	NaN	-4.166E-2

10. VIL

Ta = 25°C ; +Vs = +3.3V

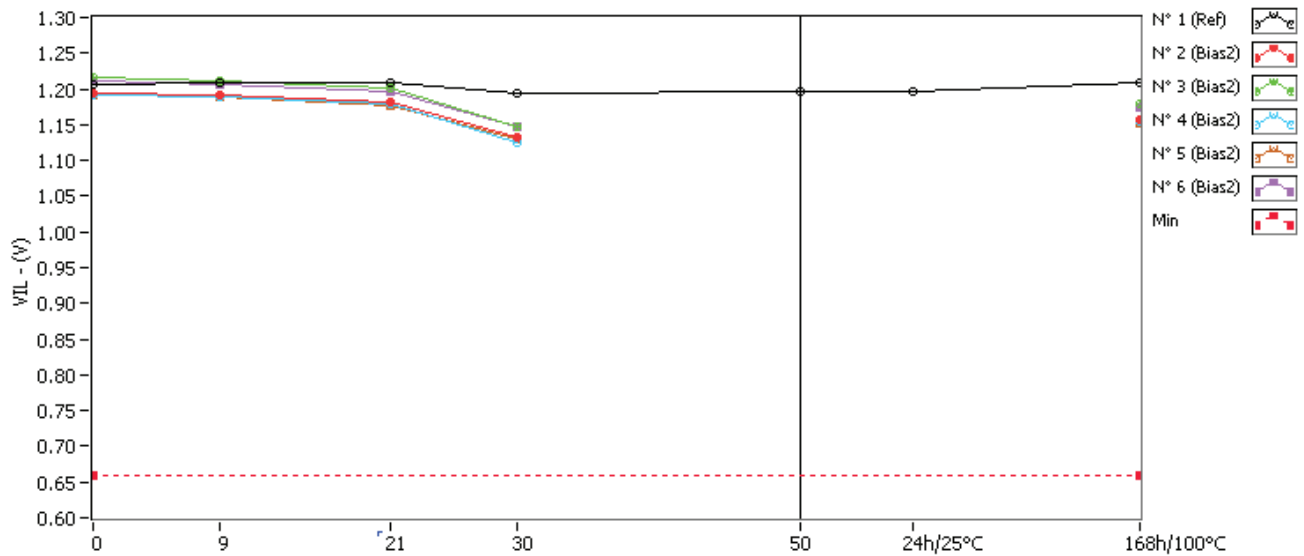

VIL . (V)

Min = 0.66

	0krad(Si)	9krad(Si)	21krad(Si)	30krad(Si)	50krad(Si)	24h/25°C	168h/100°C
N° 1 (Ref)	1.206	1.209	1.210	1.193	1.197	1.197	1.209
N° 2 (Bias2)	1.194	1.192	1.181	1.133	Not Measurable*	Not Measurable*	1.158
N° 3 (Bias2)	1.215	1.212	1.202	1.148	Not Measurable*	Not Measurable*	1.178
N° 4 (Bias2)	1.192	1.189	1.178	1.125	Not Measurable*	Not Measurable*	1.154
N° 5 (Bias2)	1.192	1.188	1.178	1.131	Not Measurable*	Not Measurable*	1.153
N° 6 (Bias2)	1.210	1.207	1.197	1.146	Not Measurable*	Not Measurable*	1.174

* The output don't switch ON.

Delta [VIL]

	0krad(Si)	9krad(Si)	21krad(Si)	30krad(Si)	50krad(Si)	24h/25°C	168h/100°C
N° 1 (Ref)	---	2.300E-3	3.400E-3	-1.340E-2	-9.600E-3	-9.600E-3	2.300E-3
N° 2 (Bias2)	---	-2.200E-3	-1.280E-2	-6.060E-2	NaN	NaN	-3.580E-2
N° 3 (Bias2)	---	-3.000E-3	-1.340E-2	-6.710E-2	NaN	NaN	-3.740E-2
N° 4 (Bias2)	---	-3.300E-3	-1.380E-2	-6.700E-2	NaN	NaN	-3.750E-2
N° 5 (Bias2)	---	-3.700E-3	-1.390E-2	-6.110E-2	NaN	NaN	-3.850E-2
N° 6 (Bias2)	---	-3.400E-3	-1.290E-2	-6.380E-2	NaN	NaN	-3.640E-2
Average (Bias2)	---	-3.120E-3	-1.336E-2	-6.392E-2	NaN	NaN	-3.712E-2
s (Bias2)	---	5.718E-4	5.030E-4	3.106E-3	0.000E+0	0.000E+0	1.047E-3
Average+3s (Bias2)	---	-1.404E-3	-1.185E-2	-5.460E-2	NaN	NaN	-3.398E-2
Average-3s (Bias2)	---	-4.836E-3	-1.487E-2	-7.324E-2	NaN	NaN	-4.026E-2



**TOTAL IONIZING DOSE
TEST REPORT**

40MHz-CFPT9006

Ref: TRAD/TE/40MHz-CFPT9006/XXX1/ESA/BR/1207
Date: December 10th, 2012

Rev: 1

14. APPENDIX C : PARTS OFF TESTS RESULTS

Contents :

1 F	C-2
2 Fstab	C-3
3 Is	C-4
4 VOL	C-5
5 VOH	C-6
6 Tr	C-7
7 Tf	C-8
8 Dc	C-9
9 VIH	C-10
10 VIL	C-11

1. F

Ta = 25°C ; +Vs = +3.3V

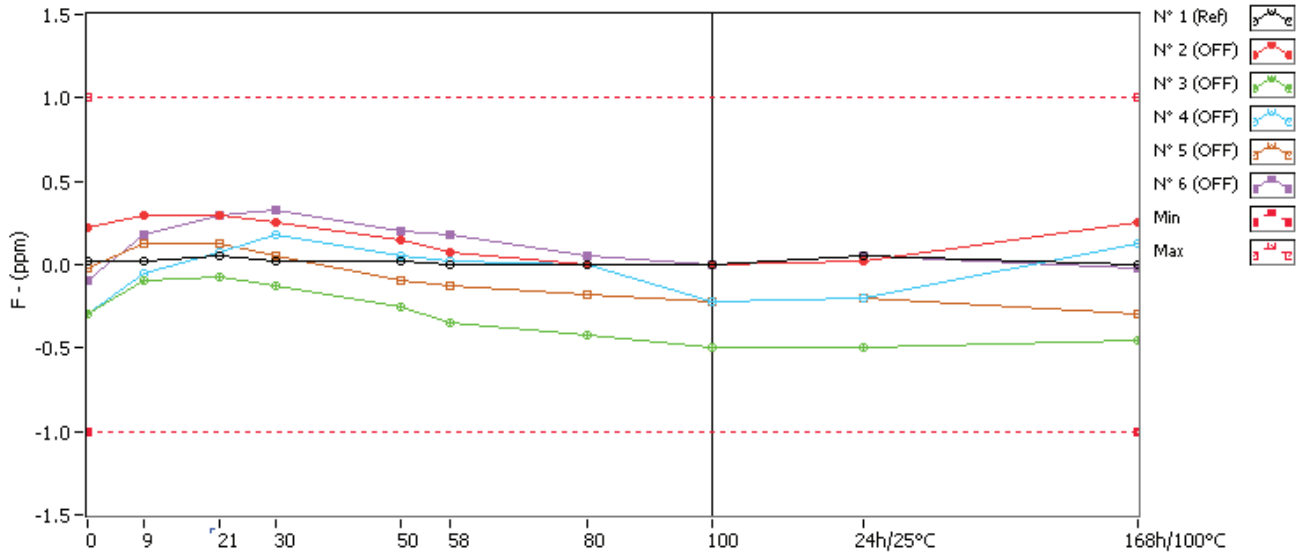

F. (ppm) Min = -1.0 Max = 1.0

	0krad(Si)	9krad(Si)	21krad(Si)	30krad(Si)	50krad(Si)	58krad(Si)	80krad(Si)	100krad(Si)	24h/25°C	168h/100°C
N° 1 (Ref)	0.025	0.025	0.050	0.025	0.025	0.000	0.000	0.000	0.050	0.000
N° 2 (OFF)	0.225	0.300	0.300	0.250	0.150	0.075	0.000	0.000	0.025	0.250
N° 3 (OFF)	-0.300	-0.100	-0.075	-0.125	-0.250	-0.350	-0.425	-0.500	-0.500	-0.450
N° 4 (OFF)	-0.300	-0.050	0.075	0.175	0.050	0.025	0.000	-0.225	-0.200	0.125
N° 5 (OFF)	-0.025	0.125	0.125	0.050	-0.100	-0.125	-0.175	-0.225	-0.200	-0.300
N° 6 (OFF)	-0.100	0.175	0.300	0.325	0.200	0.175	0.050	0.000	0.050	-0.025

Delta [F]

	0krad(Si)	9krad(Si)	21krad(Si)	30krad(Si)	50krad(Si)	58krad(Si)	80krad(Si)	100krad(Si)	24h/25°C	168h/100°C
N° 1 (Ref)	---	0.000E+0	2.500E-2	0.000E+0	0.000E+0	-2.500E-2	-2.500E-2	-2.500E-2	2.500E-2	-2.500E-2
N° 2 (OFF)	---	7.500E-2	7.500E-2	2.500E-2	-7.500E-2	-1.500E-1	-2.250E-1	-2.250E-1	-2.000E-1	2.500E-2
N° 3 (OFF)	---	2.000E-1	2.250E-1	1.750E-1	5.000E-2	-5.000E-2	-1.250E-1	-2.000E-1	-2.000E-1	-1.500E-1
N° 4 (OFF)	---	2.500E-1	3.750E-1	4.750E-1	3.500E-1	3.250E-1	3.000E-1	7.500E-2	1.000E-1	4.250E-1
N° 5 (OFF)	---	1.500E-1	1.500E-1	7.500E-2	-7.500E-2	-1.000E-1	-1.500E-1	-2.000E-1	-1.750E-1	-2.750E-1
N° 6 (OFF)	---	2.750E-1	4.000E-1	4.250E-1	3.000E-1	2.750E-1	1.500E-1	1.000E-1	1.500E-1	7.500E-2
Average (OFF)	---	1.900E-1	2.450E-1	2.350E-1	1.100E-1	6.000E-2	-1.000E-2	-9.000E-2	-6.500E-2	2.000E-2
s (OFF)	---	8.023E-2	1.408E-1	2.043E-1	2.036E-1	2.226E-1	2.240E-1	1.626E-1	1.746E-1	2.660E-1
Average+3s (OFF)	---	4.307E-1	6.673E-1	8.480E-1	7.207E-1	7.279E-1	6.621E-1	3.978E-1	4.589E-1	8.180E-1
Average-3s (OFF)	---	-5.070E-2	-1.773E-1	-3.780E-1	-5.007E-1	-6.079E-1	-6.821E-1	-5.778E-1	-5.889E-1	-7.780E-1

2. Fstab

Ta = 25°C ; +2.97V < +Vs < +3.63V

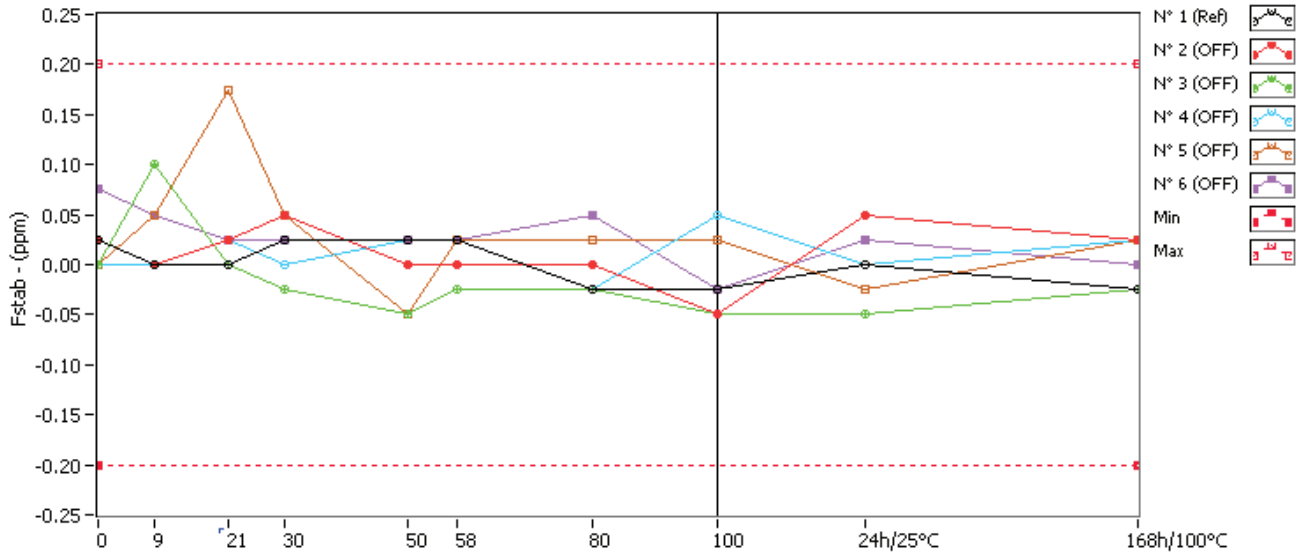

Fstab . (ppm) Min = -0.2 Max = 0.2

	0krad(Si)	9krad(Si)	21krad(Si)	30krad(Si)	50krad(Si)	58krad(Si)	80krad(Si)	100krad(Si)	24h/25°C	168h/100°C
N° 1 (Ref)	0.025	0.000	0.000	0.025	0.025	0.025	-0.025	-0.025	0.000	-0.025
N° 2 (OFF)	0.025	0.000	0.025	0.050	0.000	0.000	0.000	-0.050	0.050	0.025
N° 3 (OFF)	0.000	0.100	0.000	-0.025	-0.050	-0.025	-0.025	-0.050	-0.050	-0.025
N° 4 (OFF)	0.000	0.000	0.025	0.000	0.025	0.025	-0.025	0.050	0.000	0.025
N° 5 (OFF)	0.000	0.050	0.175	0.050	-0.050	0.025	0.025	0.025	-0.025	0.025
N° 6 (OFF)	0.075	0.050	0.025	0.025	0.025	0.025	0.050	-0.025	0.025	0.000

Delta [Fstab]

	0krad(Si)	9krad(Si)	21krad(Si)	30krad(Si)	50krad(Si)	58krad(Si)	80krad(Si)	100krad(Si)	24h/25°C	168h/100°C
N° 1 (Ref)	---	-2.500E-2	-2.500E-2	0.000E+0	0.000E+0	0.000E+0	-5.000E-2	-5.000E-2	-2.500E-2	-5.000E-2
N° 2 (OFF)	---	-2.500E-2	0.000E+0	2.500E-2	-2.500E-2	-2.500E-2	-2.500E-2	-7.500E-2	2.500E-2	0.000E+0
N° 3 (OFF)	---	1.000E-1	0.000E+0	-2.500E-2	-5.000E-2	-2.500E-2	-2.500E-2	-5.000E-2	-5.000E-2	-2.500E-2
N° 4 (OFF)	---	0.000E+0	2.500E-2	0.000E+0	2.500E-2	2.500E-2	-2.500E-2	5.000E-2	0.000E+0	2.500E-2
N° 5 (OFF)	---	5.000E-2	1.750E-1	5.000E-2	-5.000E-2	2.500E-2	2.500E-2	2.500E-2	-2.500E-2	2.500E-2
N° 6 (OFF)	---	-2.500E-2	-5.000E-2	-5.000E-2	-5.000E-2	-5.000E-2	-2.500E-2	-1.000E-1	-5.000E-2	-7.500E-2
Average (OFF)	---	2.000E-2	3.000E-2	-6.000E-9	-3.000E-2	-1.000E-2	-1.500E-2	-3.000E-2	-2.000E-2	-1.000E-2
s (OFF)	---	5.420E-2	8.551E-2	3.953E-2	3.260E-2	3.354E-2	2.236E-2	6.471E-2	3.260E-2	4.183E-2
Average+3s (OFF)	---	1.826E-1	2.865E-1	1.186E-1	6.779E-2	9.062E-2	5.208E-2	1.641E-1	7.779E-2	1.155E-1
Average-3s (OFF)	---	-1.426E-1	-2.265E-1	-1.186E-1	-1.278E-1	-1.106E-1	-8.208E-2	-2.241E-1	-1.178E-1	-1.355E-1

3. Is

Ta = 25°C ; +Vs = +3.3V

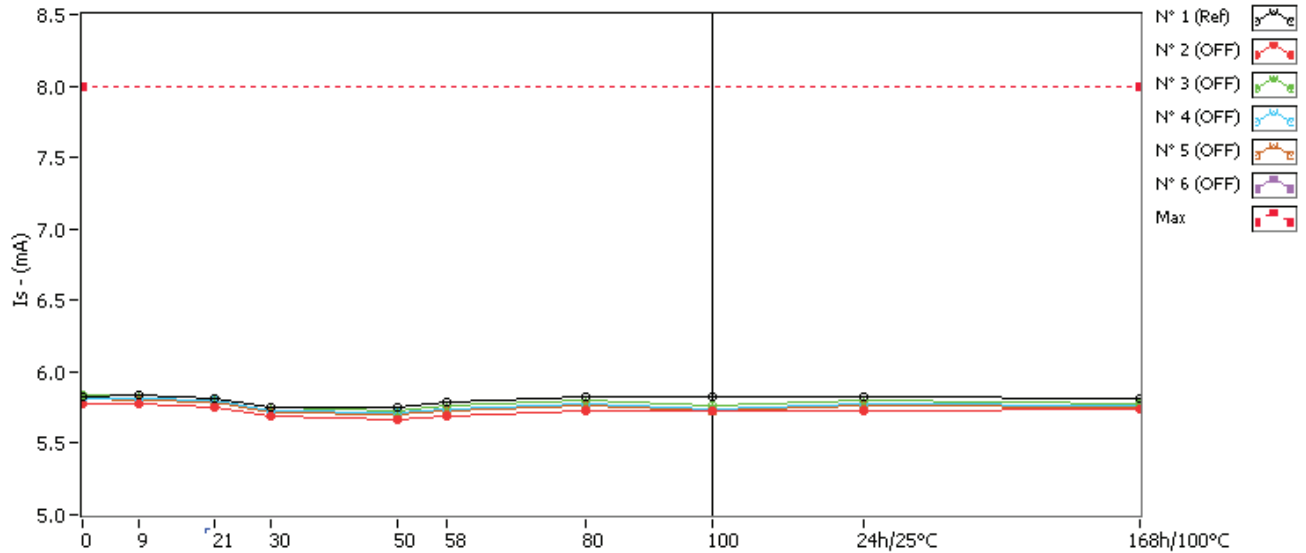

Is . (mA) Max = 8.0

	0krad(Si)	9krad(Si)	21krad(Si)	30krad(Si)	50krad(Si)	58krad(Si)	80krad(Si)	100krad(Si)	24h/25°C	168h/100°C
N° 1 (Ref)	5.830	5.835	5.815	5.753	5.754	5.784	5.824	5.824	5.822	5.818
N° 2 (OFF)	5.777	5.770	5.752	5.687	5.668	5.694	5.727	5.727	5.723	5.737
N° 3 (OFF)	5.839	5.835	5.818	5.753	5.733	5.765	5.797	5.758	5.796	5.775
N° 4 (OFF)	5.818	5.813	5.796	5.731	5.713	5.743	5.777	5.739	5.777	5.767
N° 5 (OFF)	5.808	5.804	5.784	5.718	5.700	5.730	5.761	5.725	5.762	5.754
N° 6 (OFF)	5.814	5.809	5.791	5.725	5.704	5.733	5.766	5.724	5.762	5.757

Delta [Is]

	0krad(Si)	9krad(Si)	21krad(Si)	30krad(Si)	50krad(Si)	58krad(Si)	80krad(Si)	100krad(Si)	24h/25°C	168h/100°C
N° 1 (Ref)	---	5.635E-3	-1.467E-2	-7.642E-2	-7.605E-2	-4.538E-2	-5.811E-3	-5.811E-3	-8.055E-3	-1.217E-2
N° 2 (OFF)	---	-6.729E-3	-2.479E-2	-9.044E-2	-1.088E-1	-8.334E-2	-5.029E-2	-5.029E-2	-5.434E-2	-3.972E-2
N° 3 (OFF)	---	-4.495E-3	-2.119E-2	-8.602E-2	-1.066E-1	-7.465E-2	-4.264E-2	-8.140E-2	-4.301E-2	-6.413E-2
N° 4 (OFF)	---	-4.671E-3	-2.229E-2	-8.688E-2	-1.044E-1	-7.453E-2	-4.060E-2	-7.862E-2	-4.065E-2	-5.061E-2
N° 5 (OFF)	---	-4.267E-3	-2.364E-2	-8.971E-2	-1.084E-1	-7.841E-2	-4.654E-2	-8.305E-2	-4.577E-2	-5.367E-2
N° 6 (OFF)	---	-5.567E-3	-2.354E-2	-8.888E-2	-1.103E-1	-8.137E-2	-4.803E-2	-8.996E-2	-5.215E-2	-5.744E-2
Average (OFF)	---	-5.146E-3	-2.309E-2	-8.838E-2	-1.077E-1	-7.846E-2	-4.562E-2	-7.666E-2	-4.718E-2	-5.311E-2
s (OFF)	---	1.013E-3	1.382E-3	1.876E-3	2.248E-3	3.947E-3	3.955E-3	1.533E-2	5.874E-3	9.029E-3
Average+3s (OFF)	---	-2.107E-3	-1.894E-2	-8.276E-2	-1.009E-1	-6.662E-2	-3.376E-2	-3.069E-2	-2.956E-2	-2.603E-2
Average-3s (OFF)	---	-8.185E-3	-2.724E-2	-9.401E-2	-1.144E-1	-9.030E-2	-5.748E-2	-1.226E-1	-6.480E-2	-8.020E-2

4. VOL

Ta = 25°C ; +Vs = +3.3V

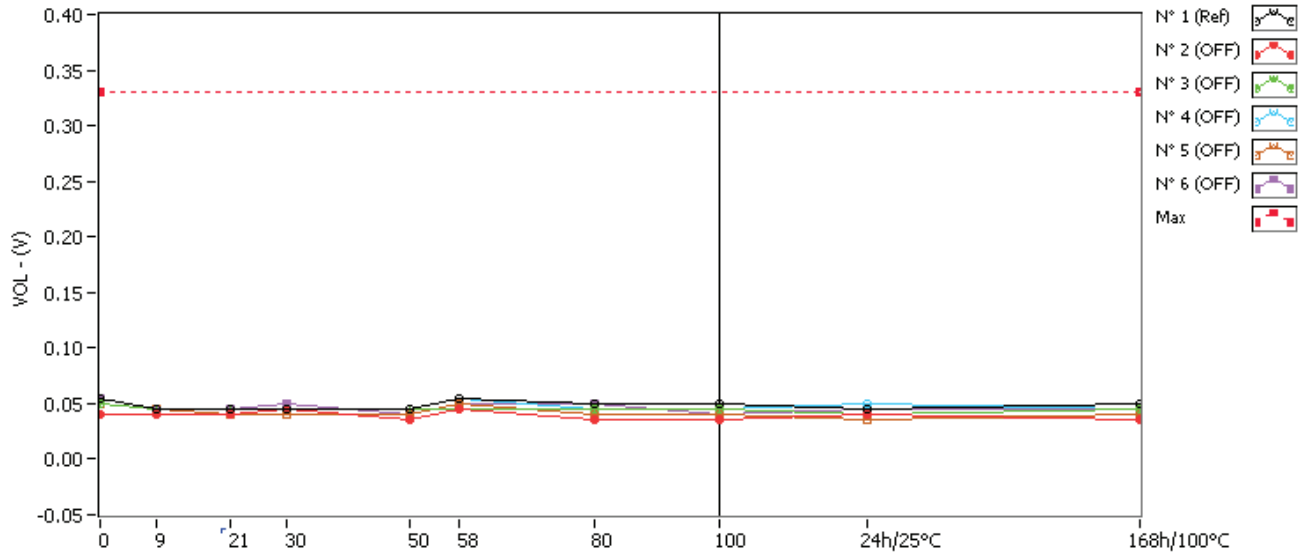

VOL . (V)

Max = 0.33

	0krad(Si)	9krad(Si)	21krad(Si)	30krad(Si)	50krad(Si)	58krad(Si)	80krad(Si)	100krad(Si)	24h/25°C	168h/100°C
N° 1 (Ref)	0.055	0.045	0.045	0.045	0.045	0.055	0.050	0.050	0.045	0.050
N° 2 (OFF)	0.040	0.040	0.040	0.045	0.035	0.045	0.035	0.035	0.040	0.035
N° 3 (OFF)	0.050	0.045	0.045	0.045	0.045	0.045	0.045	0.045	0.040	0.045
N° 4 (OFF)	0.055	0.045	0.045	0.045	0.045	0.055	0.045	0.045	0.050	0.045
N° 5 (OFF)	0.050	0.045	0.040	0.040	0.040	0.050	0.040	0.040	0.035	0.040
N° 6 (OFF)	0.055	0.045	0.045	0.050	0.040	0.050	0.050	0.040	0.045	0.045

Delta [VOL]

	0krad(Si)	9krad(Si)	21krad(Si)	30krad(Si)	50krad(Si)	58krad(Si)	80krad(Si)	100krad(Si)	24h/25°C	168h/100°C
N° 1 (Ref)	---	-1.000E-2	-1.000E-2	-1.000E-2	-1.000E-2	0.000E+0	-5.000E-3	-5.000E-3	-1.000E-2	-5.000E-3
N° 2 (OFF)	---	0.000E+0	0.000E+0	5.000E-3	-5.000E-3	5.000E-3	-5.000E-3	-5.000E-3	0.000E+0	-5.000E-3
N° 3 (OFF)	---	-5.000E-3	-5.000E-3	-5.000E-3	-5.000E-3	-5.000E-3	-5.000E-3	-5.000E-3	-1.000E-2	-5.000E-3
N° 4 (OFF)	---	-1.000E-2	-1.000E-2	-1.000E-2	-1.000E-2	0.000E+0	-1.000E-2	-1.000E-2	-5.000E-3	-1.000E-2
N° 5 (OFF)	---	-5.000E-3	-1.000E-2	-1.000E-2	-1.000E-2	0.000E+0	-1.000E-2	-1.000E-2	-1.500E-2	-1.000E-2
N° 6 (OFF)	---	-1.000E-2	-1.000E-2	-5.000E-3	-1.500E-2	-5.000E-3	-5.000E-3	-1.500E-2	-1.000E-2	-1.000E-2
Average (OFF)	---	-6.000E-3	-7.000E-3	-5.000E-3	-9.000E-3	-1.000E-3	-7.000E-3	-9.000E-3	-8.000E-3	-8.000E-3
s (OFF)	---	4.183E-3	4.472E-3	6.124E-3	4.183E-3	4.183E-3	2.739E-3	4.183E-3	5.701E-3	2.739E-3
Average+3s (OFF)	---	6.550E-3	6.416E-3	1.337E-2	3.550E-3	1.155E-2	1.216E-3	3.550E-3	9.103E-3	2.158E-4
Average-3s (OFF)	---	-1.855E-2	-2.042E-2	-2.337E-2	-2.155E-2	-1.355E-2	-1.522E-2	-2.155E-2	-2.510E-2	-1.622E-2

5. VOH

Ta = 25°C ; +Vs = +3.3V

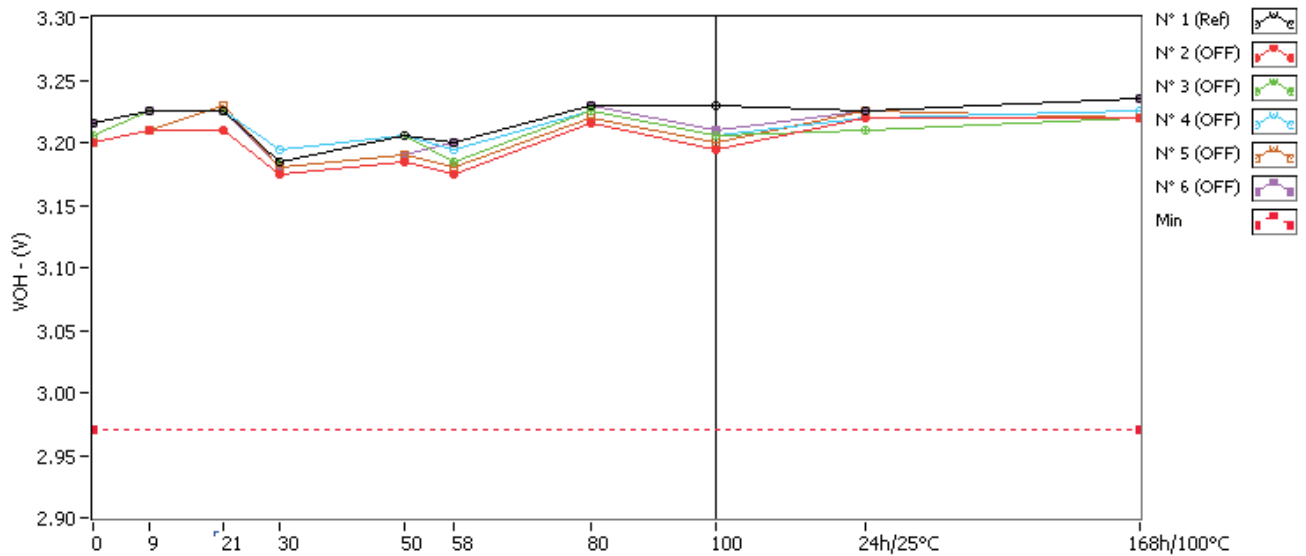

VOH . (V)

Min = 2.97

	0krad(Si)	9krad(Si)	21krad(Si)	30krad(Si)	50krad(Si)	58krad(Si)	80krad(Si)	100krad(Si)	24h/25°C	168h/100°C
N° 1 (Ref)	3.215	3.225	3.225	3.185	3.205	3.200	3.230	3.230	3.225	3.235
N° 2 (OFF)	3.200	3.210	3.210	3.175	3.185	3.175	3.215	3.195	3.220	3.220
N° 3 (OFF)	3.205	3.225	3.225	3.185	3.205	3.185	3.225	3.205	3.210	3.220
N° 4 (OFF)	3.215	3.225	3.225	3.195	3.205	3.195	3.225	3.205	3.220	3.225
N° 5 (OFF)	3.200	3.210	3.230	3.180	3.190	3.180	3.220	3.200	3.225	3.220
N° 6 (OFF)	3.215	3.225	3.225	3.180	3.190	3.200	3.230	3.210	3.225	3.235

Delta [VOH]

	0krad(Si)	9krad(Si)	21krad(Si)	30krad(Si)	50krad(Si)	58krad(Si)	80krad(Si)	100krad(Si)	24h/25°C	168h/100°C
N° 1 (Ref)	---	1.000E-2	1.000E-2	-3.000E-2	-1.000E-2	-1.500E-2	1.500E-2	1.500E-2	1.000E-2	2.000E-2
N° 2 (OFF)	---	1.000E-2	1.000E-2	-2.500E-2	-1.500E-2	-2.500E-2	1.500E-2	-5.000E-3	2.000E-2	2.000E-2
N° 3 (OFF)	---	2.000E-2	2.000E-2	-2.000E-2	0.000E+0	-2.000E-2	2.000E-2	0.000E+0	5.000E-3	1.500E-2
N° 4 (OFF)	---	1.000E-2	1.000E-2	-2.000E-2	-1.000E-2	-2.000E-2	1.000E-2	-1.000E-2	5.000E-3	1.000E-2
N° 5 (OFF)	---	1.000E-2	3.000E-2	-2.000E-2	-1.000E-2	-2.000E-2	2.000E-2	0.000E+0	2.500E-2	2.000E-2
N° 6 (OFF)	---	1.000E-2	1.000E-2	-3.500E-2	-2.500E-2	-1.500E-2	1.500E-2	-5.000E-3	1.000E-2	2.000E-2
Average (OFF)	---	1.200E-2	1.600E-2	-2.400E-2	-1.200E-2	-2.000E-2	1.600E-2	-4.000E-3	1.300E-2	1.700E-2
s (OFF)	---	4.472E-3	8.944E-3	6.519E-3	9.083E-3	3.536E-3	4.183E-3	4.183E-3	9.083E-3	4.472E-3
Average+3s (OFF)	---	2.542E-2	4.283E-2	-4.442E-3	1.525E-2	-9.393E-3	2.855E-2	8.550E-3	4.025E-2	3.042E-2
Average-3s (OFF)	---	-1.416E-3	-1.083E-2	-4.356E-2	-3.925E-2	-3.061E-2	3.450E-3	-1.655E-2	-1.425E-2	3.584E-3

6. Tr

Ta = 25°C ; +Vs = +3.3V ; 10% to 90% level

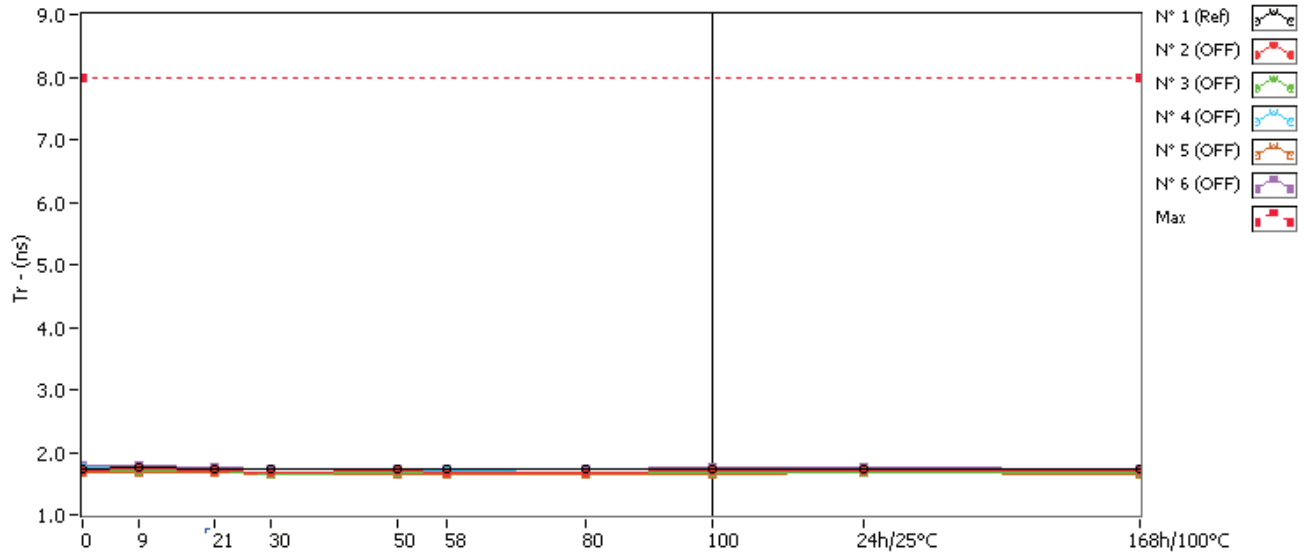

Tr . (ns) Max = 8.0

	0krad(Si)	9krad(Si)	21krad(Si)	30krad(Si)	50krad(Si)	58krad(Si)	80krad(Si)	100krad(Si)	24h/25°C	168h/100°C
N° 1 (Ref)	1.731	1.756	1.727	1.725	1.738	1.722	1.719	1.719	1.734	1.729
N° 2 (OFF)	1.712	1.727	1.700	1.688	1.709	1.685	1.689	1.694	1.693	1.697
N° 3 (OFF)	1.699	1.718	1.692	1.661	1.684	1.663	1.671	1.670	1.679	1.666
N° 4 (OFF)	1.748	1.774	1.743	1.732	1.739	1.713	1.719	1.725	1.721	1.721
N° 5 (OFF)	1.666	1.682	1.684	1.643	1.653	1.646	1.647	1.647	1.673	1.655
N° 6 (OFF)	1.776	1.794	1.762	1.725	1.731	1.727	1.744	1.749	1.753	1.720

Delta [Tr]

	0krad(Si)	9krad(Si)	21krad(Si)	30krad(Si)	50krad(Si)	58krad(Si)	80krad(Si)	100krad(Si)	24h/25°C	168h/100°C
N° 1 (Ref)	---	2.520E-2	-4.000E-3	-6.200E-3	7.600E-3	-9.100E-3	-1.150E-2	-1.150E-2	3.400E-3	-1.500E-3
N° 2 (OFF)	---	1.510E-2	-1.170E-2	-2.370E-2	-2.900E-3	-2.700E-2	-2.350E-2	-1.800E-2	-1.900E-2	-1.510E-2
N° 3 (OFF)	---	1.880E-2	-6.800E-3	-3.830E-2	-1.520E-2	-3.600E-2	-2.780E-2	-2.930E-2	-2.050E-2	-3.360E-2
N° 4 (OFF)	---	2.550E-2	-5.100E-3	-1.580E-2	-9.300E-3	-3.540E-2	-2.860E-2	-2.330E-2	-2.690E-2	-2.710E-2
N° 5 (OFF)	---	1.620E-2	1.830E-2	-2.300E-2	-1.320E-2	-1.990E-2	-1.880E-2	-1.870E-2	6.900E-3	-1.050E-2
N° 6 (OFF)	---	1.740E-2	-1.460E-2	-5.120E-2	-4.500E-2	-4.930E-2	-3.260E-2	-2.710E-2	-2.350E-2	-5.590E-2
Average (OFF)	---	1.860E-2	-3.980E-3	-3.040E-2	-1.712E-2	-3.352E-2	-2.626E-2	-2.328E-2	-1.660E-2	-2.844E-2
s (OFF)	---	4.096E-3	1.302E-2	1.421E-2	1.628E-2	1.103E-2	5.275E-3	4.992E-3	1.348E-2	1.790E-2
Average+3s (OFF)	---	3.089E-2	3.508E-2	1.223E-2	3.171E-2	-4.278E-4	-1.043E-2	-8.303E-3	2.384E-2	2.527E-2
Average-3s (OFF)	---	6.313E-3	-4.304E-2	-7.303E-2	-6.595E-2	-6.661E-2	-4.209E-2	-3.826E-2	-5.704E-2	-8.215E-2

7. Tf

Ta = 25°C ; +Vs = +3.3V ; 90% to 10% level

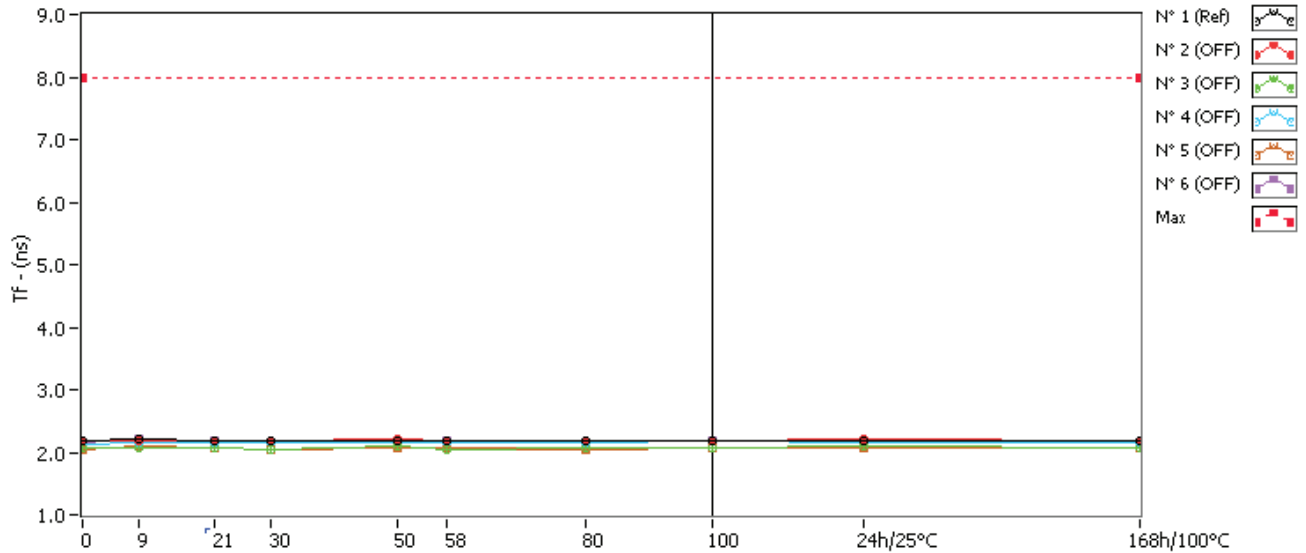

Tf. (ns) Max = 8.0

	0krad(Si)	9krad(Si)	21krad(Si)	30krad(Si)	50krad(Si)	58krad(Si)	80krad(Si)	100krad(Si)	24h/25°C	168h/100°C
N° 1 (Ref)	2.191	2.204	2.183	2.183	2.194	2.174	2.182	2.182	2.184	2.176
N° 2 (OFF)	2.172	2.191	2.189	2.189	2.216	2.180	2.174	2.187	2.199	2.191
N° 3 (OFF)	2.059	2.083	2.066	2.047	2.085	2.056	2.060	2.083	2.085	2.071
N° 4 (OFF)	2.135	2.157	2.144	2.143	2.145	2.149	2.142	2.174	2.158	2.147
N° 5 (OFF)	2.056	2.086	2.057	2.052	2.073	2.066	2.041	2.074	2.067	2.073
N° 6 (OFF)	2.161	2.202	2.172	2.156	2.194	2.177	2.167	2.197	2.192	2.163

Delta [Tf]

	0krad(Si)	9krad(Si)	21krad(Si)	30krad(Si)	50krad(Si)	58krad(Si)	80krad(Si)	100krad(Si)	24h/25°C	168h/100°C
N° 1 (Ref)	---	1.260E-2	-8.100E-3	-8.100E-3	2.500E-3	-1.680E-2	-9.200E-3	-9.200E-3	-6.900E-3	-1.520E-2
N° 2 (OFF)	---	1.870E-2	1.710E-2	1.710E-2	4.450E-2	7.800E-3	2.200E-3	1.470E-2	2.690E-2	1.920E-2
N° 3 (OFF)	---	2.380E-2	6.600E-3	-1.230E-2	2.540E-2	-3.200E-3	8.000E-4	2.430E-2	2.580E-2	1.230E-2
N° 4 (OFF)	---	2.220E-2	9.100E-3	8.600E-3	1.070E-2	1.470E-2	7.700E-3	3.960E-2	2.310E-2	1.240E-2
N° 5 (OFF)	---	2.970E-2	1.600E-3	-3.600E-3	1.700E-2	9.800E-3	-1.470E-2	1.810E-2	1.090E-2	1.710E-2
N° 6 (OFF)	---	4.150E-2	1.140E-2	-4.100E-3	3.300E-2	1.610E-2	6.100E-3	3.620E-2	3.100E-2	2.500E-3
Average (OFF)	---	2.718E-2	9.160E-3	1.140E-3	2.612E-2	9.040E-3	4.200E-4	2.658E-2	2.354E-2	1.270E-2
s (OFF)	---	8.938E-3	5.740E-3	1.163E-2	1.329E-2	7.645E-3	8.905E-3	1.096E-2	7.616E-3	6.440E-3
Average+3s (OFF)	---	5.399E-2	2.638E-2	3.603E-2	6.599E-2	3.198E-2	2.713E-2	5.945E-2	4.639E-2	3.202E-2
Average-3s (OFF)	---	3.661E-4	-8.059E-3	-3.375E-2	-1.375E-2	-1.390E-2	-2.629E-2	-6.294E-3	6.921E-4	-6.620E-3

8. Dc

Ta = 25°C ; +Vs = +3.3V ; at 50% level

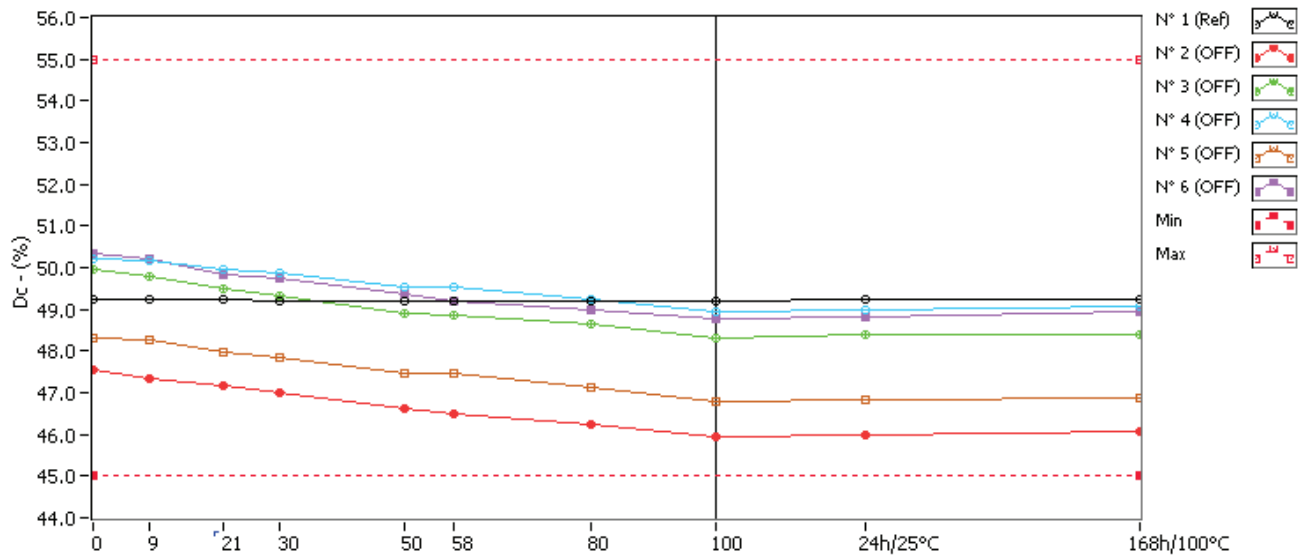

Dc . (%) Min = 45.0 Max = 55.0

	0krad(Si)	9krad(Si)	21krad(Si)	30krad(Si)	50krad(Si)	58krad(Si)	80krad(Si)	100krad(Si)	24h/25°C	168h/100°C
N° 1 (Ref)	49.240	49.245	49.238	49.208	49.211	49.211	49.216	49.216	49.234	49.232
N° 2 (OFF)	47.568	47.335	47.180	46.983	46.603	46.480	46.224	45.931	45.979	46.058
N° 3 (OFF)	49.972	49.803	49.504	49.331	48.892	48.849	48.645	48.323	48.399	48.404
N° 4 (OFF)	50.202	50.154	49.967	49.876	49.515	49.550	49.239	48.946	48.968	49.061
N° 5 (OFF)	48.289	48.253	47.960	47.828	47.477	47.461	47.109	46.773	46.811	46.886
N° 6 (OFF)	50.317	50.200	49.829	49.736	49.348	49.190	48.977	48.769	48.796	48.928

Delta [Dc]

	0krad(Si)	9krad(Si)	21krad(Si)	30krad(Si)	50krad(Si)	58krad(Si)	80krad(Si)	100krad(Si)	24h/25°C	168h/100°C
N° 1 (Ref)	---	5.500E-3	-1.900E-3	-3.210E-2	-2.890E-2	-2.870E-2	-2.410E-2	-2.410E-2	-5.300E-3	-7.800E-3
N° 2 (OFF)	---	-2.328E-1	-3.876E-1	-5.846E-1	-9.646E-1	-1.088E+0	-1.344E+0	-1.636E+0	-1.588E+0	-1.510E+0
N° 3 (OFF)	---	-1.691E-1	-4.683E-1	-6.418E-1	-1.080E+0	-1.123E+0	-1.327E+0	-1.649E+0	-1.573E+0	-1.569E+0
N° 4 (OFF)	---	-4.830E-2	-2.352E-1	-3.257E-1	-6.875E-1	-6.524E-1	-9.635E-1	-1.256E+0	-1.234E+0	-1.141E+0
N° 5 (OFF)	---	-3.640E-2	-3.292E-1	-4.612E-1	-8.124E-1	-8.278E-1	-1.180E+0	-1.516E+0	-1.478E+0	-1.403E+0
N° 6 (OFF)	---	-1.176E-1	-4.885E-1	-5.810E-1	-9.694E-1	-1.128E+0	-1.340E+0	-1.548E+0	-1.521E+0	-1.389E+0
Average (OFF)	---	-1.208E-1	-3.818E-1	-5.189E-1	-9.028E-1	-9.637E-1	-1.231E+0	-1.521E+0	-1.479E+0	-1.402E+0
s (OFF)	---	8.256E-2	1.039E-1	1.264E-1	1.534E-1	2.139E-1	1.643E-1	1.588E-1	1.437E-1	1.640E-1
Average+3s (OFF)	---	1.268E-1	-7.014E-2	-1.396E-1	-4.424E-1	-3.221E-1	-7.381E-1	-1.045E+0	-1.048E+0	-9.105E-1
Average-3s (OFF)	---	-3.685E-1	-6.934E-1	-8.981E-1	-1.363E+0	-1.605E+0	-1.724E+0	-1.997E+0	-1.910E+0	-1.894E+0

9. VIH

Ta = 25°C ; +Vs = +3.3V

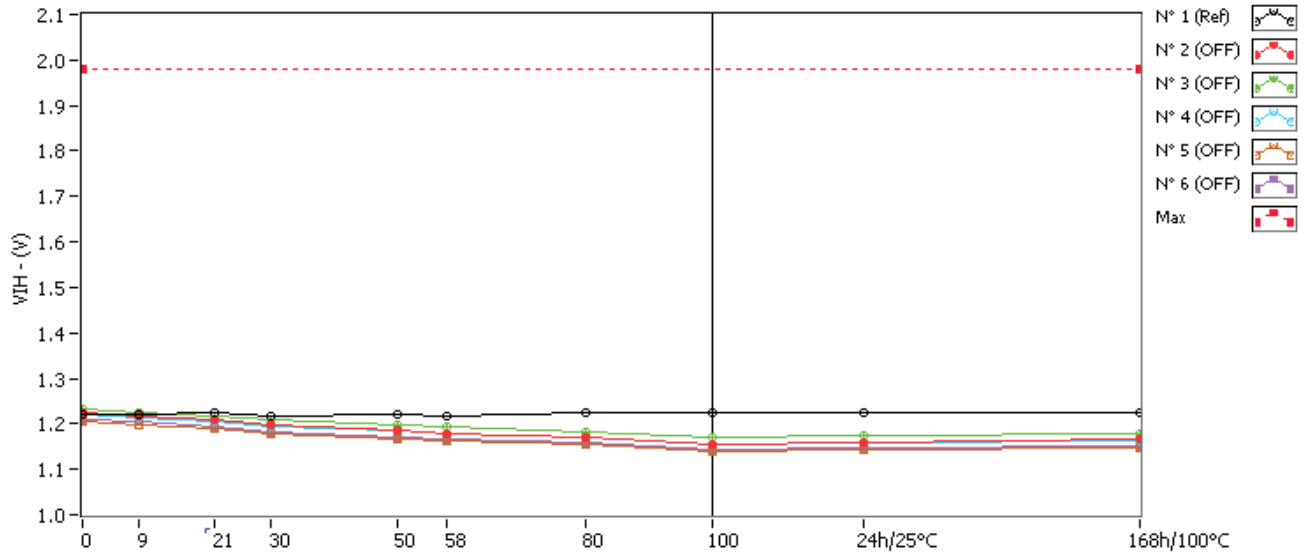

VIH . (V)

Max = 1.98

	0krad(Si)	9krad(Si)	21krad(Si)	30krad(Si)	50krad(Si)	58krad(Si)	80krad(Si)	100krad(Si)	24h/25°C	168h/100°C
N° 1 (Ref)	1.221	1.222	1.223	1.218	1.219	1.218	1.223	1.223	1.224	1.226
N° 2 (OFF)	1.224	1.218	1.209	1.199	1.186	1.178	1.169	1.154	1.158	1.165
N° 3 (OFF)	1.232	1.226	1.219	1.208	1.197	1.192	1.183	1.169	1.173	1.179
N° 4 (OFF)	1.219	1.213	1.205	1.194	1.184	1.178	1.169	1.155	1.159	1.165
N° 5 (OFF)	1.205	1.199	1.191	1.179	1.168	1.161	1.153	1.139	1.143	1.149
N° 6 (OFF)	1.210	1.204	1.194	1.183	1.171	1.165	1.158	1.142	1.146	1.151

Delta [VIH]

	0krad(Si)	9krad(Si)	21krad(Si)	30krad(Si)	50krad(Si)	58krad(Si)	80krad(Si)	100krad(Si)	24h/25°C	168h/100°C
N° 1 (Ref)	---	9.000E-4	1.900E-3	-3.700E-3	-2.000E-3	-3.100E-3	1.600E-3	1.600E-3	2.500E-3	4.300E-3
N° 2 (OFF)	---	-6.600E-3	-1.470E-2	-2.550E-2	-3.850E-2	-4.600E-2	-5.480E-2	-7.010E-2	-6.580E-2	-5.940E-2
N° 3 (OFF)	---	-6.000E-3	-1.380E-2	-2.430E-2	-3.540E-2	-4.070E-2	-4.950E-2	-6.330E-2	-5.930E-2	-5.350E-2
N° 4 (OFF)	---	-6.400E-3	-1.410E-2	-2.490E-2	-3.490E-2	-4.170E-2	-5.060E-2	-6.470E-2	-6.050E-2	-5.470E-2
N° 5 (OFF)	---	-5.800E-3	-1.420E-2	-2.580E-2	-3.710E-2	-4.360E-2	-5.140E-2	-6.580E-2	-6.170E-2	-5.580E-2
N° 6 (OFF)	---	-6.000E-3	-1.590E-2	-2.730E-2	-3.890E-2	-4.530E-2	-5.270E-2	-6.840E-2	-6.450E-2	-5.900E-2
Average (OFF)	---	-6.160E-3	-1.454E-2	-2.556E-2	-3.696E-2	-4.346E-2	-5.180E-2	-6.646E-2	-6.236E-2	-5.648E-2
s (OFF)	---	3.286E-4	8.264E-4	1.130E-3	1.791E-3	2.268E-3	2.043E-3	2.763E-3	2.724E-3	2.617E-3
Average+3s (OFF)	---	-5.174E-3	-1.206E-2	-2.217E-2	-3.159E-2	-3.666E-2	-4.567E-2	-5.817E-2	-5.419E-2	-4.863E-2
Average-3s (OFF)	---	-7.146E-3	-1.702E-2	-2.895E-2	-4.233E-2	-5.026E-2	-5.793E-2	-7.475E-2	-7.053E-2	-6.433E-2

10. VIL

Ta = 25°C ; +Vs = +3.3V

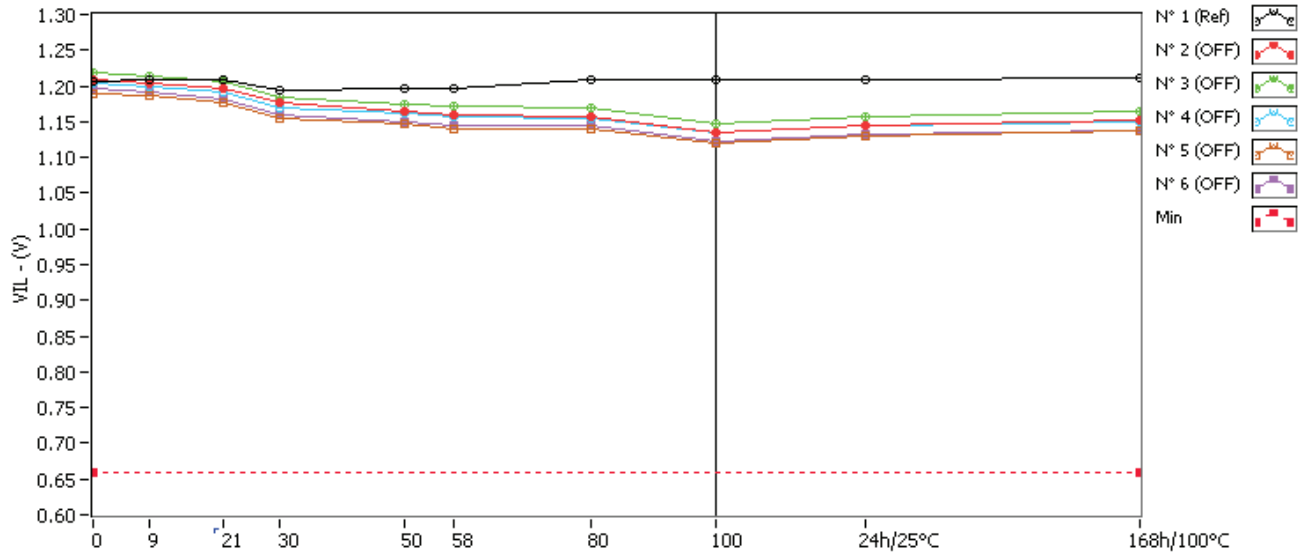

VIL . (V) Min = 0.66

	0krad(Si)	9krad(Si)	21krad(Si)	30krad(Si)	50krad(Si)	58krad(Si)	80krad(Si)	100krad(Si)	24h/25°C	168h/100°C
N° 1 (Ref)	1.206	1.209	1.210	1.193	1.197	1.197	1.208	1.208	1.209	1.211
N° 2 (OFF)	1.210	1.205	1.197	1.176	1.165	1.158	1.156	1.135	1.144	1.151
N° 3 (OFF)	1.218	1.214	1.206	1.184	1.175	1.171	1.169	1.148	1.158	1.165
N° 4 (OFF)	1.204	1.200	1.192	1.170	1.162	1.157	1.155	1.134	1.144	1.151
N° 5 (OFF)	1.190	1.186	1.178	1.155	1.147	1.141	1.140	1.119	1.129	1.136
N° 6 (OFF)	1.196	1.191	1.181	1.159	1.150	1.145	1.144	1.122	1.132	1.138

Delta [VIL]

	0krad(Si)	9krad(Si)	21krad(Si)	30krad(Si)	50krad(Si)	58krad(Si)	80krad(Si)	100krad(Si)	24h/25°C	168h/100°C
N° 1 (Ref)	---	2.300E-3	3.400E-3	-1.340E-2	-9.600E-3	-9.600E-3	2.100E-3	2.100E-3	2.300E-3	4.700E-3
N° 2 (OFF)	---	-4.900E-3	-1.290E-2	-3.410E-2	-4.510E-2	-5.140E-2	-5.360E-2	-7.500E-2	-6.540E-2	-5.820E-2
N° 3 (OFF)	---	-4.000E-3	-1.190E-2	-3.370E-2	-4.240E-2	-4.690E-2	-4.840E-2	-6.930E-2	-5.950E-2	-5.250E-2
N° 4 (OFF)	---	-4.700E-3	-1.240E-2	-3.400E-2	-4.200E-2	-4.780E-2	-4.960E-2	-7.060E-2	-6.000E-2	-5.370E-2
N° 5 (OFF)	---	-4.300E-3	-1.270E-2	-3.480E-2	-4.340E-2	-4.950E-2	-5.020E-2	-7.140E-2	-6.090E-2	-5.390E-2
N° 6 (OFF)	---	-4.200E-3	-1.400E-2	-3.620E-2	-4.540E-2	-5.090E-2	-5.110E-2	-7.390E-2	-6.380E-2	-5.730E-2
Average (OFF)	---	-4.420E-3	-1.278E-2	-3.456E-2	-4.366E-2	-4.930E-2	-5.058E-2	-7.204E-2	-6.192E-2	-5.512E-2
s (OFF)	---	3.701E-4	7.791E-4	1.001E-3	1.542E-3	1.938E-3	1.952E-3	2.356E-3	2.561E-3	2.480E-3
Average+3s (OFF)	---	-3.310E-3	-1.044E-2	-3.156E-2	-3.903E-2	-4.349E-2	-4.472E-2	-6.497E-2	-5.424E-2	-4.768E-2
Average-3s (OFF)	---	-5.530E-3	-1.512E-2	-3.756E-2	-4.829E-2	-5.511E-2	-5.644E-2	-7.911E-2	-6.960E-2	-6.256E-2



**TOTAL IONIZING DOSE
TEST REPORT**

40MHz-CFPT9006

Ref: TRAD/TE/40MHz-CFPT9006/XXX1/ESA/BR/1207
Date: December 10th, 2012

Rev: 1

15. APPENDIX D : OUTPUT VISUALIZATION

Contents :

1 PART1	D-2
2 PART2	D-3
3 PART3	D-4
4 PART4	D-5
5 PART5	D-6
6 PART6	D-7
7 PART7	D-8
8 PART8	D-9
9 PART9	D-10
10 PART10	D-11
11 PART11	D-12
12 PART12	D-13
13 PART13	D-14
14 PART14	D-15
15 PART15	D-16
16 PART16	D-17

1. PART1

Ta = 25°C ; +Vs = +3.3V

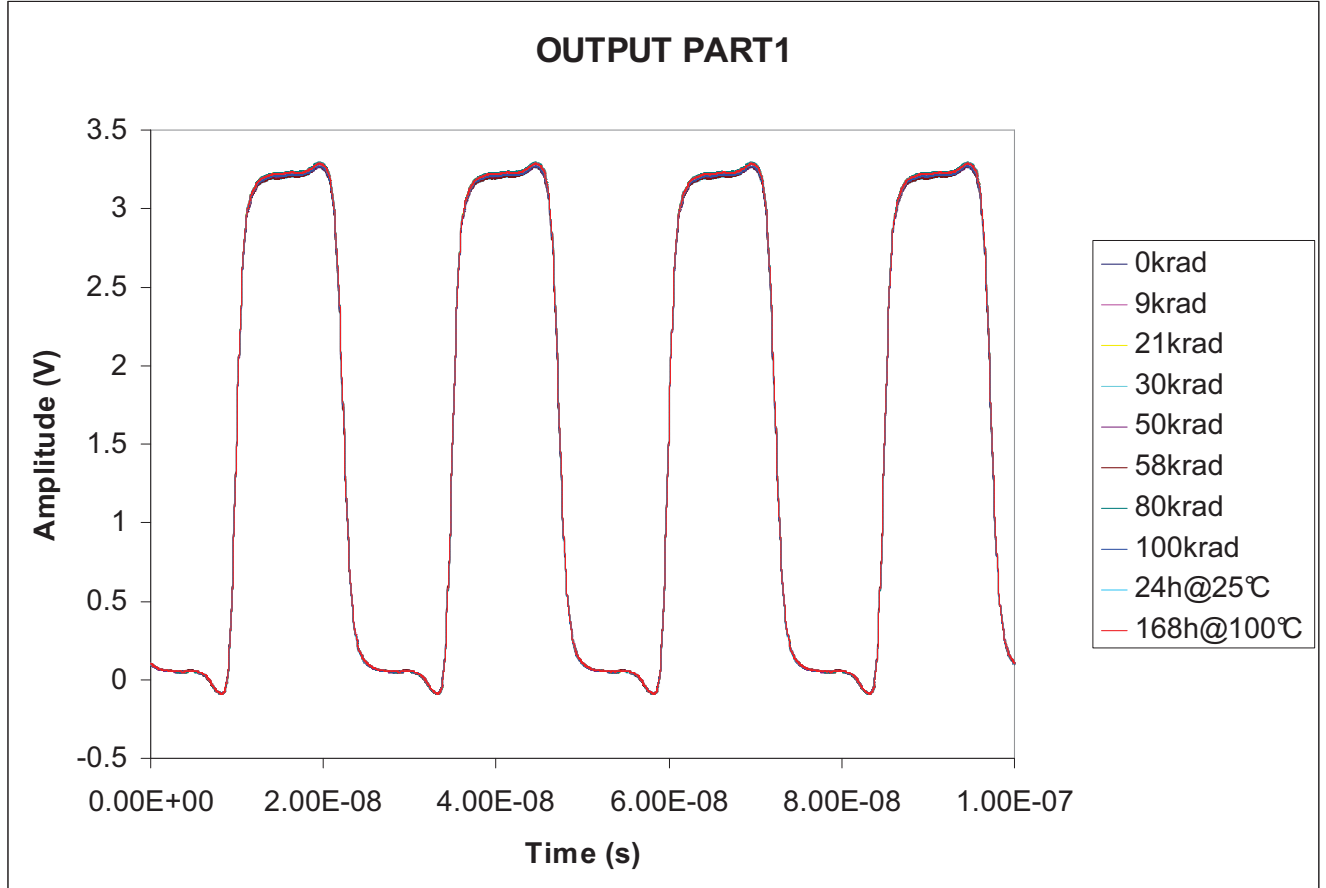

2. PART2

Ta = 25°C ; +Vs = +3.3V

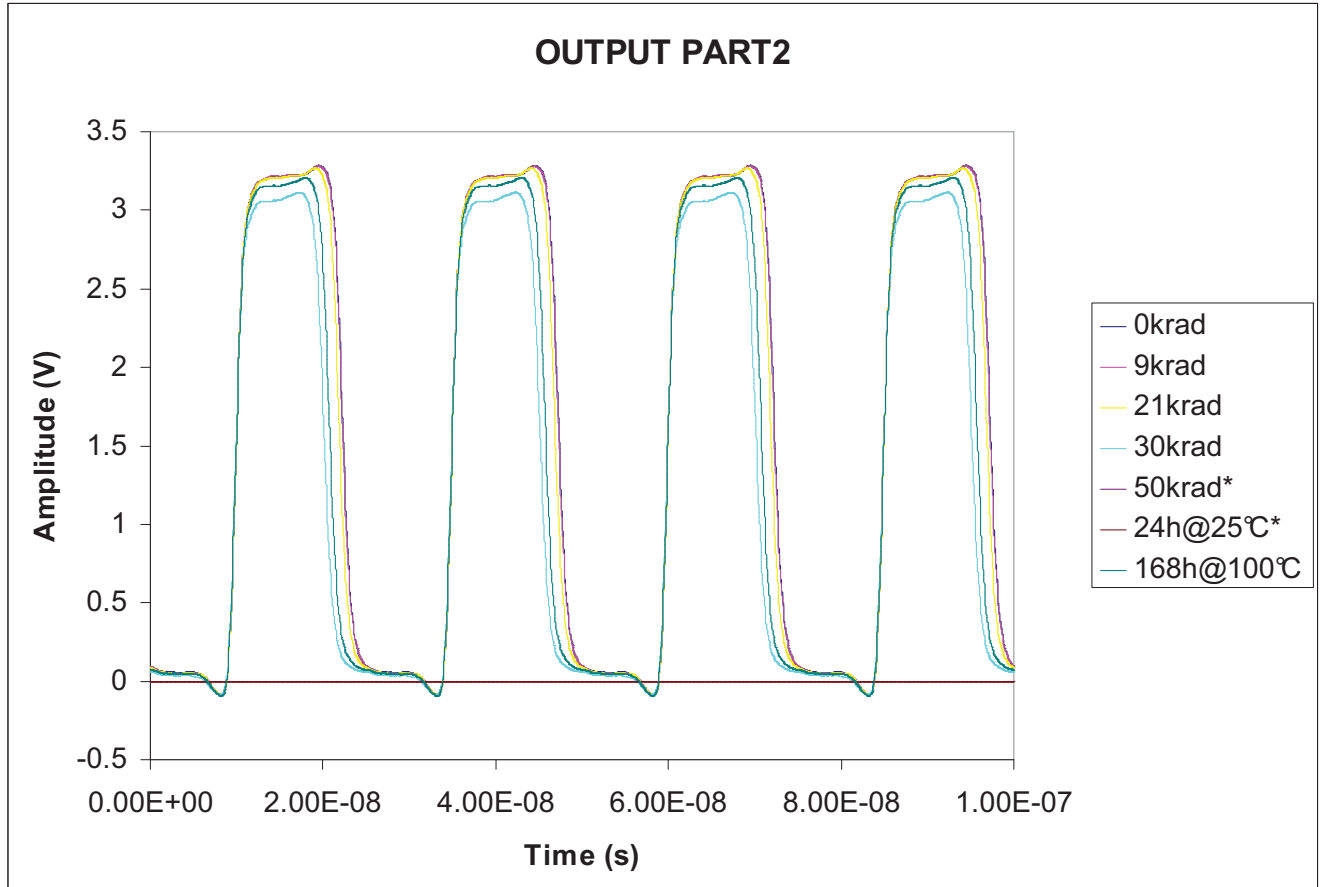

* The 50 krad and 24h@25°C curves are superimposed at 0V amplitude.

3. PART3

Ta = 25°C ; +Vs = +3.3V

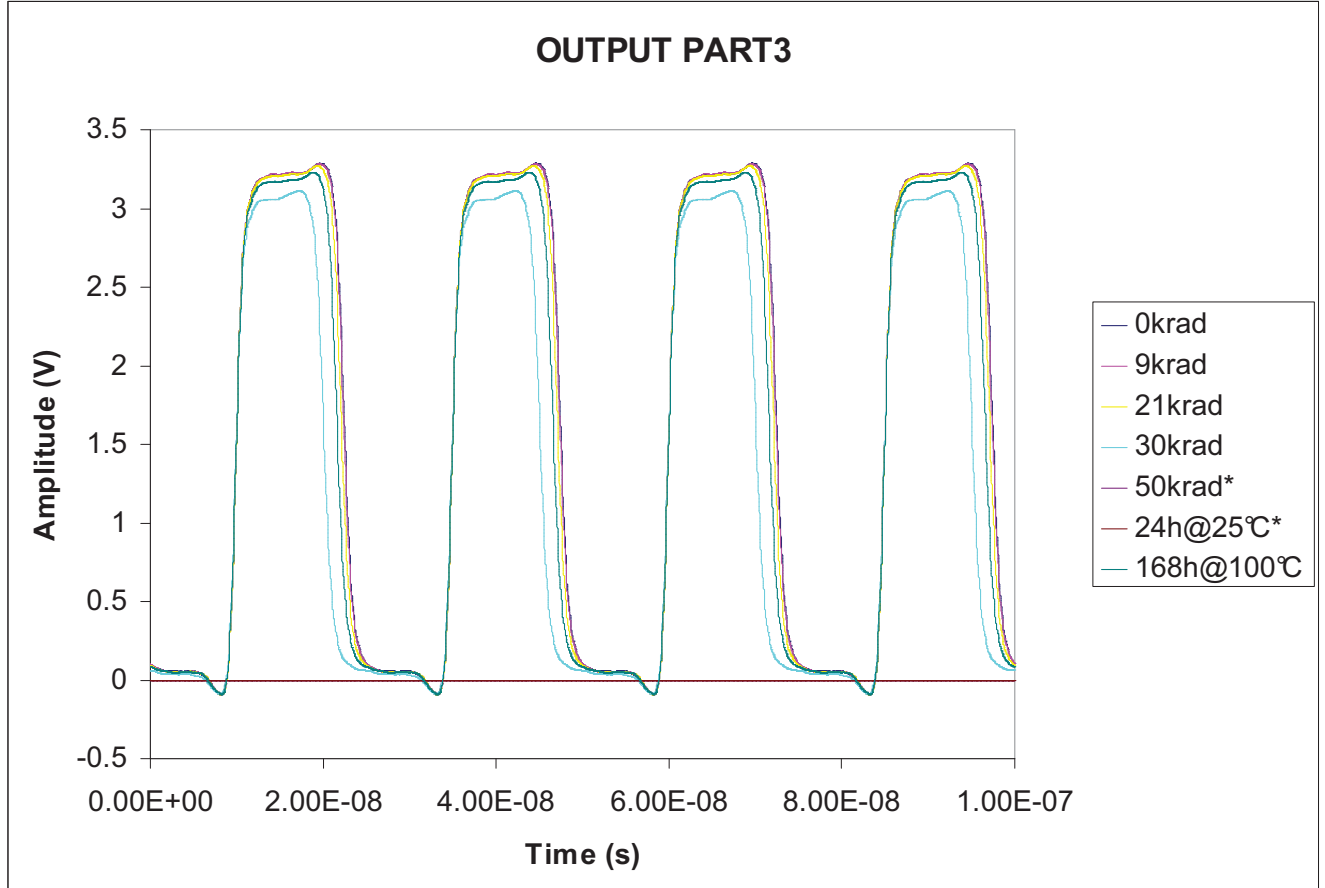

* The 50 krad and 24h@25°C curves are superimposed at 0V amplitude.

4. PART4

Ta = 25°C ; +Vs = +3.3V

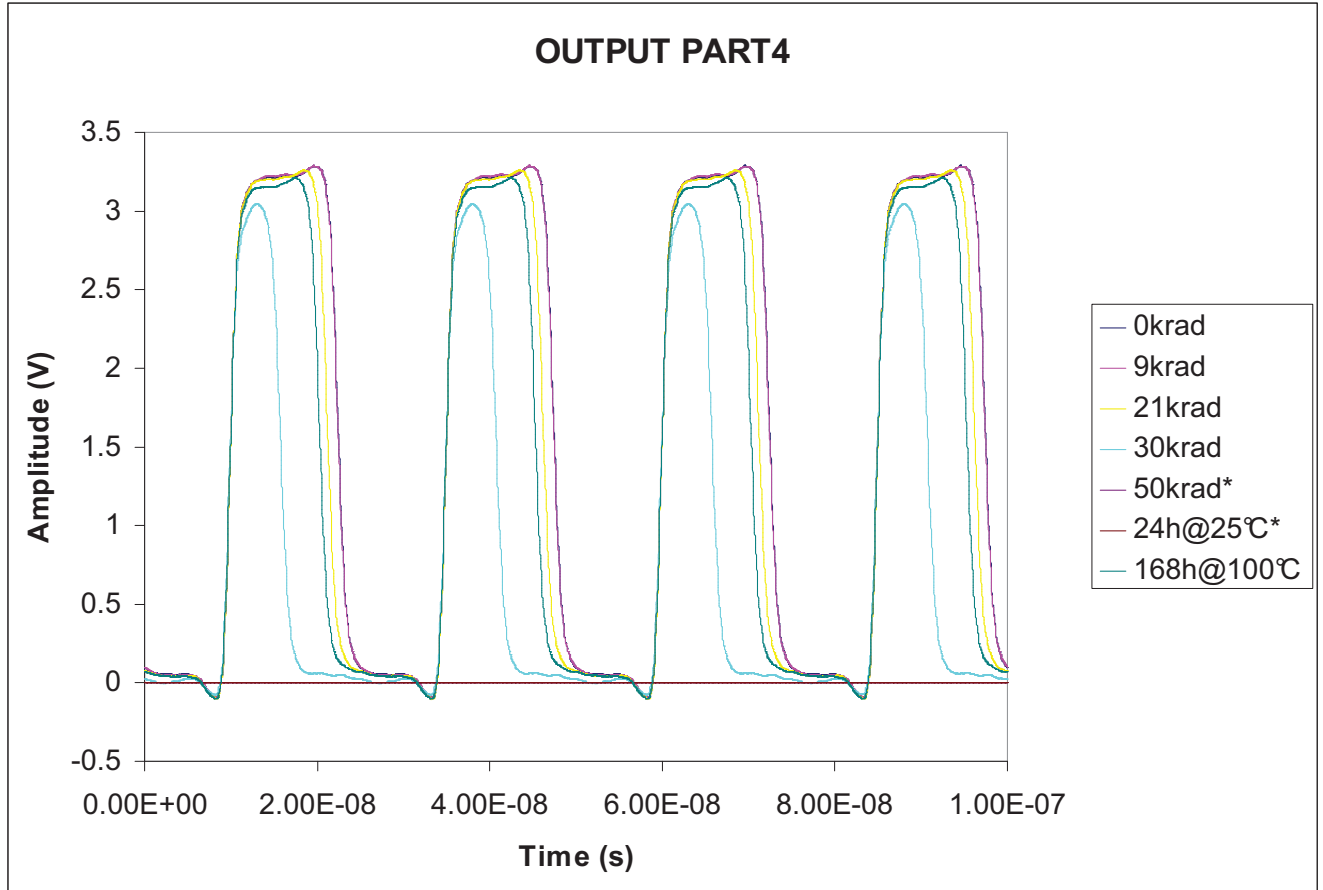

* The 50 krad and 24h@25°C curves are superimposed at 0V amplitude.

5. PART5

Ta = 25°C ; +Vs = +3.3V

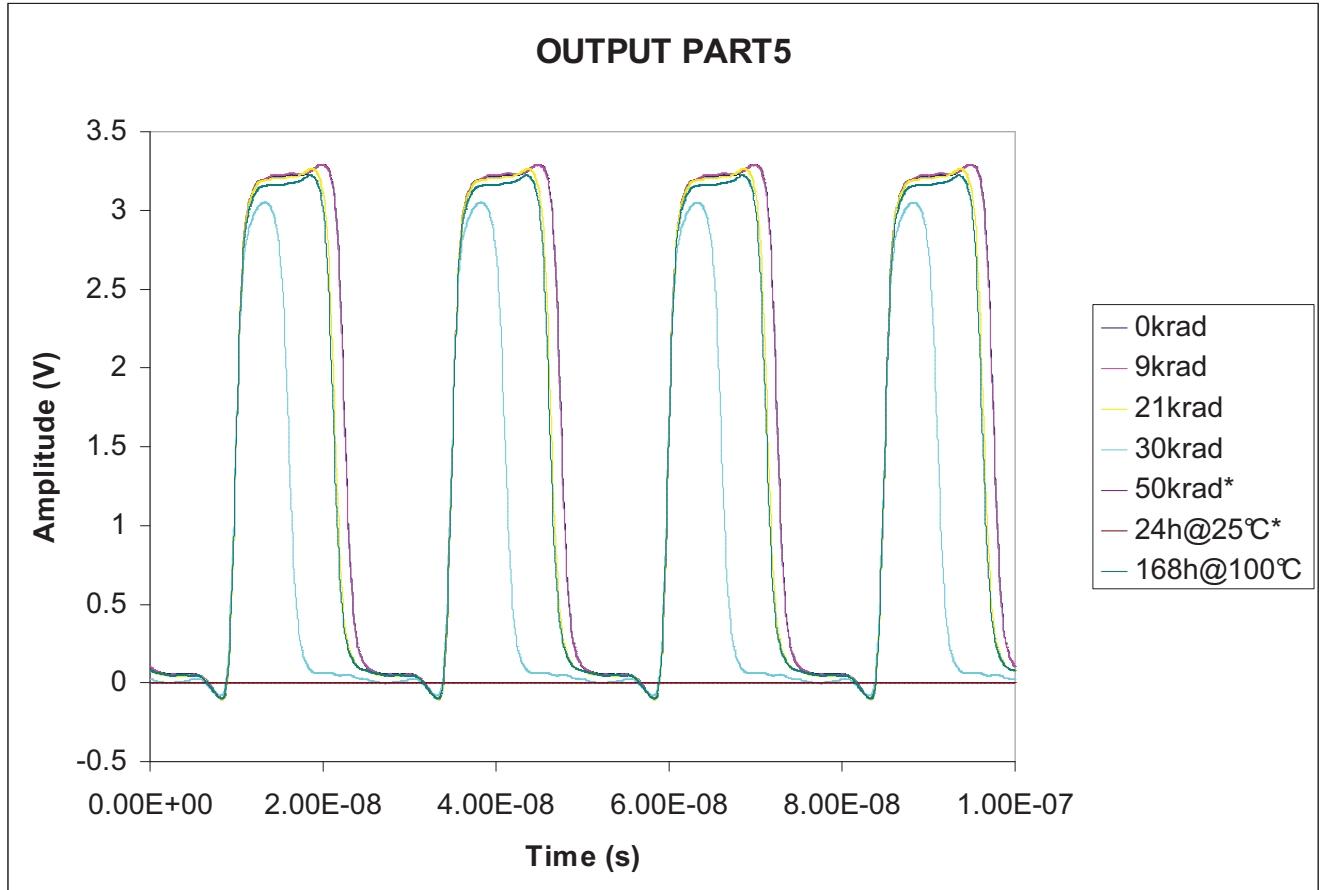

* The 50 krad and 24h@25°C curves are superimposed at 0V amplitude.

6. PART6

Ta = 25°C ; +Vs = +3.3V

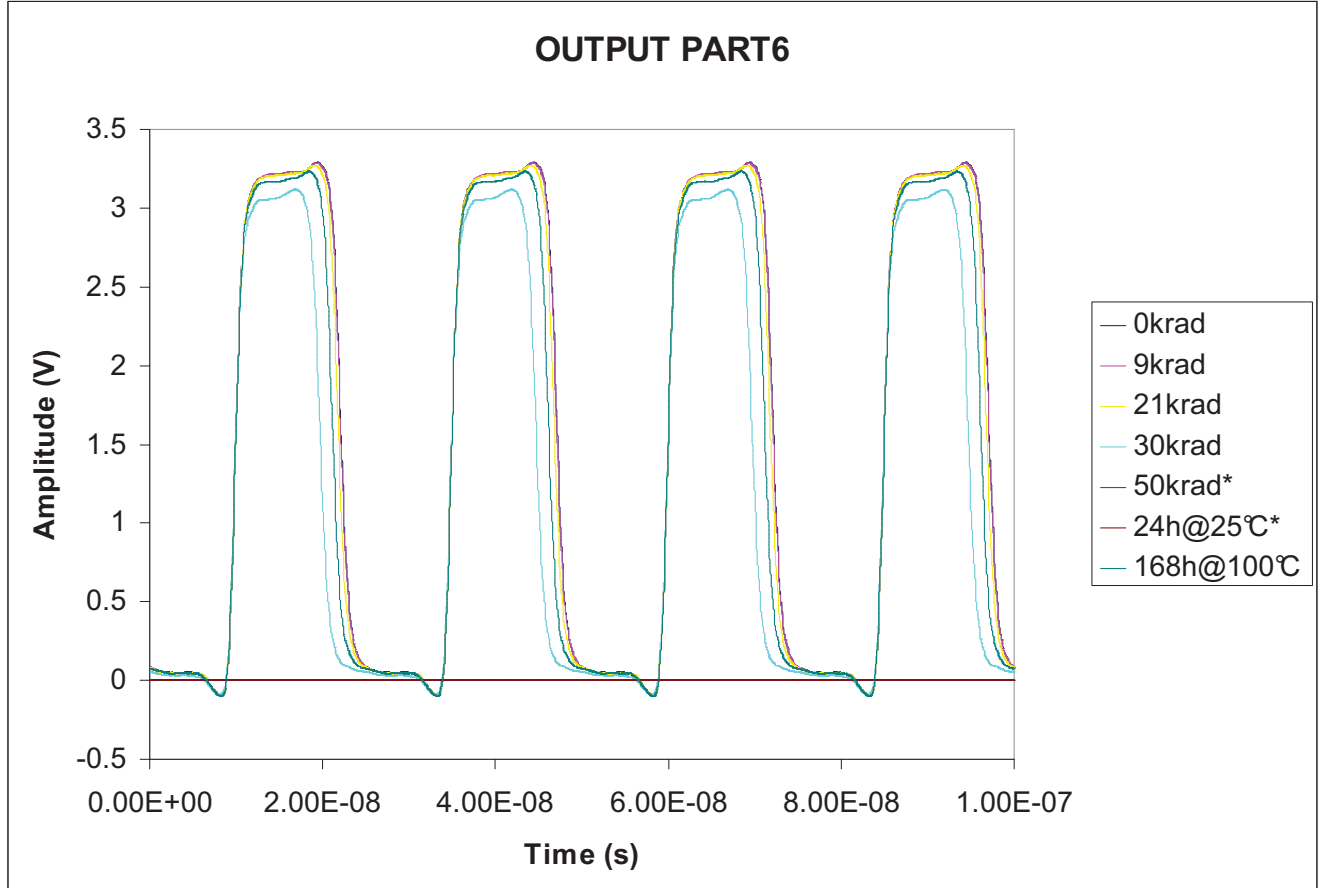

* The 50 krad and 24h@25°C curves are superimposed at 0V amplitude.

7. PART7

Ta = 25°C ; +Vs = +3.3V

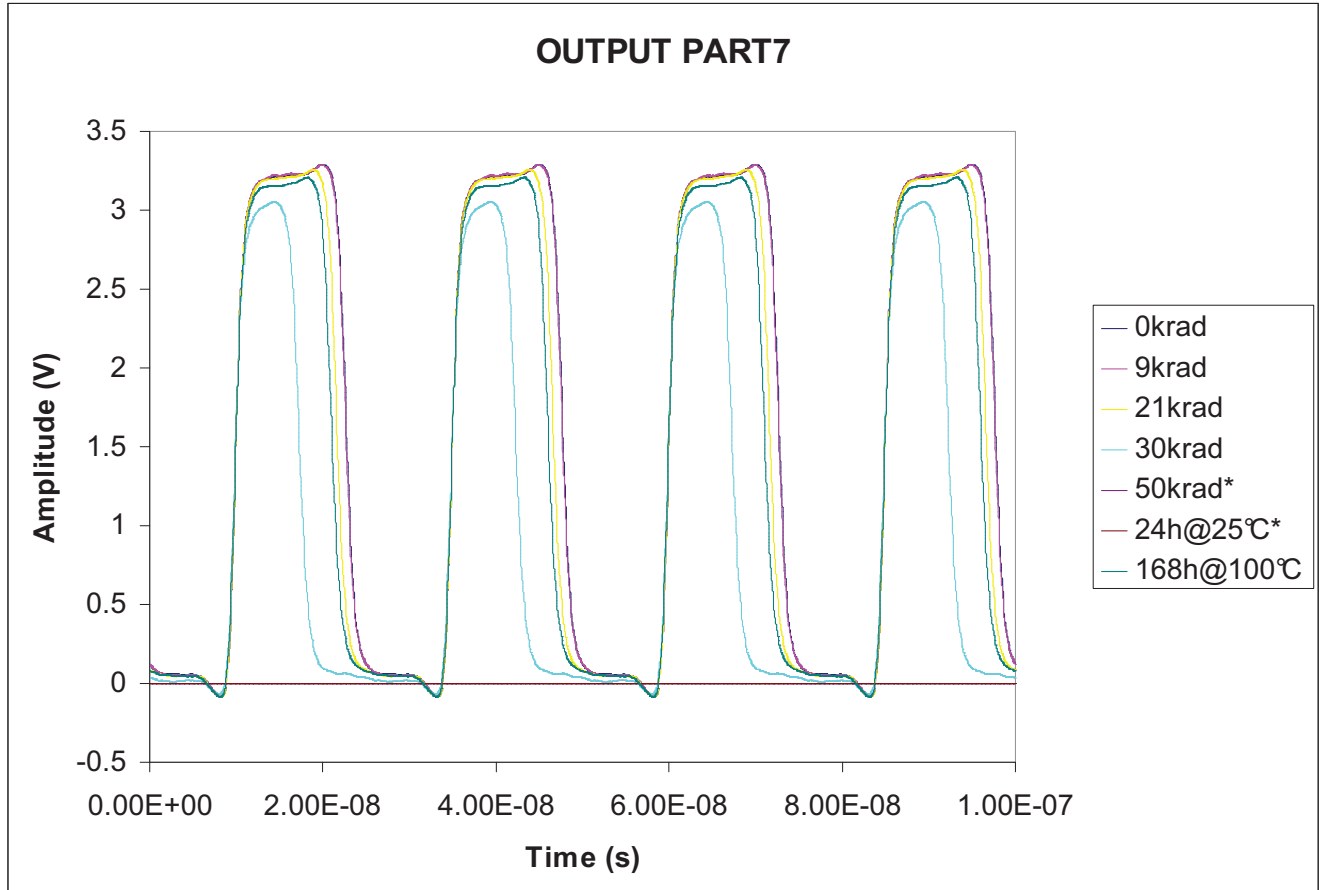

* The 50 krad and 24h@25°C curves are superimposed at 0V amplitude.

8. PART8

Ta = 25°C ; +Vs = +3.3V

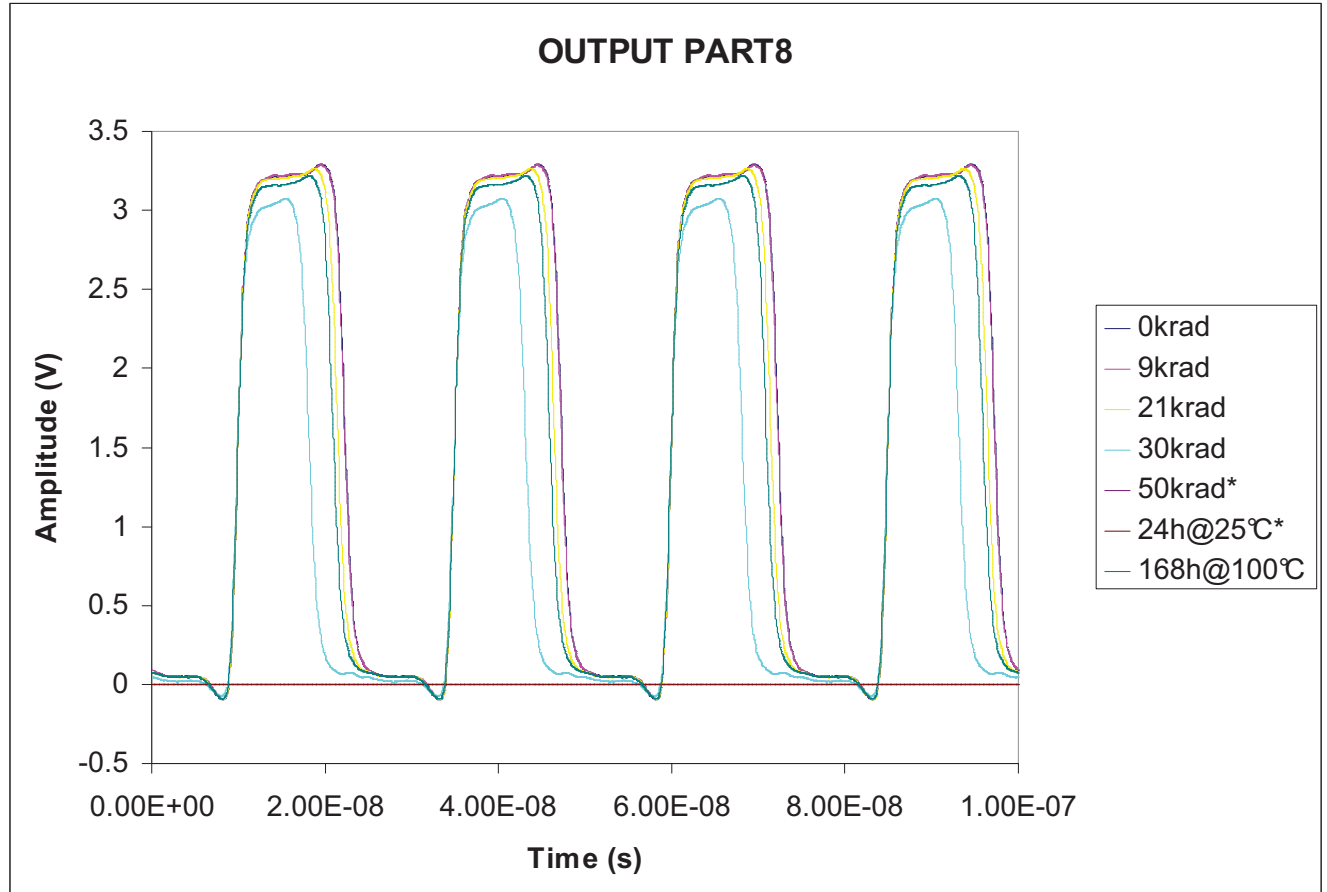

* The 50 krad and 24h@25°C curves are superimposed at 0V amplitude.

9. PART9

Ta = 25°C ; +Vs = +3.3V

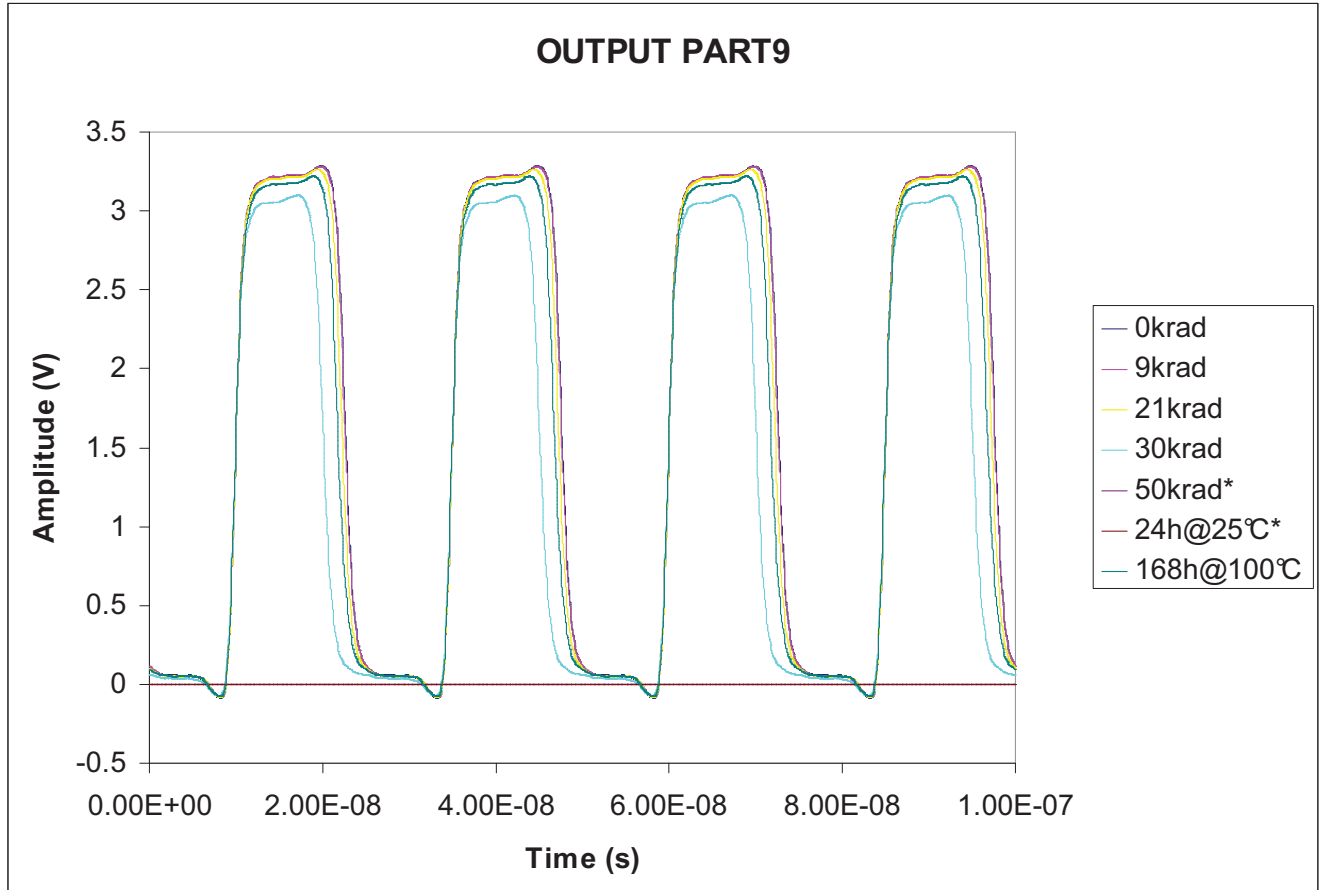

* The 50 krad and 24h@25°C curves are superimposed at 0V amplitude.

10. PART10

Ta = 25°C ; +Vs = +3.3V

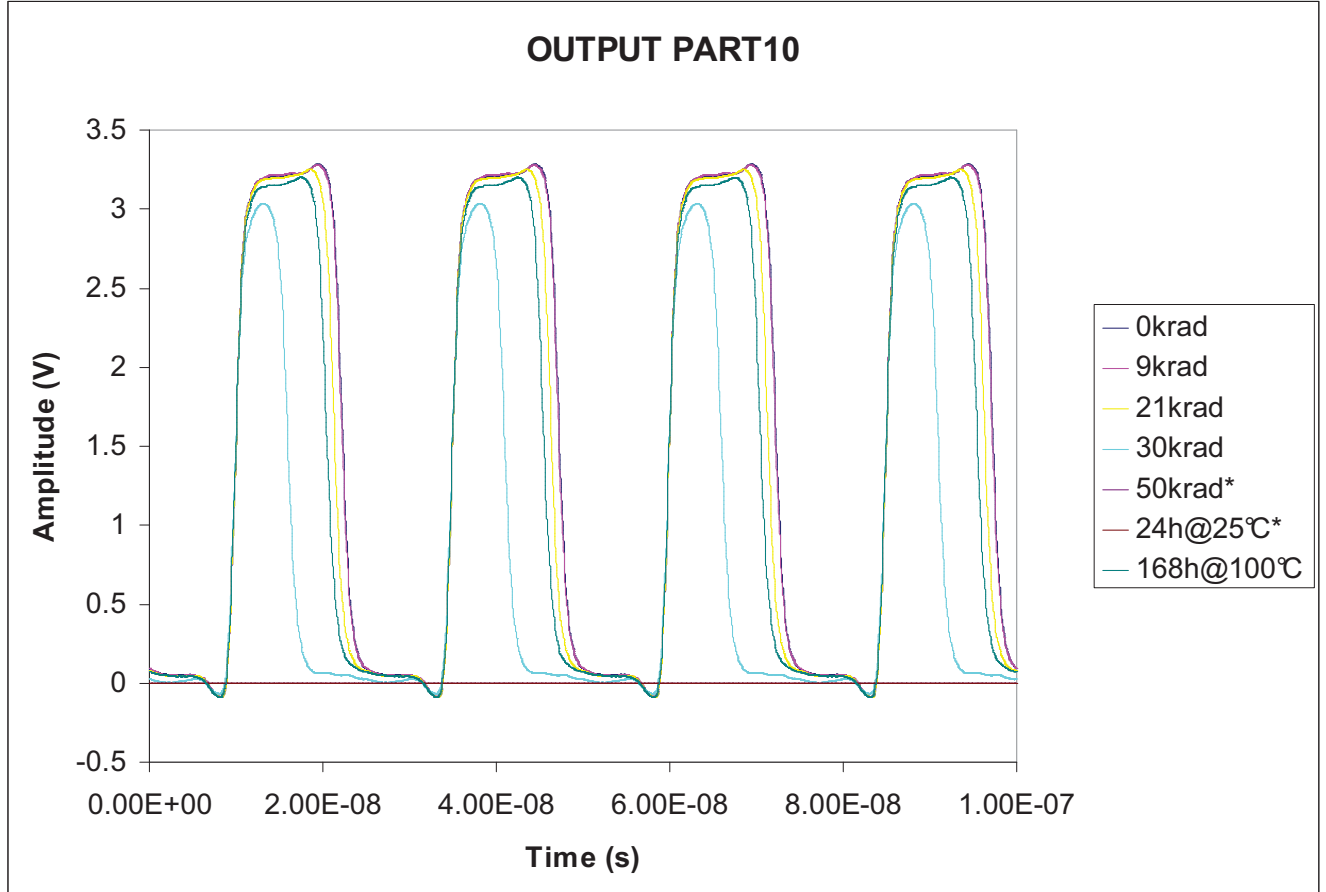

* The 50 krad and 24h@25°C curves are superimposed at 0V amplitude.

11. PART11

Ta = 25°C ; +Vs = +3.3V

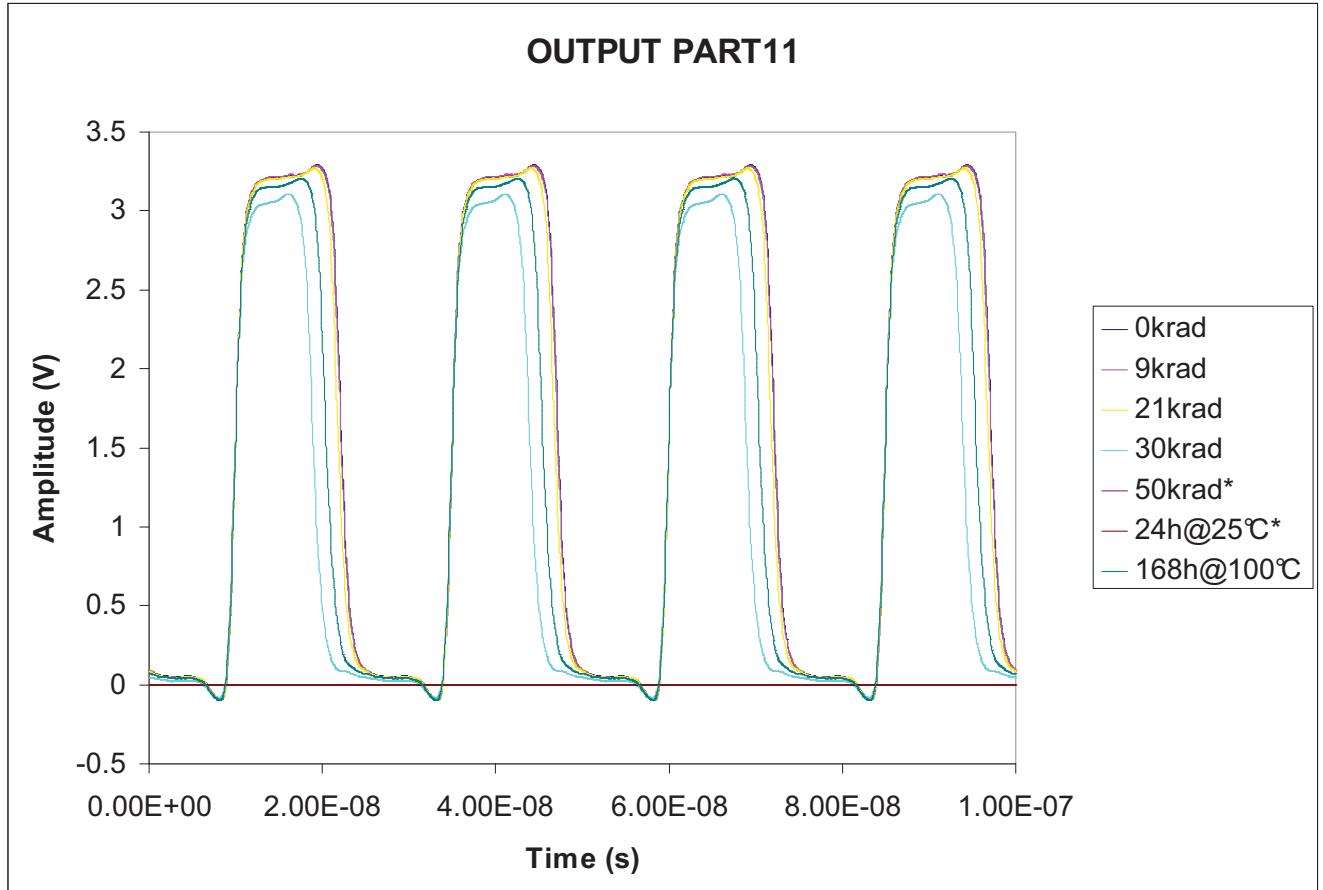

* The 50 krad and 24h@25°C curves are superimposed at 0V amplitude.

12. PART12

Ta = 25°C ; +Vs = +3.3V

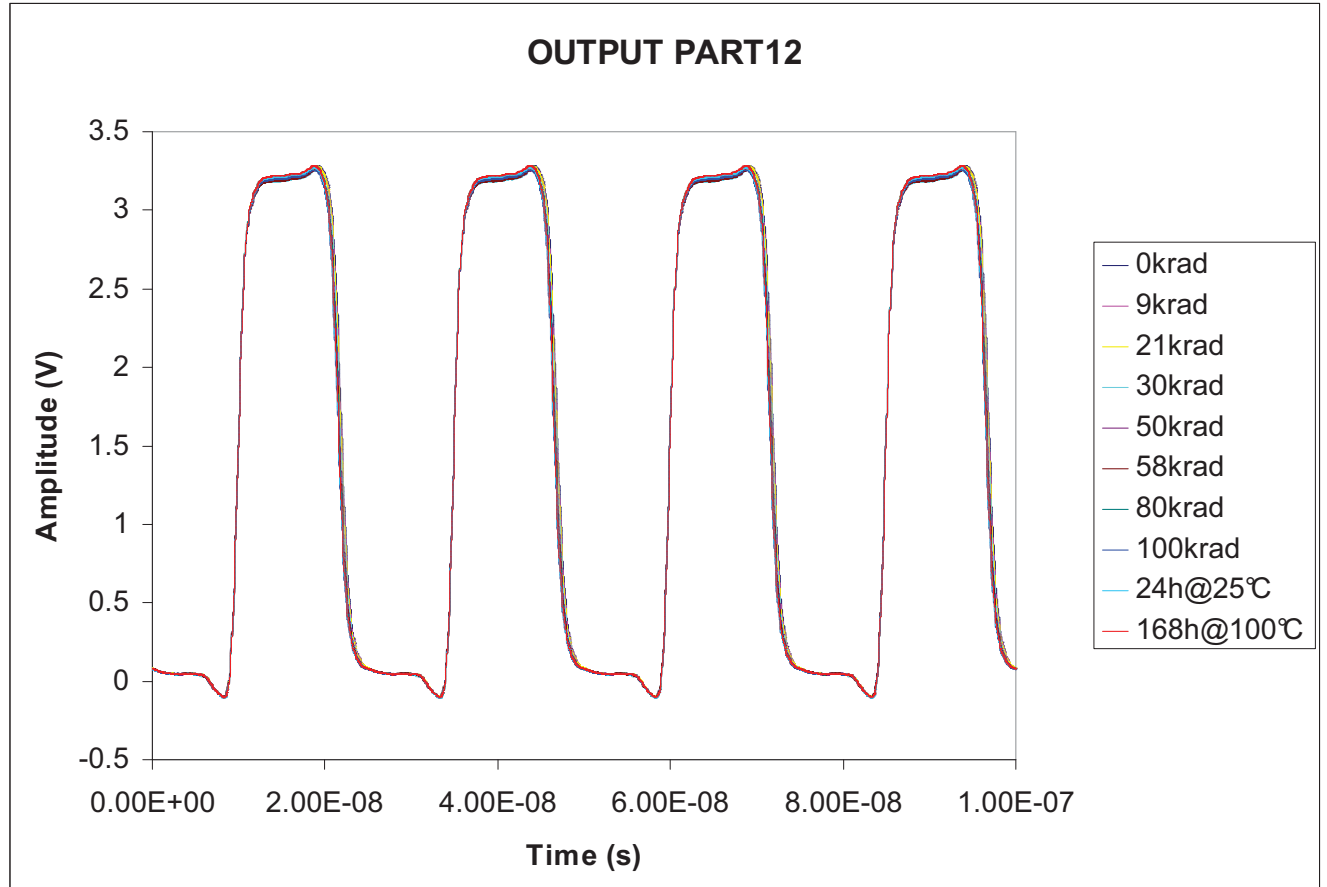

13. PART13

Ta = 25°C ; +Vs = +3.3V

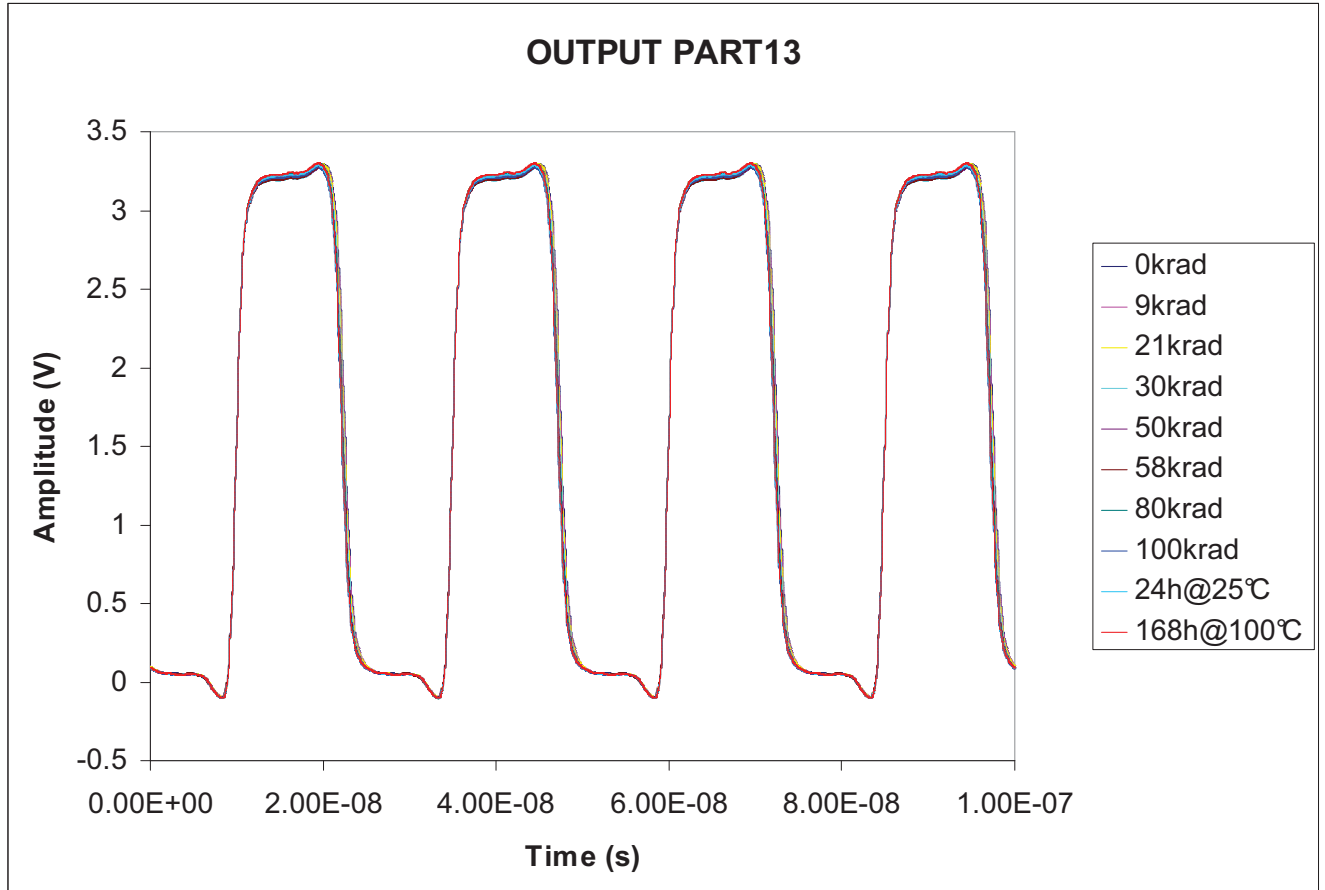

14. PART14

Ta = 25°C ; +Vs = +3.3V

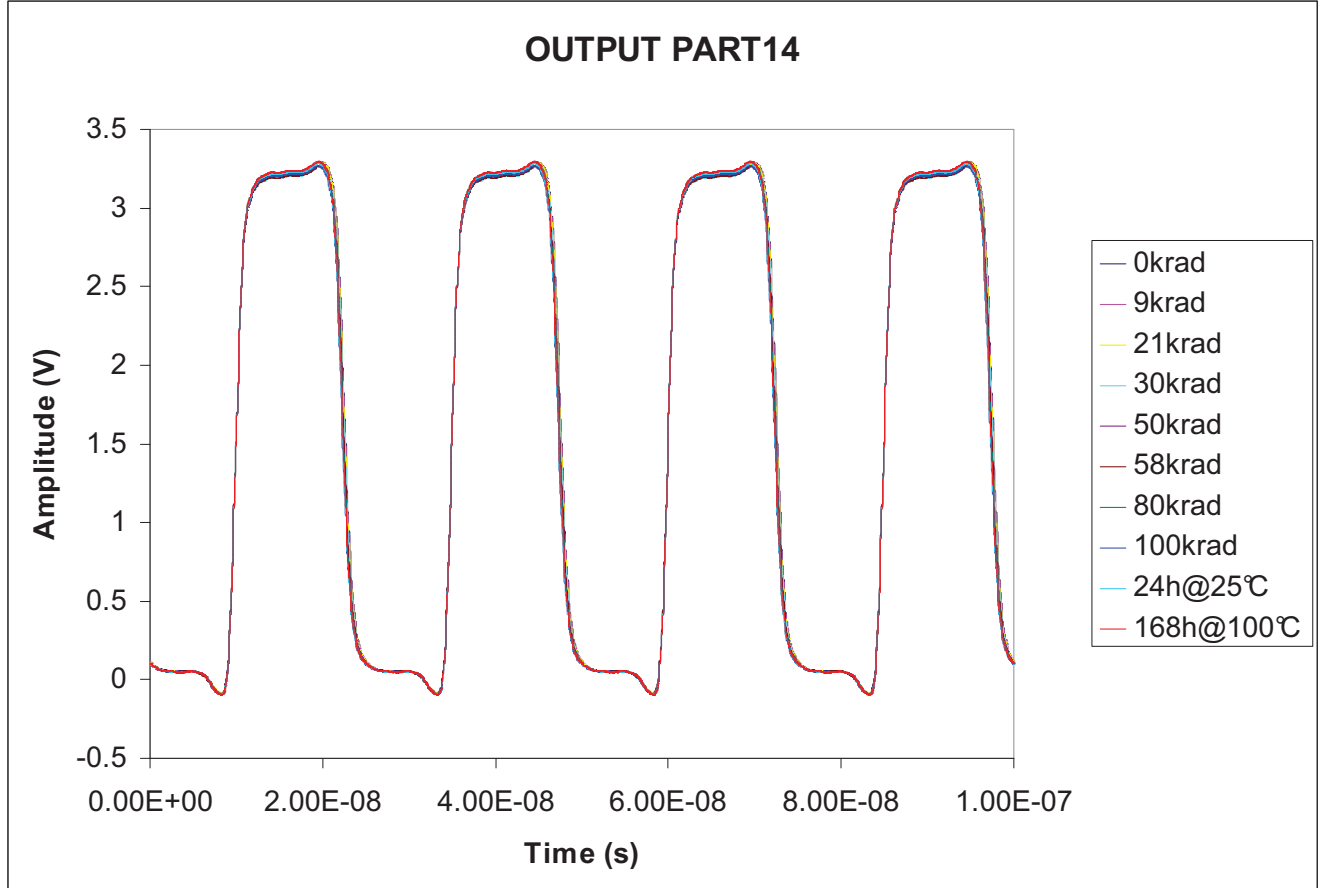

15. PART15

Ta = 25°C ; +Vs = +3.3V

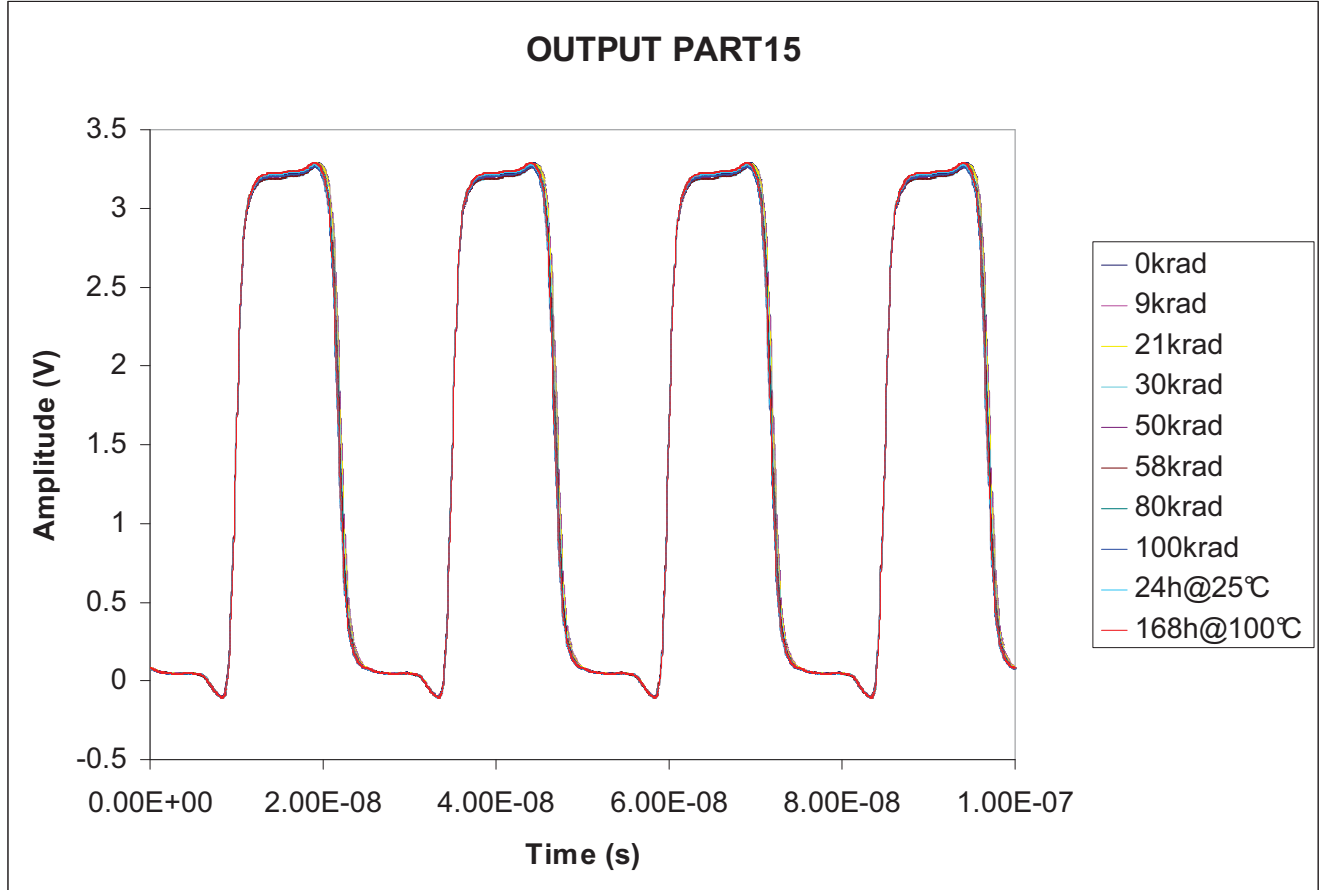

16. PART16

Ta = 25°C ; +Vs = +3.3V

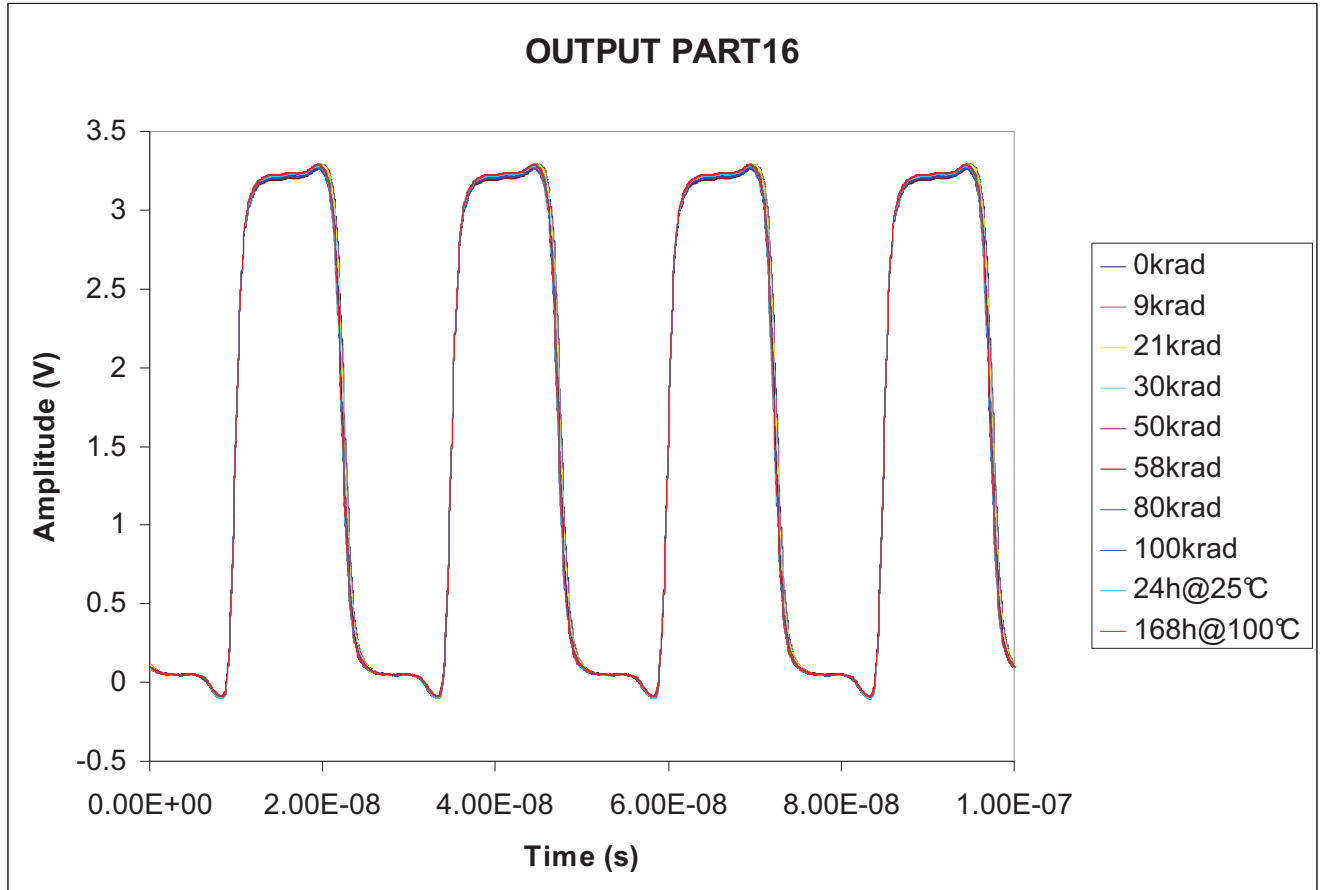

16. APPENDIX E : CURRENT MONITORING

Current monitoring of the 10 parts biased.

