

PROTONS DISPLACEMENT DAMAGE TEST REPORT

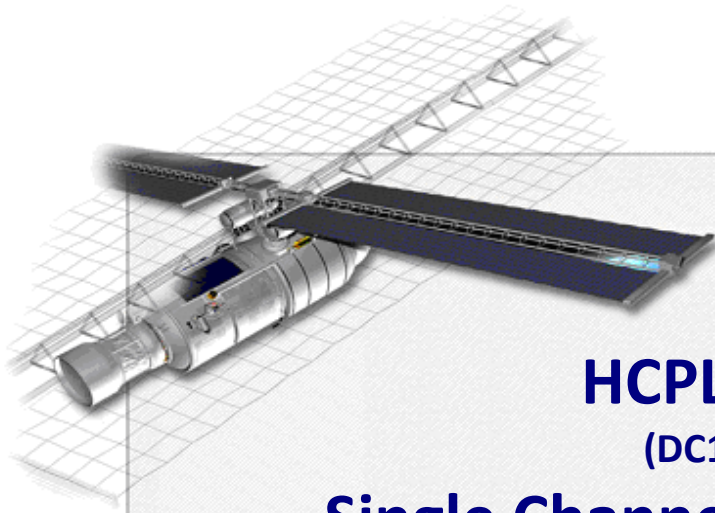

HCPL5501 (DC1105) Single Channel Optocoupler From AVAGO



TRAD/TP/HCPL5501/XXX1/ESA/YP/1104		Labège, April 19th, 2012	
 		TRAD, Bât Gallium 907, Voie l'Occitane - 31670 LABEGE France ☎ : 05 61 00 95 60 Fax : 05 61 00 95 61 Email : trad@trad.fr Web Site: www.trad.fr SIRET 397 862 038 00056 - TVA FR59397862038	
Written by	Verified by / Quality control	Approved by	
A. SAMARAS 10/04/2012	M.SAUVAGNAC/Y.PADIE 19/04/2012	C.CHATRY 19/04/2012	
Issue : 0			
To: Marc POIZAT	Project/Program :	ESA Contract N°4000102571/10/NL/AF-Radiation Characterization of Laplace RH optocouplers, sensors and detectors	

TABLE OF CONTENT

1	INTRODUCTION	3
2	DOCUMENTS	3
2.1	Applicable Documents	3
2.2	Reference Documents.....	3
3	DEVICE INFORMATION	3
3.1	Device description.....	3
3.2	Procurement information	4
3.3	External view.....	4
3.4	Internal view	4
3.5	Serialization.....	5
4	IRRADIATION MEANS AND CONDITIONS	6
4.1	AGORFIRM/KVI irradiation facility (The Netherlands)	6
4.2	Energy and Flux measurement	6
4.3	Experimental conditions	6
5	ELECTRICAL TESTS.....	7
5.1	Test set-up	7
5.2	Test configuration	7
5.3	Electrical parameters	8
6	TEST HISTORY	8
7	SUMMARY RESULTS.....	9
7.1	30 MeV proton irradiation summary results	9
7.2	60 MeV proton irradiation summary results	11
7.3	190 MeV proton irradiation summary results	12
8	CONCLUSION	13
9	DETAILED TESTS RESULTS.....	15

LIST OF FIGURES

Figure 1:	package marking.....	4
Figure 2:	package back.....	4
Figure 3:	package view	4
Figure 4:	Internal general view	4
Figure 5:	detail views of dice and LED marking	5
Figure 6:	samples installed for irradiation.....	6
Figure 7:	test principle	7
Figure 8:	ON bias1	8
Figure 9:	ON bias2	8
Figure 10:	ON Bias 1 under 30 MeV protons	9
Figure 11:	ON Bias 2 under 30 MeV protons	9
Figure 12:	OFF Bias under 30 MeV protons.....	9
Figure 13:	CTR3 function 30 MeV proton irradiation step for each component	10
Figure 14:	TPHL function 30 MeV proton irradiation step for each component	10
Figure 15:	ON Bias 1 under 60 MeV protons	11
Figure 16:	ON Bias 2 under 60 MeV protons	11
Figure 17:	OFF Bias under 60 MeV protons.....	11
Figure 18:	ON Bias 1 under 190 MeV protons	12
Figure 19:	ON Bias 2 under 190 MeV protons	12
Figure 20:	OFF Bias under 190 MeV protons.....	12
Figure 21:	Average drift current transfer ratio under 30 MeV proton.....	14
Figure 22:	Average drift current transfer ratio under 60 MeV proton.....	14
Figure 23:	Average drift current transfer ratio under 190 MeV proton.....	14

1 INTRODUCTION

This report includes the test results of HCPL5501, a Single Channel Optocoupler from AVAGO to evaluate displacement damage effects under proton irradiation. During January and February 2012, TRAD characterized this device for proton sensitivity at the KVI Facility, in GRONINGEN, The Netherlands using their AGOR cyclotron.

The objectives of the test are:

- to detect and measure the degradation of device parameters as a function of proton fluence,
- to determine if device parameters are within specified limits after exposure to final level of proton fluence.

2 DOCUMENTS

2.1 Applicable Documents

AD	1.	ESA contract	N°4000102571/10/NL/AF-Radiation Characterization of Laplace RH optocouplers, sensors and detectors
AD	2.	Irradiation Test Plan	ITP-TP- HCPL5501-MIC-ESA-1119, Iss.3, 08/02/2012

2.2 Reference Documents

RD	1.	Datasheet HCPL5501 Datasheet	Hermetically Sealed, Transistor Output Optocouplers for Analog and Digital Applications HCPL-5501 n° 5989-1659EN - June 13, 2007 by AVAGO
RD	2.	AVAGO certificate of conformance dated 09/05/2011	

3 DEVICE INFORMATION

3.1 Device description

The HCPL5501 is a Single Channel hermetically sealed transistor output Optocoupler with a GaAsP light emitting diode for Analog and Digital Applications.

Type	HCPL5501 – 5962-9085401HPC
Manufacturer	AVAGO
Function	Optocoupler
Package	DIP8
Date Code	1105
Inspection Lot	HS110403
LPN	DS10742240
Sample size	46 parts (45 + 1 control sample)

3.2 Procurement information

75 parts HCPL5501 were procured from AVAGO (through ACAL BFI, Germany) with full MIL-PRF-38534 Class Level H testing. Parts were delivered with a certificate of conformance [RD2]. The class H is identifiable by the digit 1 at the end of the part reference.

3.3 External view

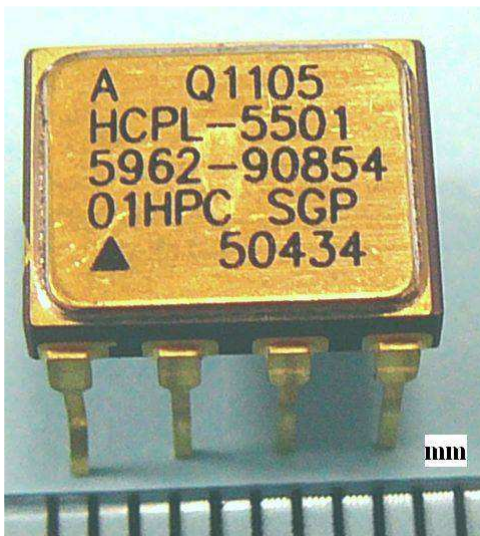

Figure 1: package marking



Figure 2: package back

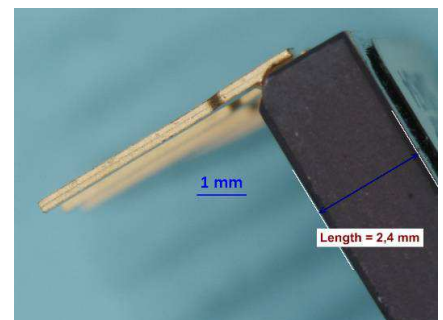

Figure 3: package view

3.4 Internal view

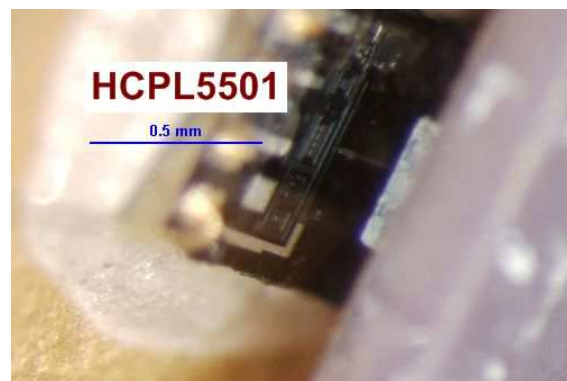
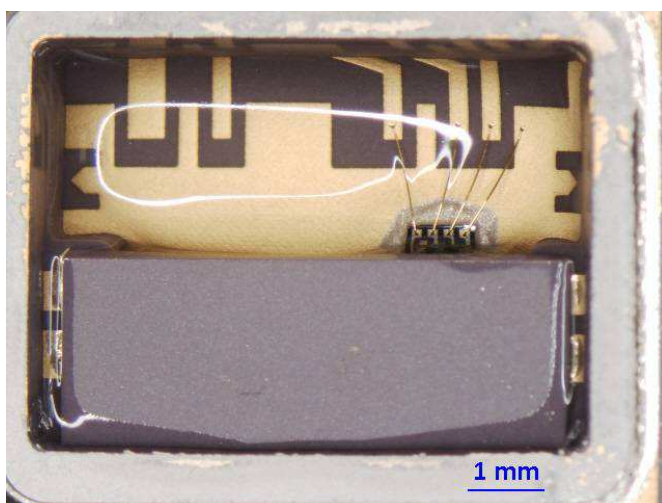

Figure 4: Internal general view

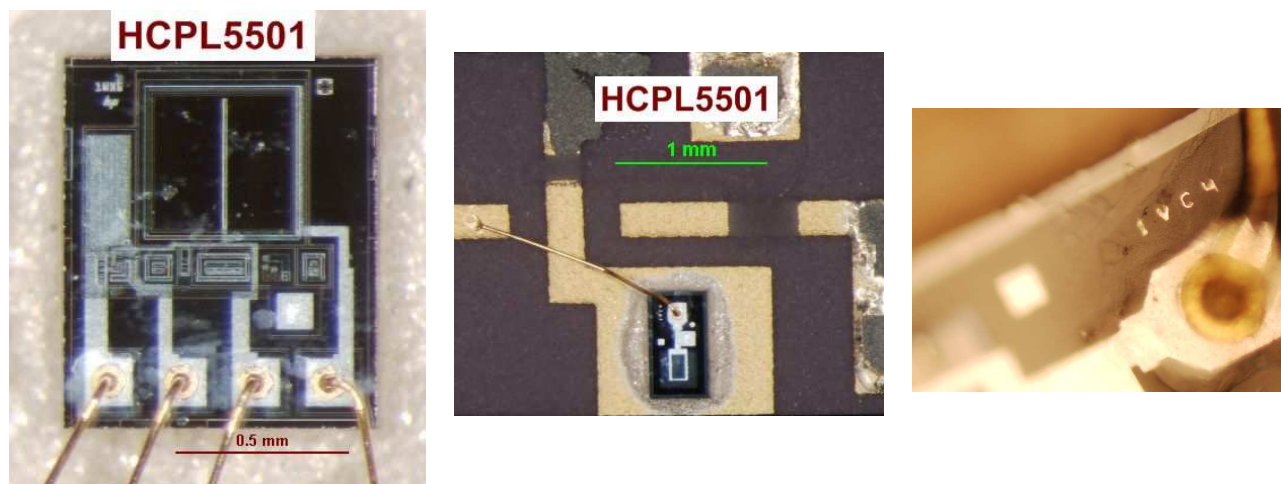

Figure 5: detail views of dice and LED marking

3.5 Serialization

Each part is serialized to enable pre and post test identification and comparison.

Serial Number			
P1 (30MeV)	P2 (60MeV)	P3 (190MeV)	Mode
1 (Control sample)			
2	2	2	Bias 1
3	3	3	Bias 1
4	4	4	Bias 1
5	5	5	Bias 1
6	6	6	Bias 1
7	7	7	Bias 2
8	8	8	Bias 2
9	9	9	Bias 2
10	10	10	Bias 2
11	11	11	Bias 2
12	12	12	Off
13	13	13	Off
14	14	14	Off
15	15	15	Off
16	16	16	Off

4 IRRADIATION MEANS AND CONDITIONS

4.1 AGORFIRM/KVI irradiation facility (The Netherlands)

AGORFIRM is a facility that uses a dedicated beam line of the AGOR cyclotron for irradiations with protons in air. The facility is available for radiation damage studies. The standard proton beams used for irradiations produced by this cyclotron have primary energies of 90, 150 and 190 MeV. The standard irradiation field has a diameter of 70 mm and homogeneity of better than $\pm 3\%$.



Figure 6: samples installed for irradiation

4.2 Energy and Flux measurement

The energy resolution of the beam when leaving the cyclotron is typically better than 0.25%. However, at the DUT position the resolution is in the order of a few MeV due to scattering in air, the scatter system and, when used, the energy degrader.

The proton flux at the centre of the irradiation field is measured with a 10 mm diameter scintillator detector. During the irradiation, the flux is monitored with a Beam Intensity Monitor (BIM). Before an irradiation the BIM signal (in Monitor Units) is related to the scintillator signal to obtain the flux calibration in protons cm^{-2} per MU. This calibration is conducted for every field size and every energy used during an irradiation.

4.3 Experimental conditions

An Equivalent total fluence of $1\text{E}12 \text{ \#/cm}^2$ of 10 MeV protons is required [AD2] for this TNID (Total Non-Ionizing Dose) evaluation test. Considering NIEL (Non Ionizing Energy Loss) value for 10 MeV protons ($7.86\text{E}-03 \text{ MeV cm}^2 \text{ g}^{-1}$), total fluence to be reached for each energy is:

30	MeV	$8,22\text{E}+11 \text{ cm}^{-2}$
60	MeV	$1,14\text{E}+12 \text{ cm}^{-2}$
190	MeV	$1,91\text{E}+12 \text{ cm}^{-2}$

Five steps were defined to determine the component degradation under 30MeV, 60MeV, 190MeV proton irradiation. The test devices have been exposed to the following proton fluence levels:

p/cm2	1,70E+10	8,50E+10	1,70E+11	1,70E+12
Energy (MeV)	30	30	30	30
p/cm2	2,30E+10	1,15E+11	2,30E+11	1,14E+12
Energy (MeV)	60	60	60	60
p/cm2	4,00E+10	2,00E+11	4,00E+11	1,91E+12
Energy (MeV)	190	190	190	190

5 ELECTRICAL TESTS

Electrical parameters to be measured in pre and post exposure tests are described in the following table. Electrical tests are performed on each part using the test set-up hereunder. All required data are recorded for each device. Test conditions and limits are given in the applicable irradiation test plan [AD2] and shown hereafter.

5.1 Test set-up

TEST BOARD	TRAD/CT1/N/OPTO/ZIP14/BR/1109
TEST PROGRAM	HCPL5501_TP30MeV_XXX1_B1_V10.Ilb HCPL5501_TP60MeV_XXX1_B1_V10.Ilb HCPL5501_TP200MeV_XXX1_B1_V10.Ilb

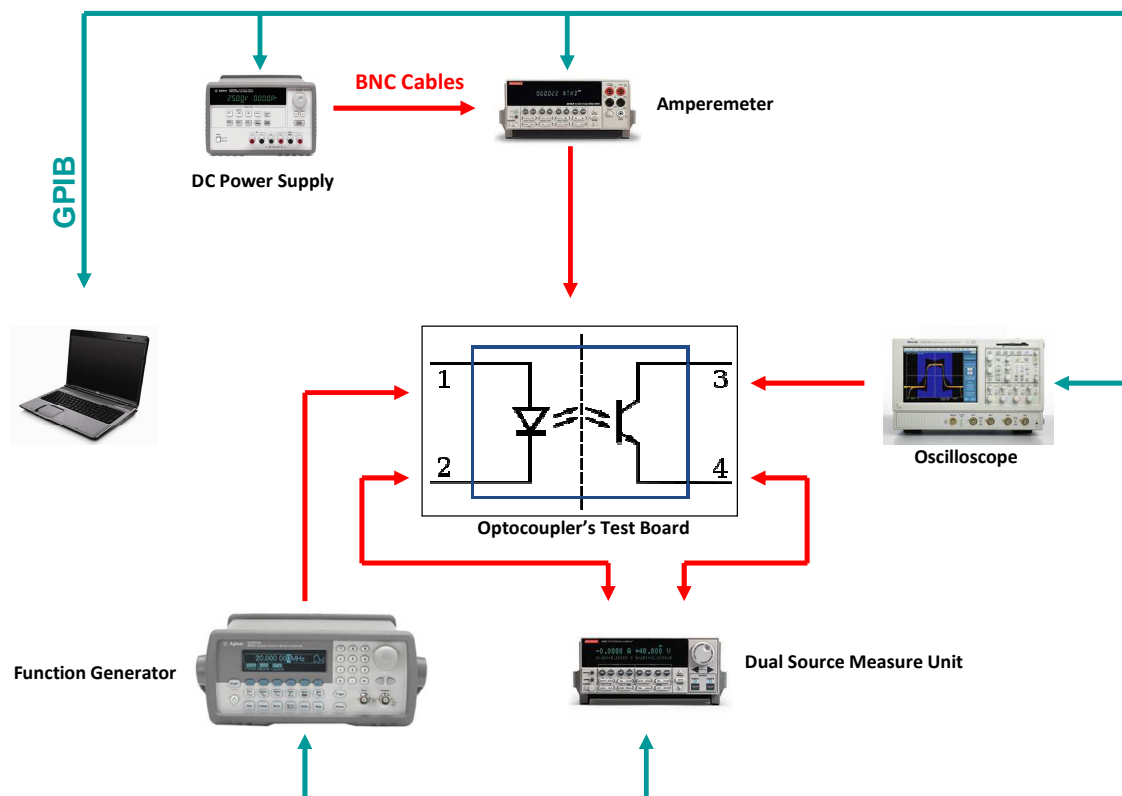

Figure 7: test principle

5.2 Test configuration

Samples were exposed to proton irradiation in three different modes - two on-modes (Figure 8 and Figure 9) and one off-mode (all terminal leads short-circuited) –

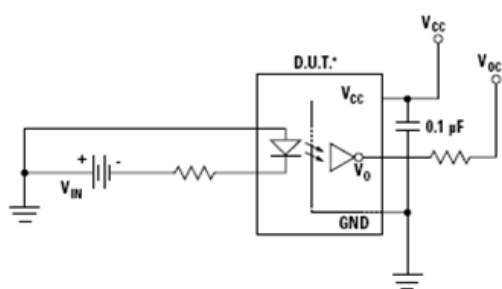

Figure 8: ON bias1

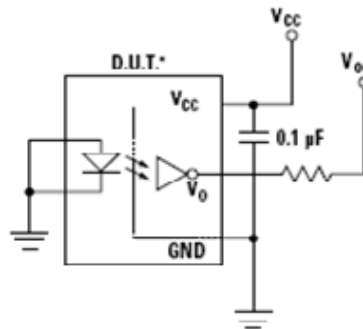

Figure 9: ON bias2

5.3 Electrical parameters

PARAMETER	SYMBOL	TEST CONDITION	MIN	MAX	UNIT
Logic High Output Current	I_{OH}	$I_F = 0, V_O = V_{CC} = 18\text{ V}$		100	μA
Output Leakage Current	I_{OLeak}	$I_F = 250\ \mu\text{A}, V_O = V_{CC} = 18\text{ V}$		250	μA
Input Forward Voltage	V_F	$I_F = 20\text{ mA}$		1.8	V
Reverse Breakdown Voltage	BV_R	$I_R = 10\ \mu\text{A}$	5		V
Logic High Supply Current	I_{CCH}	$V_{CC} = 18\text{ V}, I_F = 0\text{ mA}$		10	μA
Logic Low Supply Current	I_{CCL}	$V_{CC} = 18\text{ V}, I_F = 20\text{ mA}$		200	μA
Propagation Delay Time to Logic High at Output	t_{PLH}^*	$R_L=8.2\text{k}\Omega, C_L=50\text{pF}, I_F=16\text{ mA}, V_{CC}=5\text{ V}^*$		6	μs
Propagation Delay Time to Logic Low at Output	t_{PHL}^*	$R_L=8.2\text{k}\Omega, C_L=50\text{pF}, I_F=16\text{ mA}, V_{CC}=5\text{ V}$		2	μs
Current Transfer Ratio	CTR1	$V_O=0.4\text{V}, I_F=2\text{ mA}, V_{CC}=5\text{V}$			%
	CTR2	$V_O=0.4\text{V}, I_F=4\text{ mA}, V_{CC}=5\text{V}$			%
	CTR3	$V_O=0.4\text{V}, I_F=16\text{ mA}, V_{CC}=4.5\text{V}$	9		%
	CTR4	$V_O=0.4\text{V}, I_F=20\text{ mA}, V_{CC}=5\text{V}$			%
	CTR5	$V_O=0.4\text{V}, I_F=40\text{ mA}, V_{CC}=5\text{V}$			%
	CTR6	$V_O=0.4\text{V}, I_F=20\text{ mA}, V_{CC}=18\text{V}$			%

(*) t_{PHL} propagation delay is measured from the 50% point on the rising edge of the input current pulse to the 1.5 V point on the falling edge of the output pulse. The t_{PLH} propagation delay is measured from the 50% point on the falling edge of the input current pulse to the 1.5 V point on the rising edge of the output pulse.

Min/ Max values are those specified in the reference data-sheet [RD1].
Test measurements are performed at $20^\circ\text{C} \pm 10^\circ\text{C}$.

6 TEST HISTORY

Test sequence and all required conditions were executed as described in the test plan.
No incident during the test was noticed.

7 SUMMARY RESULTS

7.1 30 MeV proton irradiation summary results

Only the parameters with applicable test limits are shown hereunder.

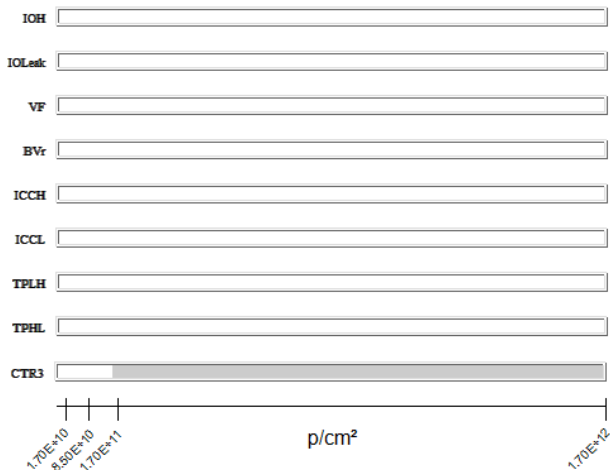

Figure 10: ON Bias 1 under 30 MeV protons

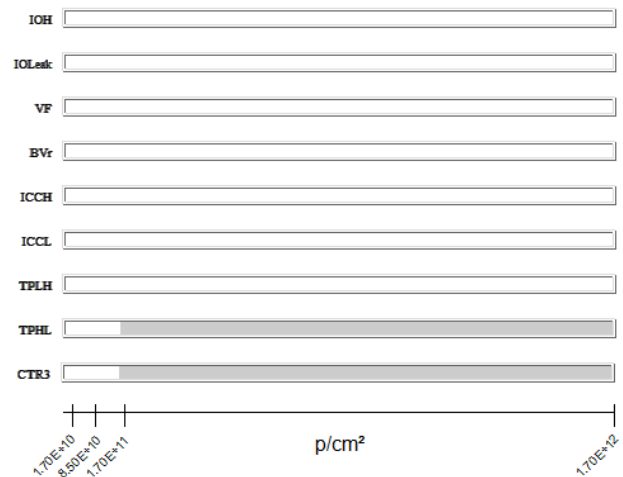

Figure 11: ON Bias 2 under 30 MeV protons

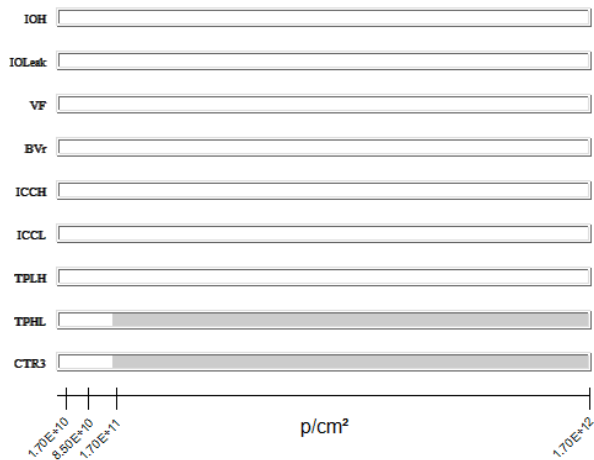
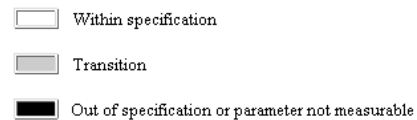

Figure 12: OFF Bias under 30 MeV protons



The parameter CTR3 is out of specification, whatever the Bias mode, at step 1.7E12.p/cm²:

- The parameter CTR3 , with the condition ON Bias1, is out of specification at 1.67E+12.p/cm² by interpolation
- The Figure 11 shows that, with the condition ON Bias2, the parameter CTR3 is out of specification at 1.51 E+12.p/cm² by interpolation
- In OFF mode, the parameter CTR3 is out of specification at 1.45 E+12.p/cm² by interpolation

As shown in the Figure hereunder, among all devices tested, only two devices in ON Bias1 mode are out of specification at step 1.7 E12.p/cm² for the CTR3 parameter. However, all devices tested in OFF mode and in ON Bias2 mode are out of specification for this parameter.

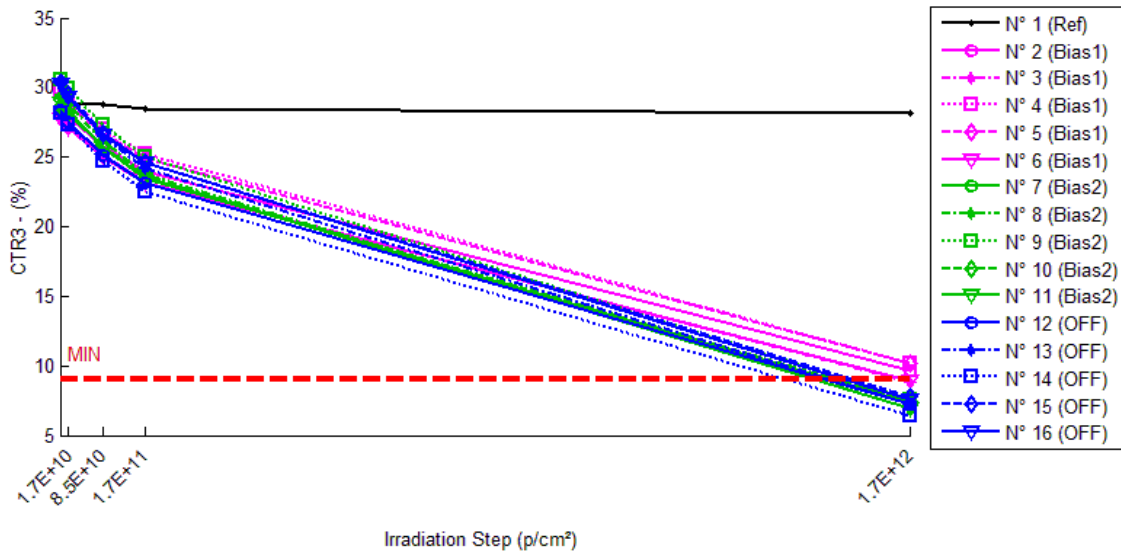

Figure 13: CTR3 function 30 MeV proton irradiation step for each component

Figure 11, Figure 12 and Figure 14 show that, for all components tested, the parameter TPHL is out of specification:

- ON Bias2 : at 1.22 E+12.p/cm² by interpolation
- OFF : at 1.13 E+12.p/cm² by interpolation

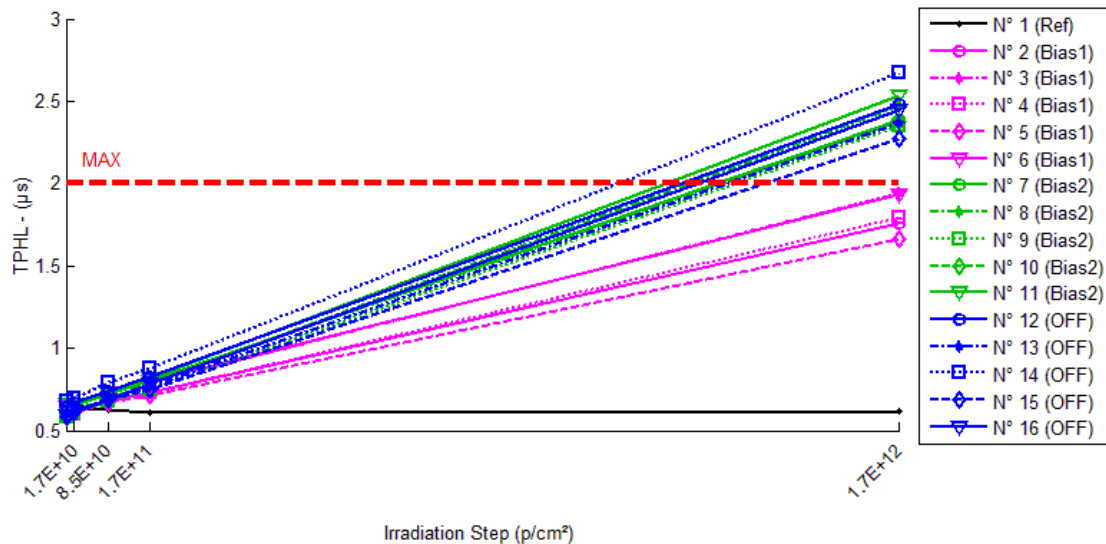

Figure 14: TPHL function 30 MeV proton irradiation step for each component

7.2 60 MeV proton irradiation summary results

Only the parameters with applicable test limits are shown hereunder.

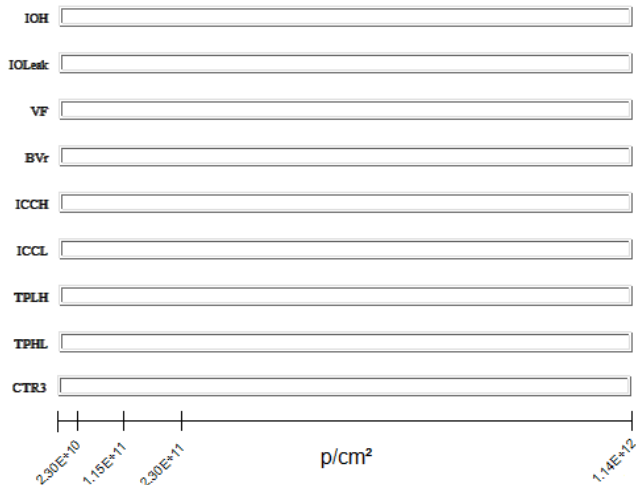

Figure 15: ON Bias 1 under 60 MeV protons

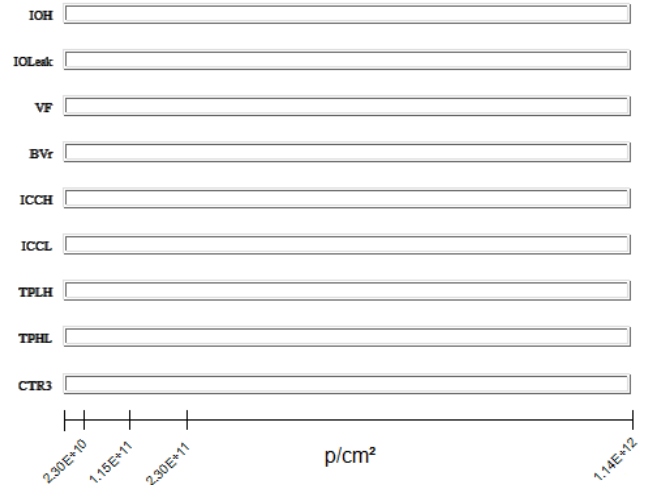

Figure 16: ON Bias 2 under 60 MeV protons

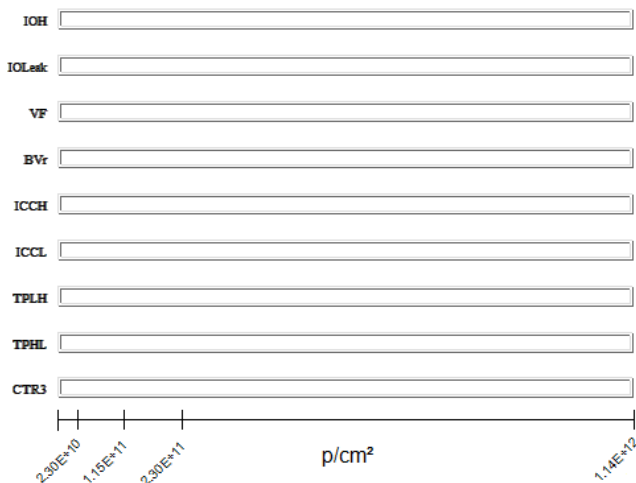
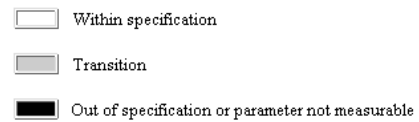

Figure 17: OFF Bias under 60 MeV protons



For all devices tested and whatever the bias condition, all parameters are within the specified values at the final step **1.14E12.p/cm²**.

7.3 190 MeV proton irradiation summary results

Only the parameters with applicable test limits are shown hereunder.

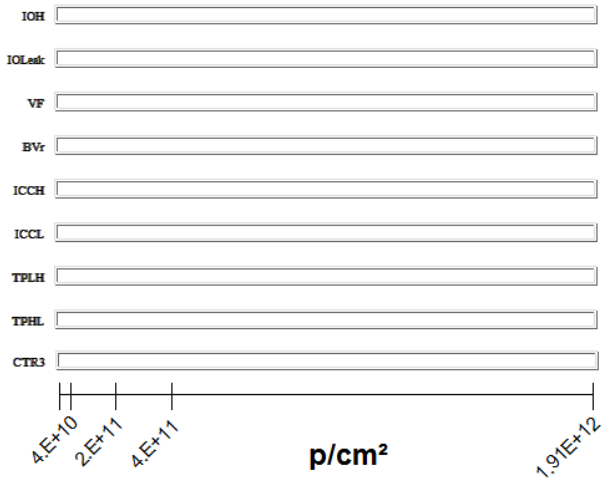

Figure 18: ON Bias 1 under 190 MeV protons

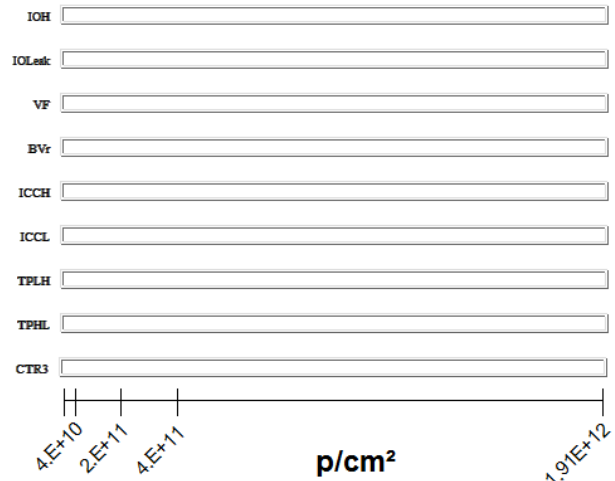

Figure 19: ON Bias 2 under 190 MeV protons

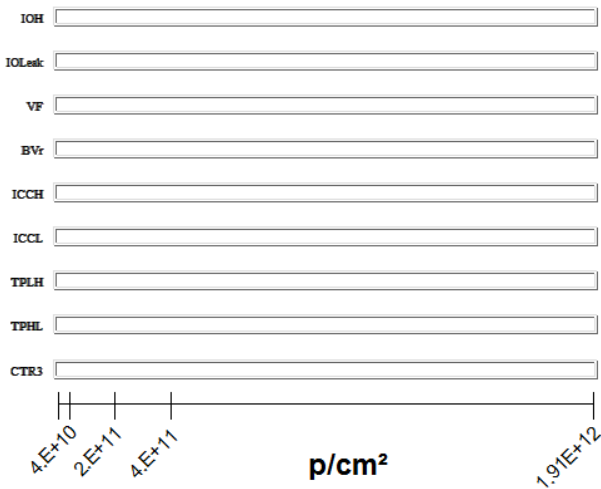

Figure 20: OFF Bias under 190 MeV protons

- Within specification
- Transition
- Out of specification or parameter not measurable

For all devices tested and whatever the bias condition, all parameters are within the specified values at the final step **1.91E12.p/cm²**.

8 CONCLUSION

Total fluence steady-state irradiation test using protons has been applied on HCPL5501, a Single Channel Optocoupler from AVAGO:

- up to 1.7E+12 protons/cm², with an energy of 30 MeV
- up to 1,14E+12 protons/cm², with an energy of 60 MeV
- up to 1,91E+12 protons/cm², with an energy of 190 MeV

The results indicate that:

- Under 30MeV proton Beam:

All devices are functional up to 1.7 E+11 protons/cm² total fluence level.

The CTR3 parameter is out of specification at 1.7E+12 protons/cm² for all devices tested, and TPHL is out of specification at 1.7E+12 protons/cm² in OFF and ON Bias2 condition.

OFF and ON Bias2 conditions are most sensitive to proton displacement damage.

- Under 60MeV proton Beam:

All devices are functional up to 1.14 E+12 protons/cm² total fluence level.

- Under 190MeV proton Beam:

All devices are functional up to 1.91 E+12 protons/cm² total fluence level.

CTR4 configuration ($V_o=0.4V$, $I_f=20$ mA, $V_{cc}=5V$) exhibits the smallest average parameter drift whatever the Bias condition. Conversely, CRT1 configuration ($V_o=0.4V$, $I_f=2$ mA, $V_{cc}=5V$) exhibits the greater parameter degradation.

Moreover, CTR3 ($V_o=0.4V$, $I_f=16$ mA, $V_{cc}=4.5V$), which is the only CTR configuration subject to specification, is out of specification at step 1.7E12p/cm² under 30 MeV protons.

The least sensitive configuration for all CTR configuration is observed with the ON Bias1 configuration.

Conversely, OFF mode is the most sensitive configuration.

As shown in Figure 21, Figure 22 and Figure 23, for some CTR configurations, average CTR drifts are almost the same for OFF and ON Bias 2 configurations.

Moreover CTR3 ($V_o=0.4V$, $I_f=16$ mA, $V_{cc}=4.5V$), which is the only CTR configuration subject to specification, is out of specification at final step, 1.7E12p/cm² with 30MeV protons.

Average drift current transfer ratio are represented in next Figures depending proton energy, CTR configuration and Bias condition at final irradiation step.

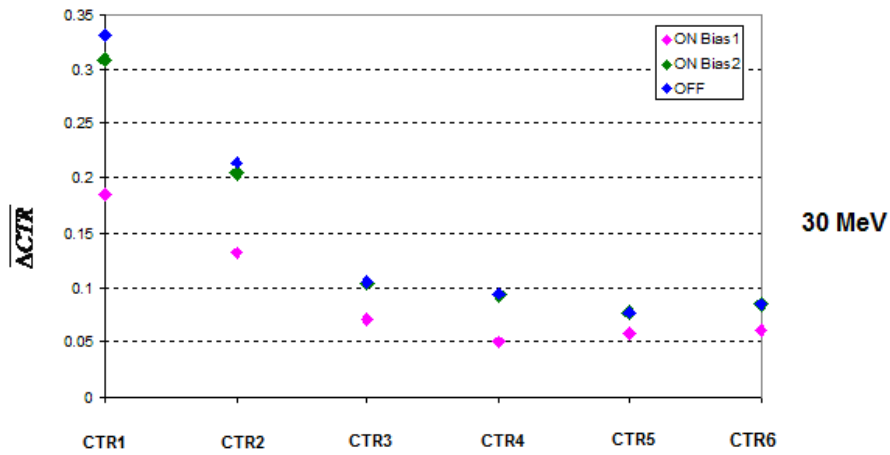

Figure 21: Average drift current transfer ratio under 30 MeV proton

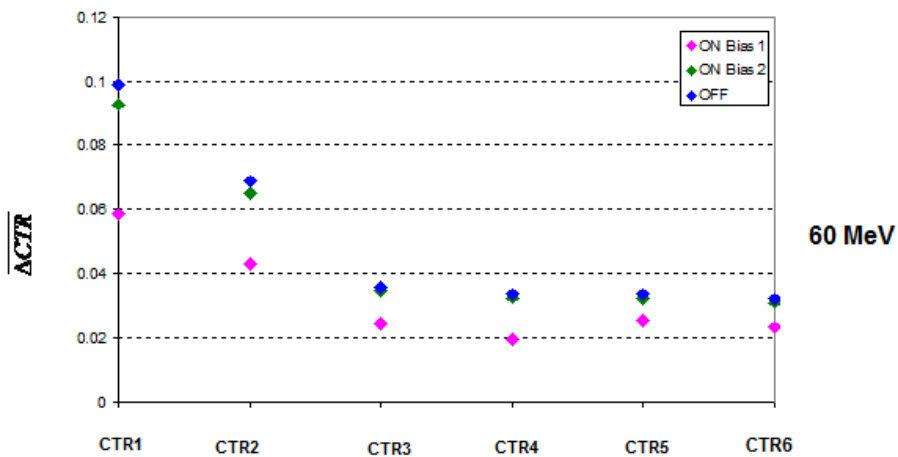

Figure 22: Average drift current transfer ratio under 60 MeV proton

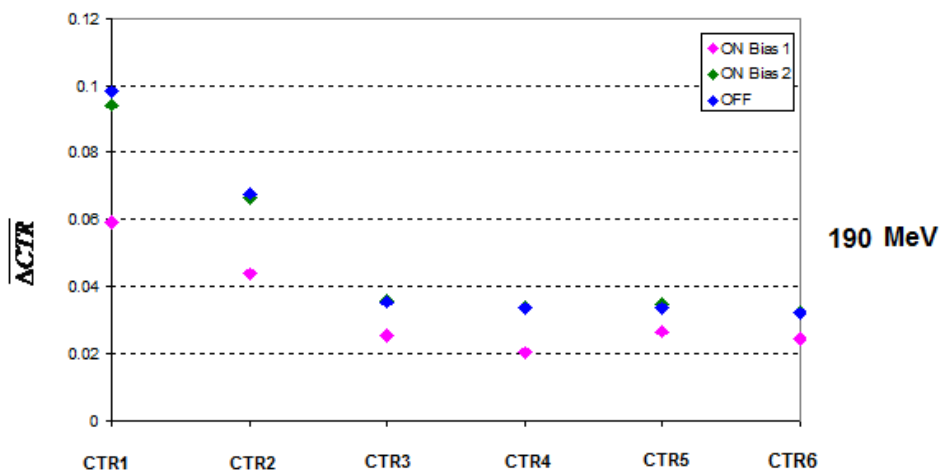

Figure 23: Average drift current transfer ratio under 190 MeV proton

9 DETAILED TESTS RESULTS

The pre and post radiation test results are shown graphically in the following pages

- 30MeV: 9-2 to 9-29
- 60MeV: 10-2 to 10-29
- 190MeV: 11-2 to 11-29

The data is displayed in the following tables and graphs.

These graphs show parameter's shifts observed during the proton irradiation sequence. The control sample results are shown on each graph (black curve).

When available in the device data-sheet/specification, the maximum/minimum/typical values are also shown (red dotted line).

The tables include drift calculation between each measurement step and the "0" proton/cm² step.

For CTR values, the formula used is:

$$\text{Drift} = \frac{1}{\text{measurement (X protons /cm}^2\text{)}} - \frac{1}{\text{measurement (0 proton /cm}^2\text{)}}$$

For the other measurements the formula used is:

$$\text{Drift value} = \text{measurement (X protons/cm}^2\text{)} - \text{measurement (0 proton/cm}^2\text{)}$$

30 MeV proton / detailed results

CONTENTS

1. IOH	2
2. IOLeak	4
3. VF	6
4. BVr	8
5. ICCH.....	10
6. ICCL	12
7. TPLH	14
8. TPHL	16
9. CTR1	18
10. CTR2	20
11. CTR3	22
12. CTR4	24
13. CTR5	26
14. CTR6	28

30 MeV proton / detailed results

1. IOH

Ta=25°C; If=0; Vo=Vcc=18V

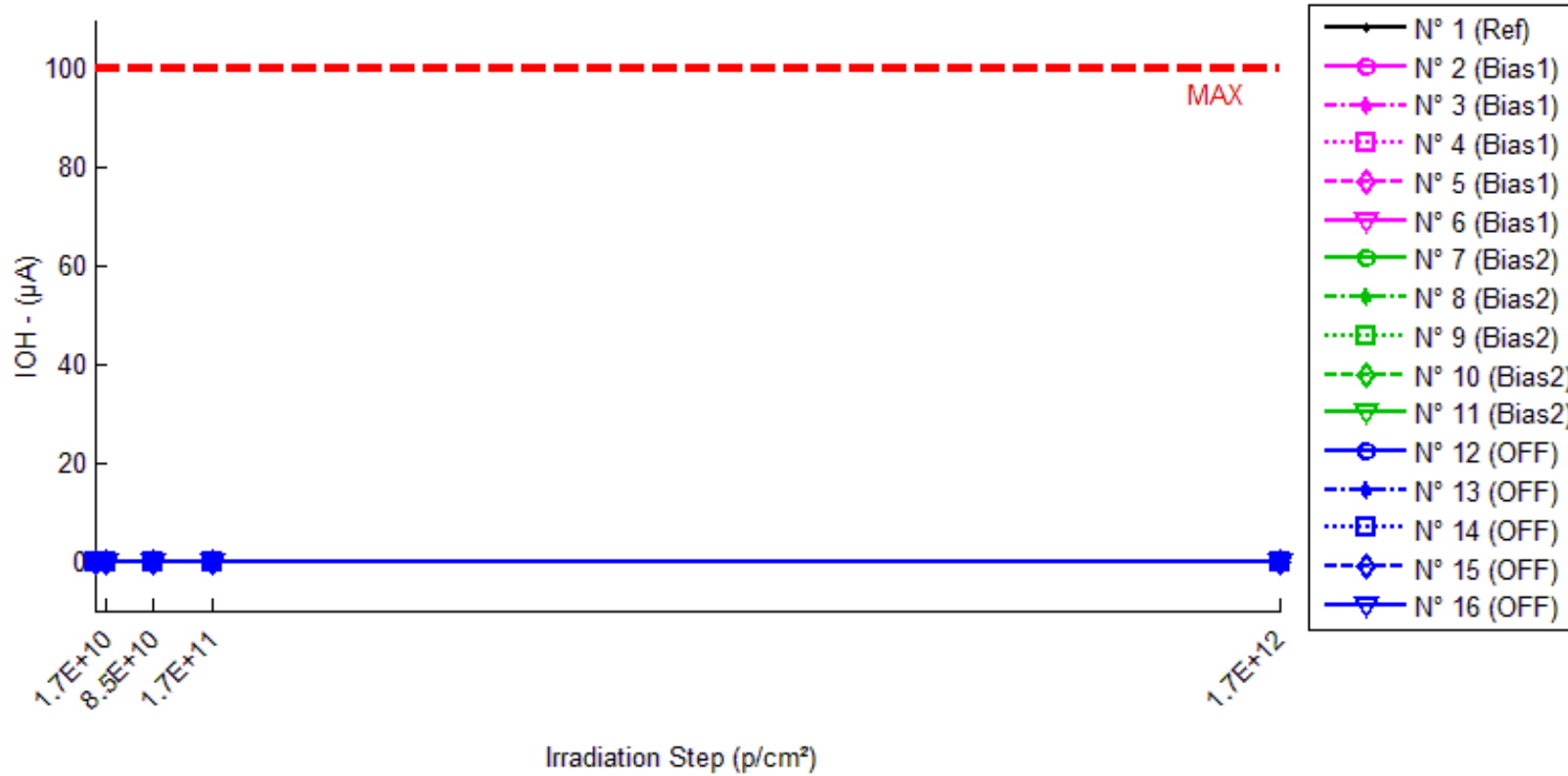

30 MeV proton / detailed results

IOH. (µA) Max = 100.0

	0.p/cm ²	1.7E10.p/cm ²	8.5E10.p/cm ²	1.7E11.p/cm ²	1.7E12.p/cm ²
N° 1 (Ref)	5.337E-4	4.528E-4	5.529E-4	2.214E-4	2.070E-4
N° 2 (Bias1)	4.783E-4	5.200E-4	7.529E-4	9.939E-4	1.564E-3
N° 3 (Bias1)	3.276E-4	2.797E-4	7.479E-4	9.936E-4	1.331E-3
N° 4 (Bias1)	5.585E-4	5.116E-4	9.386E-4	1.200E-3	1.664E-3
N° 5 (Bias1)	4.107E-4	4.775E-4	7.206E-4	9.794E-4	1.395E-3
N° 6 (Bias1)	4.941E-4	5.078E-4	8.128E-4	9.779E-4	1.321E-3
N° 7 (Bias2)	5.527E-4	1.830E-4	1.826E-4	1.923E-4	8.725E-4
N° 8 (Bias2)	5.612E-4	1.917E-4	1.658E-4	1.823E-4	7.131E-4
N° 9 (Bias2)	5.719E-4	1.943E-4	1.826E-4	1.908E-4	9.205E-4
N° 10 (Bias2)	6.054E-4	1.820E-4	1.858E-4	1.846E-4	8.953E-4
N° 11 (Bias2)	4.901E-4	1.865E-4	1.803E-4	1.899E-4	8.788E-4
N° 12 (OFF)	6.035E-4	7.260E-4	7.821E-4	7.730E-4	5.588E-4
N° 13 (OFF)	5.548E-4	7.162E-4	6.045E-4	6.868E-4	4.947E-4
N° 14 (OFF)	5.224E-4	4.953E-4	6.893E-4	6.144E-4	5.045E-4
N° 15 (OFF)	5.905E-4	5.783E-4	7.566E-4	8.145E-4	5.355E-4
N° 16 (OFF)	5.742E-4	6.938E-4	8.229E-4	6.653E-4	5.223E-4

Delta [IOH]

	0.p/cm ²	1.7E10.p/cm ²	8.5E10.p/cm ²	1.7E11.p/cm ²	1.7E12.p/cm ²
N° 1 (Ref)	---	-8.089E-5	1.923E-5	-3.123E-4	-3.267E-4
N° 2 (Bias1)	---	4.171E-5	2.747E-4	5.156E-4	1.086E-3
N° 3 (Bias1)	---	-4.795E-5	4.203E-4	6.660E-4	1.003E-3
N° 4 (Bias1)	---	-4.690E-5	3.801E-4	6.411E-4	1.106E-3
N° 5 (Bias1)	---	6.677E-5	3.099E-4	5.688E-4	9.843E-4
N° 6 (Bias1)	---	1.362E-5	3.187E-4	4.838E-4	8.272E-4
N° 7 (Bias2)	---	-3.696E-4	-3.700E-4	-3.603E-4	3.199E-4
N° 8 (Bias2)	---	-3.696E-4	-3.954E-4	-3.790E-4	1.519E-4
N° 9 (Bias2)	---	-3.775E-4	-3.892E-4	-3.811E-4	3.487E-4
N° 10 (Bias2)	---	-4.234E-4	-4.196E-4	-4.208E-4	2.899E-4
N° 11 (Bias2)	---	-3.035E-4	-3.097E-4	-3.002E-4	3.887E-4
N° 12 (OFF)	---	1.225E-4	1.786E-4	1.696E-4	-4.463E-5
N° 13 (OFF)	---	1.614E-4	4.966E-5	1.320E-4	-6.010E-5
N° 14 (OFF)	---	-2.708E-5	1.670E-4	9.208E-5	-1.785E-5
N° 15 (OFF)	---	-1.225E-5	1.661E-4	2.240E-4	-5.502E-5
N° 16 (OFF)	---	1.196E-4	2.487E-4	9.108E-5	-5.196E-5
Average (OFF)	---	5.450E-6	3.407E-4	5.750E-4	1.001E-3
σ (OFF)	---	5.180E-5	5.848E-5	7.833E-5	1.103E-4
Average+3σ (OFF)	---	1.609E-4	5.161E-4	8.100E-4	1.332E-3
Average-3σ (OFF)	---	-1.500E-4	1.653E-4	3.401E-4	6.705E-4
Average (Bias1)	---	-3.687E-4	-3.768E-4	-3.683E-4	2.998E-4
σ (Bias1)	---	4.277E-5	4.147E-5	4.398E-5	9.038E-5
Average+3σ (Bias1)	---	-2.404E-4	-2.524E-4	-2.363E-4	5.709E-4
Average-3σ (Bias1)	---	-4.971E-4	-5.012E-4	-5.002E-4	2.869E-5
Average (Bias2)	---	7.285E-5	1.620E-4	1.417E-4	-4.591E-5
σ (Bias2)	---	8.621E-5	7.150E-5	5.627E-5	1.666E-5
Average+3σ (Bias2)	---	3.315E-4	3.765E-4	3.106E-4	4.064E-6
Average-3σ (Bias2)	---	-1.858E-4	-5.249E-5	-2.708E-5	-9.589E-5

30 MeV proton / detailed results

2. IOLeak

Ta=25°C; If=250µA; Vo=Vcc=18V

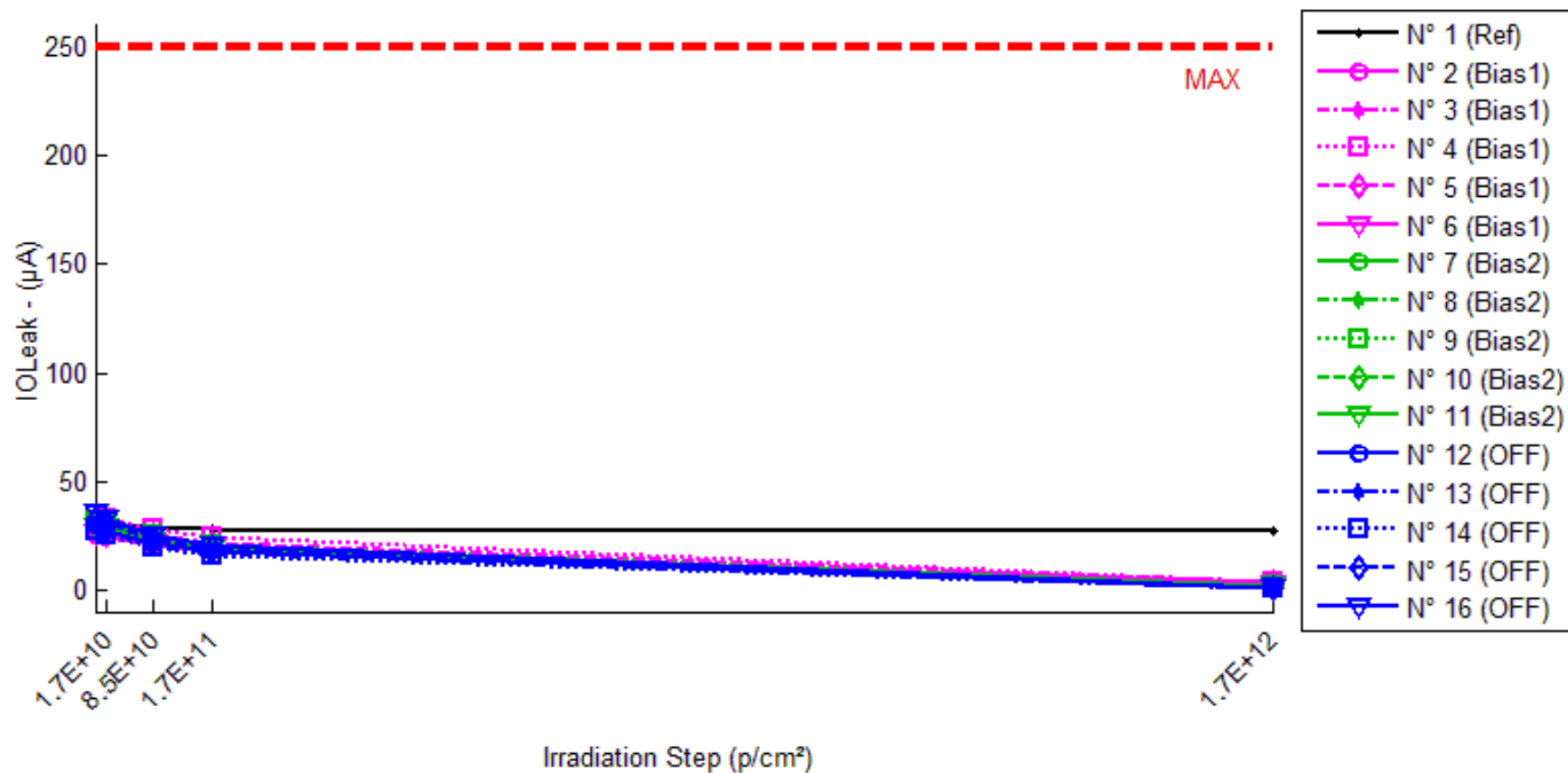

30 MeV proton / detailed results

IOLeak . (µA)

Max = 250.0

	0.p/cm ²	1.7E10.p/cm ²	8.5E10.p/cm ²	1.7E11.p/cm ²	1.7E12.p/cm ²
N° 1 (Ref)	29.601	29.815	28.906	28.287	27.178
N° 2 (Bias1)	24.811	24.054	20.368	17.660	3.320
N° 3 (Bias1)	28.314	27.277	22.939	19.697	3.272
N° 4 (Bias1)	34.348	33.188	28.112	24.425	4.088
N° 5 (Bias1)	30.215	29.212	25.001	21.789	3.992
N° 6 (Bias1)	26.624	25.580	21.912	18.478	3.077
N° 7 (Bias2)	30.399	30.199	24.975	19.563	1.572
N° 8 (Bias2)	28.850	28.112	22.519	17.684	1.228
N° 9 (Bias2)	31.893	31.072	25.061	20.534	1.496
N° 10 (Bias2)	29.891	29.160	23.551	18.775	1.450
N° 11 (Bias2)	29.118	28.688	22.772	18.601	1.317
N° 12 (OFF)	29.849	27.555	21.608	17.794	1.121
N° 13 (OFF)	28.663	26.945	20.637	16.632	0.990
N° 14 (OFF)	27.491	25.226	19.597	15.594	0.887
N° 15 (OFF)	32.821	31.168	23.797	19.621	1.202
N° 16 (OFF)	35.158	32.808	25.430	21.002	1.246

Delta [IOLeak]

	0.p/cm ²	1.7E10.p/cm ²	8.5E10.p/cm ²	1.7E11.p/cm ²	1.7E12.p/cm ²
N° 1 (Ref)	---	2.146E-1	-6.948E-1	-1.314E+0	-2.423E+0
N° 2 (Bias1)	---	-7.568E-1	-4.443E+0	-7.150E+0	-2.149E+1
N° 3 (Bias1)	---	-1.037E+0	-5.375E+0	-8.618E+0	-2.504E+1
N° 4 (Bias1)	---	-1.160E+0	-6.237E+0	-9.923E+0	-3.026E+1
N° 5 (Bias1)	---	-1.004E+0	-5.214E+0	-8.426E+0	-2.622E+1
N° 6 (Bias1)	---	-1.044E+0	-4.711E+0	-8.146E+0	-2.355E+1
N° 7 (Bias2)	---	-2.004E-1	-5.424E+0	-1.084E+1	-2.883E+1
N° 8 (Bias2)	---	-7.378E-1	-6.330E+0	-1.117E+1	-2.762E+1
N° 9 (Bias2)	---	-8.213E-1	-6.832E+0	-1.136E+1	-3.040E+1
N° 10 (Bias2)	---	-7.313E-1	-6.340E+0	-1.112E+1	-2.844E+1
N° 11 (Bias2)	---	-4.307E-1	-6.346E+0	-1.052E+1	-2.780E+1
N° 12 (OFF)	---	-2.295E+0	-8.241E+0	-1.206E+1	-2.873E+1
N° 13 (OFF)	---	-1.718E+0	-8.025E+0	-1.203E+1	-2.767E+1
N° 14 (OFF)	---	-2.265E+0	-7.894E+0	-1.190E+1	-2.660E+1
N° 15 (OFF)	---	-1.653E+0	-9.024E+0	-1.320E+1	-3.162E+1
N° 16 (OFF)	---	-2.349E+0	-9.728E+0	-1.416E+1	-3.391E+1
Average (OFF)	---	-1.000E+0	-5.196E+0	-8.453E+0	-2.531E+1
σ (OFF)	---	1.484E-1	6.925E-1	9.975E-1	3.283E+0
Average+3σ (OFF)	---	-5.552E-1	-3.118E+0	-5.460E+0	-1.546E+1
Average-3σ (OFF)	---	-1.445E+0	-7.273E+0	-1.145E+1	-3.516E+1
Average (Bias1)	---	-5.843E-1	-6.255E+0	-1.100E+1	-2.862E+1
σ (Bias1)	---	2.609E-1	5.110E-1	3.279E-1	1.107E+0
Average+3σ (Bias1)	---	1.985E-1	-4.722E+0	-1.002E+1	-2.530E+1
Average-3σ (Bias1)	---	-1.367E+0	-7.788E+0	-1.198E+1	-3.194E+1
Average (Bias2)	---	-2.056E+0	-8.583E+0	-1.267E+1	-2.971E+1
σ (Bias2)	---	3.404E-1	7.757E-1	9.839E-1	3.002E+0
Average+3σ (Bias2)	---	-1.035E+0	-6.255E+0	-9.716E+0	-2.070E+1
Average-3σ (Bias2)	---	-3.077E+0	-1.091E+1	-1.562E+1	-3.871E+1

30 MeV proton / detailed results

3. VF

Ta = 25°C ; If = 20mA

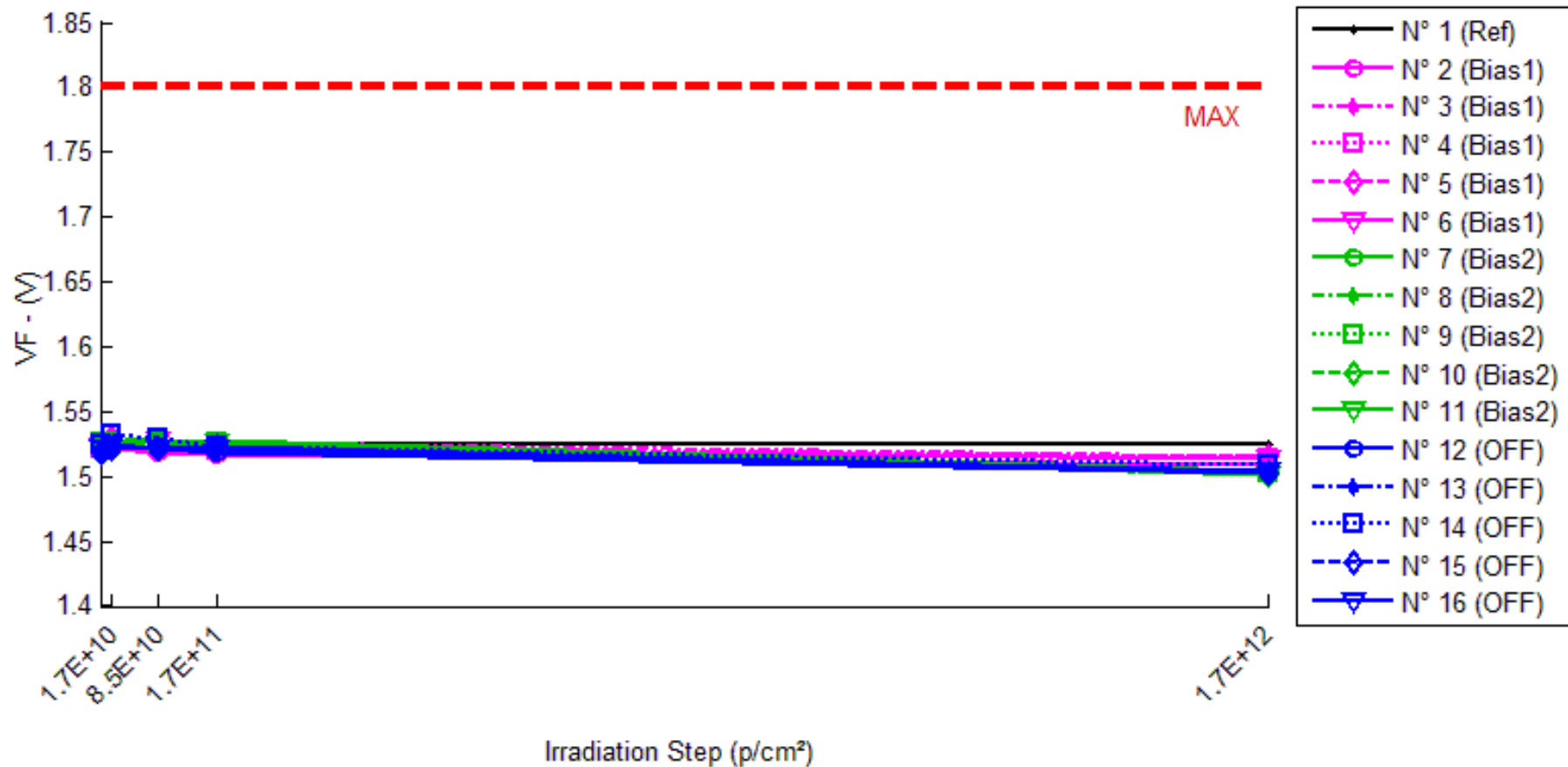

30 MeV proton / detailed results

VF . (V)

Max = 1.8

	0,p/cm ²	1.7E10.p/cm ²	8.5E10.p/cm ²	1.7E11.p/cm ²	1.7E12.p/cm ²
N° 1 (Ref)	1.526	1.526	1.526	1.527	1.525
N° 2 (Bias1)	1.519	1.522	1.519	1.517	1.509
N° 3 (Bias1)	1.525	1.530	1.528	1.527	1.516
N° 4 (Bias1)	1.521	1.527	1.523	1.520	1.513
N° 5 (Bias1)	1.524	1.530	1.523	1.523	1.516
N° 6 (Bias1)	1.523	1.526	1.528	1.522	1.513
N° 7 (Bias2)	1.524	1.528	1.527	1.528	1.504
N° 8 (Bias2)	1.526	1.528	1.528	1.527	1.505
N° 9 (Bias2)	1.527	1.527	1.526	1.526	1.503
N° 10 (Bias2)	1.521	1.525	1.524	1.524	1.501
N° 11 (Bias2)	1.521	1.526	1.522	1.526	1.501
N° 12 (OFF)	1.518	1.522	1.521	1.519	1.503
N° 13 (OFF)	1.518	1.524	1.521	1.523	1.502
N° 14 (OFF)	1.524	1.533	1.530	1.523	1.509
N° 15 (OFF)	1.518	1.521	1.521	1.523	1.503
N° 16 (OFF)	1.521	1.524	1.522	1.522	1.505

Delta [VF]

	0,p/cm ²	1.7E10.p/cm ²	8.5E10.p/cm ²	1.7E11.p/cm ²	1.7E12.p/cm ²
N° 1 (Ref)	---	1.700E-5	-4.140E-4	6.650E-4	-1.021E-3
N° 2 (Bias1)	---	2.979E-3	6.500E-5	-1.482E-3	-1.010E-2
N° 3 (Bias1)	---	4.580E-3	2.989E-3	2.289E-3	-8.954E-3
N° 4 (Bias1)	---	6.130E-3	2.059E-3	-6.700E-4	-7.599E-3
N° 5 (Bias1)	---	6.523E-3	-9.050E-4	-9.790E-4	-7.338E-3
N° 6 (Bias1)	---	3.366E-3	5.338E-3	-1.074E-3	-9.366E-3
N° 7 (Bias2)	---	3.790E-3	3.093E-3	4.113E-3	-1.994E-2
N° 8 (Bias2)	---	1.977E-3	1.733E-3	1.616E-3	-2.111E-2
N° 9 (Bias2)	---	-2.010E-4	-1.259E-3	-8.750E-4	-2.432E-2
N° 10 (Bias2)	---	4.568E-3	3.490E-3	3.602E-3	-1.998E-2
N° 11 (Bias2)	---	5.412E-3	1.556E-3	5.515E-3	-1.941E-2
N° 12 (OFF)	---	3.852E-3	2.090E-3	4.350E-4	-1.504E-2
N° 13 (OFF)	---	6.028E-3	2.689E-3	5.009E-3	-1.587E-2
N° 14 (OFF)	---	9.724E-3	6.087E-3	-1.570E-4	-1.472E-2
N° 15 (OFF)	---	3.624E-3	3.158E-3	5.357E-3	-1.497E-2
N° 16 (OFF)	---	2.136E-3	1.630E-4	4.100E-4	-1.639E-2
Average (OFF)	---	4.716E-3	1.909E-3	-3.832E-4	-8.672E-3
σ (OFF)	---	1.591E-3	2.463E-3	1.522E-3	1.177E-3
Average+3σ (OFF)	---	9.488E-3	9.298E-3	4.182E-3	-5.142E-3
Average-3σ (OFF)	---	-5.685E-5	-5.480E-3	-4.948E-3	-1.220E-2
Average (Bias1)	---	3.109E-3	1.723E-3	2.794E-3	-2.095E-2
σ (Bias1)	---	2.244E-3	1.865E-3	2.482E-3	1.983E-3
Average+3σ (Bias1)	---	9.840E-3	7.319E-3	1.024E-2	-1.500E-2
Average-3σ (Bias1)	---	-3.621E-3	-3.874E-3	-4.652E-3	-2.690E-2
Average (Bias2)	---	5.073E-3	2.837E-3	2.211E-3	-1.540E-2
σ (Bias2)	---	2.948E-3	2.145E-3	2.726E-3	7.012E-4
Average+3σ (Bias2)	---	1.392E-2	9.271E-3	1.039E-2	-1.329E-2
Average-3σ (Bias2)	---	-3.771E-3	-3.596E-3	-5.968E-3	-1.750E-2

30 MeV proton / detailed results

4. BVr

Ta=25°C; Ir=10μA

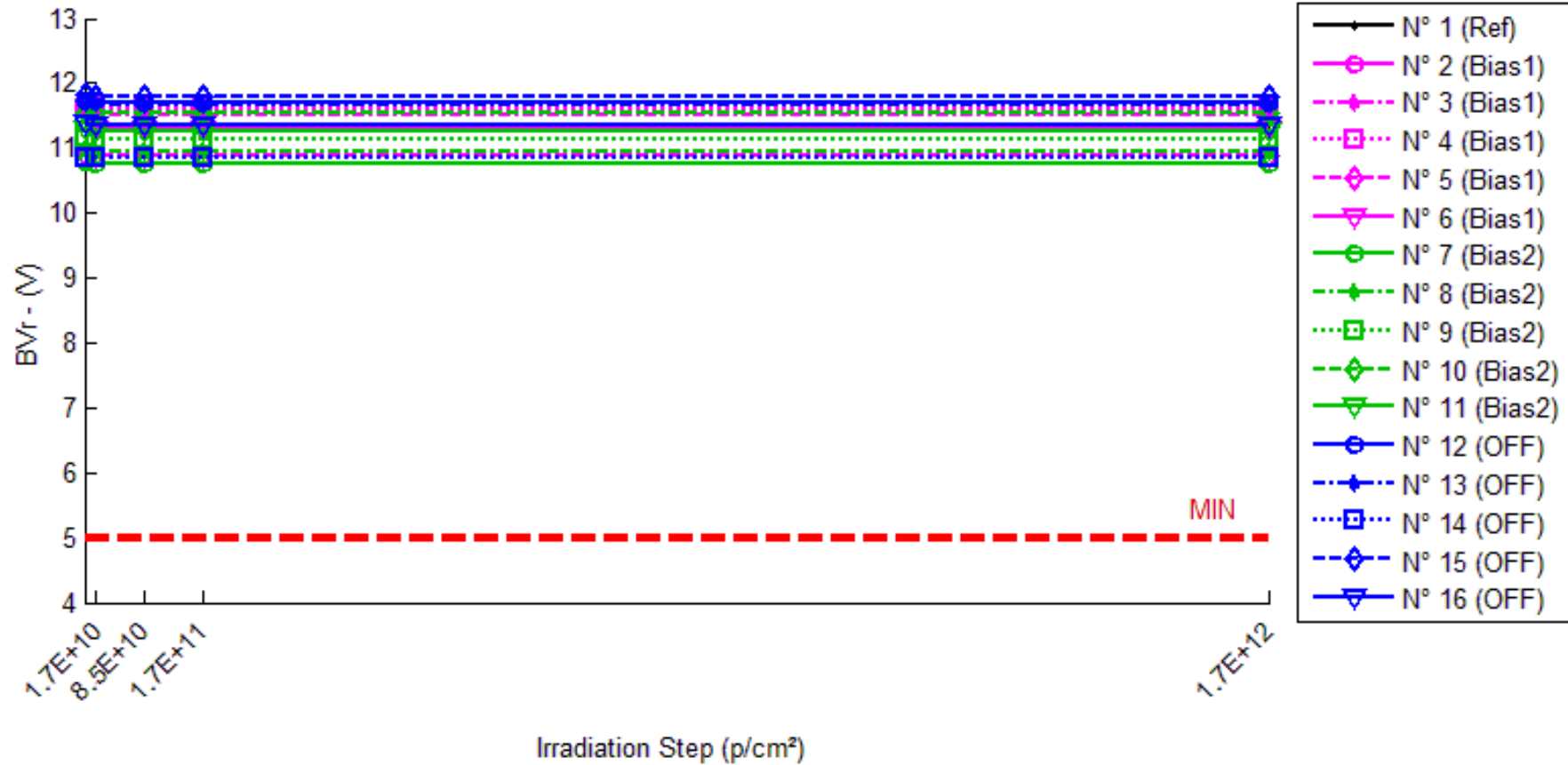

30 MeV proton / detailed results

BVr . (V)

Min = 5.0

	0,p/cm ²	1.7E10.p/cm ²	8.5E10.p/cm ²	1.7E11.p/cm ²	1.7E12.p/cm ²
N° 1 (Ref)	11.278	11.269	11.272	11.273	11.270
N° 2 (Bias1)	11.700	11.690	11.703	11.701	11.686
N° 3 (Bias1)	11.519	11.511	11.522	11.515	11.499
N° 4 (Bias1)	11.618	11.611	11.620	11.609	11.591
N° 5 (Bias1)	10.886	10.876	10.886	10.882	10.868
N° 6 (Bias1)	11.304	11.298	11.304	11.304	11.286
N° 7 (Bias2)	10.780	10.763	10.765	10.757	10.772
N° 8 (Bias2)	10.962	10.944	10.942	10.939	10.939
N° 9 (Bias2)	11.153	11.137	11.134	11.133	11.137
N° 10 (Bias2)	11.557	11.540	11.537	11.545	11.555
N° 11 (Bias2)	11.283	11.259	11.264	11.258	11.269
N° 12 (OFF)	11.717	11.727	11.712	11.699	11.697
N° 13 (OFF)	11.686	11.685	11.681	11.669	11.669
N° 14 (OFF)	10.861	10.858	10.857	10.843	10.841
N° 15 (OFF)	11.814	11.806	11.808	11.791	11.782
N° 16 (OFF)	11.373	11.369	11.369	11.352	11.342

Delta [BVr]

	0,p/cm ²	1.7E10.p/cm ²	8.5E10.p/cm ²	1.7E11.p/cm ²	1.7E12.p/cm ²
N° 1 (Ref)	---	-8.610E-3	-5.520E-3	-4.970E-3	-7.800E-3
N° 2 (Bias1)	---	-1.005E-2	2.930E-3	1.080E-3	-1.350E-2
N° 3 (Bias1)	---	-8.770E-3	2.520E-3	-4.440E-3	-2.047E-2
N° 4 (Bias1)	---	-6.750E-3	2.480E-3	-9.200E-3	-2.672E-2
N° 5 (Bias1)	---	-1.064E-2	-3.500E-4	-4.550E-3	-1.819E-2
N° 6 (Bias1)	---	-5.950E-3	-1.900E-4	-1.500E-4	-1.802E-2
N° 7 (Bias2)	---	-1.750E-2	-1.468E-2	-2.329E-2	-7.780E-3
N° 8 (Bias2)	---	-1.821E-2	-2.005E-2	-2.360E-2	-2.304E-2
N° 9 (Bias2)	---	-1.559E-2	-1.817E-2	-1.973E-2	-1.591E-2
N° 10 (Bias2)	---	-1.727E-2	-2.055E-2	-1.240E-2	-2.390E-3
N° 11 (Bias2)	---	-2.430E-2	-1.895E-2	-2.511E-2	-1.415E-2
N° 12 (OFF)	---	1.034E-2	-4.780E-3	-1.762E-2	-2.033E-2
N° 13 (OFF)	---	-1.540E-3	-5.220E-3	-1.706E-2	-1.773E-2
N° 14 (OFF)	---	-3.340E-3	-4.230E-3	-1.823E-2	-2.016E-2
N° 15 (OFF)	---	-7.940E-3	-6.420E-3	-2.249E-2	-3.243E-2
N° 16 (OFF)	---	-3.720E-3	-3.520E-3	-2.047E-2	-3.053E-2
Average (OFF)	---	-8.432E-3	1.478E-3	-3.452E-3	-1.938E-2
σ (OFF)	---	2.037E-3	1.606E-3	4.082E-3	4.819E-3
Average+3σ (OFF)	---	-2.321E-3	6.297E-3	8.795E-3	-4.922E-3
Average-3σ (OFF)	---	-1.454E-2	-3.341E-3	-1.570E-2	-3.384E-2
Average (Bias1)	---	-1.857E-2	-1.848E-2	-2.083E-2	-1.265E-2
σ (Bias1)	---	3.342E-3	2.319E-3	5.107E-3	7.903E-3
Average+3σ (Bias1)	---	-8.548E-3	-1.152E-2	-5.506E-3	1.105E-2
Average-3σ (Bias1)	---	-2.860E-2	-2.544E-2	-3.615E-2	-3.636E-2
Average (Bias2)	---	-1.240E-3	-4.834E-3	-1.917E-2	-2.424E-2
σ (Bias2)	---	6.885E-3	1.091E-3	2.261E-3	6.726E-3
Average+3σ (Bias2)	---	1.942E-2	-1.562E-3	-1.239E-2	-4.058E-3
Average-3σ (Bias2)	---	-2.190E-2	-8.106E-3	-2.596E-2	-4.441E-2

30 MeV proton / detailed results

5. ICCH

Ta=25°C; Vcc=18V; If=0

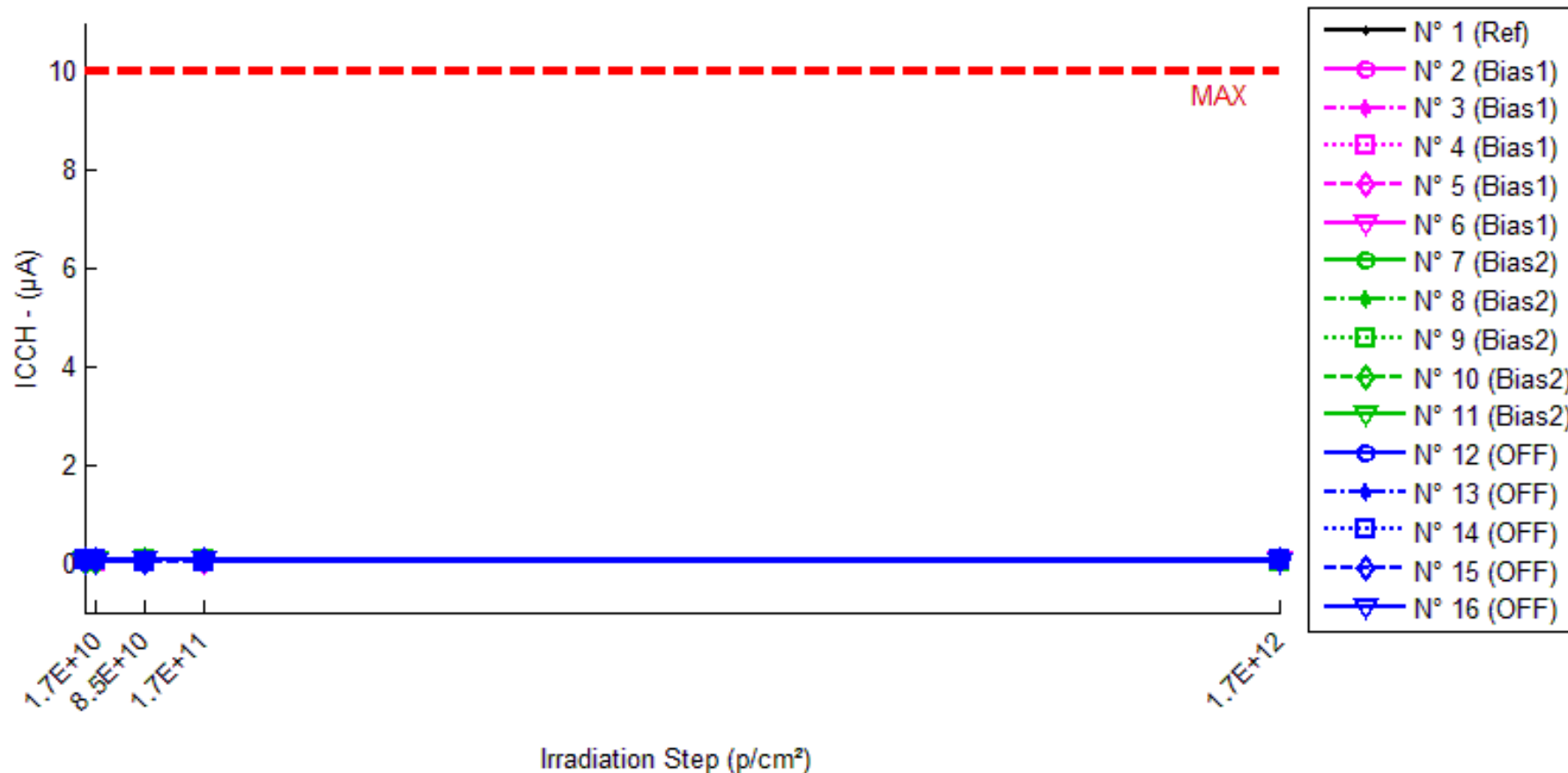

30 MeV proton / detailed results

ICCH. (μA)

Max = 10.0

	0.p/cm ²	1.7E10.p/cm ²	8.5E10.p/cm ²	1.7E11.p/cm ²	1.7E12.p/cm ²
N° 1 (Ref)	0.045	0.050	0.053	0.051	0.047
N° 2 (Bias1)	0.052	0.053	0.048	0.049	0.052
N° 3 (Bias1)	0.049	0.048	0.053	0.047	0.052
N° 4 (Bias1)	0.046	0.044	0.054	0.047	0.049
N° 5 (Bias1)	0.059	0.046	0.042	0.041	0.052
N° 6 (Bias1)	0.039	0.044	0.047	0.046	0.047
N° 7 (Bias2)	0.050	0.043	0.052	0.052	0.047
N° 8 (Bias2)	0.049	0.053	0.053	0.049	0.048
N° 9 (Bias2)	0.046	0.051	0.051	0.050	0.043
N° 10 (Bias2)	0.045	0.044	0.046	0.047	0.051
N° 11 (Bias2)	0.049	0.050	0.049	0.051	0.044
N° 12 (OFF)	0.045	0.051	0.053	0.050	0.046
N° 13 (OFF)	0.055	0.047	0.047	0.048	0.058
N° 14 (OFF)	0.047	0.052	0.044	0.043	0.047
N° 15 (OFF)	0.051	0.049	0.041	0.046	0.047
N° 16 (OFF)	0.039	0.042	0.049	0.054	0.044

Delta [ICCH]

	0.p/cm ²	1.7E10.p/cm ²	8.5E10.p/cm ²	1.7E11.p/cm ²	1.7E12.p/cm ²
N° 1 (Ref)	---	4.930E-3	7.950E-3	5.650E-3	2.120E-3
N° 2 (Bias1)	---	4.700E-4	-4.390E-3	-3.060E-3	4.000E-5
N° 3 (Bias1)	---	-1.540E-3	4.290E-3	-2.320E-3	3.140E-3
N° 4 (Bias1)	---	-2.710E-3	7.680E-3	3.500E-4	3.060E-3
N° 5 (Bias1)	---	-1.270E-2	-1.650E-2	-1.726E-2	-6.870E-3
N° 6 (Bias1)	---	5.590E-3	8.580E-3	7.660E-3	8.130E-3
N° 7 (Bias2)	---	-6.440E-3	2.900E-3	2.080E-3	-2.520E-3
N° 8 (Bias2)	---	3.940E-3	3.630E-3	-3.500E-4	-8.800E-4
N° 9 (Bias2)	---	5.280E-3	5.050E-3	4.640E-3	-2.660E-3
N° 10 (Bias2)	---	-1.110E-3	8.200E-4	2.360E-3	5.710E-3
N° 11 (Bias2)	---	9.200E-4	6.000E-5	2.650E-3	-4.310E-3
N° 12 (OFF)	---	5.870E-3	7.290E-3	5.260E-3	1.110E-3
N° 13 (OFF)	---	-7.650E-3	-7.820E-3	-6.100E-3	3.710E-3
N° 14 (OFF)	---	5.520E-3	-2.960E-3	-3.860E-3	4.700E-4
N° 15 (OFF)	---	-2.150E-3	-1.004E-2	-4.740E-3	-4.210E-3
N° 16 (OFF)	---	3.230E-3	1.033E-2	1.505E-2	5.480E-3
Average (OFF)	---	-2.178E-3	-6.800E-5	-2.926E-3	1.500E-3
σ (OFF)	---	6.685E-3	1.052E-2	9.064E-3	5.506E-3
Average+3 σ (OFF)	---	1.788E-2	3.149E-2	2.427E-2	1.802E-2
Average-3 σ (OFF)	---	-2.223E-2	-3.162E-2	-3.012E-2	-1.502E-2
Average (Bias1)	---	5.180E-4	2.492E-3	2.276E-3	-9.320E-4
σ (Bias1)	---	4.626E-3	2.044E-3	1.780E-3	3.906E-3
Average+3 σ (Bias1)	---	1.440E-2	8.625E-3	7.615E-3	1.079E-2
Average-3 σ (Bias1)	---	-1.336E-2	-3.641E-3	-3.063E-3	-1.265E-2
Average (Bias2)	---	9.640E-4	-6.400E-4	1.122E-3	1.312E-3
σ (Bias2)	---	5.785E-3	9.063E-3	8.978E-3	3.687E-3
Average+3 σ (Bias2)	---	1.832E-2	2.655E-2	2.806E-2	1.237E-2
Average-3 σ (Bias2)	---	-1.639E-2	-2.783E-2	-2.581E-2	-9.748E-3

30 MeV proton / detailed results

6. ICCL

Ta=25°C; Vcc=18V; If=20mA

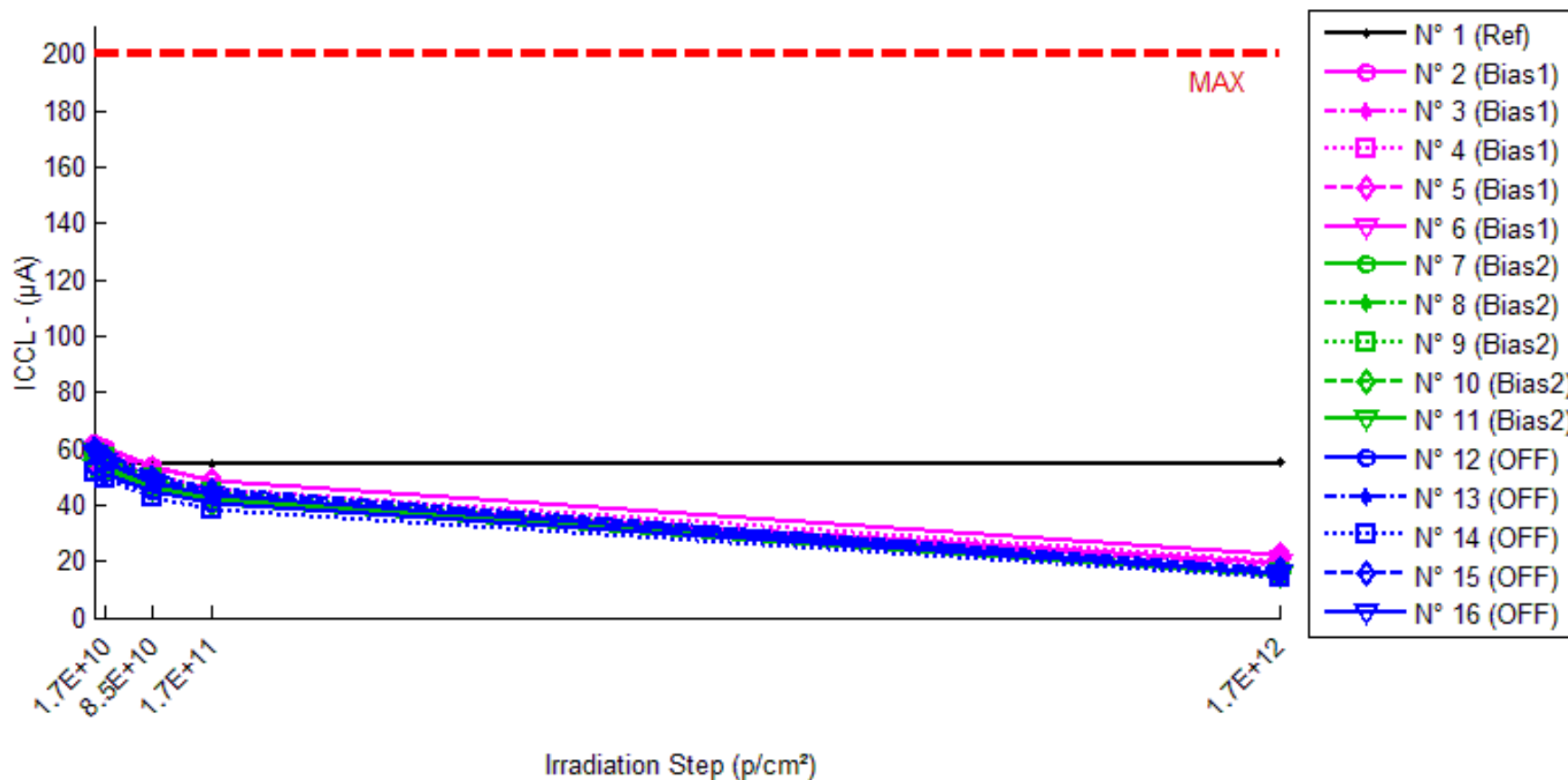

30 MeV proton / detailed results

ICCL . (µA)

Max = 200.0

	0,p/cm ²	1.7E10.p/cm ²	8.5E10.p/cm ²	1.7E11.p/cm ²	1.7E12.p/cm ²
N° 1 (Ref)	54.647	54.976	54.718	54.877	55.011
N° 2 (Bias1)	61.944	60.137	53.568	48.612	21.956
N° 3 (Bias1)	53.462	51.971	46.525	42.295	18.930
N° 4 (Bias1)	58.788	57.007	50.650	46.041	20.191
N° 5 (Bias1)	60.672	59.131	53.105	48.507	22.273
N° 6 (Bias1)	54.611	52.884	47.453	42.932	19.160
N° 7 (Bias2)	53.698	52.950	47.116	42.020	15.950
N° 8 (Bias2)	56.749	55.559	48.626	43.465	15.946
N° 9 (Bias2)	58.328	56.837	49.507	44.090	15.802
N° 10 (Bias2)	52.910	51.958	45.832	40.675	15.532
N° 11 (Bias2)	53.304	52.349	45.476	40.762	14.919
N° 12 (OFF)	53.761	50.871	45.094	40.627	15.551
N° 13 (OFF)	61.154	58.264	50.719	45.377	16.768
N° 14 (OFF)	51.652	49.372	43.048	38.473	14.313
N° 15 (OFF)	59.272	56.886	49.712	44.859	16.904
N° 16 (OFF)	57.869	55.235	48.072	43.469	15.920

Delta [ICCL]

	0,p/cm ²	1.7E10.p/cm ²	8.5E10.p/cm ²	1.7E11.p/cm ²	1.7E12.p/cm ²
N° 1 (Ref)	---	3.292E-1	7.160E-2	2.308E-1	3.646E-1
N° 2 (Bias1)	---	-1.808E+0	-8.376E+0	-1.333E+1	-3.999E+1
N° 3 (Bias1)	---	-1.491E+0	-6.936E+0	-1.117E+1	-3.453E+1
N° 4 (Bias1)	---	-1.781E+0	-8.138E+0	-1.275E+1	-3.860E+1
N° 5 (Bias1)	---	-1.541E+0	-7.567E+0	-1.217E+1	-3.840E+1
N° 6 (Bias1)	---	-1.727E+0	-7.157E+0	-1.168E+1	-3.545E+1
N° 7 (Bias2)	---	-7.483E-1	-6.582E+0	-1.168E+1	-3.775E+1
N° 8 (Bias2)	---	-1.191E+0	-8.123E+0	-1.328E+1	-4.080E+1
N° 9 (Bias2)	---	-1.491E+0	-8.821E+0	-1.424E+1	-4.253E+1
N° 10 (Bias2)	---	-9.511E-1	-7.078E+0	-1.223E+1	-3.738E+1
N° 11 (Bias2)	---	-9.545E-1	-7.828E+0	-1.254E+1	-3.838E+1
N° 12 (OFF)	---	-2.890E+0	-8.667E+0	-1.313E+1	-3.821E+1
N° 13 (OFF)	---	-2.890E+0	-1.044E+1	-1.578E+1	-4.439E+1
N° 14 (OFF)	---	-2.280E+0	-8.604E+0	-1.318E+1	-3.734E+1
N° 15 (OFF)	---	-2.386E+0	-9.560E+0	-1.441E+1	-4.237E+1
N° 16 (OFF)	---	-2.633E+0	-9.796E+0	-1.440E+1	-4.195E+1
Average (OFF)	---	-1.669E+0	-7.635E+0	-1.222E+1	-3.739E+1
σ (OFF)	---	1.444E-1	6.170E-1	8.546E-1	2.300E+0
Average+3σ (OFF)	---	-1.236E+0	-5.784E+0	-9.654E+0	-3.049E+1
Average-3σ (OFF)	---	-2.103E+0	-9.486E+0	-1.478E+1	-4.429E+1
Average (Bias1)	---	-1.067E+0	-7.686E+0	-1.280E+1	-3.937E+1
σ (Bias1)	---	2.841E-1	8.788E-1	9.937E-1	2.213E+0
Average+3σ (Bias1)	---	-2.148E-1	-5.050E+0	-9.814E+0	-3.273E+1
Average-3σ (Bias1)	---	-1.919E+0	-1.032E+1	-1.578E+1	-4.601E+1
Average (Bias2)	---	-2.616E+0	-9.413E+0	-1.418E+1	-4.085E+1
σ (Bias2)	---	2.811E-1	7.785E-1	1.089E+0	2.971E+0
Average+3σ (Bias2)	---	-1.772E+0	-7.077E+0	-1.091E+1	-3.194E+1
Average-3σ (Bias2)	---	-3.459E+0	-1.175E+1	-1.745E+1	-4.976E+1

30 MeV proton / detailed results

7. TPLH

Ta=25°C; RL=8.2 kOhms; Cl=50pF; If=16mA; Vcc=5V

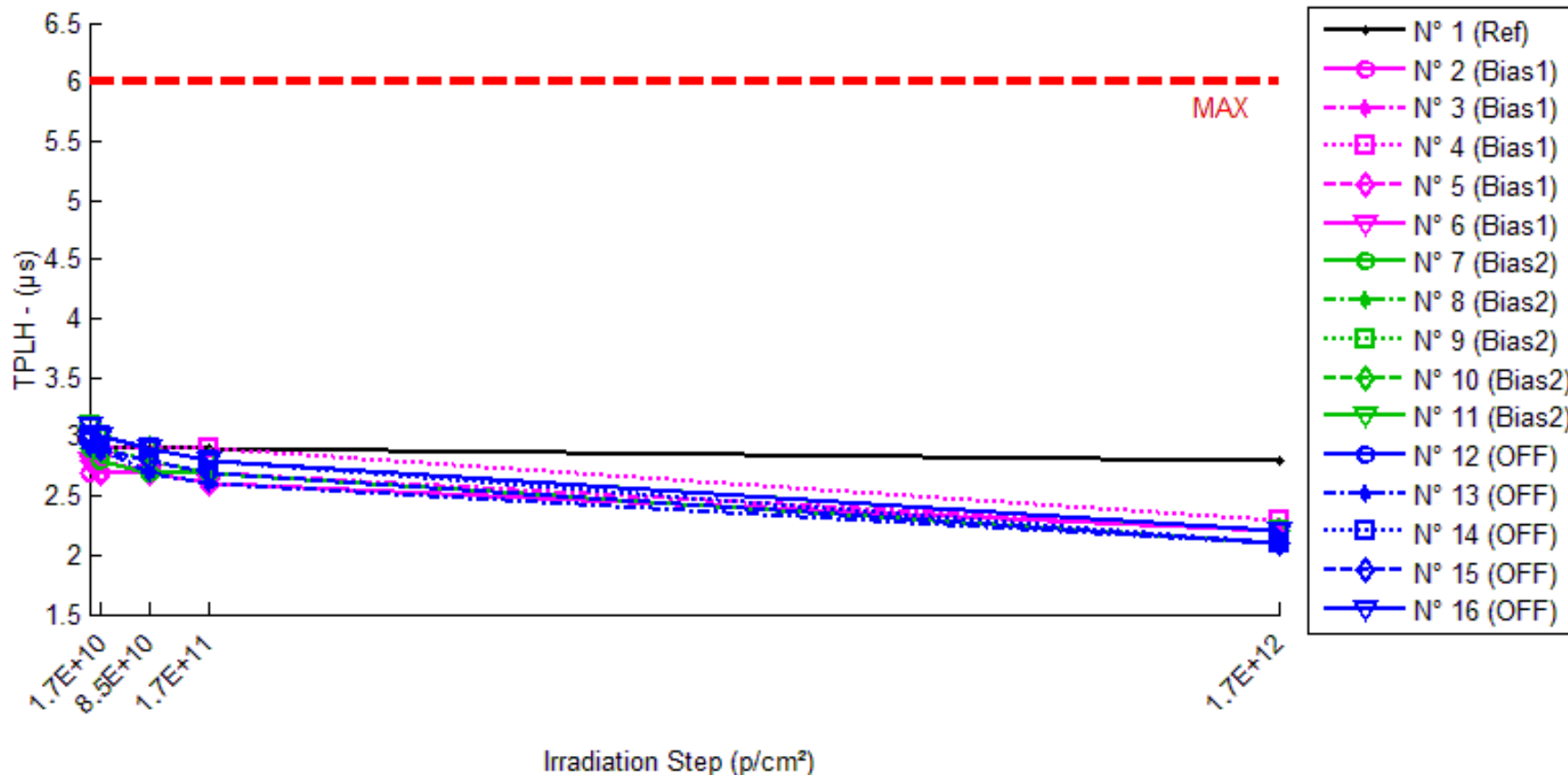

30 MeV proton / detailed results

TPH . (µs) Max = 6.0

	0.p/cm ²	1.7E10.p/cm ²	8.5E10.p/cm ²	1.7E11.p/cm ²	1.7E12.p/cm ²
N° 1 (Ref)	2.9	2.9	2.9	2.9	2.8
N° 2 (Bias1)	2.7	2.7	2.7	2.6	2.2
N° 3 (Bias1)	2.8	2.8	2.7	2.7	2.2
N° 4 (Bias1)	3.0	2.9	2.9	2.9	2.3
N° 5 (Bias1)	2.8	2.7	2.7	2.6	2.2
N° 6 (Bias1)	2.8	2.8	2.7	2.6	2.2
N° 7 (Bias2)	2.9	2.8	2.7	2.7	2.1
N° 8 (Bias2)	2.9	2.9	2.8	2.7	2.1
N° 9 (Bias2)	3.1	3.0	2.9	2.8	2.2
N° 10 (Bias2)	3.0	3.0	2.9	2.8	2.2
N° 11 (Bias2)	3.0	3.0	2.9	2.8	2.2
N° 12 (OFF)	3.0	3.0	2.9	2.8	2.2
N° 13 (OFF)	2.9	2.9	2.7	2.6	2.1
N° 14 (OFF)	3.0	3.0	2.9	2.8	2.1
N° 15 (OFF)	3.0	2.9	2.8	2.7	2.1
N° 16 (OFF)	3.1	3.0	2.9	2.8	2.2

Delta [TPH]

	0.p/cm ²	1.7E10.p/cm ²	8.5E10.p/cm ²	1.7E11.p/cm ²	1.7E12.p/cm ²
N° 1 (Ref)	---	0.000E+0	0.000E+0	0.000E+0	-1.000E-1
N° 2 (Bias1)	---	0.000E+0	0.000E+0	-1.000E-1	-5.000E-1
N° 3 (Bias1)	---	0.000E+0	-1.000E-1	-1.000E-1	-6.000E-1
N° 4 (Bias1)	---	-1.000E-1	-1.000E-1	-1.500E-1	-7.000E-1
N° 5 (Bias1)	---	-5.000E-2	-5.000E-2	-1.500E-1	-5.500E-1
N° 6 (Bias1)	---	-5.000E-2	-1.000E-1	-1.500E-1	-6.000E-1
N° 7 (Bias2)	---	-1.000E-1	-2.000E-1	-2.000E-1	-7.500E-1
N° 8 (Bias2)	---	0.000E+0	-1.000E-1	-2.000E-1	-8.000E-1
N° 9 (Bias2)	---	-1.000E-1	-2.000E-1	-3.000E-1	-9.000E-1
N° 10 (Bias2)	---	0.000E+0	-1.000E-1	-2.000E-1	-8.000E-1
N° 11 (Bias2)	---	-5.000E-2	-1.000E-1	-2.000E-1	-8.000E-1
N° 12 (OFF)	---	0.000E+0	-1.000E-1	-2.000E-1	-8.000E-1
N° 13 (OFF)	---	-5.000E-2	-2.000E-1	-3.000E-1	-8.000E-1
N° 14 (OFF)	---	-5.000E-2	-1.500E-1	-2.500E-1	-9.000E-1
N° 15 (OFF)	---	-1.000E-1	-2.000E-1	-3.000E-1	-9.000E-1
N° 16 (OFF)	---	-1.000E-1	-2.000E-1	-3.000E-1	-9.000E-1
Average (OFF)	---	-4.000E-2	-7.000E-2	-1.300E-1	-5.900E-1
σ (OFF)	---	4.183E-2	4.472E-2	2.739E-2	7.416E-2
Average+3σ (OFF)	---	8.550E-2	6.416E-2	-4.784E-2	-3.675E-1
Average-3σ (OFF)	---	-1.655E-1	-2.042E-1	-2.122E-1	-8.125E-1
Average (Bias1)	---	-5.000E-2	-1.400E-1	-2.200E-1	-8.100E-1
σ (Bias1)	---	5.000E-2	5.477E-2	4.472E-2	5.477E-2
Average+3σ (Bias1)	---	1.000E-1	2.432E-2	-8.584E-2	-6.457E-1
Average-3σ (Bias1)	---	-2.000E-1	-3.043E-1	-3.542E-1	-9.743E-1
Average (Bias2)	---	-6.000E-2	-1.700E-1	-2.700E-1	-8.600E-1
σ (Bias2)	---	4.183E-2	4.472E-2	4.472E-2	5.477E-2
Average+3σ (Bias2)	---	6.550E-2	-3.584E-2	-1.358E-1	-6.957E-1
Average-3σ (Bias2)	---	-1.855E-1	-3.042E-1	-4.042E-1	-1.024E+0

30 MeV proton / detailed results

8. TPHL

Ta=25°C; RL=8.2 kOhms; Cl=50pF; If=16mA; Vcc=5V

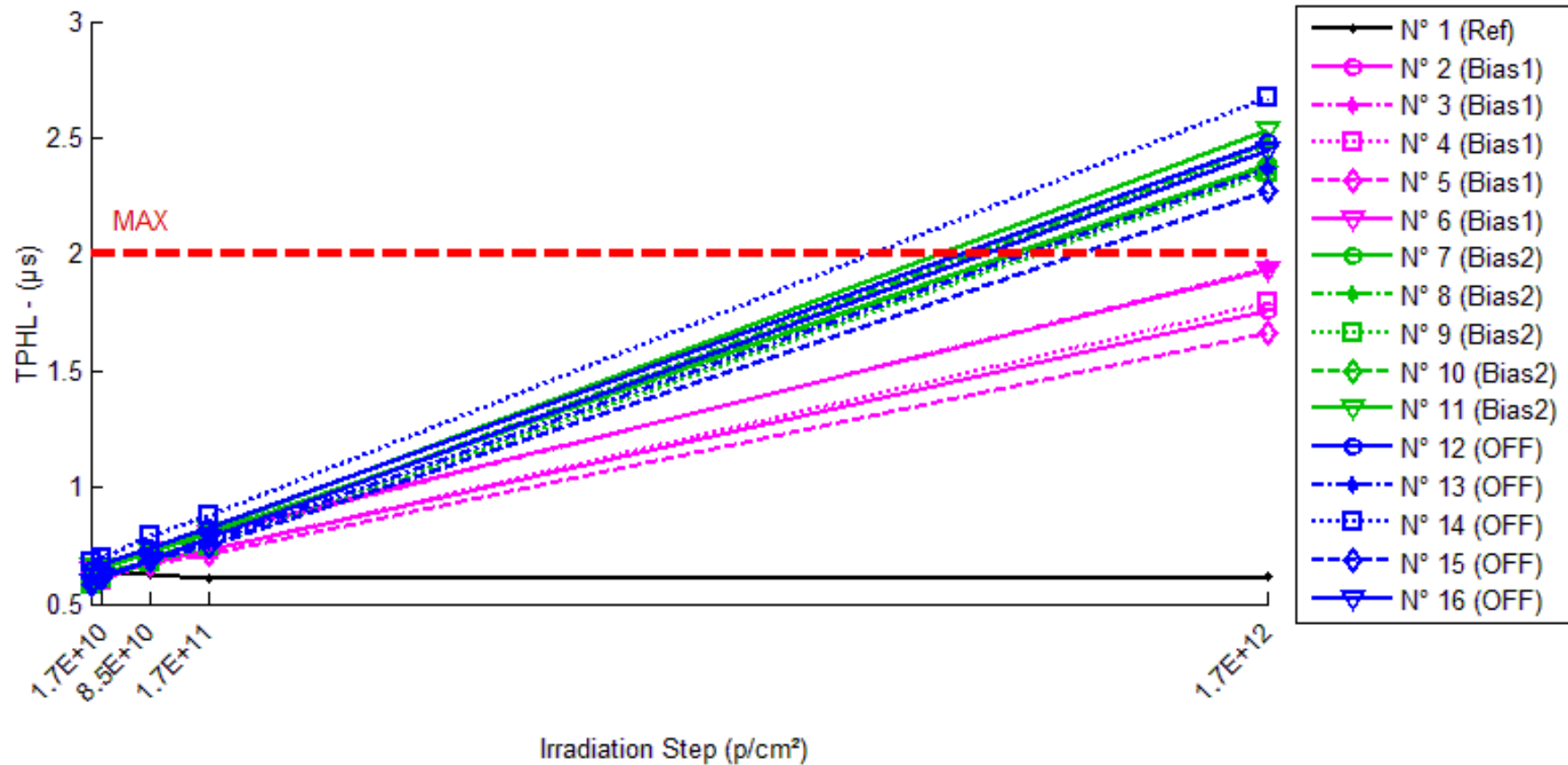

30 MeV proton / detailed results

TPHL . (µs)

Max = 2.0

	0,p/cm ²	1.7E10.p/cm ²	8.5E10.p/cm ²	1.7E11.p/cm ²	1.7E12.p/cm ²
N° 1 (Ref)	0.64	0.63	0.63	0.61	0.62
N° 2 (Bias1)	0.60	0.61	0.68	0.73	1.76
N° 3 (Bias1)	0.64	0.67	0.74	0.79	1.94
N° 4 (Bias1)	0.59	0.60	0.69	0.73	1.79
N° 5 (Bias1)	0.59	0.61	0.67	0.71	1.66
N° 6 (Bias1)	0.64	0.66	0.73	0.80	1.93
N° 7 (Bias2)	0.63	0.65	0.72	0.80	2.39
N° 8 (Bias2)	0.60	0.63	0.70	0.78	2.47
N° 9 (Bias2)	0.58	0.61	0.68	0.75	2.35
N° 10 (Bias2)	0.65	0.65	0.72	0.80	2.38
N° 11 (Bias2)	0.66	0.66	0.72	0.82	2.53
N° 12 (OFF)	0.64	0.67	0.74	0.83	2.48
N° 13 (OFF)	0.60	0.61	0.69	0.77	2.37
N° 14 (OFF)	0.68	0.70	0.79	0.88	2.67
N° 15 (OFF)	0.58	0.61	0.69	0.75	2.27
N° 16 (OFF)	0.59	0.62	0.69	0.78	2.45

Delta [TPHL]

	0,p/cm ²	1.7E10.p/cm ²	8.5E10.p/cm ²	1.7E11.p/cm ²	1.7E12.p/cm ²
N° 1 (Ref)	---	-1.000E-2	-1.000E-2	-3.000E-2	-2.000E-2
N° 2 (Bias1)	---	1.000E-2	8.000E-2	1.300E-1	1.160E+0
N° 3 (Bias1)	---	3.000E-2	1.000E-1	1.500E-1	1.300E+0
N° 4 (Bias1)	---	1.000E-2	1.000E-1	1.400E-1	1.200E+0
N° 5 (Bias1)	---	2.000E-2	8.000E-2	1.200E-1	1.070E+0
N° 6 (Bias1)	---	2.000E-2	9.000E-2	1.600E-1	1.290E+0
N° 7 (Bias2)	---	2.000E-2	9.000E-2	1.700E-1	1.760E+0
N° 8 (Bias2)	---	3.000E-2	1.000E-1	1.800E-1	1.870E+0
N° 9 (Bias2)	---	3.000E-2	1.000E-1	1.700E-1	1.770E+0
N° 10 (Bias2)	---	0.000E+0	7.000E-2	1.500E-1	1.730E+0
N° 11 (Bias2)	---	0.000E+0	6.000E-2	1.600E-1	1.870E+0
N° 12 (OFF)	---	3.000E-2	1.000E-1	1.900E-1	1.840E+0
N° 13 (OFF)	---	1.000E-2	9.000E-2	1.700E-1	1.770E+0
N° 14 (OFF)	---	2.000E-2	1.100E-1	2.000E-1	1.990E+0
N° 15 (OFF)	---	3.000E-2	1.100E-1	1.700E-1	1.690E+0
N° 16 (OFF)	---	3.000E-2	1.000E-1	1.900E-1	1.860E+0
Average (OFF)	---	1.800E-2	9.000E-2	1.400E-1	1.204E+0
σ (OFF)	---	8.367E-3	1.000E-2	1.581E-2	9.555E-2
Average+3σ (OFF)	---	4.310E-2	1.200E-1	1.874E-1	1.491E+0
Average-3σ (OFF)	---	-7.100E-3	6.000E-2	9.257E-2	9.173E-1
Average (Bias1)	---	1.600E-2	8.400E-2	1.660E-1	1.800E+0
σ (Bias1)	---	1.517E-2	1.817E-2	1.140E-2	6.557E-2
Average+3σ (Bias1)	---	6.150E-2	1.385E-1	2.002E-1	1.997E+0
Average-3σ (Bias1)	---	-2.950E-2	2.950E-2	1.318E-1	1.603E+0
Average (Bias2)	---	2.400E-2	1.020E-1	1.840E-1	1.830E+0
σ (Bias2)	---	8.944E-3	8.367E-3	1.342E-2	1.116E-1
Average+3σ (Bias2)	---	5.083E-2	1.271E-1	2.242E-1	2.165E+0
Average-3σ (Bias2)	---	-2.833E-3	7.690E-2	1.438E-1	1.495E+0

30 MeV proton / detailed results

9. CTR1

Ta=25°C; Vo=0.4V; If=2mA; Vcc=5V

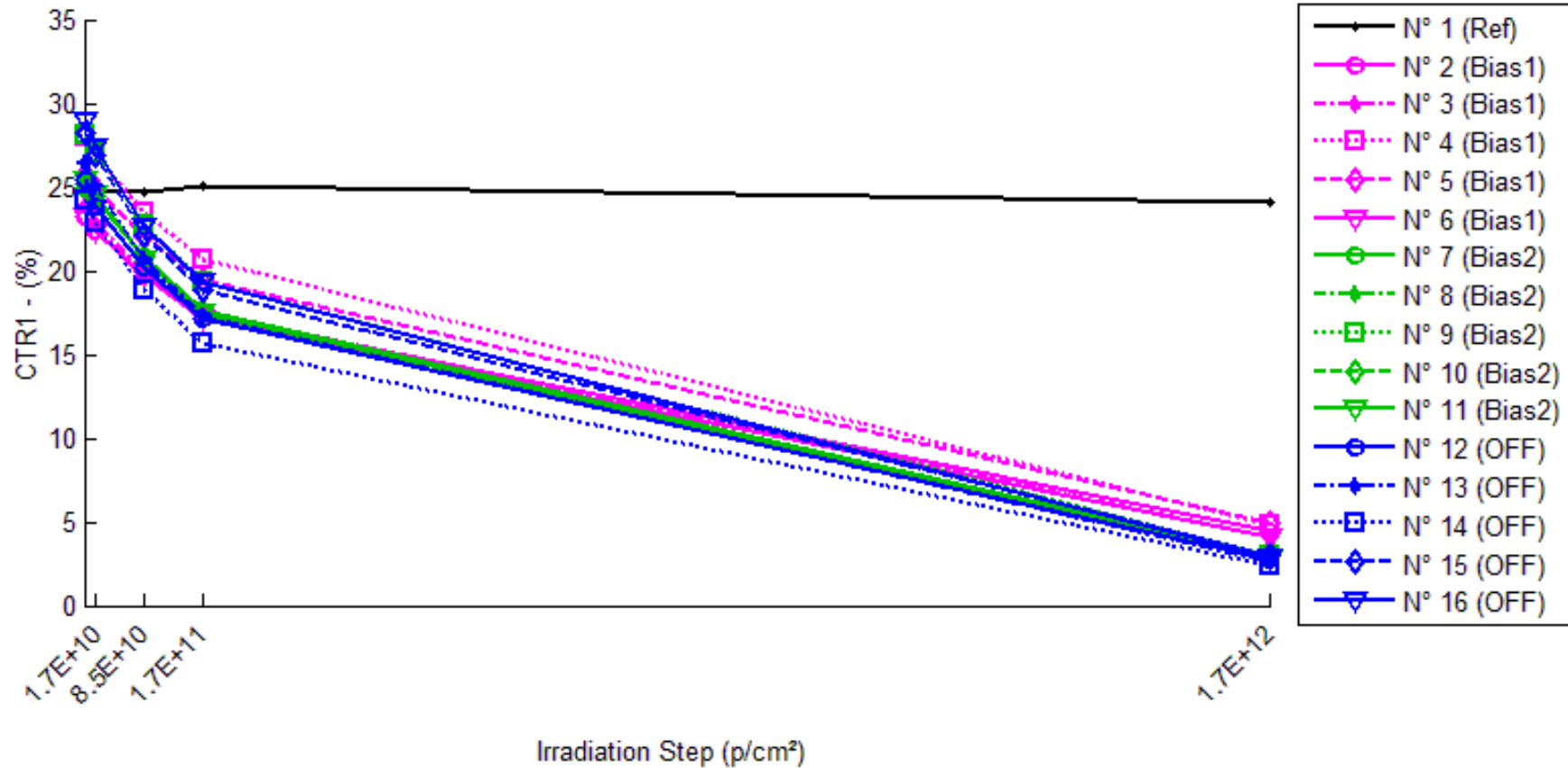

30 MeV proton / detailed results

CTR1 . (%)

	0.p/cm ²	1.7E10.p/cm ²	8.5E10.p/cm ²	1.7E11.p/cm ²	1.7E12.p/cm ²
N° 1 (Ref)	24.84	24.84	24.71	25.07	24.05
N° 2 (Bias1)	23.23	22.36	19.75	17.32	4.43
N° 3 (Bias1)	23.83	22.87	19.98	17.44	4.09
N° 4 (Bias1)	28.00	26.91	23.52	20.72	4.84
N° 5 (Bias1)	25.83	24.97	22.01	19.40	4.96
N° 6 (Bias1)	23.29	22.36	19.73	17.09	4.04
N° 7 (Bias2)	24.97	24.35	20.79	17.58	3.02
N° 8 (Bias2)	25.46	24.56	20.74	17.29	2.70
N° 9 (Bias2)	28.13	27.05	22.80	19.33	3.03
N° 10 (Bias2)	25.21	24.43	20.81	17.48	2.98
N° 11 (Bias2)	25.38	24.57	20.63	17.44	2.73
N° 12 (OFF)	25.39	23.88	20.17	17.11	2.76
N° 13 (OFF)	26.42	25.01	20.63	17.30	2.66
N° 14 (OFF)	24.19	22.81	18.84	15.71	2.37
N° 15 (OFF)	28.21	26.91	22.16	18.79	2.96
N° 16 (OFF)	28.91	27.38	22.68	19.31	2.92

1/Delta [CTR1]

	0.p/cm ²	1.7E10.p/cm ²	8.5E10.p/cm ²	1.7E11.p/cm ²	1.7E12.p/cm ²
N° 1 (Ref)	---	5.657E-6	2.179E-4	-3.762E-4	1.331E-3
N° 2 (Bias1)	---	1.673E-3	7.580E-3	1.471E-2	1.827E-1
N° 3 (Bias1)	---	1.751E-3	8.074E-3	1.536E-2	2.023E-1
N° 4 (Bias1)	---	1.450E-3	6.793E-3	1.255E-2	1.710E-1
N° 5 (Bias1)	---	1.337E-3	6.720E-3	1.283E-2	1.629E-1
N° 6 (Bias1)	---	1.776E-3	7.733E-3	1.556E-2	2.048E-1
N° 7 (Bias2)	---	1.021E-3	8.063E-3	1.684E-2	2.916E-1
N° 8 (Bias2)	---	1.449E-3	8.942E-3	1.855E-2	3.314E-1
N° 9 (Bias2)	---	1.425E-3	8.302E-3	1.618E-2	2.941E-1
N° 10 (Bias2)	---	1.273E-3	8.395E-3	1.754E-2	2.962E-1
N° 11 (Bias2)	---	1.288E-3	9.062E-3	1.793E-2	3.264E-1
N° 12 (OFF)	---	2.486E-3	1.019E-2	1.906E-2	3.235E-1
N° 13 (OFF)	---	2.143E-3	1.063E-2	1.997E-2	3.384E-1
N° 14 (OFF)	---	2.502E-3	1.176E-2	2.234E-2	3.814E-1
N° 15 (OFF)	---	1.721E-3	9.678E-3	1.776E-2	3.026E-1
N° 16 (OFF)	---	1.927E-3	9.497E-3	1.720E-2	3.082E-1
Average (OFF)	---	1.598E-3	7.380E-3	1.420E-2	1.848E-1
σ (OFF)	---	1.940E-4	5.973E-4	1.421E-3	1.860E-2
Average+3 σ (OFF)	---	2.180E-3	9.172E-3	1.846E-2	2.406E-1
Average-3 σ (OFF)	---	1.015E-3	5.588E-3	9.938E-3	1.290E-1
Average (Bias1)	---	1.291E-3	8.553E-3	1.741E-2	3.079E-1
σ (Bias1)	---	1.703E-4	4.299E-4	9.259E-4	1.928E-2
Average+3 σ (Bias1)	---	1.802E-3	9.842E-3	2.019E-2	3.658E-1
Average-3 σ (Bias1)	---	7.804E-4	7.263E-3	1.463E-2	2.501E-1
Average (Bias2)	---	2.156E-3	1.035E-2	1.927E-2	3.309E-1
σ (Bias2)	---	3.430E-4	9.032E-4	2.032E-3	3.151E-2
Average+3 σ (Bias2)	---	3.185E-3	1.306E-2	2.536E-2	4.254E-1
Average-3 σ (Bias2)	---	1.127E-3	7.640E-3	1.317E-2	2.363E-1

30 MeV proton / detailed results

10.CTR2

Ta=25°C; Vo=0.4V; If=4mA; Vcc=5V

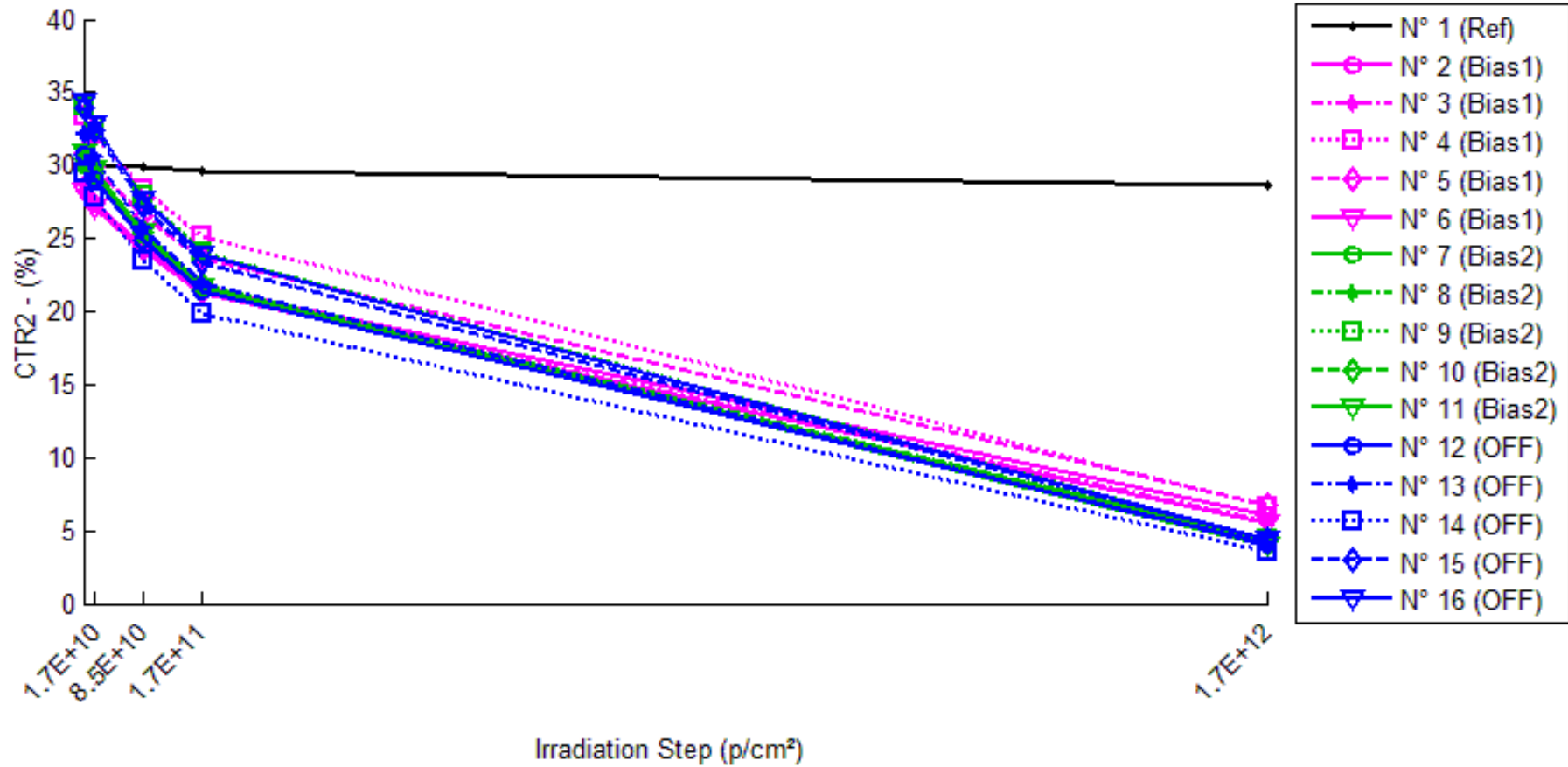

30 MeV proton / detailed results

CTR2 . (%)

	0.p/cm ²	1.7E10.p/cm ²	8.5E10.p/cm ²	1.7E11.p/cm ²	1.7E12.p/cm ²
N° 1 (Ref)	29.96	29.94	29.87	29.59	28.65
N° 2 (Bias1)	28.47	27.44	24.42	21.67	6.10
N° 3 (Bias1)	28.68	27.55	24.35	21.42	5.59
N° 4 (Bias1)	33.43	32.17	28.43	25.19	6.60
N° 5 (Bias1)	30.93	29.85	26.60	23.68	6.69
N° 6 (Bias1)	28.23	27.16	24.13	21.20	5.57
N° 7 (Bias2)	30.00	29.13	25.25	21.60	4.36
N° 8 (Bias2)	30.89	29.74	25.44	21.58	3.98
N° 9 (Bias2)	34.04	32.73	27.98	24.02	4.44
N° 10 (Bias2)	30.46	29.47	25.42	21.76	4.37
N° 11 (Bias2)	30.81	29.71	25.37	21.70	4.02
N° 12 (OFF)	30.67	29.10	24.92	21.37	4.13
N° 13 (OFF)	32.18	30.58	25.76	21.89	4.03
N° 14 (OFF)	29.42	27.86	23.50	19.85	3.58
N° 15 (OFF)	33.93	32.39	27.31	23.40	4.43
N° 16 (OFF)	34.40	32.76	27.72	23.85	4.34

1/Delta [CTR2]

	0.p/cm ²	1.7E10.p/cm ²	8.5E10.p/cm ²	1.7E11.p/cm ²	1.7E12.p/cm ²
N° 1 (Ref)	---	2.490E-5	1.029E-4	4.192E-4	1.523E-3
N° 2 (Bias1)	---	1.317E-3	5.827E-3	1.103E-2	1.288E-1
N° 3 (Bias1)	---	1.431E-3	6.201E-3	1.181E-2	1.440E-1
N° 4 (Bias1)	---	1.166E-3	5.256E-3	9.789E-3	1.217E-1
N° 5 (Bias1)	---	1.179E-3	5.263E-3	9.901E-3	1.171E-1
N° 6 (Bias1)	---	1.400E-3	6.028E-3	1.175E-2	1.441E-1
N° 7 (Bias2)	---	9.953E-4	6.271E-3	1.296E-2	1.960E-1
N° 8 (Bias2)	---	1.253E-3	6.942E-3	1.397E-2	2.188E-1
N° 9 (Bias2)	---	1.175E-3	6.363E-3	1.227E-2	1.959E-1
N° 10 (Bias2)	---	1.095E-3	6.502E-3	1.312E-2	1.958E-1
N° 11 (Bias2)	---	1.194E-3	6.953E-3	1.362E-2	2.161E-1
N° 12 (OFF)	---	1.759E-3	7.533E-3	1.419E-2	2.097E-1
N° 13 (OFF)	---	1.631E-3	7.751E-3	1.461E-2	2.172E-1
N° 14 (OFF)	---	1.896E-3	8.556E-3	1.638E-2	2.457E-1
N° 15 (OFF)	---	1.405E-3	7.141E-3	1.326E-2	1.963E-1
N° 16 (OFF)	---	1.458E-3	6.997E-3	1.285E-2	2.015E-1
Average (OFF)	---	1.298E-3	5.715E-3	1.086E-2	1.311E-1
σ (OFF)	---	1.225E-4	4.364E-4	9.725E-4	1.248E-2
Average+3 σ (OFF)	---	1.666E-3	7.024E-3	1.377E-2	1.686E-1
Average-3 σ (OFF)	---	9.311E-4	4.406E-3	7.938E-3	9.370E-2
Average (Bias1)	---	1.142E-3	6.606E-3	1.319E-2	2.045E-1
σ (Bias1)	---	9.974E-5	3.224E-4	6.534E-4	1.187E-2
Average+3 σ (Bias1)	---	1.441E-3	7.574E-3	1.515E-2	2.401E-1
Average-3 σ (Bias1)	---	8.430E-4	5.639E-3	1.123E-2	1.689E-1
Average (Bias2)	---	1.630E-3	7.596E-3	1.426E-2	2.141E-1
σ (Bias2)	---	2.046E-4	6.154E-4	1.380E-3	1.939E-2
Average+3 σ (Bias2)	---	2.244E-3	9.442E-3	1.840E-2	2.723E-1
Average-3 σ (Bias2)	---	1.016E-3	5.749E-3	1.012E-2	1.559E-1

30 MeV proton / detailed results

11.CTR3

Ta=25°C; Vo=0.4V; If=16mA; Vcc=4.5V

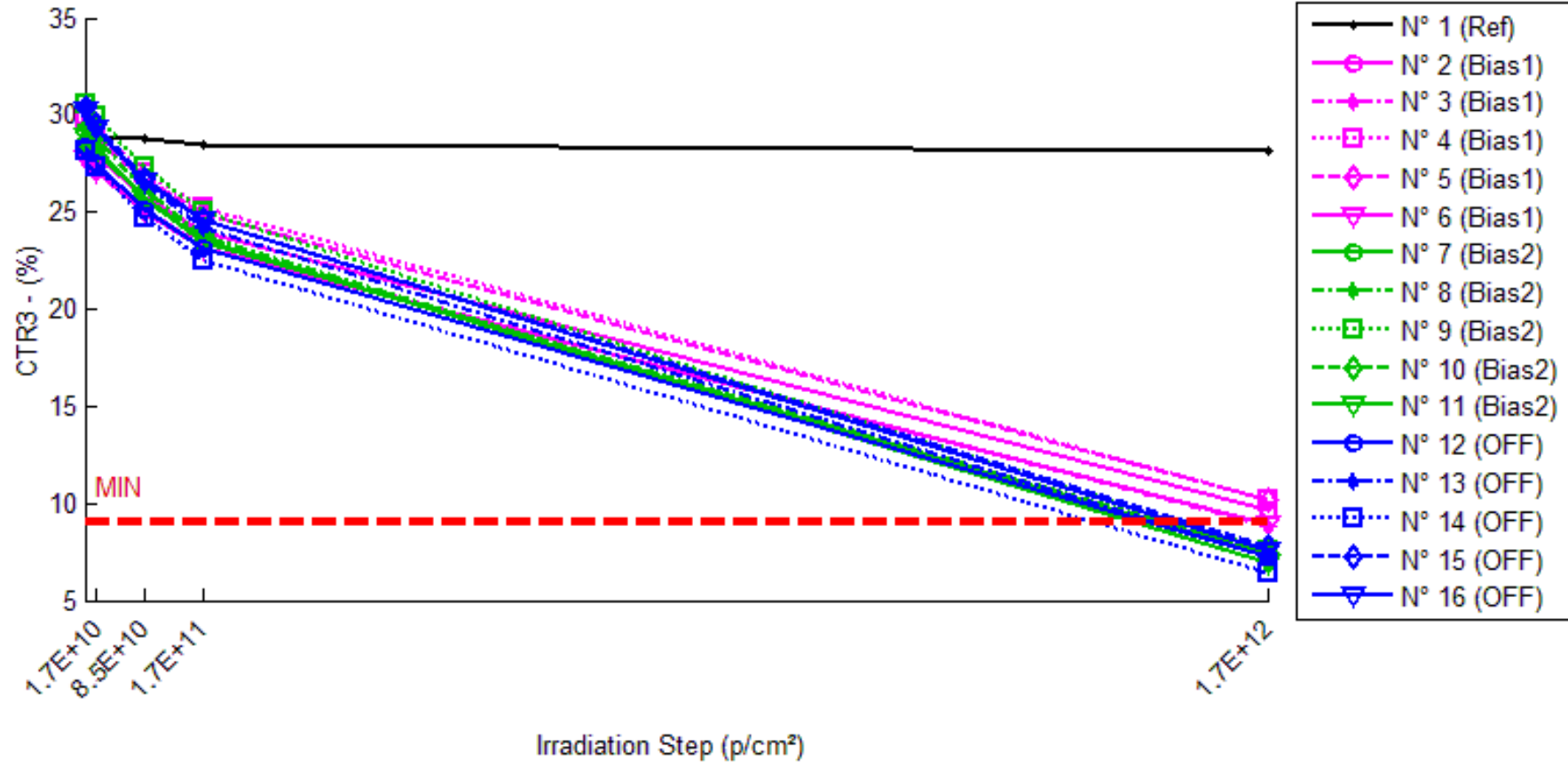

30 MeV proton / detailed results

CTR3 . (%)

Min = 9.0

	0.p/cm ²	1.7E10.p/cm ²	8.5E10.p/cm ²	1.7E11.p/cm ²	1.7E12.p/cm ²
N° 1 (Ref)	28.73	28.79	28.73	28.42	28.13
N° 2 (Bias1)	28.54	27.91	25.80	23.97	9.67
N° 3 (Bias1)	27.82	27.17	25.12	23.24	8.79
N° 4 (Bias1)	29.81	29.20	27.04	25.20	10.22
N° 5 (Bias1)	29.37	28.78	26.72	24.91	10.17
N° 6 (Bias1)	27.69	27.06	25.05	23.18	8.87
N° 7 (Bias2)	28.56	28.11	25.79	23.47	7.35
N° 8 (Bias2)	29.38	28.77	26.15	23.76	6.91
N° 9 (Bias2)	30.57	29.95	27.27	25.00	7.54
N° 10 (Bias2)	28.64	28.16	25.72	23.56	7.48
N° 11 (Bias2)	28.90	28.33	25.64	23.52	6.93
N° 12 (OFF)	28.41	27.57	25.14	23.14	7.24
N° 13 (OFF)	30.21	29.30	26.47	24.17	7.22
N° 14 (OFF)	28.15	27.32	24.67	22.49	6.38
N° 15 (OFF)	30.32	29.48	26.69	24.56	7.74
N° 16 (OFF)	30.20	29.35	26.58	24.63	7.53

1/Delta [CTR3]

	0.p/cm ²	1.7E10.p/cm ²	8.5E10.p/cm ²	1.7E11.p/cm ²	1.7E12.p/cm ²
N° 1 (Ref)	---	-6.699E-5	1.090E-7	3.777E-4	7.375E-4
N° 2 (Bias1)	---	7.854E-4	3.721E-3	6.677E-3	6.839E-2
N° 3 (Bias1)	---	8.661E-4	3.873E-3	7.089E-3	7.786E-2
N° 4 (Bias1)	---	7.100E-4	3.443E-3	6.143E-3	6.435E-2
N° 5 (Bias1)	---	6.993E-4	3.382E-3	6.089E-3	6.427E-2
N° 6 (Bias1)	---	8.380E-4	3.808E-3	7.022E-3	7.664E-2
N° 7 (Bias2)	---	5.565E-4	3.764E-3	7.582E-3	1.010E-1
N° 8 (Bias2)	---	7.212E-4	4.199E-3	8.051E-3	1.107E-1
N° 9 (Bias2)	---	6.743E-4	3.961E-3	7.281E-3	9.994E-2
N° 10 (Bias2)	---	5.961E-4	3.972E-3	7.533E-3	9.871E-2
N° 11 (Bias2)	---	6.922E-4	4.395E-3	7.913E-3	1.097E-1
N° 12 (OFF)	---	1.066E-3	4.577E-3	8.019E-3	1.029E-1
N° 13 (OFF)	---	1.032E-3	4.683E-3	8.275E-3	1.054E-1
N° 14 (OFF)	---	1.081E-3	5.011E-3	8.953E-3	1.213E-1
N° 15 (OFF)	---	9.355E-4	4.478E-3	7.736E-3	9.627E-2
N° 16 (OFF)	---	9.542E-4	4.510E-3	7.483E-3	9.973E-2
Average (OFF)	---	7.797E-4	3.645E-3	6.604E-3	7.030E-2
σ (OFF)	---	7.454E-5	2.205E-4	4.723E-4	6.571E-3
Average+3σ (OFF)	---	1.003E-3	4.307E-3	8.021E-3	9.002E-2
Average-3σ (OFF)	---	5.561E-4	2.984E-3	5.187E-3	5.059E-2
Average (Bias1)	---	6.481E-4	4.058E-3	7.672E-3	1.040E-1
σ (Bias1)	---	6.907E-5	2.432E-4	3.090E-4	5.719E-3
Average+3σ (Bias1)	---	8.553E-4	4.788E-3	8.599E-3	1.212E-1
Average-3σ (Bias1)	---	4.409E-4	3.329E-3	6.745E-3	8.685E-2
Average (Bias2)	---	1.014E-3	4.652E-3	8.093E-3	1.051E-1
σ (Bias2)	---	6.570E-5	2.157E-4	5.651E-4	9.656E-3
Average+3σ (Bias2)	---	1.211E-3	5.299E-3	9.788E-3	1.341E-1
Average-3σ (Bias2)	---	8.167E-4	4.005E-3	6.398E-3	7.615E-2

30 MeV proton / detailed results

12.CTR4

Ta=25°C; Vo=0.4V; If=20mA; Vcc=5V

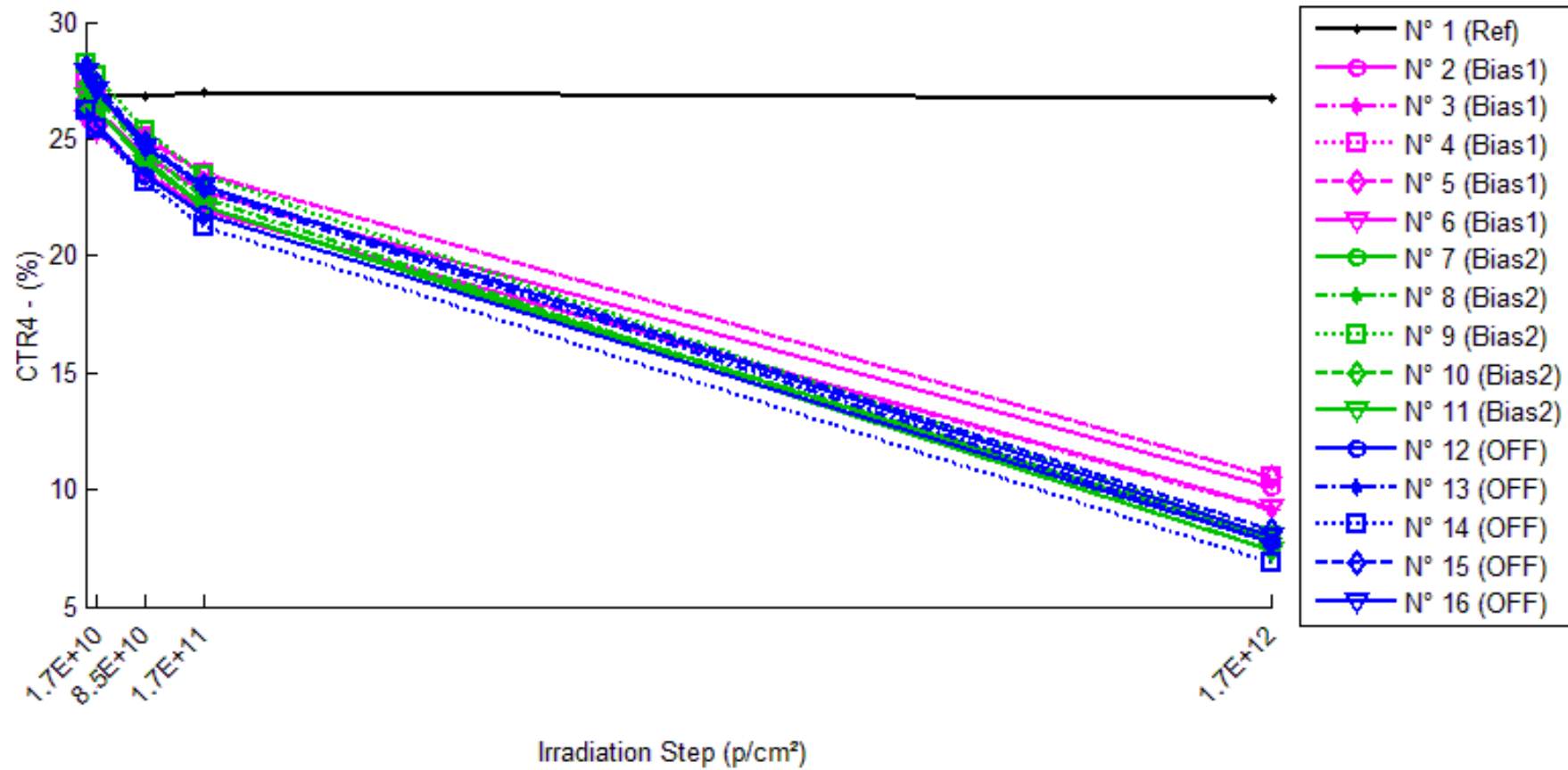

30 MeV proton / detailed results

CTR4 . (%)

	0.p/cm ²	1.7E10.p/cm ²	8.5E10.p/cm ²	1.7E11.p/cm ²	1.7E12.p/cm ²
N° 1 (Ref)	26.77	26.83	26.78	26.96	26.74
N° 2 (Bias1)	26.75	26.19	24.31	22.70	10.06
N° 3 (Bias1)	25.95	25.38	23.57	21.94	9.17
N° 4 (Bias1)	27.55	27.01	25.10	23.51	10.53
N° 5 (Bias1)	27.36	26.85	25.02	23.47	10.50
N° 6 (Bias1)	25.85	25.30	23.53	21.90	9.26
N° 7 (Bias2)	26.57	26.18	24.15	22.14	7.81
N° 8 (Bias2)	27.33	26.80	24.51	22.44	7.38
N° 9 (Bias2)	28.24	27.70	25.34	23.40	8.01
N° 10 (Bias2)	26.58	26.17	24.02	22.16	7.95
N° 11 (Bias2)	26.82	26.33	23.94	22.14	7.39
N° 12 (OFF)	26.33	25.60	23.45	21.75	7.72
N° 13 (OFF)	28.07	27.28	24.78	22.81	7.73
N° 14 (OFF)	26.17	25.45	23.12	21.27	6.83
N° 15 (OFF)	28.04	27.30	24.84	23.02	8.23
N° 16 (OFF)	27.86	27.12	24.65	23.03	8.01

1/Delta [CTR4]

	0.p/cm ²	1.7E10.p/cm ²	8.5E10.p/cm ²	1.7E11.p/cm ²	1.7E12.p/cm ²
N° 1 (Ref)	---	-8.005E-5	-8.160E-6	-2.653E-4	4.695E-5
N° 2 (Bias1)	---	7.901E-4	3.747E-3	6.657E-3	6.206E-2
N° 3 (Bias1)	---	8.620E-4	3.883E-3	7.045E-3	7.051E-2
N° 4 (Bias1)	---	7.206E-4	3.536E-3	6.234E-3	5.865E-2
N° 5 (Bias1)	---	6.978E-4	3.413E-3	6.063E-3	5.873E-2
N° 6 (Bias1)	---	8.446E-4	3.823E-3	6.982E-3	6.925E-2
N° 7 (Bias2)	---	5.563E-4	3.764E-3	7.522E-3	9.044E-2
N° 8 (Bias2)	---	7.277E-4	4.212E-3	7.983E-3	9.894E-2
N° 9 (Bias2)	---	6.877E-4	4.047E-3	7.326E-3	8.951E-2
N° 10 (Bias2)	---	6.019E-4	4.022E-3	7.514E-3	8.809E-2
N° 11 (Bias2)	---	7.027E-4	4.490E-3	7.889E-3	9.809E-2
N° 12 (OFF)	---	1.074E-3	4.660E-3	7.989E-3	9.158E-2
N° 13 (OFF)	---	1.040E-3	4.726E-3	8.225E-3	9.381E-2
N° 14 (OFF)	---	1.076E-3	5.037E-3	8.805E-3	1.082E-1
N° 15 (OFF)	---	9.657E-4	4.594E-3	7.772E-3	8.586E-2
N° 16 (OFF)	---	9.780E-4	4.664E-3	7.516E-3	8.899E-2
Average (OFF)	---	7.830E-4	3.680E-3	6.596E-3	6.384E-2
σ (OFF)	---	7.286E-5	1.989E-4	4.387E-4	5.700E-3
Average+3 σ (OFF)	---	1.002E-3	4.277E-3	7.912E-3	8.094E-2
Average-3 σ (OFF)	---	5.645E-4	3.084E-3	5.280E-3	4.674E-2
Average (Bias1)	---	6.552E-4	4.107E-3	7.647E-3	9.301E-2
σ (Bias1)	---	7.280E-5	2.676E-4	2.772E-4	5.097E-3
Average+3 σ (Bias1)	---	8.736E-4	4.910E-3	8.478E-3	1.083E-1
Average-3 σ (Bias1)	---	4.368E-4	3.304E-3	6.815E-3	7.772E-2
Average (Bias2)	---	1.027E-3	4.736E-3	8.061E-3	9.368E-2
σ (Bias2)	---	5.229E-5	1.743E-4	4.912E-4	8.631E-3
Average+3 σ (Bias2)	---	1.184E-3	5.259E-3	9.535E-3	1.196E-1
Average-3 σ (Bias2)	---	8.699E-4	4.213E-3	6.588E-3	6.779E-2

30 MeV proton / detailed results

13.CTR5

Ta=25°C; Vo=0.4V; If=40mA; Vcc=5V

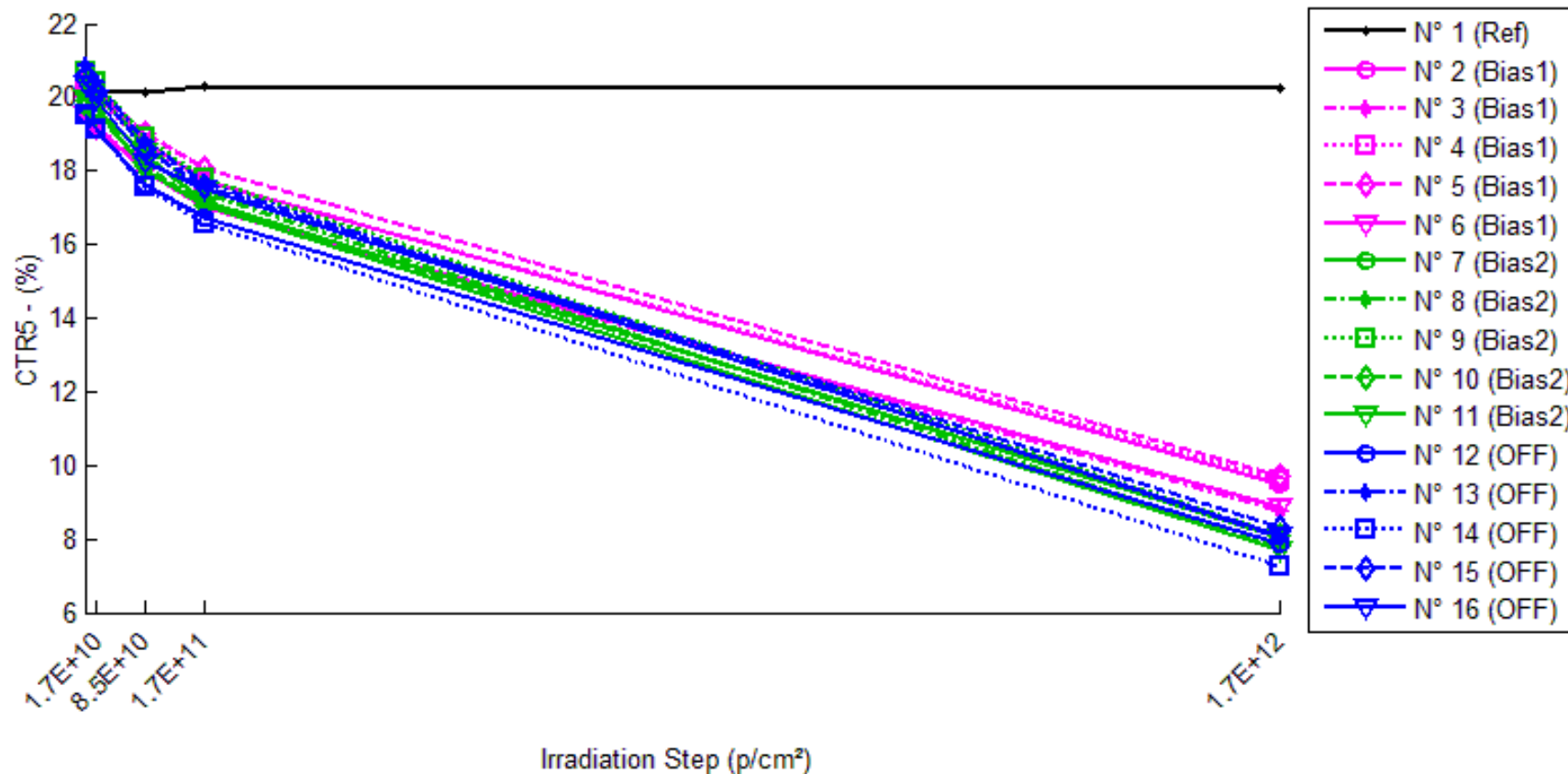

30 MeV proton / detailed results

CTR5 . (%)

	0.p/cm ²	1.7E10.p/cm ²	8.5E10.p/cm ²	1.7E11.p/cm ²	1.7E12.p/cm ²
N° 1 (Ref)	20.12	20.19	20.13	20.32	20.25
N° 2 (Bias1)	20.37	20.05	18.78	17.76	9.50
N° 3 (Bias1)	19.56	19.23	18.04	17.02	8.78
N° 4 (Bias1)	20.24	19.95	18.73	17.75	9.57
N° 5 (Bias1)	20.49	20.21	19.03	18.08	9.72
N° 6 (Bias1)	19.52	19.20	18.04	17.01	8.86
N° 7 (Bias2)	19.89	19.67	18.39	17.15	8.02
N° 8 (Bias2)	20.43	20.13	18.69	17.41	7.75
N° 9 (Bias2)	20.70	20.42	18.92	17.78	8.10
N° 10 (Bias2)	19.81	19.57	18.14	17.05	8.09
N° 11 (Bias2)	19.98	19.70	18.04	17.05	7.68
N° 12 (OFF)	19.50	19.11	17.64	16.71	7.88
N° 13 (OFF)	20.86	20.43	18.81	17.68	8.06
N° 14 (OFF)	19.52	19.14	17.57	16.54	7.28
N° 15 (OFF)	20.62	20.20	18.57	17.59	8.29
N° 16 (OFF)	20.36	19.94	18.25	17.49	8.09

1/Delta [CTR5]

	0.p/cm ²	1.7E10.p/cm ²	8.5E10.p/cm ²	1.7E11.p/cm ²	1.7E12.p/cm ²
N° 1 (Ref)	---	-1.847E-4	-3.551E-5	-4.948E-4	-3.179E-4
N° 2 (Bias1)	---	7.849E-4	4.158E-3	7.217E-3	5.621E-2
N° 3 (Bias1)	---	8.766E-4	4.305E-3	7.637E-3	6.273E-2
N° 4 (Bias1)	---	7.145E-4	3.990E-3	6.916E-3	5.507E-2
N° 5 (Bias1)	---	6.548E-4	3.721E-3	6.506E-3	5.406E-2
N° 6 (Bias1)	---	8.610E-4	4.224E-3	7.573E-3	6.160E-2
N° 7 (Bias2)	---	5.604E-4	4.097E-3	8.034E-3	7.439E-2
N° 8 (Bias2)	---	7.335E-4	4.554E-3	8.491E-3	8.013E-2
N° 9 (Bias2)	---	6.757E-4	4.540E-3	7.935E-3	7.509E-2
N° 10 (Bias2)	---	6.184E-4	4.646E-3	8.177E-3	7.318E-2
N° 11 (Bias2)	---	7.120E-4	5.392E-3	8.604E-3	8.022E-2
N° 12 (OFF)	---	1.040E-3	5.404E-3	8.541E-3	7.557E-2
N° 13 (OFF)	---	1.004E-3	5.226E-3	8.609E-3	7.610E-2
N° 14 (OFF)	---	1.002E-3	5.684E-3	9.231E-3	8.608E-2
N° 15 (OFF)	---	1.006E-3	5.358E-3	8.334E-3	7.217E-2
N° 16 (OFF)	---	1.021E-3	5.671E-3	8.067E-3	7.444E-2
Average (OFF)	---	7.784E-4	4.080E-3	7.170E-3	5.793E-2
σ (OFF)	---	9.469E-5	2.318E-4	4.712E-4	3.956E-3
Average+3 σ (OFF)	---	1.062E-3	4.775E-3	8.583E-3	6.980E-2
Average-3 σ (OFF)	---	4.943E-4	3.384E-3	5.756E-3	4.607E-2
Average (Bias1)	---	6.600E-4	4.646E-3	8.248E-3	7.660E-2
σ (Bias1)	---	7.071E-5	4.684E-4	2.891E-4	3.332E-3
Average+3 σ (Bias1)	---	8.721E-4	6.051E-3	9.116E-3	8.660E-2
Average-3 σ (Bias1)	---	4.479E-4	3.241E-3	7.381E-3	6.661E-2
Average (Bias2)	---	1.014E-3	5.469E-3	8.556E-3	7.687E-2
σ (Bias2)	---	1.591E-5	2.018E-4	4.321E-4	5.363E-3
Average+3 σ (Bias2)	---	1.062E-3	6.074E-3	9.852E-3	9.296E-2
Average-3 σ (Bias2)	---	9.666E-4	4.863E-3	7.260E-3	6.079E-2

30 MeV proton / detailed results

14.CTR6

Ta=25°C; Vo=0.4V; If=20mA; Vcc=18V

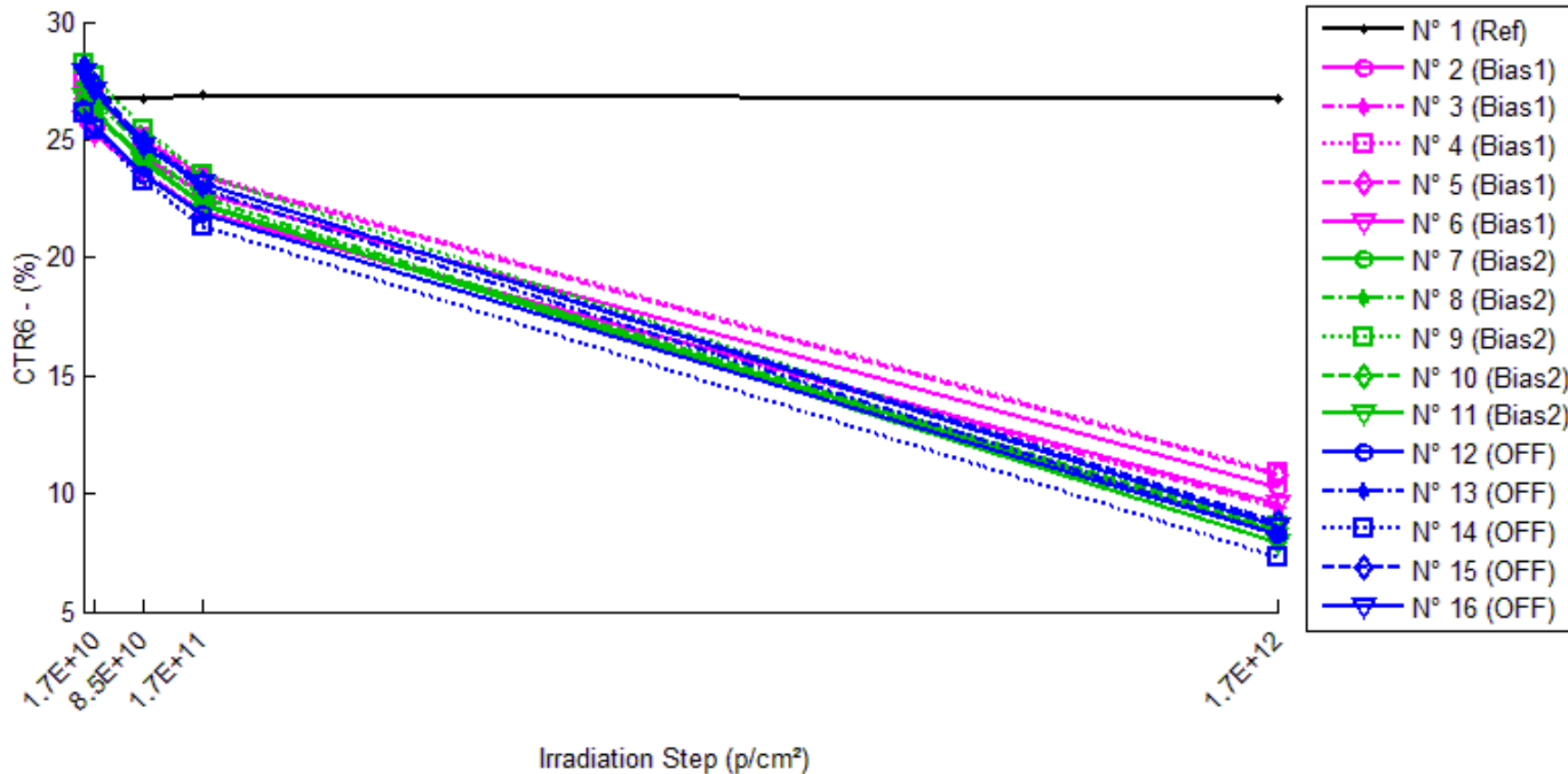

30 MeV proton / detailed results

CTR6 . (%)

	0.p/cm ²	1.7E10.p/cm ²	8.5E10.p/cm ²	1.7E11.p/cm ²	1.7E12.p/cm ²
N° 1 (Ref)	26.74	26.80	26.75	26.94	26.72
N° 2 (Bias1)	26.72	26.16	24.29	22.70	10.31
N° 3 (Bias1)	25.92	25.35	23.56	21.94	9.44
N° 4 (Bias1)	27.52	26.98	25.09	23.52	10.84
N° 5 (Bias1)	27.33	26.81	25.00	23.46	10.75
N° 6 (Bias1)	25.82	25.27	23.51	21.90	9.54
N° 7 (Bias2)	26.56	26.17	24.18	22.24	8.35
N° 8 (Bias2)	27.30	26.78	24.59	22.55	7.92
N° 9 (Bias2)	28.21	27.68	25.42	23.51	8.61
N° 10 (Bias2)	26.57	26.15	24.09	22.27	8.52
N° 11 (Bias2)	26.79	26.30	24.02	22.25	7.94
N° 12 (OFF)	26.29	25.61	23.52	21.85	8.28
N° 13 (OFF)	28.04	27.28	24.87	22.92	8.28
N° 14 (OFF)	26.14	25.45	23.21	21.37	7.34
N° 15 (OFF)	28.01	27.30	24.92	23.13	8.82
N° 16 (OFF)	27.83	27.12	24.74	23.14	8.60

1/Delta [CTR6]

	0.p/cm ²	1.7E10.p/cm ²	8.5E10.p/cm ²	1.7E11.p/cm ²	1.7E12.p/cm ²
N° 1 (Ref)	---	-7.594E-5	-6.766E-6	-2.781E-4	3.685E-5
N° 2 (Bias1)	---	7.930E-4	3.734E-3	6.620E-3	5.959E-2
N° 3 (Bias1)	---	8.631E-4	3.859E-3	6.988E-3	6.733E-2
N° 4 (Bias1)	---	7.268E-4	3.521E-3	6.187E-3	5.595E-2
N° 5 (Bias1)	---	7.002E-4	3.399E-3	6.021E-3	5.646E-2
N° 6 (Bias1)	---	8.453E-4	3.800E-3	6.925E-3	6.609E-2
N° 7 (Bias2)	---	5.689E-4	3.719E-3	7.314E-3	8.218E-2
N° 8 (Bias2)	---	7.176E-4	4.039E-3	7.714E-3	8.959E-2
N° 9 (Bias2)	---	6.732E-4	3.881E-3	7.078E-3	8.075E-2
N° 10 (Bias2)	---	6.075E-4	3.868E-3	7.257E-3	7.971E-2
N° 11 (Bias2)	---	6.891E-4	4.305E-3	7.614E-3	8.861E-2
N° 12 (OFF)	---	1.022E-3	4.489E-3	7.731E-3	8.275E-2
N° 13 (OFF)	---	9.958E-4	4.543E-3	7.967E-3	8.508E-2
N° 14 (OFF)	---	1.030E-3	4.833E-3	8.530E-3	9.799E-2
N° 15 (OFF)	---	9.238E-4	4.415E-3	7.525E-3	7.764E-2
N° 16 (OFF)	---	9.356E-4	4.489E-3	7.281E-3	8.028E-2
Average (OFF)	---	7.857E-4	3.662E-3	6.548E-3	6.108E-2
σ (OFF)	---	7.135E-5	1.950E-4	4.326E-4	5.339E-3
Average+3σ (OFF)	---	9.998E-4	4.247E-3	7.846E-3	7.710E-2
Average-3σ (OFF)	---	5.716E-4	3.077E-3	5.250E-3	4.507E-2
Average (Bias1)	---	6.512E-4	3.963E-3	7.395E-3	8.417E-2
σ (Bias1)	---	6.127E-5	2.226E-4	2.625E-4	4.602E-3
Average+3σ (Bias1)	---	8.350E-4	4.630E-3	8.183E-3	9.797E-2
Average-3σ (Bias1)	---	4.674E-4	3.295E-3	6.608E-3	7.036E-2
Average (Bias2)	---	9.815E-4	4.554E-3	7.807E-3	8.475E-2
σ (Bias2)	---	4.916E-5	1.627E-4	4.768E-4	7.906E-3
Average+3σ (Bias2)	---	1.129E-3	5.042E-3	9.237E-3	1.085E-1
Average-3σ (Bias2)	---	8.340E-4	4.066E-3	6.376E-3	6.103E-2

60 MeV proton / detailed results

CONTENTS

1. IOH	2
2. IOLeak	4
3. VF	6
4. BVr	8
5. ICCH.....	10
6. ICCL	12
7. TPLH	14
8. TPHL	16
9. CTR1	18
10. CTR2	20
11. CTR3	22
12. CTR4	24
13. CTR5	26
14. CTR6	28

60 MeV proton / detailed results

1. IOH

Ta=25°C; If=0; Vo=Vcc=18V

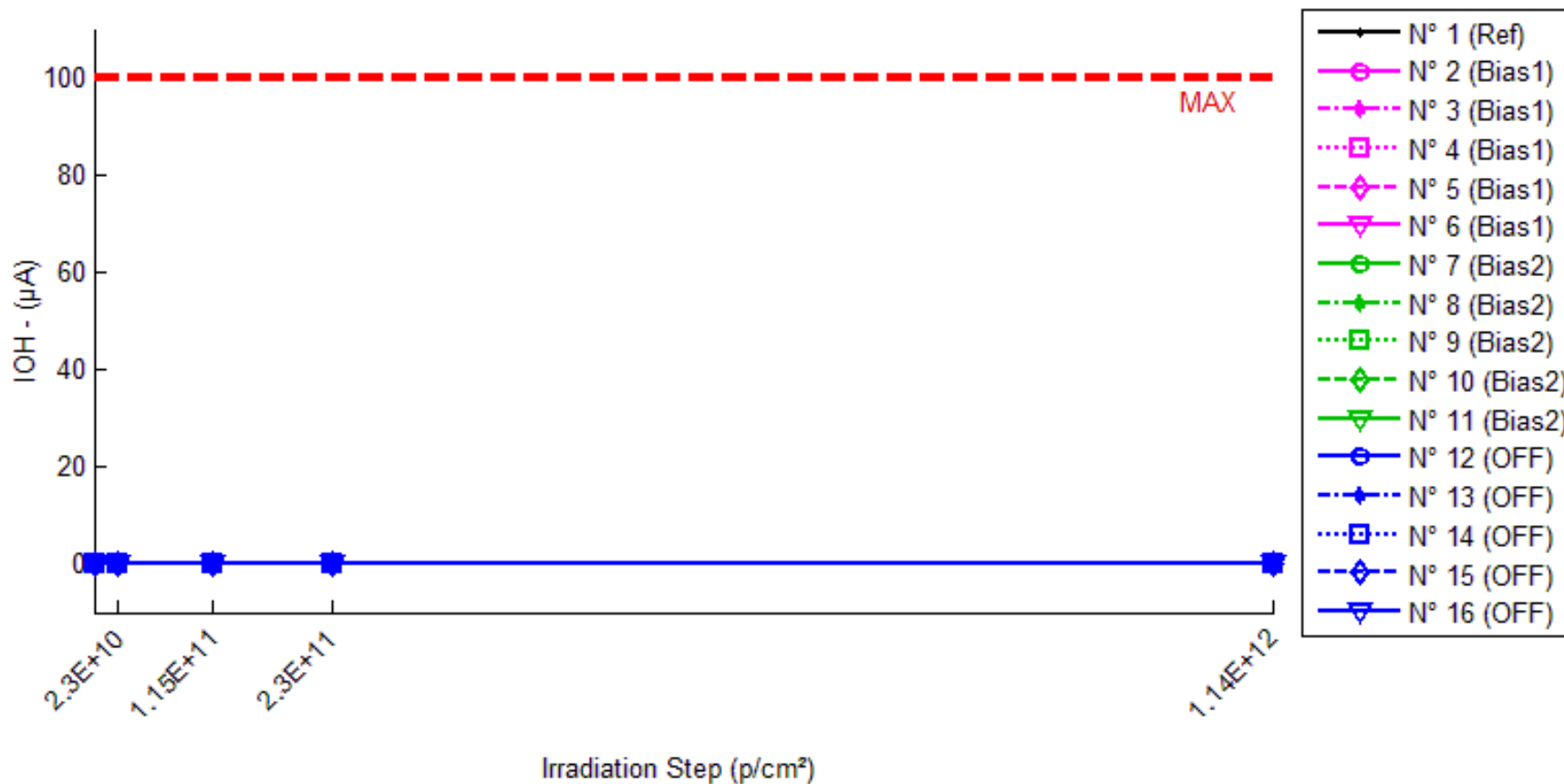

60 MeV proton / detailed results

IOH . (μA)

Max = 100.0

	0.p/cm ²	2.3E10.p/cm ²	1.15E11.p/cm ²	2.3E11.p/cm ²	1.14E12.p/cm ²
N° 1 (Ref)	1.817E-4	1.701E-4	1.653E-4	1.751E-4	1.688E-4
N° 2 (Bias1)	1.816E-4	1.750E-4	1.797E-4	1.860E-4	1.997E-4
N° 3 (Bias1)	1.871E-4	1.804E-4	1.826E-4	1.783E-4	1.952E-4
N° 4 (Bias1)	1.821E-4	1.807E-4	1.814E-4	1.850E-4	1.943E-4
N° 5 (Bias1)	1.833E-4	1.785E-4	1.739E-4	1.863E-4	1.940E-4
N° 6 (Bias1)	1.838E-4	1.801E-4	1.824E-4	1.839E-4	1.939E-4
N° 7 (Bias2)	1.821E-4	1.774E-4	1.768E-4	1.741E-4	1.901E-4
N° 8 (Bias2)	1.767E-4	1.831E-4	1.770E-4	1.821E-4	1.927E-4
N° 9 (Bias2)	1.768E-4	1.772E-4	1.775E-4	1.942E-4	1.921E-4
N° 10 (Bias2)	1.798E-4	1.767E-4	1.756E-4	1.813E-4	1.937E-4
N° 11 (Bias2)	1.751E-4	1.782E-4	1.773E-4	1.738E-4	1.934E-4
N° 12 (OFF)	1.795E-4	1.767E-4	1.800E-4	1.920E-4	2.072E-4
N° 13 (OFF)	1.802E-4	1.867E-4	1.848E-4	1.751E-4	1.974E-4
N° 14 (OFF)	1.703E-4	1.869E-4	1.861E-4	1.824E-4	1.977E-4
N° 15 (OFF)	1.802E-4	1.808E-4	1.774E-4	1.818E-4	1.943E-4
N° 16 (OFF)	1.823E-4	1.700E-4	1.783E-4	1.757E-4	1.956E-4

Delta [IOH]

	0.p/cm ²	2.3E10.p/cm ²	1.15E11.p/cm ²	2.3E11.p/cm ²	1.14E12.p/cm ²
N° 1 (Ref)	---	-1.165E-5	-1.647E-5	-6.664E-6	-1.295E-5
N° 2 (Bias1)	---	-6.664E-6	-1.969E-6	4.318E-6	1.802E-5
N° 3 (Bias1)	---	-6.664E-6	-4.443E-6	-8.801E-6	8.090E-6
N° 4 (Bias1)	---	-1.424E-6	-7.120E-7	2.851E-6	1.220E-5
N° 5 (Bias1)	---	-4.820E-6	-9.388E-6	3.018E-6	1.069E-5
N° 6 (Bias1)	---	-3.688E-6	-1.383E-6	1.260E-7	1.010E-5
N° 7 (Bias2)	---	-4.736E-6	-5.323E-6	-8.005E-6	7.964E-6
N° 8 (Bias2)	---	6.371E-6	2.940E-7	5.324E-6	1.593E-5
N° 9 (Bias2)	---	4.610E-7	6.710E-7	1.739E-5	1.534E-5
N° 10 (Bias2)	---	-3.185E-6	-4.191E-6	1.468E-6	1.387E-5
N° 11 (Bias2)	---	3.102E-6	2.180E-6	-1.341E-6	1.832E-5
N° 12 (OFF)	---	-2.808E-6	5.450E-7	1.253E-5	2.771E-5
N° 13 (OFF)	---	6.455E-6	4.569E-6	-5.071E-6	1.723E-5
N° 14 (OFF)	---	1.656E-5	1.580E-5	1.211E-5	2.737E-5
N° 15 (OFF)	---	5.870E-7	-2.724E-6	1.635E-6	1.413E-5
N° 16 (OFF)	---	-1.232E-5	-3.982E-6	-6.580E-6	1.333E-5
Average (OFF)	---	-4.652E-6	-3.579E-6	3.024E-7	1.182E-5
σ (OFF)	---	2.206E-6	3.540E-6	5.313E-6	3.767E-6
Average+3σ (OFF)	---	1.967E-6	7.041E-6	1.624E-5	2.312E-5
Average-3σ (OFF)	---	-1.127E-5	-1.420E-5	-1.564E-5	5.181E-7
Average (Bias1)	---	4.026E-7	-1.274E-6	2.968E-6	1.429E-5
σ (Bias1)	---	4.533E-6	3.282E-6	9.419E-6	3.879E-6
Average+3σ (Bias1)	---	1.400E-5	8.571E-6	3.123E-5	2.592E-5
Average-3σ (Bias1)	---	-1.320E-5	-1.112E-5	-2.529E-5	2.647E-6
Average (Bias2)	---	1.693E-6	2.842E-6	2.926E-6	1.995E-5
σ (Bias2)	---	1.074E-5	7.965E-6	9.119E-6	7.078E-6
Average+3σ (Bias2)	---	3.392E-5	2.674E-5	3.028E-5	4.118E-5
Average-3σ (Bias2)	---	-3.053E-5	-2.105E-5	-2.443E-5	-1.281E-6

60 MeV proton / detailed results

2. IOLeak

Ta=25°C; If=250µA; Vo=Vcc=18V

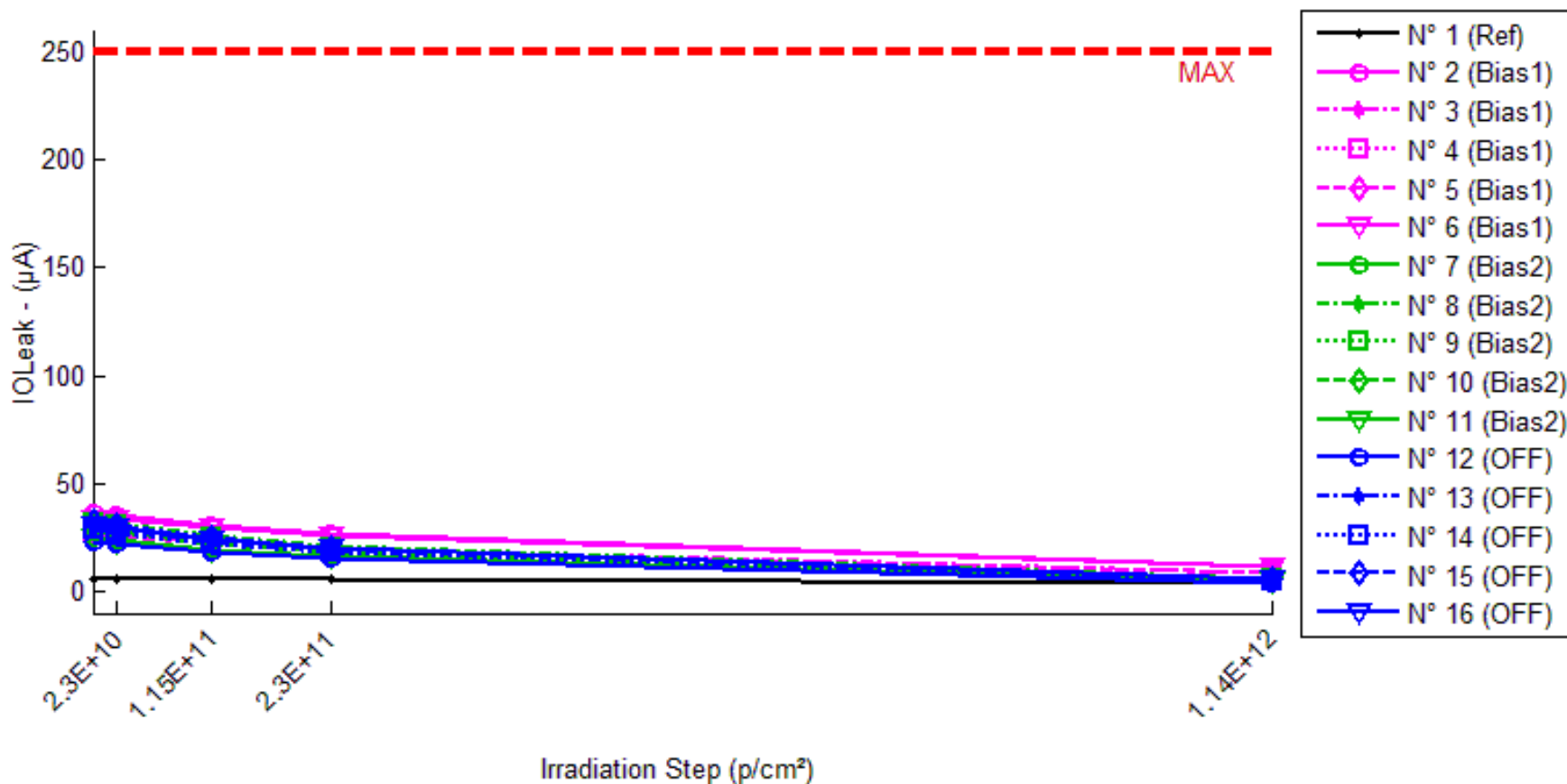

60 MeV proton / detailed results

IOLeak . (µA)

Max = 250.0

	0.p/cm ²	2.3E10.p/cm ²	1.15E11.p/cm ²	2.3E11.p/cm ²	1.14E12.p/cm ²
N° 1 (Ref)	5.875	5.938	5.922	6.000	4.002
N° 2 (Bias1)	36.270	35.119	30.920	26.865	11.497
N° 3 (Bias1)	26.992	26.013	23.021	20.076	8.593
N° 4 (Bias1)	27.070	26.379	23.272	20.469	8.702
N° 5 (Bias1)	26.169	25.569	22.543	19.354	8.585
N° 6 (Bias1)	34.038	33.468	29.543	25.579	11.284
N° 7 (Bias2)	25.422	23.878	19.406	16.193	4.772
N° 8 (Bias2)	32.920	31.312	25.652	20.976	6.230
N° 9 (Bias2)	32.126	30.666	24.920	20.391	6.018
N° 10 (Bias2)	28.866	27.465	22.452	18.173	5.371
N° 11 (Bias2)	24.749	23.354	19.125	16.021	4.772
N° 12 (OFF)	23.216	22.025	18.200	15.022	3.937
N° 13 (OFF)	30.560	29.151	23.387	19.131	4.956
N° 14 (OFF)	28.324	27.064	22.252	18.020	5.080
N° 15 (OFF)	32.869	30.894	24.840	20.155	5.421
N° 16 (OFF)	31.170	29.360	24.310	20.191	5.498

Delta [IOLeak]

	0.p/cm ²	2.3E10.p/cm ²	1.15E11.p/cm ²	2.3E11.p/cm ²	1.14E12.p/cm ²
N° 1 (Ref)	---	6.335E-2	4.698E-2	1.251E-1	-1.873E+0
N° 2 (Bias1)	---	-1.151E+0	-5.349E+0	-9.404E+0	-2.477E+1
N° 3 (Bias1)	---	-9.791E-1	-3.971E+0	-6.916E+0	-1.840E+1
N° 4 (Bias1)	---	-6.910E-1	-3.798E+0	-6.601E+0	-1.837E+1
N° 5 (Bias1)	---	-5.995E-1	-3.626E+0	-6.815E+0	-1.758E+1
N° 6 (Bias1)	---	-5.695E-1	-4.495E+0	-8.459E+0	-2.275E+1
N° 7 (Bias2)	---	-1.545E+0	-6.017E+0	-9.230E+0	-2.065E+1
N° 8 (Bias2)	---	-1.608E+0	-7.267E+0	-1.194E+1	-2.669E+1
N° 9 (Bias2)	---	-1.459E+0	-7.205E+0	-1.174E+1	-2.611E+1
N° 10 (Bias2)	---	-1.401E+0	-6.413E+0	-1.069E+1	-2.349E+1
N° 11 (Bias2)	---	-1.395E+0	-5.623E+0	-8.728E+0	-1.998E+1
N° 12 (OFF)	---	-1.192E+0	-5.016E+0	-8.194E+0	-1.928E+1
N° 13 (OFF)	---	-1.408E+0	-7.172E+0	-1.143E+1	-2.560E+1
N° 14 (OFF)	---	-1.260E+0	-6.072E+0	-1.030E+1	-2.324E+1
N° 15 (OFF)	---	-1.974E+0	-8.029E+0	-1.271E+1	-2.745E+1
N° 16 (OFF)	---	-1.810E+0	-6.861E+0	-1.098E+1	-2.567E+1
Average (OFF)	---	-7.980E-1	-4.248E+0	-7.639E+0	-2.038E+1
σ (OFF)	---	2.552E-1	6.965E-1	1.232E+0	3.191E+0
Average+3σ (OFF)	---	-3.244E-2	-2.158E+0	-3.944E+0	-1.080E+1
Average-3σ (OFF)	---	-1.564E+0	-6.337E+0	-1.133E+1	-2.995E+1
Average (Bias1)	---	-1.482E+0	-6.505E+0	-1.047E+1	-2.338E+1
σ (Bias1)	---	9.287E-2	7.239E-1	1.449E+0	3.060E+0
Average+3σ (Bias1)	---	-1.203E+0	-4.334E+0	-6.120E+0	-1.420E+1
Average-3σ (Bias1)	---	-1.760E+0	-8.677E+0	-1.481E+1	-3.256E+1
Average (Bias2)	---	-1.529E+0	-6.630E+0	-1.072E+1	-2.425E+1
σ (Bias2)	---	3.456E-1	1.142E+0	1.666E+0	3.154E+0
Average+3σ (Bias2)	---	-4.919E-1	-3.203E+0	-5.727E+0	-1.479E+1
Average-3σ (Bias2)	---	-2.566E+0	-1.006E+1	-1.572E+1	-3.371E+1

60 MeV proton / detailed results

3. VF

Ta = 25°C ; If = 20mA

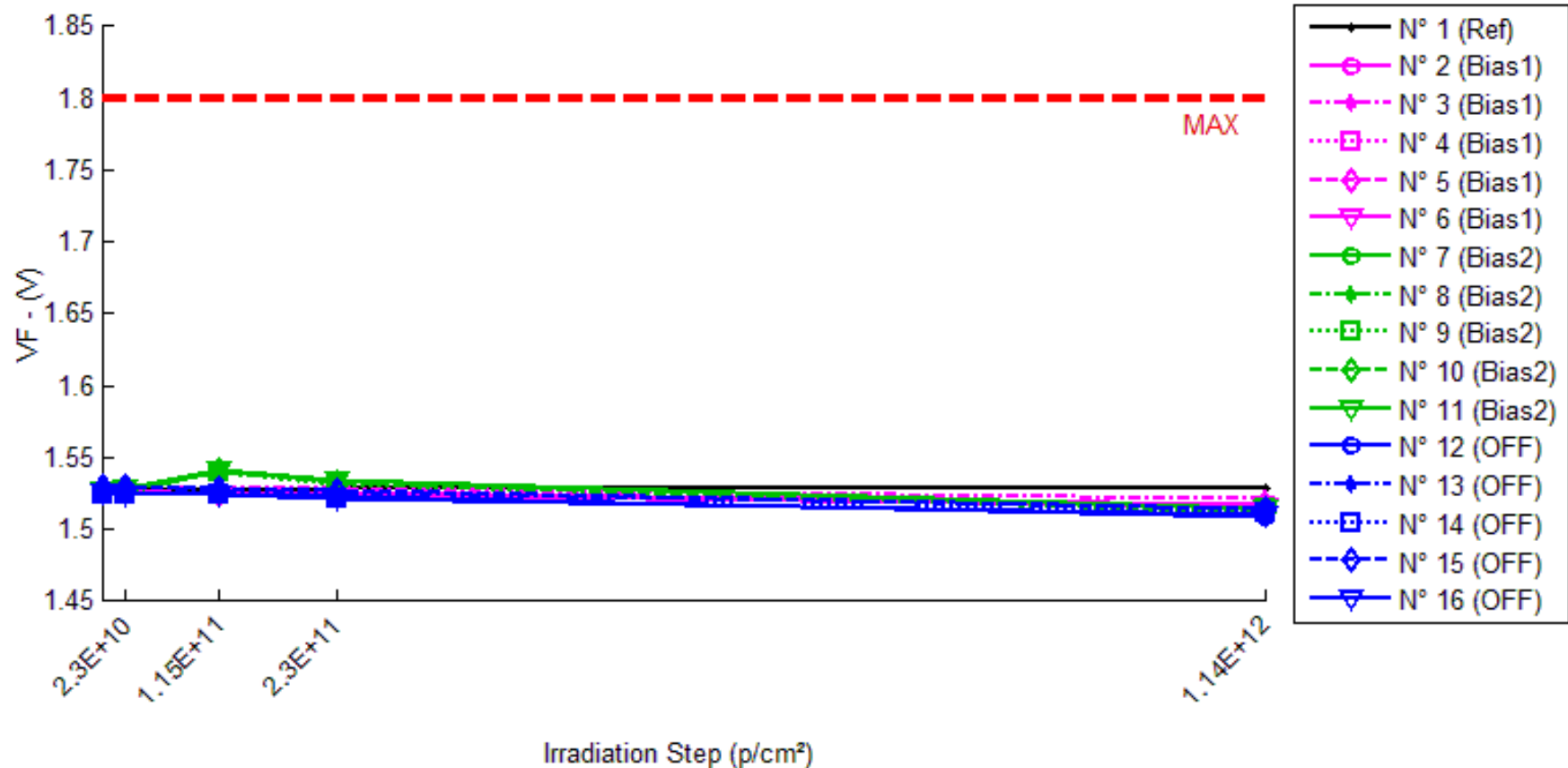

60 MeV proton / detailed results

VF . (V)

Max = 1.8

	0,p/cm ²	2.3E10.p/cm ²	1.15E11.p/cm ²	2.3E11.p/cm ²	1.14E12.p/cm ²
N° 1 (Ref)	1.529	1.529	1.528	1.529	1.529
N° 2 (Bias1)	1.527	1.528	1.525	1.526	1.517
N° 3 (Bias1)	1.531	1.531	1.529	1.529	1.521
N° 4 (Bias1)	1.526	1.527	1.525	1.525	1.516
N° 5 (Bias1)	1.526	1.527	1.525	1.525	1.517
N° 6 (Bias1)	1.526	1.526	1.524	1.524	1.516
N° 7 (Bias2)	1.526	1.527	1.540	1.534	1.515
N° 8 (Bias2)	1.525	1.527	1.542	1.533	1.515
N° 9 (Bias2)	1.525	1.526	1.540	1.531	1.515
N° 10 (Bias2)	1.526	1.527	1.541	1.533	1.512
N° 11 (Bias2)	1.527	1.529	1.542	1.534	1.515
N° 12 (OFF)	1.526	1.526	1.524	1.523	1.509
N° 13 (OFF)	1.530	1.530	1.528	1.526	1.514
N° 14 (OFF)	1.525	1.525	1.524	1.522	1.511
N° 15 (OFF)	1.530	1.530	1.529	1.527	1.515
N° 16 (OFF)	1.526	1.525	1.524	1.522	1.510

Delta [VF]

	0,p/cm ²	2.3E10.p/cm ²	1.15E11.p/cm ²	2.3E11.p/cm ²	1.14E12.p/cm ²
N° 1 (Ref)	---	8.790E-4	-2.700E-4	4.370E-4	7.300E-4
N° 2 (Bias1)	---	9.270E-4	-1.491E-3	-1.170E-3	-9.385E-3
N° 3 (Bias1)	---	-6.000E-5	-1.716E-3	-1.654E-3	-1.002E-2
N° 4 (Bias1)	---	1.102E-3	-7.830E-4	-1.092E-3	-9.498E-3
N° 5 (Bias1)	---	4.570E-4	-9.350E-4	-1.608E-3	-9.430E-3
N° 6 (Bias1)	---	6.540E-4	-1.415E-3	-1.654E-3	-9.769E-3
N° 7 (Bias2)	---	8.770E-4	1.379E-2	7.201E-3	-1.098E-2
N° 8 (Bias2)	---	2.407E-3	1.659E-2	7.995E-3	-1.006E-2
N° 9 (Bias2)	---	9.730E-4	1.466E-2	6.521E-3	-9.816E-3
N° 10 (Bias2)	---	1.529E-3	1.515E-2	7.080E-3	-1.349E-2
N° 11 (Bias2)	---	1.700E-3	1.523E-2	7.063E-3	-1.189E-2
N° 12 (OFF)	---	2.760E-4	-1.636E-3	-2.753E-3	-1.722E-2
N° 13 (OFF)	---	1.510E-4	-1.863E-3	-3.767E-3	-1.640E-2
N° 14 (OFF)	---	4.500E-4	-1.308E-3	-2.865E-3	-1.434E-2
N° 15 (OFF)	---	-2.690E-4	-1.615E-3	-3.534E-3	-1.527E-2
N° 16 (OFF)	---	-7.010E-4	-2.287E-3	-3.714E-3	-1.584E-2
Average (OFF)	---	6.160E-4	-1.268E-3	-1.436E-3	-9.621E-3
σ (OFF)	---	4.518E-4	3.931E-4	2.801E-4	2.696E-4
Average+3σ (OFF)	---	1.972E-3	-8.866E-5	-5.954E-4	-8.812E-3
Average-3σ (OFF)	---	-7.395E-4	-2.447E-3	-2.276E-3	-1.043E-2
Average (Bias1)	---	1.497E-3	1.508E-2	7.172E-3	-1.125E-2
σ (Bias1)	---	6.183E-4	1.018E-3	5.297E-4	1.498E-3
Average+3σ (Bias1)	---	3.352E-3	1.814E-2	8.761E-3	-6.755E-3
Average-3σ (Bias1)	---	-3.578E-4	1.203E-2	5.583E-3	-1.574E-2
Average (Bias2)	---	-1.860E-5	-1.742E-3	-3.327E-3	-1.581E-2
σ (Bias2)	---	4.646E-4	3.631E-4	4.820E-4	1.093E-3
Average+3σ (Bias2)	---	1.375E-3	-6.525E-4	-1.881E-3	-1.253E-2
Average-3σ (Bias2)	---	-1.412E-3	-2.831E-3	-4.772E-3	-1.909E-2

60 MeV proton / detailed results

4. B_{Vr}

T_a=25°C; I_r=10μA

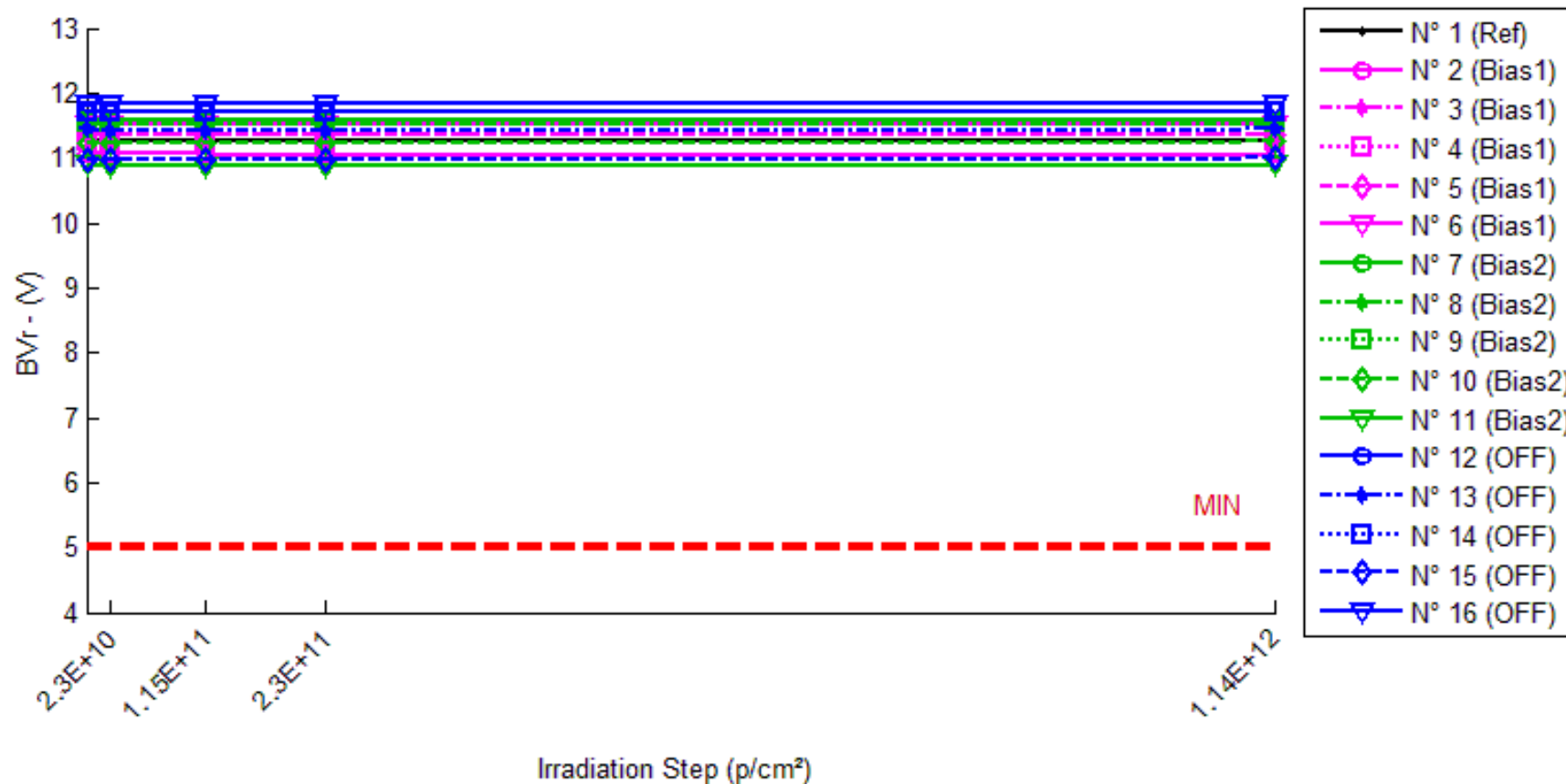

60 MeV proton / detailed results

BVr . (V)

Min = 5.0

	0,p/cm ²	2.3E10,p/cm ²	1.15E11,p/cm ²	2.3E11,p/cm ²	1.14E12,p/cm ²
N° 1 (Ref)	11.259	11.250	11.253	11.250	11.249
N° 2 (Bias1)	11.064	11.055	11.059	11.051	11.058
N° 3 (Bias1)	11.371	11.366	11.366	11.359	11.365
N° 4 (Bias1)	11.252	11.243	11.244	11.240	11.248
N° 5 (Bias1)	11.374	11.365	11.365	11.363	11.365
N° 6 (Bias1)	11.517	11.509	11.511	11.506	11.513
N° 7 (Bias2)	11.596	11.591	11.591	11.589	11.584
N° 8 (Bias2)	11.525	11.513	11.510	11.507	11.511
N° 9 (Bias2)	11.545	11.539	11.539	11.539	11.532
N° 10 (Bias2)	11.243	11.235	11.236	11.234	11.246
N° 11 (Bias2)	10.900	10.891	10.892	10.890	10.899
N° 12 (OFF)	11.721	11.709	11.711	11.708	11.728
N° 13 (OFF)	11.442	11.431	11.433	11.432	11.444
N° 14 (OFF)	11.707	11.695	11.696	11.697	11.708
N° 15 (OFF)	10.988	10.979	10.979	10.981	10.991
N° 16 (OFF)	11.827	11.820	11.821	11.822	11.838

Delta [BVr]

	0,p/cm ²	2.3E10,p/cm ²	1.15E11,p/cm ²	2.3E11,p/cm ²	1.14E12,p/cm ²
N° 1 (Ref)	---	-9.100E-3	-6.400E-3	-9.380E-3	-1.010E-2
N° 2 (Bias1)	---	-8.490E-3	-5.170E-3	-1.225E-2	-6.090E-3
N° 3 (Bias1)	---	-4.700E-3	-5.280E-3	-1.216E-2	-5.750E-3
N° 4 (Bias1)	---	-9.360E-3	-7.690E-3	-1.222E-2	-3.600E-3
N° 5 (Bias1)	---	-8.390E-3	-8.800E-3	-1.106E-2	-8.990E-3
N° 6 (Bias1)	---	-8.610E-3	-6.040E-3	-1.128E-2	-4.110E-3
N° 7 (Bias2)	---	-5.050E-3	-4.870E-3	-7.210E-3	-1.218E-2
N° 8 (Bias2)	---	-1.156E-2	-1.452E-2	-1.804E-2	-1.422E-2
N° 9 (Bias2)	---	-6.030E-3	-6.240E-3	-5.970E-3	-1.259E-2
N° 10 (Bias2)	---	-8.280E-3	-7.440E-3	-9.400E-3	2.620E-3
N° 11 (Bias2)	---	-8.910E-3	-7.500E-3	-9.350E-3	-1.000E-3
N° 12 (OFF)	---	-1.208E-2	-9.810E-3	-1.250E-2	7.460E-3
N° 13 (OFF)	---	-1.084E-2	-9.290E-3	-9.850E-3	1.920E-3
N° 14 (OFF)	---	-1.187E-2	-1.046E-2	-9.260E-3	1.540E-3
N° 15 (OFF)	---	-8.180E-3	-9.120E-3	-6.850E-3	3.270E-3
N° 16 (OFF)	---	-6.660E-3	-5.440E-3	-4.720E-3	1.107E-2
Average (OFF)	---	-7.910E-3	-6.596E-3	-1.179E-2	-5.708E-3
σ (OFF)	---	1.835E-3	1.591E-3	5.758E-4	2.116E-3
Average+3σ (OFF)	---	-2.406E-3	-1.822E-3	-1.007E-2	6.412E-4
Average-3σ (OFF)	---	-1.341E-2	-1.137E-2	-1.352E-2	-1.206E-2
Average (Bias1)	---	-7.966E-3	-8.114E-3	-9.994E-3	-7.474E-3
σ (Bias1)	---	2.557E-3	3.738E-3	4.729E-3	7.708E-3
Average+3σ (Bias1)	---	-2.943E-4	3.101E-3	4.193E-3	1.565E-2
Average-3σ (Bias1)	---	-1.564E-2	-1.933E-2	-2.418E-2	-3.060E-2
Average (Bias2)	---	-9.926E-3	-8.824E-3	-8.636E-3	5.052E-3
σ (Bias2)	---	2.396E-3	1.962E-3	2.971E-3	4.103E-3
Average+3σ (Bias2)	---	-2.737E-3	-2.937E-3	2.784E-4	1.736E-2
Average-3σ (Bias2)	---	-1.711E-2	-1.471E-2	-1.755E-2	-7.257E-3

60 MeV proton / detailed results

5. ICCH

Ta=25°C; Vcc=18V; If=0

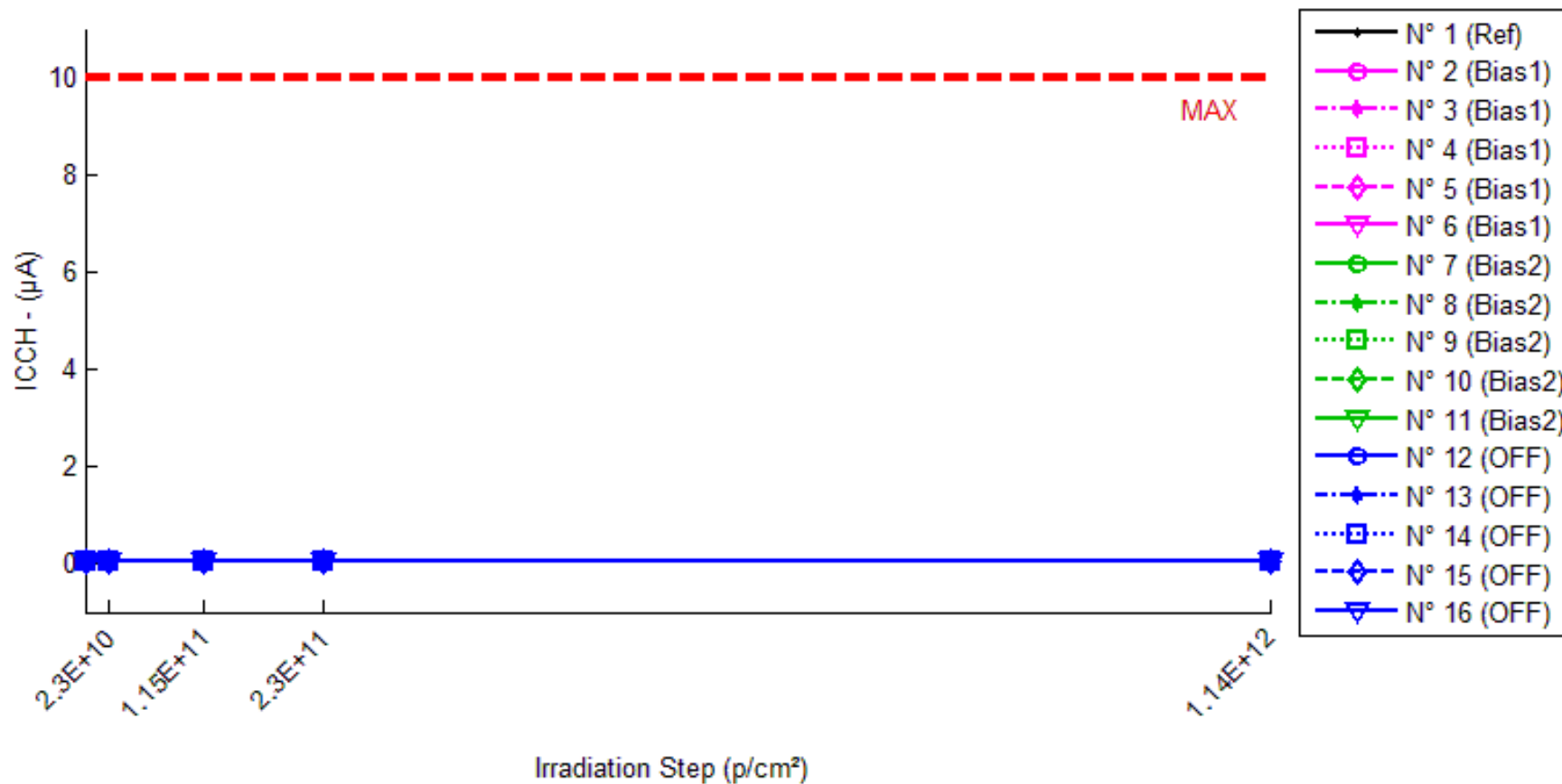

60 MeV proton / detailed results

ICCH. (μA)

Max = 10.0

	0,p/cm ²	2.3E10,p/cm ²	1.15E11,p/cm ²	2.3E11,p/cm ²	1.14E12,p/cm ²
N° 1 (Ref)	0.040	0.047	0.052	0.052	0.046
N° 2 (Bias1)	0.044	0.054	0.050	0.045	0.040
N° 3 (Bias1)	0.048	0.050	0.052	0.046	0.055
N° 4 (Bias1)	0.056	0.042	0.053	0.057	0.052
N° 5 (Bias1)	0.056	0.047	0.050	0.046	0.043
N° 6 (Bias1)	0.046	0.050	0.051	0.045	0.047
N° 7 (Bias2)	0.050	0.050	0.042	0.044	0.045
N° 8 (Bias2)	0.044	0.046	0.045	0.051	0.049
N° 9 (Bias2)	0.045	0.046	0.039	0.041	0.049
N° 10 (Bias2)	0.045	0.046	0.048	0.048	0.046
N° 11 (Bias2)	0.049	0.048	0.044	0.051	0.045
N° 12 (OFF)	0.049	0.046	0.042	0.054	0.042
N° 13 (OFF)	0.048	0.042	0.054	0.048	0.047
N° 14 (OFF)	0.045	0.042	0.041	0.051	0.053
N° 15 (OFF)	0.045	0.042	0.054	0.042	0.050
N° 16 (OFF)	0.046	0.047	0.051	0.057	0.045

Delta [ICCH]

	0,p/cm ²	2.3E10,p/cm ²	1.15E11,p/cm ²	2.3E11,p/cm ²	1.14E12,p/cm ²
N° 1 (Ref)	---	6.460E-3	1.163E-2	1.139E-2	6.170E-3
N° 2 (Bias1)	---	9.960E-3	5.790E-3	1.250E-3	-4.140E-3
N° 3 (Bias1)	---	2.360E-3	4.430E-3	-1.500E-3	6.790E-3
N° 4 (Bias1)	---	-1.358E-2	-2.400E-3	1.520E-3	-3.770E-3
N° 5 (Bias1)	---	-9.050E-3	-5.690E-3	-1.033E-2	-1.308E-2
N° 6 (Bias1)	---	4.630E-3	5.250E-3	-3.100E-4	9.000E-4
N° 7 (Bias2)	---	-7.800E-4	-8.520E-3	-6.760E-3	-5.090E-3
N° 8 (Bias2)	---	1.540E-3	1.090E-3	6.450E-3	4.130E-3
N° 9 (Bias2)	---	1.400E-3	-5.470E-3	-3.570E-3	4.210E-3
N° 10 (Bias2)	---	9.100E-4	2.590E-3	3.040E-3	9.500E-4
N° 11 (Bias2)	---	-1.850E-3	-5.310E-3	1.480E-3	-4.120E-3
N° 12 (OFF)	---	-2.960E-3	-6.610E-3	5.110E-3	-6.920E-3
N° 13 (OFF)	---	-6.090E-3	5.240E-3	-7.500E-4	-1.510E-3
N° 14 (OFF)	---	-3.270E-3	-4.030E-3	6.220E-3	7.980E-3
N° 15 (OFF)	---	-3.920E-3	8.910E-3	-3.280E-3	4.040E-3
N° 16 (OFF)	---	1.050E-3	4.950E-3	1.160E-2	-3.300E-4
Average (OFF)	---	-1.136E-3	1.476E-3	-1.874E-3	-2.660E-3
σ (OFF)	---	9.824E-3	5.195E-3	4.883E-3	7.314E-3
Average+3 σ (OFF)	---	2.834E-2	1.706E-2	1.277E-2	1.928E-2
Average-3 σ (OFF)	---	-3.061E-2	-1.411E-2	-1.652E-2	-2.460E-2
Average (Bias1)	---	2.440E-4	-3.124E-3	1.280E-4	1.600E-5
σ (Bias1)	---	1.491E-3	4.738E-3	5.277E-3	4.432E-3
Average+3 σ (Bias1)	---	4.717E-3	1.109E-2	1.596E-2	1.331E-2
Average-3 σ (Bias1)	---	-4.229E-3	-1.734E-2	-1.570E-2	-1.328E-2
Average (Bias2)	---	-3.038E-3	1.692E-3	3.780E-3	6.520E-4
σ (Bias2)	---	2.592E-3	6.651E-3	5.900E-3	5.660E-3
Average+3 σ (Bias2)	---	4.737E-3	2.165E-2	2.148E-2	1.763E-2
Average-3 σ (Bias2)	---	-1.081E-2	-1.826E-2	-1.392E-2	-1.633E-2

60 MeV proton / detailed results

6. ICCL

Ta=25°C; Vcc=18V; If=20mA

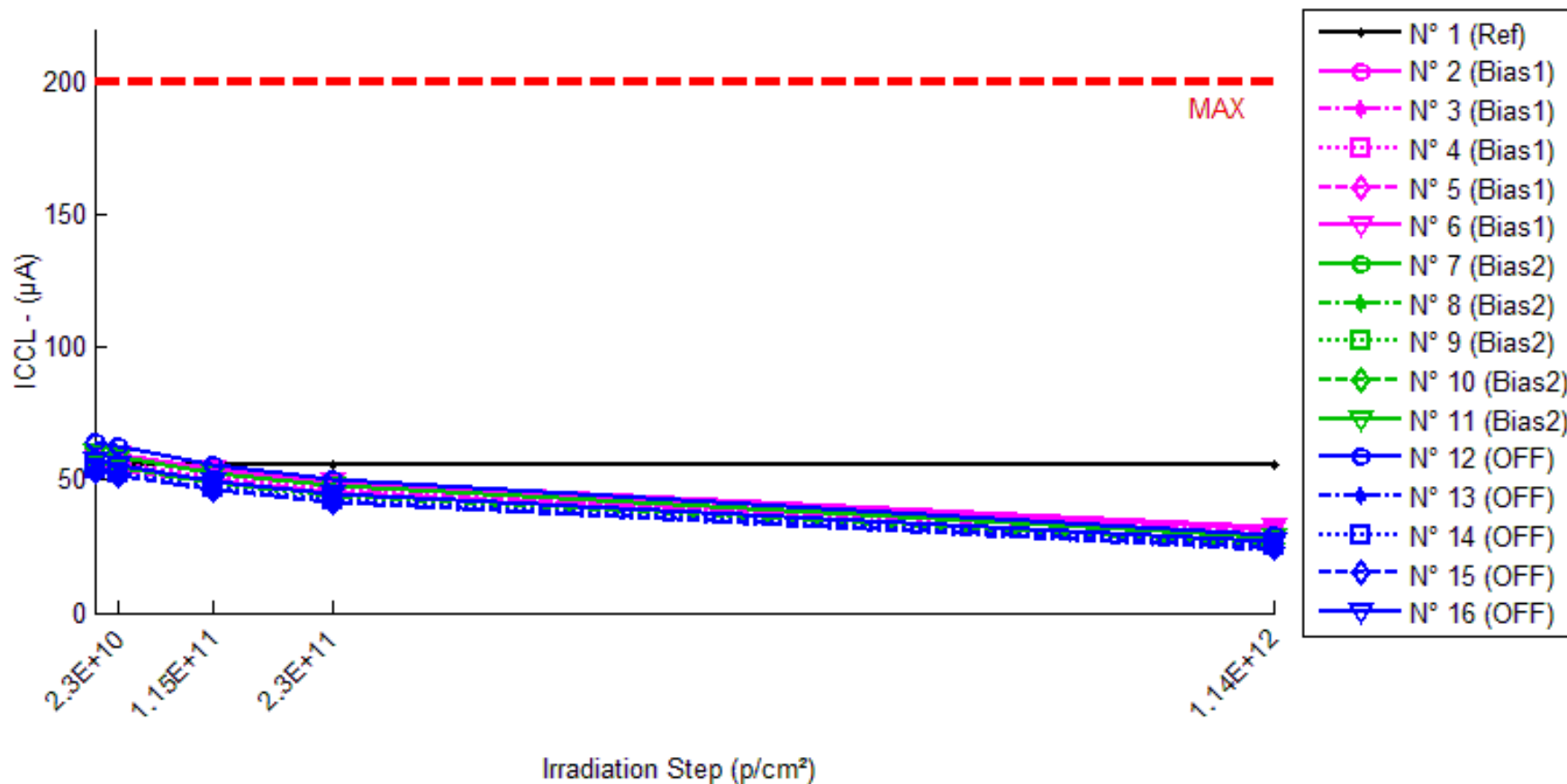

60 MeV proton / detailed results

ICCL . (µA)

Max = 200.0

	0.p/cm ²	2.3E10.p/cm ²	1.15E11.p/cm ²	2.3E11.p/cm ²	1.14E12.p/cm ²
N° 1 (Ref)	55.608	55.985	55.847	55.989	56.017
N° 2 (Bias1)	59.843	58.686	53.302	48.990	31.578
N° 3 (Bias1)	56.194	54.919	50.050	45.924	29.395
N° 4 (Bias1)	57.307	56.224	51.398	47.234	30.815
N° 5 (Bias1)	54.614	53.603	49.211	45.287	29.722
N° 6 (Bias1)	60.553	59.381	54.227	49.839	32.416
N° 7 (Bias2)	56.464	54.828	49.161	44.541	26.847
N° 8 (Bias2)	56.995	55.397	49.313	44.194	25.597
N° 9 (Bias2)	56.586	54.907	49.124	44.322	26.553
N° 10 (Bias2)	56.336	54.819	49.102	44.547	26.327
N° 11 (Bias2)	60.626	58.991	52.618	47.633	28.364
N° 12 (OFF)	64.123	62.471	55.769	50.369	29.201
N° 13 (OFF)	53.245	51.726	46.093	41.413	24.034
N° 14 (OFF)	53.845	52.487	47.086	42.573	25.585
N° 15 (OFF)	53.270	51.695	46.270	41.576	24.461
N° 16 (OFF)	57.485	55.773	49.862	44.934	26.617

Delta [ICCL]

	0.p/cm ²	2.3E10.p/cm ²	1.15E11.p/cm ²	2.3E11.p/cm ²	1.14E12.p/cm ²
N° 1 (Ref)	---	3.770E-1	2.390E-1	3.810E-1	4.096E-1
N° 2 (Bias1)	---	-1.157E+0	-6.541E+0	-1.085E+1	-2.826E+1
N° 3 (Bias1)	---	-1.274E+0	-6.144E+0	-1.027E+1	-2.680E+1
N° 4 (Bias1)	---	-1.084E+0	-5.910E+0	-1.007E+1	-2.649E+1
N° 5 (Bias1)	---	-1.011E+0	-5.403E+0	-9.327E+0	-2.489E+1
N° 6 (Bias1)	---	-1.173E+0	-6.326E+0	-1.071E+1	-2.814E+1
N° 7 (Bias2)	---	-1.636E+0	-7.303E+0	-1.192E+1	-2.962E+1
N° 8 (Bias2)	---	-1.598E+0	-7.682E+0	-1.280E+1	-3.140E+1
N° 9 (Bias2)	---	-1.679E+0	-7.463E+0	-1.226E+1	-3.003E+1
N° 10 (Bias2)	---	-1.518E+0	-7.234E+0	-1.179E+1	-3.001E+1
N° 11 (Bias2)	---	-1.635E+0	-8.008E+0	-1.299E+1	-3.226E+1
N° 12 (OFF)	---	-1.652E+0	-8.354E+0	-1.375E+1	-3.492E+1
N° 13 (OFF)	---	-1.519E+0	-7.153E+0	-1.183E+1	-2.921E+1
N° 14 (OFF)	---	-1.358E+0	-6.758E+0	-1.127E+1	-2.826E+1
N° 15 (OFF)	---	-1.576E+0	-7.000E+0	-1.169E+1	-2.881E+1
N° 16 (OFF)	---	-1.712E+0	-7.622E+0	-1.255E+1	-3.087E+1
Average (OFF)	---	-1.140E+0	-6.065E+0	-1.025E+1	-2.692E+1
σ (OFF)	---	9.906E-2	4.367E-1	6.049E-1	1.378E+0
Average+3σ (OFF)	---	-8.426E-1	-4.755E+0	-8.433E+0	-2.278E+1
Average-3σ (OFF)	---	-1.437E+0	-7.375E+0	-1.206E+1	-3.105E+1
Average (Bias1)	---	-1.613E+0	-7.538E+0	-1.235E+1	-3.066E+1
σ (Bias1)	---	6.077E-2	3.142E-1	5.295E-1	1.120E+0
Average+3σ (Bias1)	---	-1.431E+0	-6.596E+0	-1.077E+1	-2.731E+1
Average-3σ (Bias1)	---	-1.796E+0	-8.481E+0	-1.394E+1	-3.402E+1
Average (Bias2)	---	-1.563E+0	-7.377E+0	-1.222E+1	-3.041E+1
σ (Bias2)	---	1.363E-1	6.303E-1	9.729E-1	2.701E+0
Average+3σ (Bias2)	---	-1.154E+0	-5.487E+0	-9.302E+0	-2.231E+1
Average-3σ (Bias2)	---	-1.972E+0	-9.268E+0	-1.514E+1	-3.852E+1

60 MeV proton / detailed results

7. TPLH

Ta=25°C; RL=8.2 kOhms; Cl=50pF; If=16mA; Vcc=5V

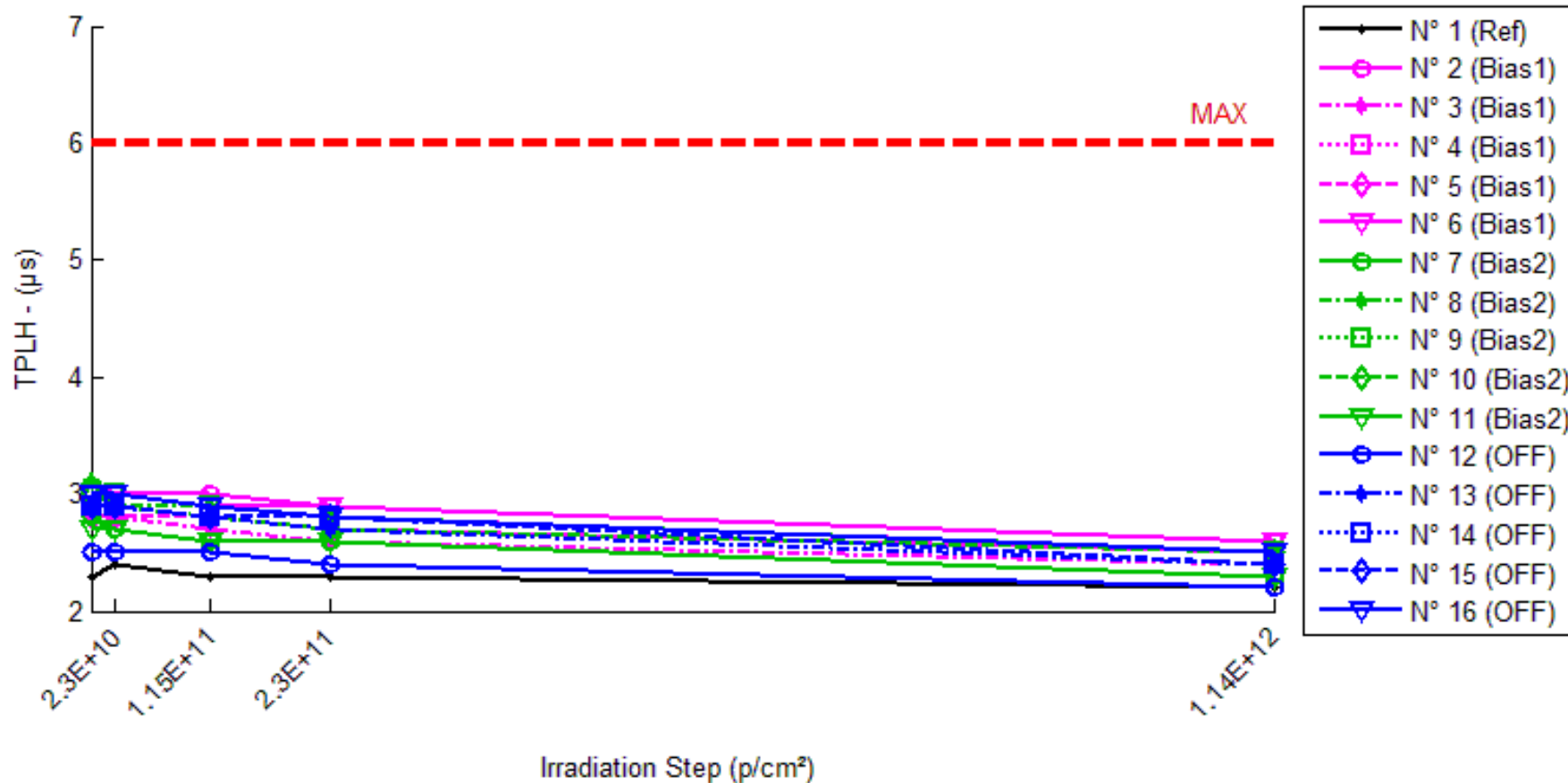

60 MeV proton / detailed results

TPH . (µs) Max = 6.0

	0.p/cm ²	2.3E10.p/cm ²	1.15E11.p/cm ²	2.3E11.p/cm ²	1.14E12.p/cm ²
N° 1 (Ref)	2.3	2.4	2.3	2.3	2.2
N° 2 (Bias1)	3.0	3.0	3.0	2.9	2.6
N° 3 (Bias1)	2.8	2.8	2.7	2.6	2.4
N° 4 (Bias1)	3.0	2.9	2.9	2.8	2.5
N° 5 (Bias1)	2.8	2.8	2.8	2.7	2.5
N° 6 (Bias1)	3.0	3.0	2.9	2.9	2.6
N° 7 (Bias2)	2.8	2.7	2.6	2.6	2.3
N° 8 (Bias2)	3.1	2.9	2.9	2.8	2.5
N° 9 (Bias2)	3.0	3.0	2.9	2.8	2.5
N° 10 (Bias2)	3.0	2.9	2.8	2.7	2.5
N° 11 (Bias2)	2.7	2.7	2.6	2.6	2.3
N° 12 (OFF)	2.5	2.5	2.5	2.4	2.2
N° 13 (OFF)	2.9	2.9	2.8	2.7	2.4
N° 14 (OFF)	2.9	2.9	2.8	2.8	2.4
N° 15 (OFF)	2.9	2.9	2.8	2.8	2.4
N° 16 (OFF)	3.0	3.0	2.9	2.8	2.5

Delta [TPH]

	0.p/cm ²	2.3E10.p/cm ²	1.15E11.p/cm ²	2.3E11.p/cm ²	1.14E12.p/cm ²
N° 1 (Ref)	---	1.000E-1	0.000E+0	0.000E+0	-1.000E-1
N° 2 (Bias1)	---	0.000E+0	0.000E+0	-1.000E-1	-4.000E-1
N° 3 (Bias1)	---	5.000E-2	-5.000E-2	-1.000E-1	-3.500E-1
N° 4 (Bias1)	---	-1.000E-1	-1.000E-1	-2.000E-1	-4.500E-1
N° 5 (Bias1)	---	0.000E+0	0.000E+0	-1.000E-1	-3.000E-1
N° 6 (Bias1)	---	5.000E-2	-5.000E-2	-5.000E-2	-3.500E-1
N° 7 (Bias2)	---	-1.000E-1	-2.000E-1	-2.000E-1	-5.000E-1
N° 8 (Bias2)	---	-2.000E-1	-2.500E-1	-3.000E-1	-6.000E-1
N° 9 (Bias2)	---	0.000E+0	-1.000E-1	-2.000E-1	-5.000E-1
N° 10 (Bias2)	---	-1.000E-1	-2.000E-1	-3.000E-1	-5.000E-1
N° 11 (Bias2)	---	0.000E+0	-1.000E-1	-1.000E-1	-4.000E-1
N° 12 (OFF)	---	0.000E+0	0.000E+0	-1.000E-1	-3.000E-1
N° 13 (OFF)	---	0.000E+0	-1.000E-1	-2.000E-1	-5.000E-1
N° 14 (OFF)	---	0.000E+0	-1.000E-1	-1.500E-1	-5.000E-1
N° 15 (OFF)	---	0.000E+0	-1.000E-1	-1.500E-1	-5.000E-1
N° 16 (OFF)	---	0.000E+0	-1.500E-1	-2.000E-1	-5.000E-1
Average (OFF)	---	-8.882E-17	-4.000E-2	-1.100E-1	-3.700E-1
σ (OFF)	---	6.124E-2	4.183E-2	5.477E-2	5.701E-2
Average+3σ (OFF)	---	1.837E-1	8.550E-2	5.432E-2	-1.990E-1
Average-3σ (OFF)	---	-1.837E-1	-1.655E-1	-2.743E-1	-5.410E-1
Average (Bias1)	---	-8.000E-2	-1.700E-1	-2.200E-1	-5.000E-1
σ (Bias1)	---	8.367E-2	6.708E-2	8.367E-2	7.071E-2
Average+3σ (Bias1)	---	1.710E-1	3.125E-2	3.100E-2	-2.879E-1
Average-3σ (Bias1)	---	-3.310E-1	-3.712E-1	-4.710E-1	-7.121E-1
Average (Bias2)	---	0.000E+0	-9.000E-2	-1.600E-1	-4.600E-1
σ (Bias2)	---	0.000E+0	5.477E-2	4.183E-2	8.944E-2
Average+3σ (Bias2)	---	0.000E+0	7.432E-2	-3.450E-2	-1.917E-1
Average-3σ (Bias2)	---	0.000E+0	-2.543E-1	-2.855E-1	-7.283E-1

60 MeV proton / detailed results

8. TPHL

Ta=25°C; RL=8.2 kOhms; Cl=50pF; If=16mA; Vcc=5V

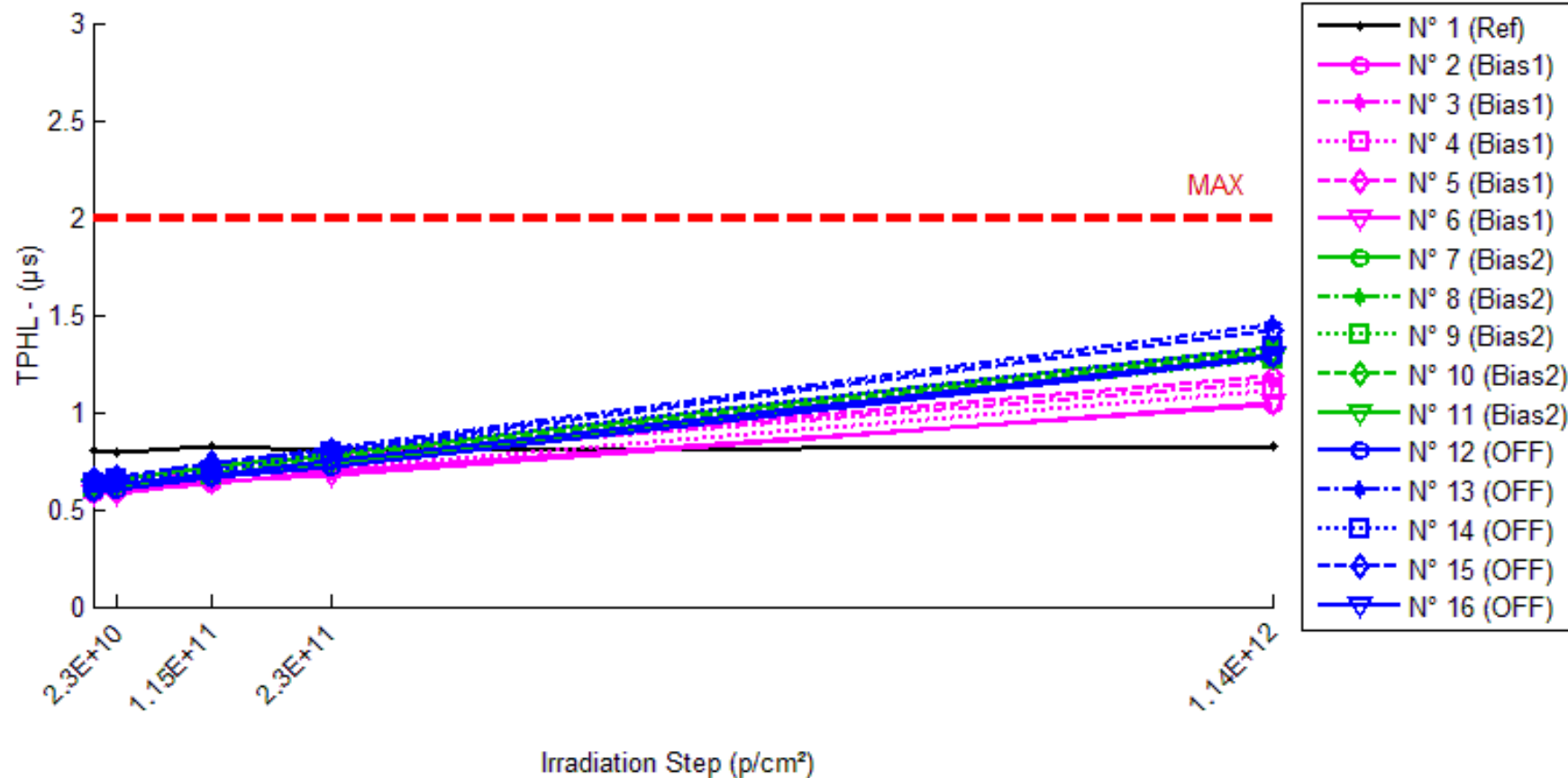

60 MeV proton / detailed results

TPHL . (µs)

Max = 2.0

	0.p/cm ²	2.3E10.p/cm ²	1.15E11.p/cm ²	2.3E11.p/cm ²	1.14E12.p/cm ²
N° 1 (Ref)	0.80	0.79	0.82	0.80	0.82
N° 2 (Bias1)	0.58	0.59	0.63	0.70	1.04
N° 3 (Bias1)	0.62	0.64	0.69	0.76	1.15
N° 4 (Bias1)	0.60	0.62	0.68	0.71	1.11
N° 5 (Bias1)	0.65	0.67	0.72	0.77	1.19
N° 6 (Bias1)	0.58	0.58	0.64	0.68	1.05
N° 7 (Bias2)	0.64	0.65	0.72	0.78	1.33
N° 8 (Bias2)	0.61	0.62	0.69	0.78	1.34
N° 9 (Bias2)	0.61	0.63	0.68	0.75	1.27
N° 10 (Bias2)	0.61	0.63	0.70	0.77	1.31
N° 11 (Bias2)	0.61	0.62	0.68	0.74	1.28
N° 12 (OFF)	0.59	0.60	0.66	0.72	1.28
N° 13 (OFF)	0.64	0.66	0.74	0.81	1.45
N° 14 (OFF)	0.63	0.65	0.70	0.79	1.34
N° 15 (OFF)	0.65	0.66	0.74	0.80	1.42
N° 16 (OFF)	0.60	0.63	0.68	0.75	1.29

Delta [TPHL]

	0.p/cm ²	2.3E10.p/cm ²	1.15E11.p/cm ²	2.3E11.p/cm ²	1.14E12.p/cm ²
N° 1 (Ref)	---	-1.000E-2	2.000E-2	0.000E+0	2.000E-2
N° 2 (Bias1)	---	1.000E-2	5.000E-2	1.200E-1	4.600E-1
N° 3 (Bias1)	---	2.000E-2	7.000E-2	1.400E-1	5.300E-1
N° 4 (Bias1)	---	2.000E-2	8.000E-2	1.100E-1	5.100E-1
N° 5 (Bias1)	---	2.000E-2	7.000E-2	1.200E-1	5.400E-1
N° 6 (Bias1)	---	0.000E+0	6.000E-2	1.000E-1	4.700E-1
N° 7 (Bias2)	---	1.000E-2	8.000E-2	1.400E-1	6.900E-1
N° 8 (Bias2)	---	1.000E-2	8.000E-2	1.700E-1	7.300E-1
N° 9 (Bias2)	---	2.000E-2	7.000E-2	1.400E-1	6.600E-1
N° 10 (Bias2)	---	2.000E-2	9.000E-2	1.600E-1	7.000E-1
N° 11 (Bias2)	---	1.000E-2	7.000E-2	1.300E-1	6.700E-1
N° 12 (OFF)	---	1.000E-2	7.000E-2	1.300E-1	6.900E-1
N° 13 (OFF)	---	2.000E-2	1.000E-1	1.700E-1	8.100E-1
N° 14 (OFF)	---	2.000E-2	7.000E-2	1.600E-1	7.100E-1
N° 15 (OFF)	---	1.000E-2	9.000E-2	1.500E-1	7.700E-1
N° 16 (OFF)	---	3.000E-2	8.000E-2	1.500E-1	6.900E-1
Average (OFF)	---	1.400E-2	6.600E-2	1.180E-1	5.020E-1
σ (OFF)	---	8.944E-3	1.140E-2	1.483E-2	3.564E-2
Average+3σ (OFF)	---	4.083E-2	1.002E-1	1.625E-1	6.089E-1
Average-3σ (OFF)	---	-1.283E-2	3.179E-2	7.350E-2	3.951E-1
Average (Bias1)	---	1.400E-2	7.800E-2	1.480E-1	6.900E-1
σ (Bias1)	---	5.477E-3	8.367E-3	1.643E-2	2.739E-2
Average+3σ (Bias1)	---	3.043E-2	1.031E-1	1.973E-1	7.722E-1
Average-3σ (Bias1)	---	-2.432E-3	5.290E-2	9.870E-2	6.078E-1
Average (Bias2)	---	1.800E-2	8.200E-2	1.520E-1	7.340E-1
σ (Bias2)	---	8.367E-3	1.304E-2	1.483E-2	5.367E-2
Average+3σ (Bias2)	---	4.310E-2	1.211E-1	1.965E-1	8.950E-1
Average-3σ (Bias2)	---	-7.100E-3	4.288E-2	1.075E-1	5.730E-1

60 MeV proton / detailed results

9. CTR1

Ta=25°C; Vo=0.4V; If=2mA; Vcc=5V

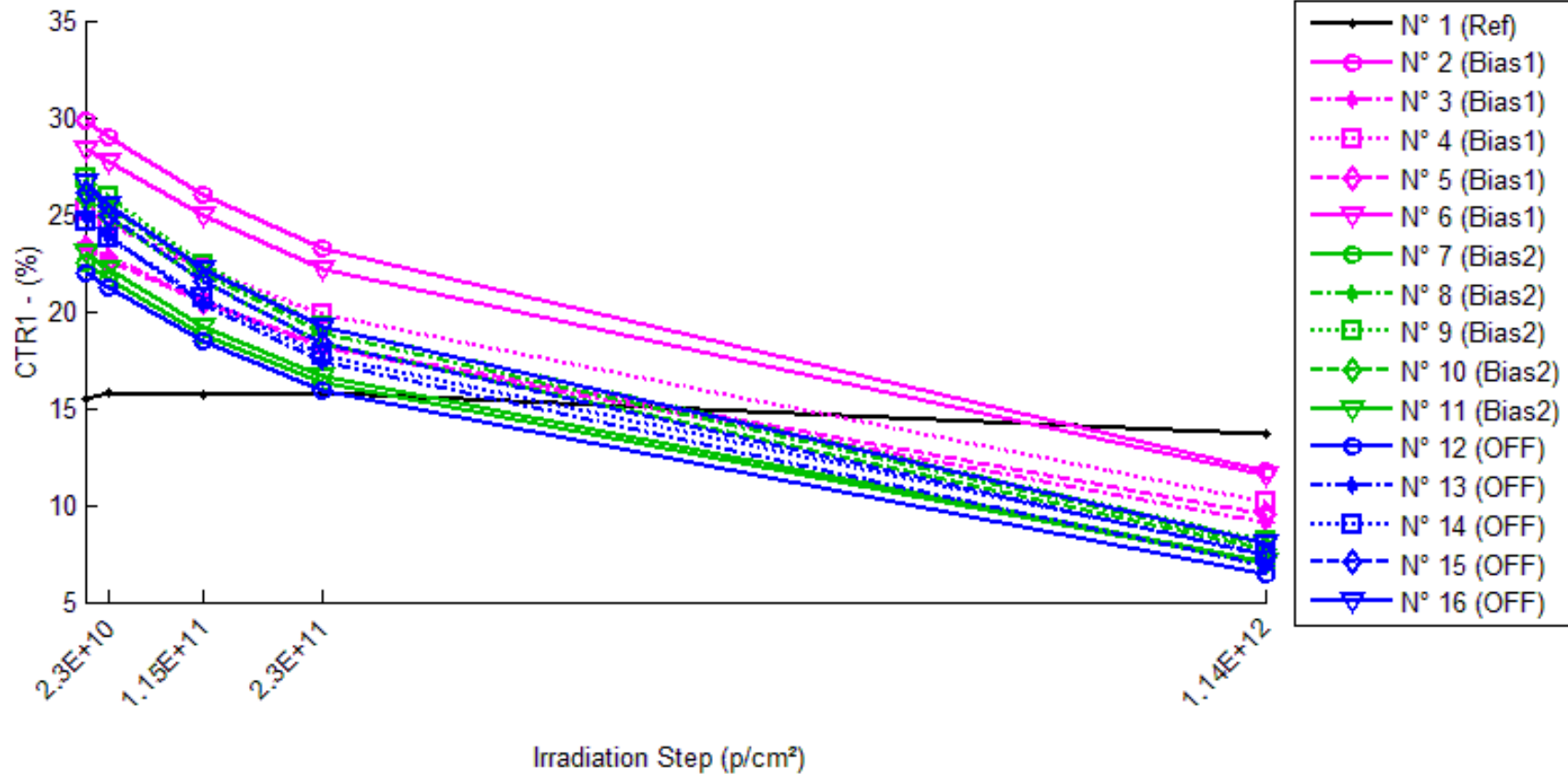

60 MeV proton / detailed results

CTR1 . (%)

	0,p/cm ²	2.3E10,p/cm ²	1.15E11,p/cm ²	2.3E11,p/cm ²	1.14E12,p/cm ²
N° 1 (Ref)	15.51	15.75	15.74	15.78	13.70
N° 2 (Bias1)	29.80	28.99	26.01	23.22	11.76
N° 3 (Bias1)	23.50	22.81	20.45	18.16	9.13
N° 4 (Bias1)	25.16	24.52	22.14	19.84	10.12
N° 5 (Bias1)	23.21	22.61	20.52	18.21	9.51
N° 6 (Bias1)	28.40	27.72	25.00	22.20	11.49
N° 7 (Bias2)	22.47	21.69	18.77	16.28	6.92
N° 8 (Bias2)	26.35	25.37	22.00	18.86	7.95
N° 9 (Bias2)	26.90	25.92	22.36	19.24	8.12
N° 10 (Bias2)	25.79	24.86	21.52	18.38	7.74
N° 11 (Bias2)	23.03	22.16	19.15	16.69	7.10
N° 12 (OFF)	22.02	21.21	18.50	15.95	6.40
N° 13 (OFF)	24.91	23.92	20.42	17.41	6.88
N° 14 (OFF)	24.63	23.75	20.68	17.72	7.46
N° 15 (OFF)	26.17	25.00	21.50	18.37	7.43
N° 16 (OFF)	26.60	25.52	22.22	19.25	8.04

1/Delta [CTR1]

	0,p/cm ²	2.3E10,p/cm ²	1.15E11,p/cm ²	2.3E11,p/cm ²	1.14E12,p/cm ²
N° 1 (Ref)	---	-9.714E-4	-9.231E-4	-1.103E-3	8.510E-3
N° 2 (Bias1)	---	9.304E-4	4.881E-3	9.498E-3	5.144E-2
N° 3 (Bias1)	---	1.296E-3	6.341E-3	1.251E-2	6.695E-2
N° 4 (Bias1)	---	1.035E-3	5.428E-3	1.067E-2	5.906E-2
N° 5 (Bias1)	---	1.140E-3	5.660E-3	1.182E-2	6.208E-2
N° 6 (Bias1)	---	8.647E-4	4.791E-3	9.825E-3	5.185E-2
N° 7 (Bias2)	---	1.591E-3	8.785E-3	1.692E-2	1.000E-1
N° 8 (Bias2)	---	1.468E-3	7.496E-3	1.506E-2	8.781E-2
N° 9 (Bias2)	---	1.403E-3	7.550E-3	1.480E-2	8.595E-2
N° 10 (Bias2)	---	1.464E-3	7.695E-3	1.565E-2	9.038E-2
N° 11 (Bias2)	---	1.687E-3	8.784E-3	1.648E-2	9.733E-2
N° 12 (OFF)	---	1.735E-3	8.642E-3	1.727E-2	1.108E-1
N° 13 (OFF)	---	1.652E-3	8.835E-3	1.730E-2	1.052E-1
N° 14 (OFF)	---	1.507E-3	7.758E-3	1.583E-2	9.342E-2
N° 15 (OFF)	---	1.783E-3	8.306E-3	1.623E-2	9.643E-2
N° 16 (OFF)	---	1.592E-3	7.424E-3	1.436E-2	8.685E-2
Average (OFF)	---	1.053E-3	5.420E-3	1.086E-2	5.828E-2
σ (OFF)	---	1.714E-4	6.307E-4	1.284E-3	6.679E-3
Average+3 σ (OFF)	---	1.567E-3	7.312E-3	1.472E-2	7.831E-2
Average-3 σ (OFF)	---	5.392E-4	3.528E-3	7.013E-3	3.824E-2
Average (Bias1)	---	1.523E-3	8.062E-3	1.578E-2	9.230E-2
σ (Bias1)	---	1.145E-4	6.637E-4	9.074E-4	6.109E-3
Average+3 σ (Bias1)	---	1.866E-3	1.005E-2	1.850E-2	1.106E-1
Average-3 σ (Bias1)	---	1.179E-3	6.071E-3	1.306E-2	7.397E-2
Average (Bias2)	---	1.654E-3	8.193E-3	1.620E-2	9.853E-2
σ (Bias2)	---	1.104E-4	5.932E-4	1.211E-3	9.502E-3
Average+3 σ (Bias2)	---	1.985E-3	9.973E-3	1.983E-2	1.270E-1
Average-3 σ (Bias2)	---	1.323E-3	6.414E-3	1.257E-2	7.002E-2

60 MeV proton / detailed results

10.CTR2

Ta=25°C; Vo=0.4V; If=4mA; Vcc=5V

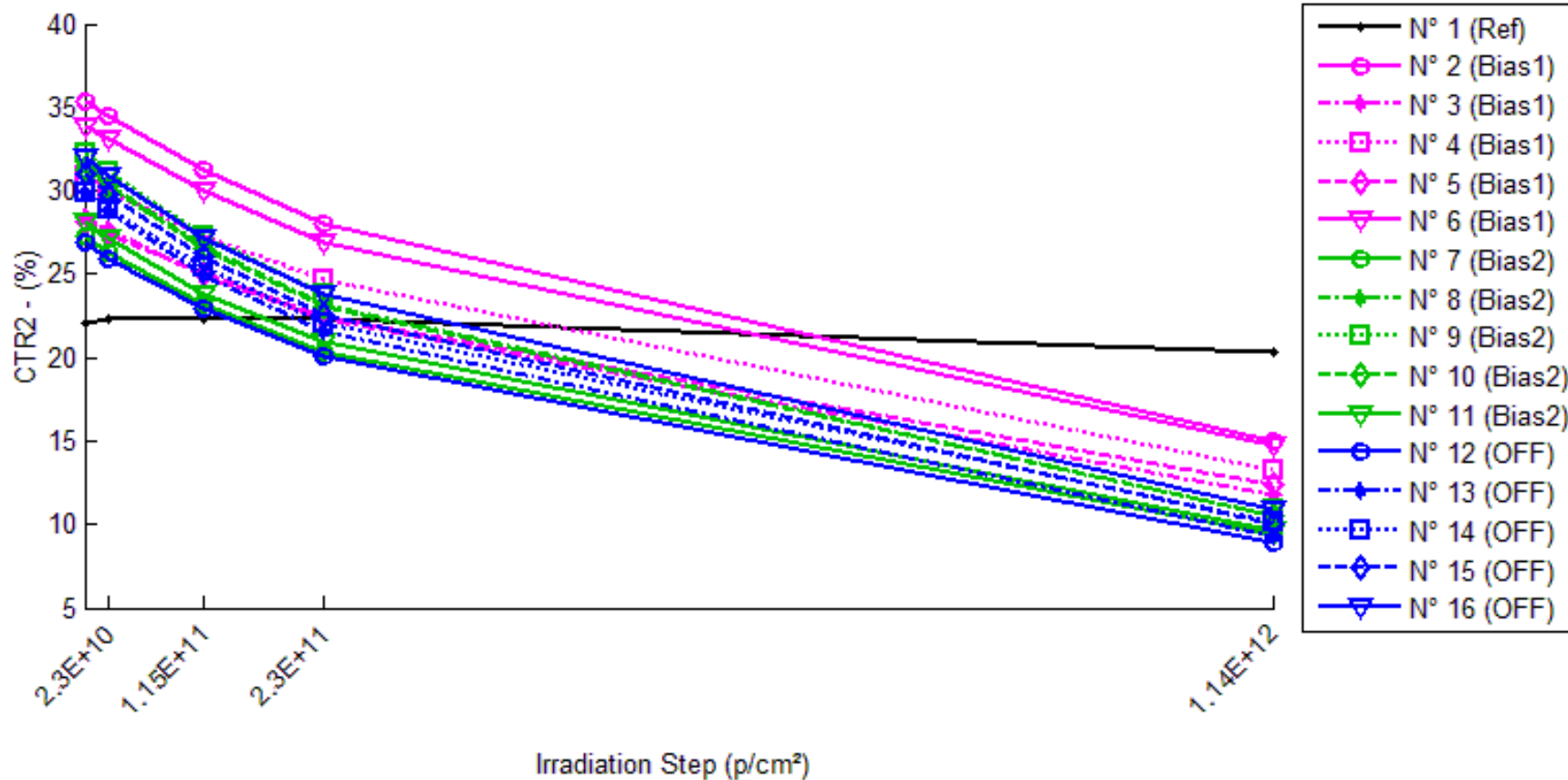

60 MeV proton / detailed results

CTR2 . (%)

	0.p/cm ²	2.3E10.p/cm ²	1.15E11.p/cm ²	2.3E11.p/cm ²	1.14E12.p/cm ²
N° 1 (Ref)	22.08	22.26	22.27	22.32	20.32
N° 2 (Bias1)	35.40	34.45	31.21	28.06	15.05
N° 3 (Bias1)	28.44	27.60	24.96	22.33	11.80
N° 4 (Bias1)	30.85	30.03	27.33	24.66	13.31
N° 5 (Bias1)	28.10	27.38	25.01	22.44	12.33
N° 6 (Bias1)	33.88	33.05	30.04	26.96	14.72
N° 7 (Bias2)	27.24	26.34	23.16	20.36	9.36
N° 8 (Bias2)	31.45	30.33	26.63	23.13	10.53
N° 9 (Bias2)	32.22	31.12	27.26	23.79	10.91
N° 10 (Bias2)	31.30	30.20	26.54	23.02	10.51
N° 11 (Bias2)	28.11	27.10	23.81	20.94	9.63
N° 12 (OFF)	26.92	25.95	22.93	20.05	8.86
N° 13 (OFF)	29.83	28.71	24.86	21.52	9.32
N° 14 (OFF)	29.85	28.83	25.42	22.12	10.16
N° 15 (OFF)	31.01	29.75	26.02	22.57	9.98
N° 16 (OFF)	31.98	30.82	27.21	23.85	10.93

1/Delta [CTR2]

	0.p/cm ²	2.3E10.p/cm ²	1.15E11.p/cm ²	2.3E11.p/cm ²	1.14E12.p/cm ²
N° 1 (Ref)	---	-3.724E-4	-3.945E-4	-4.877E-4	3.926E-3
N° 2 (Bias1)	---	7.724E-4	3.789E-3	7.389E-3	3.818E-2
N° 3 (Bias1)	---	1.068E-3	4.903E-3	9.625E-3	4.959E-2
N° 4 (Bias1)	---	8.774E-4	4.170E-3	8.129E-3	4.272E-2
N° 5 (Bias1)	---	9.252E-4	4.393E-3	8.967E-3	4.550E-2
N° 6 (Bias1)	---	7.356E-4	3.777E-3	7.578E-3	3.840E-2
N° 7 (Bias2)	---	1.251E-3	6.473E-3	1.241E-2	7.017E-2
N° 8 (Bias2)	---	1.179E-3	5.753E-3	1.144E-2	6.317E-2
N° 9 (Bias2)	---	1.098E-3	5.648E-3	1.100E-2	6.064E-2
N° 10 (Bias2)	---	1.159E-3	5.734E-3	1.149E-2	6.320E-2
N° 11 (Bias2)	---	1.324E-3	6.423E-3	1.217E-2	6.822E-2
N° 12 (OFF)	---	1.378E-3	6.455E-3	1.274E-2	7.569E-2
N° 13 (OFF)	---	1.314E-3	6.705E-3	1.296E-2	7.373E-2
N° 14 (OFF)	---	1.186E-3	5.826E-3	1.170E-2	6.491E-2
N° 15 (OFF)	---	1.365E-3	6.192E-3	1.207E-2	6.796E-2
N° 16 (OFF)	---	1.184E-3	5.488E-3	1.067E-2	6.021E-2
Average (OFF)	---	8.758E-4	4.206E-3	8.338E-3	4.288E-2
σ (OFF)	---	1.321E-4	4.691E-4	9.452E-4	4.849E-3
Average+3 σ (OFF)	---	1.272E-3	5.614E-3	1.117E-2	5.742E-2
Average-3 σ (OFF)	---	4.794E-4	2.799E-3	5.502E-3	2.833E-2
Average (Bias1)	---	1.202E-3	6.006E-3	1.170E-2	6.508E-2
σ (Bias1)	---	8.735E-5	4.056E-4	5.773E-4	3.957E-3
Average+3 σ (Bias1)	---	1.464E-3	7.223E-3	1.343E-2	7.695E-2
Average-3 σ (Bias1)	---	9.401E-4	4.789E-3	9.971E-3	5.321E-2
Average (Bias2)	---	1.285E-3	6.133E-3	1.203E-2	6.850E-2
σ (Bias2)	---	9.494E-5	4.860E-4	9.121E-4	6.346E-3
Average+3 σ (Bias2)	---	1.570E-3	7.591E-3	1.476E-2	8.754E-2
Average-3 σ (Bias2)	---	1.001E-3	4.675E-3	9.290E-3	4.946E-2

60 MeV proton / detailed results

11.CTR3

Ta=25°C; Vo=0.4V; If=16mA; Vcc=4.5V

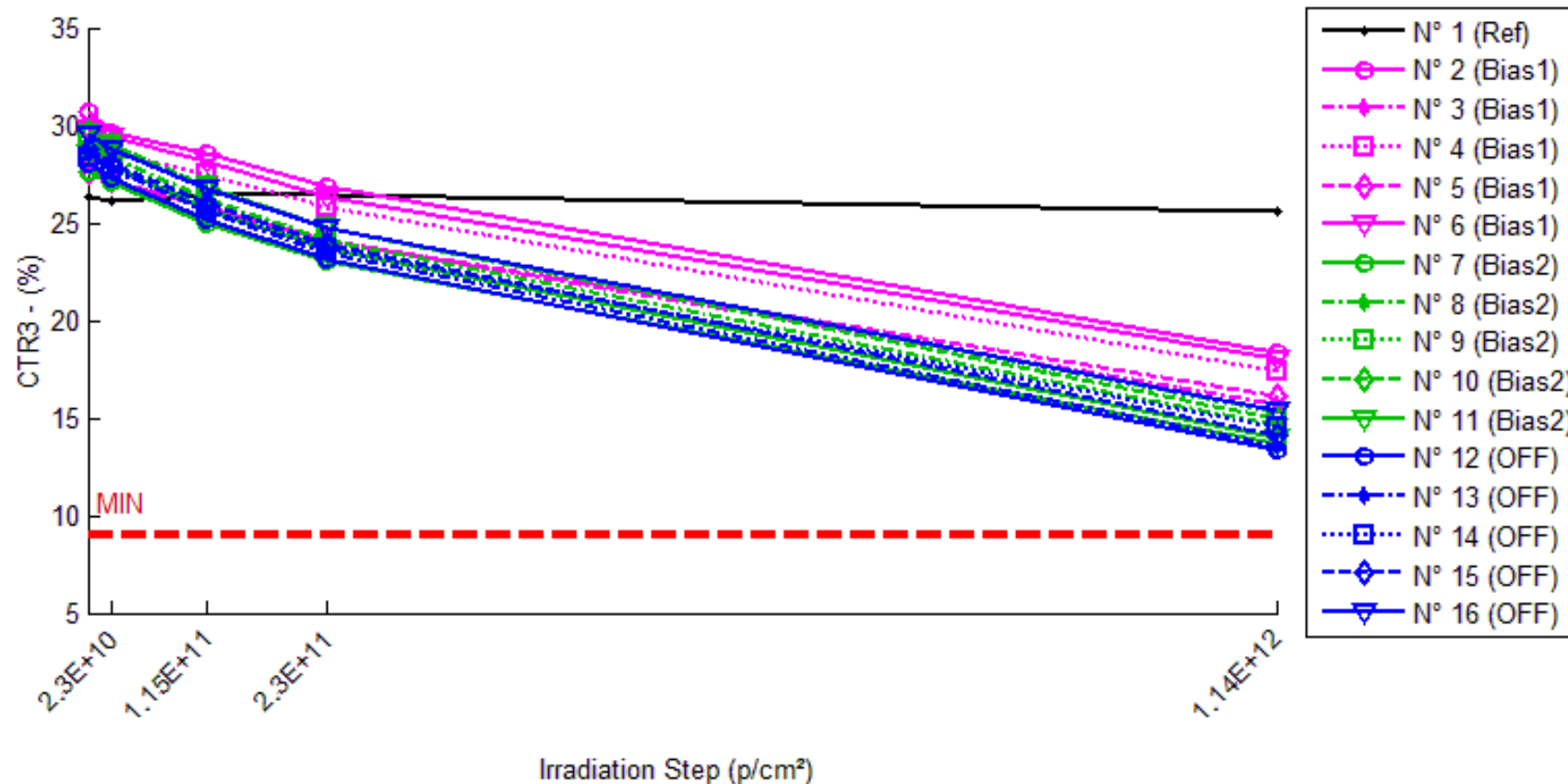

60 MeV proton / detailed results

CTR3 . (%)

Min = 9.0

	0.p/cm ²	2.3E10.p/cm ²	1.15E11.p/cm ²	2.3E11.p/cm ²	1.14E12.p/cm ²
N° 1 (Ref)	26.37	26.11	26.45	26.43	25.55
N° 2 (Bias1)	30.67	29.68	28.60	26.82	18.34
N° 3 (Bias1)	27.98	27.12	25.82	24.05	15.65
N° 4 (Bias1)	29.44	28.59	27.50	25.78	17.39
N° 5 (Bias1)	27.62	27.14	25.83	24.11	16.16
N° 6 (Bias1)	29.87	29.40	28.10	26.28	17.99
N° 7 (Bias2)	27.63	27.04	24.98	23.02	13.64
N° 8 (Bias2)	28.91	28.30	26.22	24.13	14.60
N° 9 (Bias2)	29.55	28.96	26.83	24.76	15.22
N° 10 (Bias2)	29.65	29.04	26.90	24.72	14.96
N° 11 (Bias2)	28.57	27.93	25.74	23.72	14.02
N° 12 (OFF)	27.98	27.30	25.20	23.11	13.34
N° 13 (OFF)	28.55	27.81	25.60	23.44	13.56
N° 14 (OFF)	28.33	27.70	25.74	23.72	14.51
N° 15 (OFF)	28.79	28.04	25.98	23.88	14.13
N° 16 (OFF)	29.49	28.79	26.79	24.78	15.37

1/Delta [CTR3]

	0.p/cm ²	2.3E10.p/cm ²	1.15E11.p/cm ²	2.3E11.p/cm ²	1.14E12.p/cm ²
N° 1 (Ref)	---	3.847E-4	-1.127E-4	-8.564E-5	1.212E-3
N° 2 (Bias1)	---	1.092E-3	2.366E-3	4.681E-3	2.193E-2
N° 3 (Bias1)	---	1.132E-3	2.979E-3	5.836E-3	2.814E-2
N° 4 (Bias1)	---	1.008E-3	2.393E-3	4.823E-3	2.354E-2
N° 5 (Bias1)	---	6.340E-4	2.511E-3	5.269E-3	2.569E-2
N° 6 (Bias1)	---	5.396E-4	2.112E-3	4.572E-3	2.212E-2
N° 7 (Bias2)	---	7.949E-4	3.832E-3	7.244E-3	3.714E-2
N° 8 (Bias2)	---	7.480E-4	3.546E-3	6.862E-3	3.393E-2
N° 9 (Bias2)	---	6.927E-4	3.428E-3	6.551E-3	3.186E-2
N° 10 (Bias2)	---	7.109E-4	3.450E-3	6.716E-3	3.311E-2
N° 11 (Bias2)	---	7.947E-4	3.843E-3	7.152E-3	3.631E-2
N° 12 (OFF)	---	8.898E-4	3.936E-3	7.527E-3	3.924E-2
N° 13 (OFF)	---	9.328E-4	4.038E-3	7.640E-3	3.872E-2
N° 14 (OFF)	---	8.065E-4	3.546E-3	6.865E-3	3.362E-2
N° 15 (OFF)	---	9.234E-4	3.760E-3	7.136E-3	3.604E-2
N° 16 (OFF)	---	8.175E-4	3.406E-3	6.437E-3	3.115E-2
Average (OFF)	---	8.812E-4	2.472E-3	5.036E-3	2.428E-2
σ (OFF)	---	2.745E-4	3.186E-4	5.201E-4	2.626E-3
Average+3 σ (OFF)	---	1.705E-3	3.428E-3	6.596E-3	3.216E-2
Average-3 σ (OFF)	---	5.778E-5	1.516E-3	3.476E-3	1.641E-2
Average (Bias1)	---	7.482E-4	3.620E-3	6.905E-3	3.447E-2
σ (Bias1)	---	4.696E-5	2.039E-4	2.912E-4	2.208E-3
Average+3 σ (Bias1)	---	8.891E-4	4.231E-3	7.779E-3	4.109E-2
Average-3 σ (Bias1)	---	6.074E-4	3.008E-3	6.031E-3	2.785E-2
Average (Bias2)	---	8.740E-4	3.737E-3	7.121E-3	3.575E-2
σ (Bias2)	---	5.894E-5	2.630E-4	4.920E-4	3.419E-3
Average+3 σ (Bias2)	---	1.051E-3	4.526E-3	8.597E-3	4.601E-2
Average-3 σ (Bias2)	---	6.972E-4	2.948E-3	5.645E-3	2.549E-2

60 MeV proton / detailed results

12.CTR4

Ta=25°C; Vo=0.4V; If=20mA; Vcc=5V

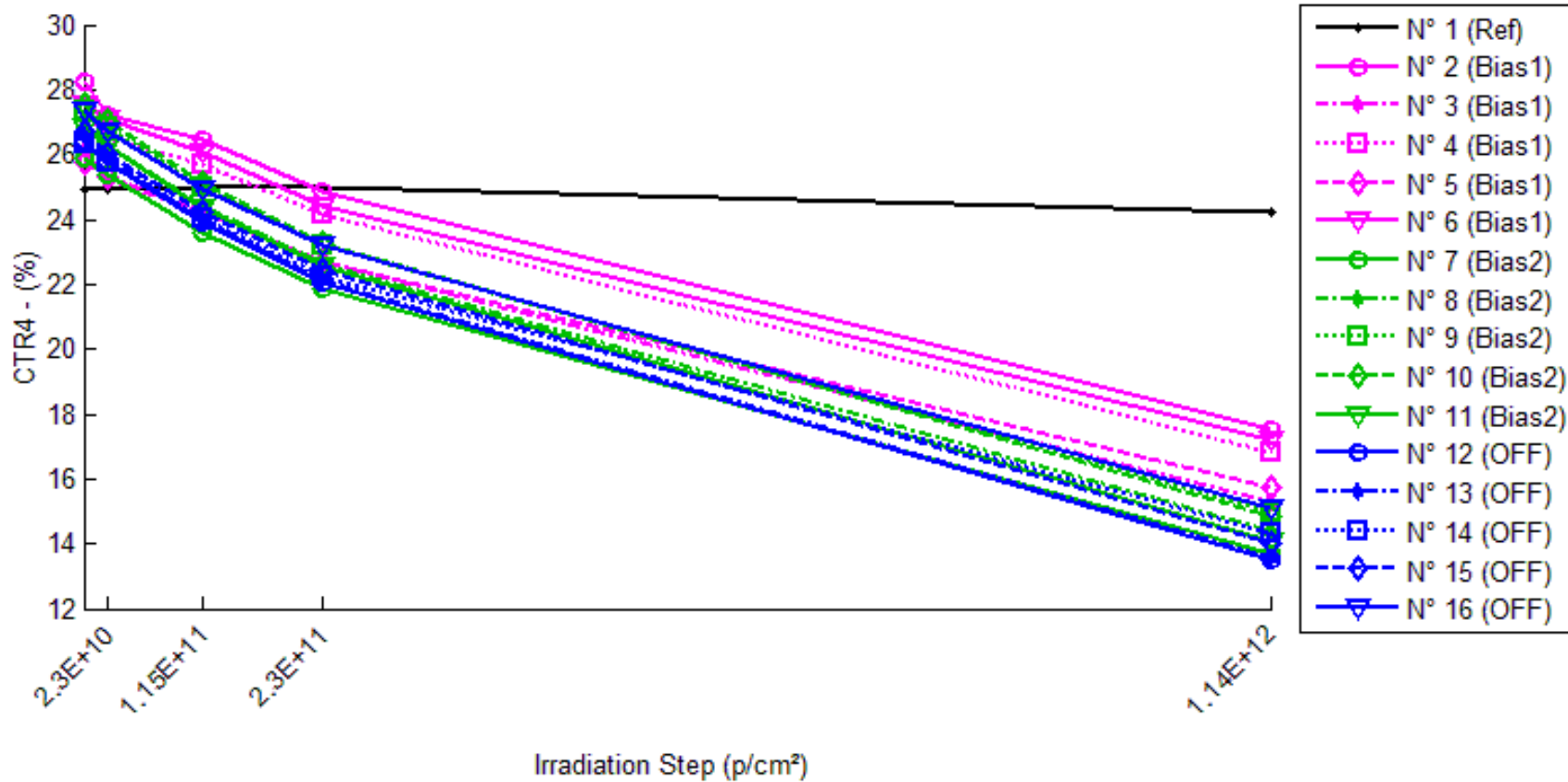

60 MeV proton / detailed results

CTR4 . (%)

	0.p/cm ²	2.3E10.p/cm ²	1.15E11.p/cm ²	2.3E11.p/cm ²	1.14E12.p/cm ²
N° 1 (Ref)	24.95	24.90	25.01	24.98	24.24
N° 2 (Bias1)	28.23	27.20	26.43	24.87	17.51
N° 3 (Bias1)	26.13	25.27	24.25	22.68	15.31
N° 4 (Bias1)	27.35	26.49	25.67	24.15	16.81
N° 5 (Bias1)	25.77	25.33	24.24	22.71	15.72
N° 6 (Bias1)	27.54	27.11	26.05	24.44	17.18
N° 7 (Bias2)	25.91	25.38	23.58	21.85	13.70
N° 8 (Bias2)	26.79	26.25	24.42	22.60	14.41
N° 9 (Bias2)	27.37	26.85	24.98	23.18	14.99
N° 10 (Bias2)	27.55	27.01	25.13	23.24	14.82
N° 11 (Bias2)	26.81	26.25	24.32	22.54	14.08
N° 12 (OFF)	26.38	25.76	23.91	22.06	13.47
N° 13 (OFF)	26.57	25.90	23.99	22.10	13.58
N° 14 (OFF)	26.31	25.74	24.03	22.26	14.33
N° 15 (OFF)	26.70	26.02	24.24	22.42	14.04
N° 16 (OFF)	27.32	26.69	24.94	23.19	15.10

1/Delta [CTR4]

	0.p/cm ²	2.3E10.p/cm ²	1.15E11.p/cm ²	2.3E11.p/cm ²	1.14E12.p/cm ²
N° 1 (Ref)	---	6.725E-5	-1.043E-4	-4.983E-5	1.162E-3
N° 2 (Bias1)	---	1.339E-3	2.414E-3	4.797E-3	2.170E-2
N° 3 (Bias1)	---	1.304E-3	2.966E-3	5.812E-3	2.706E-2
N° 4 (Bias1)	---	1.194E-3	2.396E-3	4.847E-3	2.294E-2
N° 5 (Bias1)	---	6.686E-4	2.450E-3	5.217E-3	2.479E-2
N° 6 (Bias1)	---	5.745E-4	2.078E-3	4.607E-3	2.189E-2
N° 7 (Bias2)	---	8.085E-4	3.815E-3	7.170E-3	3.441E-2
N° 8 (Bias2)	---	7.691E-4	3.616E-3	6.920E-3	3.206E-2
N° 9 (Bias2)	---	7.153E-4	3.492E-3	6.607E-3	3.019E-2
N° 10 (Bias2)	---	7.307E-4	3.492E-3	6.736E-3	3.119E-2
N° 11 (Bias2)	---	7.939E-4	3.817E-3	7.070E-3	3.373E-2
N° 12 (OFF)	---	9.023E-4	3.917E-3	7.421E-3	3.634E-2
N° 13 (OFF)	---	9.823E-4	4.057E-3	7.627E-3	3.602E-2
N° 14 (OFF)	---	8.488E-4	3.603E-3	6.916E-3	3.176E-2
N° 15 (OFF)	---	9.676E-4	3.790E-3	7.151E-3	3.378E-2
N° 16 (OFF)	---	8.633E-4	3.491E-3	6.526E-3	2.964E-2
Average (OFF)	---	1.016E-3	2.461E-3	5.056E-3	2.368E-2
σ (OFF)	---	3.657E-4	3.192E-4	4.771E-4	2.254E-3
Average+3 σ (OFF)	---	2.113E-3	3.419E-3	6.487E-3	3.044E-2
Average-3 σ (OFF)	---	-8.091E-5	1.503E-3	3.624E-3	1.692E-2
Average (Bias1)	---	7.635E-4	3.646E-3	6.901E-3	3.232E-2
σ (Bias1)	---	3.991E-5	1.630E-4	2.316E-4	1.751E-3
Average+3 σ (Bias1)	---	8.833E-4	4.135E-3	7.595E-3	3.757E-2
Average-3 σ (Bias1)	---	6.438E-4	3.157E-3	6.206E-3	2.706E-2
Average (Bias2)	---	9.129E-4	3.771E-3	7.128E-3	3.351E-2
σ (Bias2)	---	6.020E-5	2.293E-4	4.309E-4	2.846E-3
Average+3 σ (Bias2)	---	1.093E-3	4.459E-3	8.421E-3	4.205E-2
Average-3 σ (Bias2)	---	7.323E-4	3.084E-3	5.835E-3	2.497E-2

60 MeV proton / detailed results

13.CTR5

Ta=25°C; Vo=0.4V; If=40mA; Vcc=5V

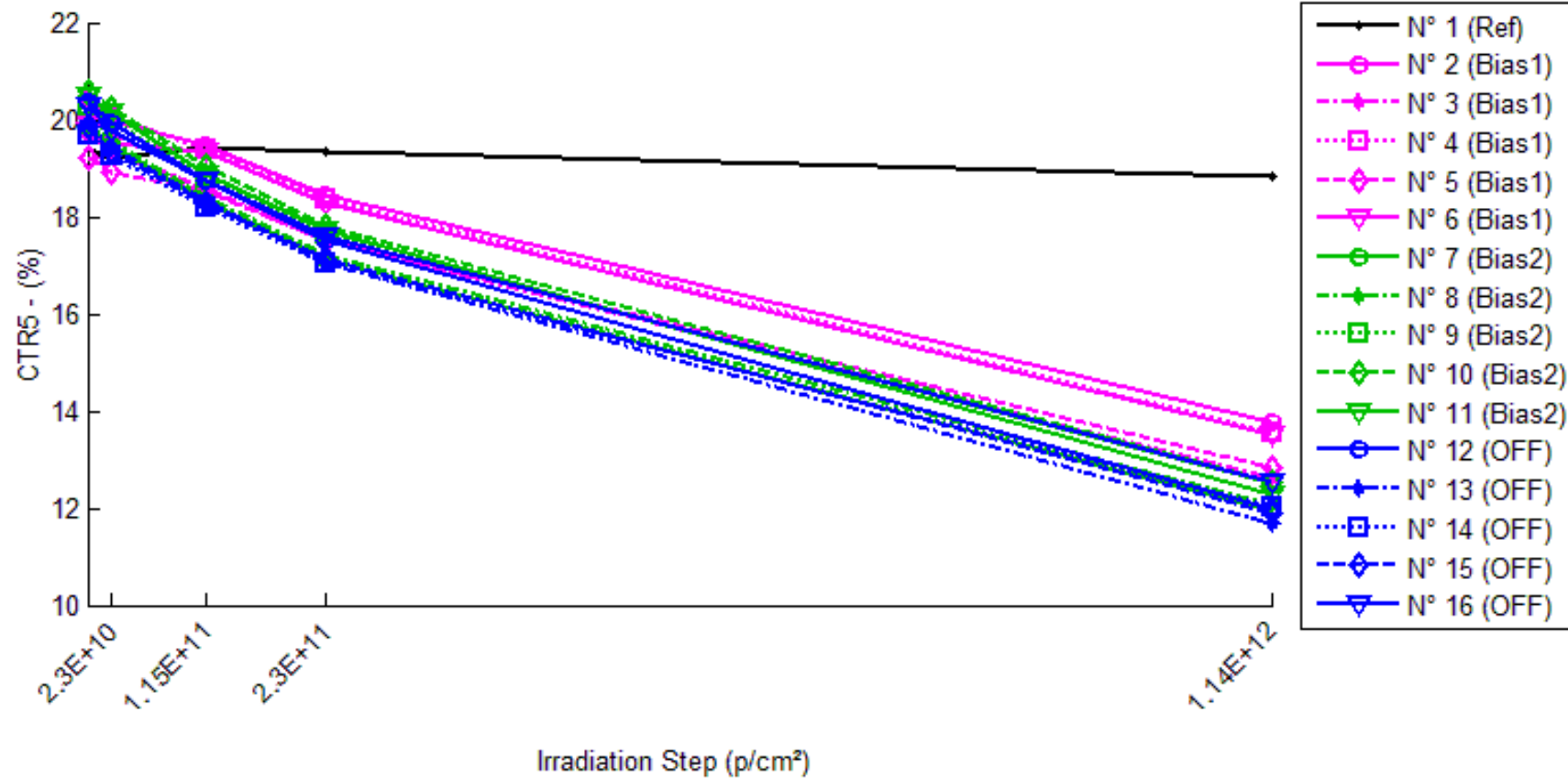

60 MeV proton / detailed results

CTR5 . (%)

	0.p/cm ²	2.3E10.p/cm ²	1.15E11.p/cm ²	2.3E11.p/cm ²	1.14E12.p/cm ²
N° 1 (Ref)	19.39	19.22	19.41	19.32	18.81
N° 2 (Bias1)	20.39	20.00	19.48	18.46	13.75
N° 3 (Bias1)	19.64	19.35	18.58	17.53	12.63
N° 4 (Bias1)	20.21	20.07	19.39	18.37	13.55
N° 5 (Bias1)	19.23	18.90	18.54	17.49	12.83
N° 6 (Bias1)	19.78	19.50	19.35	18.27	13.50
N° 7 (Bias2)	19.83	19.47	18.30	17.13	11.95
N° 8 (Bias2)	19.88	19.55	18.40	17.20	12.06
N° 9 (Bias2)	20.29	19.96	18.80	17.63	12.48
N° 10 (Bias2)	20.56	20.22	19.05	17.82	12.52
N° 11 (Bias2)	20.50	20.14	18.89	17.71	12.29
N° 12 (OFF)	20.38	19.92	18.76	17.53	11.96
N° 13 (OFF)	19.95	19.42	18.30	17.06	11.69
N° 14 (OFF)	19.67	19.24	18.19	17.04	12.03
N° 15 (OFF)	19.84	19.35	18.29	17.13	11.88
N° 16 (OFF)	20.27	19.78	18.75	17.61	12.53

1/Delta [CTR5]

	0.p/cm ²	2.3E10.p/cm ²	1.15E11.p/cm ²	2.3E11.p/cm ²	1.14E12.p/cm ²
N° 1 (Ref)	---	4.582E-4	-5.891E-5	1.755E-4	1.598E-3
N° 2 (Bias1)	---	9.600E-4	2.314E-3	5.151E-3	2.369E-2
N° 3 (Bias1)	---	7.652E-4	2.919E-3	6.119E-3	2.825E-2
N° 4 (Bias1)	---	3.554E-4	2.092E-3	4.972E-3	2.432E-2
N° 5 (Bias1)	---	9.105E-4	1.949E-3	5.168E-3	2.594E-2
N° 6 (Bias1)	---	7.371E-4	1.123E-3	4.195E-3	2.351E-2
N° 7 (Bias2)	---	9.209E-4	4.203E-3	7.928E-3	3.326E-2
N° 8 (Bias2)	---	8.495E-4	4.056E-3	7.839E-3	3.262E-2
N° 9 (Bias2)	---	8.061E-4	3.903E-3	7.452E-3	3.082E-2
N° 10 (Bias2)	---	8.070E-4	3.852E-3	7.460E-3	3.125E-2
N° 11 (Bias2)	---	8.632E-4	4.148E-3	7.696E-3	3.257E-2
N° 12 (OFF)	---	1.133E-3	4.232E-3	7.957E-3	3.454E-2
N° 13 (OFF)	---	1.393E-3	4.525E-3	8.486E-3	3.541E-2
N° 14 (OFF)	---	1.147E-3	4.145E-3	7.860E-3	3.232E-2
N° 15 (OFF)	---	1.277E-3	4.260E-3	7.982E-3	3.375E-2
N° 16 (OFF)	---	1.225E-3	4.023E-3	7.465E-3	3.049E-2
Average (OFF)	---	7.456E-4	2.079E-3	5.121E-3	2.514E-2
σ (OFF)	---	2.376E-4	6.507E-4	6.854E-4	1.987E-3
Average+3 σ (OFF)	---	1.459E-3	4.031E-3	7.177E-3	3.110E-2
Average-3 σ (OFF)	---	3.272E-5	1.273E-4	3.065E-3	1.918E-2
Average (Bias1)	---	8.494E-4	4.032E-3	7.675E-3	3.210E-2
σ (Bias1)	---	4.737E-5	1.519E-4	2.163E-4	1.022E-3
Average+3 σ (Bias1)	---	9.915E-4	4.488E-3	8.324E-3	3.517E-2
Average-3 σ (Bias1)	---	7.072E-4	3.577E-3	7.026E-3	2.904E-2
Average (Bias2)	---	1.235E-3	4.237E-3	7.950E-3	3.330E-2
σ (Bias2)	---	1.058E-4	1.856E-4	3.649E-4	1.940E-3
Average+3 σ (Bias2)	---	1.553E-3	4.794E-3	9.045E-3	3.912E-2
Average-3 σ (Bias2)	---	9.178E-4	3.680E-3	6.855E-3	2.748E-2

60 MeV proton / detailed results

14.CTR6

Ta=25°C; Vo=0.4V; If=20mA; Vcc=18V

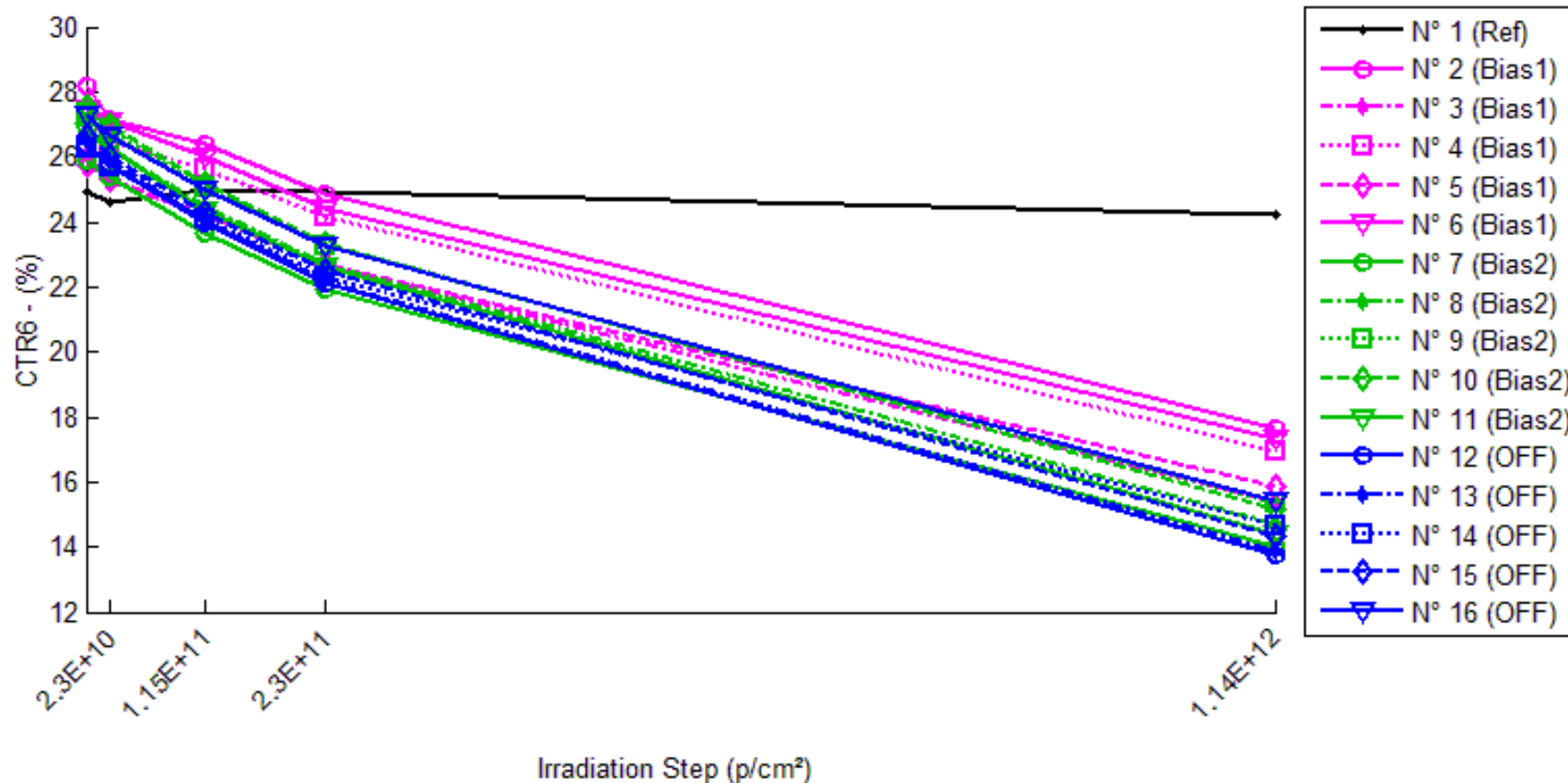

60 MeV proton / detailed results

CTR6 . (%)

	0.p/cm ²	2.3E10.p/cm ²	1.15E11.p/cm ²	2.3E11.p/cm ²	1.14E12.p/cm ²
N° 1 (Ref)	24.92	24.58	24.98	24.95	24.23
N° 2 (Bias1)	28.20	27.17	26.41	24.86	17.64
N° 3 (Bias1)	26.10	25.24	24.23	22.68	15.43
N° 4 (Bias1)	27.32	26.46	25.65	24.15	16.93
N° 5 (Bias1)	25.73	25.30	24.21	22.71	15.84
N° 6 (Bias1)	27.51	27.08	26.03	24.44	17.31
N° 7 (Bias2)	25.88	25.37	23.63	21.93	14.01
N° 8 (Bias2)	26.75	26.24	24.47	22.68	14.72
N° 9 (Bias2)	27.34	26.84	25.04	23.26	15.32
N° 10 (Bias2)	27.52	27.00	25.19	23.32	15.15
N° 11 (Bias2)	26.78	26.24	24.38	22.62	14.38
N° 12 (OFF)	26.35	25.76	23.96	22.14	13.77
N° 13 (OFF)	26.54	25.89	24.04	22.17	13.88
N° 14 (OFF)	26.28	25.72	24.08	22.34	14.63
N° 15 (OFF)	26.66	26.01	24.29	22.49	14.34
N° 16 (OFF)	27.29	26.68	25.00	23.26	15.42

1/Delta [CTR6]

	0.p/cm ²	2.3E10.p/cm ²	1.15E11.p/cm ²	2.3E11.p/cm ²	1.14E12.p/cm ²
N° 1 (Ref)	---	5.595E-4	-9.558E-5	-4.307E-5	1.149E-3
N° 2 (Bias1)	---	1.344E-3	2.406E-3	4.764E-3	2.124E-2
N° 3 (Bias1)	---	1.305E-3	2.952E-3	5.768E-3	2.649E-2
N° 4 (Bias1)	---	1.198E-3	2.387E-3	4.809E-3	2.247E-2
N° 5 (Bias1)	---	6.703E-4	2.438E-3	5.175E-3	2.429E-2
N° 6 (Bias1)	---	5.776E-4	2.063E-3	4.565E-3	2.141E-2
N° 7 (Bias2)	---	7.809E-4	3.675E-3	6.961E-3	3.274E-2
N° 8 (Bias2)	---	7.390E-4	3.484E-3	6.711E-3	3.055E-2
N° 9 (Bias2)	---	6.855E-4	3.356E-3	6.408E-3	2.871E-2
N° 10 (Bias2)	---	7.011E-4	3.362E-3	6.540E-3	2.968E-2
N° 11 (Bias2)	---	7.661E-4	3.684E-3	6.870E-3	3.218E-2
N° 12 (OFF)	---	8.703E-4	3.785E-3	7.218E-3	3.468E-2
N° 13 (OFF)	---	9.549E-4	3.920E-3	7.426E-3	3.435E-2
N° 14 (OFF)	---	8.180E-4	3.474E-3	6.717E-3	3.030E-2
N° 15 (OFF)	---	9.369E-4	3.660E-3	6.953E-3	3.220E-2
N° 16 (OFF)	---	8.318E-4	3.358E-3	6.343E-3	2.822E-2
Average (OFF)	---	1.019E-3	2.449E-3	5.016E-3	2.318E-2
σ (OFF)	---	3.659E-4	3.193E-4	4.744E-4	2.212E-3
Average+3σ (OFF)	---	2.117E-3	3.407E-3	6.440E-3	2.981E-2
Average-3σ (OFF)	---	-7.876E-5	1.491E-3	3.593E-3	1.654E-2
Average (Bias1)	---	7.345E-4	3.512E-3	6.698E-3	3.077E-2
σ (Bias1)	---	4.089E-5	1.612E-4	2.278E-4	1.687E-3
Average+3σ (Bias1)	---	8.572E-4	3.996E-3	7.382E-3	3.583E-2
Average-3σ (Bias1)	---	6.119E-4	3.029E-3	6.015E-3	2.571E-2
Average (Bias2)	---	8.824E-4	3.640E-3	6.931E-3	3.195E-2
σ (Bias2)	---	6.142E-5	2.275E-4	4.238E-4	2.733E-3
Average+3σ (Bias2)	---	1.067E-3	4.322E-3	8.203E-3	4.015E-2
Average-3σ (Bias2)	---	6.981E-4	2.957E-3	5.600E-3	2.375E-2

190 MeV proton / detailed results

CONTENTS

1. IOH	2
2. IOLeak	4
3. VF	6
4. BVr	8
5. ICCH.....	10
6. ICCL	12
7. TPLH	14
8. TPHL	16
9. CTR1	18
10. CTR2	20
11. CTR3	22
12. CTR4	24
13. CTR5	26
14. CTR6	28

190 MeV proton / detailed results

1. IOH

Ta=25°C; If=0; Vo=Vcc=18V



190 MeV proton / detailed results

IOH . (µA) Max = 100.0

	0.p/cm ²	4E10.p/cm ²	2E11.p/cm ²	4E11.p/cm ²	1.91E12.p/cm ²
N° 1 (Ref)	0.0019	0.0020	0.0021	0.0031	0.0021
N° 2 (Bias1)	0.0024	0.0023	0.0030	0.0035	0.0034
N° 3 (Bias1)	0.0023	0.0023	0.0034	0.0032	0.0033
N° 4 (Bias1)	0.0024	0.0027	0.0035	0.0035	0.0035
N° 5 (Bias1)	0.0024	0.0025	0.0034	0.0034	0.0036
N° 6 (Bias1)	0.0025	0.0027	0.0035	0.0035	0.0037
N° 7 (Bias2)	0.0023	0.0033	0.0030	0.0028	0.0028
N° 8 (Bias2)	0.0023	0.0034	0.0029	0.0030	0.0026
N° 9 (Bias2)	0.0025	0.0035	0.0031	0.0034	0.0030
N° 10 (Bias2)	0.0024	0.0034	0.0030	0.0033	0.0030
N° 11 (Bias2)	0.0024	0.0038	0.0032	0.0033	0.0031
N° 12 (OFF)	0.0026	0.0030	0.0030	0.0029	0.0030
N° 13 (OFF)	0.0024	0.0030	0.0029	0.0032	0.0030
N° 14 (OFF)	0.0024	0.0029	0.0029	0.0031	0.0029
N° 15 (OFF)	0.0023	0.0028	0.0028	0.0031	0.0032
N° 16 (OFF)	0.0025	0.0029	0.0027	0.0030	0.0034

Delta [IOH]

	0.p/cm ²	4E10.p/cm ²	2E11.p/cm ²	4E11.p/cm ²	1.91E12.p/cm ²
N° 1 (Ref)	---	1.575E-4	2.636E-4	1.214E-3	1.702E-4
N° 2 (Bias1)	---	-6.924E-5	5.887E-4	1.079E-3	1.057E-3
N° 3 (Bias1)	---	-4.870E-5	1.064E-3	9.025E-4	1.000E-3
N° 4 (Bias1)	---	3.372E-4	1.098E-3	1.126E-3	1.104E-3
N° 5 (Bias1)	---	1.339E-4	1.050E-3	9.831E-4	1.256E-3
N° 6 (Bias1)	---	2.280E-4	1.056E-3	1.069E-3	1.245E-3
N° 7 (Bias2)	---	9.982E-4	7.133E-4	5.185E-4	4.408E-4
N° 8 (Bias2)	---	1.079E-3	5.582E-4	6.422E-4	2.977E-4
N° 9 (Bias2)	---	9.503E-4	6.006E-4	8.503E-4	4.644E-4
N° 10 (Bias2)	---	1.047E-3	6.256E-4	8.949E-4	5.853E-4
N° 11 (Bias2)	---	1.330E-3	8.210E-4	8.767E-4	7.011E-4
N° 12 (OFF)	---	3.686E-4	3.814E-4	2.656E-4	4.270E-4
N° 13 (OFF)	---	5.352E-4	4.886E-4	7.284E-4	5.670E-4
N° 14 (OFF)	---	4.634E-4	4.467E-4	6.667E-4	5.352E-4
N° 15 (OFF)	---	4.886E-4	4.490E-4	7.687E-4	8.540E-4
N° 16 (OFF)	---	4.411E-4	2.326E-4	5.402E-4	8.678E-4
Average (Bias1)	---	1.162E-4	9.714E-4	1.032E-3	1.132E-3
σ (Bias1)	---	1.755E-4	2.147E-4	8.883E-5	1.141E-4
Average+3σ (Bias1)	---	6.428E-4	1.616E-3	1.298E-3	1.475E-3
Average-3σ (Bias1)	---	-4.103E-4	3.272E-4	7.654E-4	7.902E-4
Average (Bias2)	---	1.081E-3	6.637E-4	7.565E-4	4.979E-4
σ (Bias2)	---	1.476E-4	1.046E-4	1.674E-4	1.528E-4
Average+3σ (Bias2)	---	1.524E-3	9.775E-4	1.259E-3	9.562E-4
Average-3σ (Bias2)	---	6.382E-4	3.500E-4	2.543E-4	3.950E-5
Average (OFF)	---	4.594E-4	3.997E-4	5.939E-4	6.502E-4
σ (OFF)	---	6.165E-5	1.010E-4	2.028E-4	1.993E-4
Average+3σ (OFF)	---	6.443E-4	7.026E-4	1.202E-3	1.248E-3
Average-3σ (OFF)	---	2.744E-4	9.671E-5	-1.462E-5	5.243E-5

190 MeV proton / detailed results

2. IOLeak

Ta=25°C; If=250µA; Vo=Vcc=18V

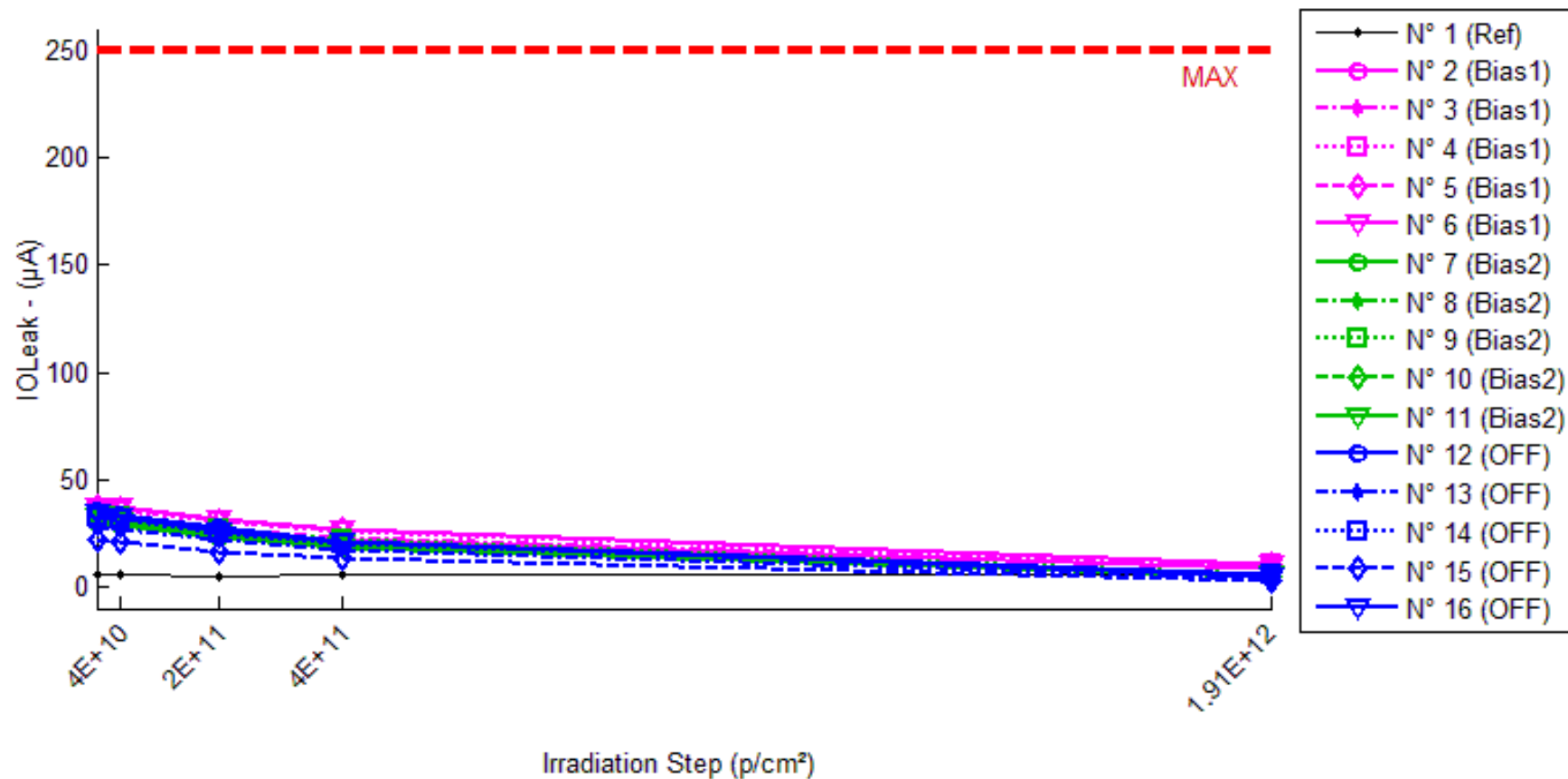

190 MeV proton / detailed results

IOLeak . (µA)

Max = 250.0

	0.p/cm ²	4E10.p/cm ²	2E11.p/cm ²	4E11.p/cm ²	1.91E12.p/cm ²
N° 1 (Ref)	5.658	5.571	5.239	5.395	5.372
N° 2 (Bias1)	30.414	29.318	25.141	21.640	8.667
N° 3 (Bias1)	32.859	31.490	27.297	23.027	9.158
N° 4 (Bias1)	35.956	35.150	30.374	25.963	10.699
N° 5 (Bias1)	37.305	36.071	31.116	26.596	10.412
N° 6 (Bias1)	37.778	37.005	31.752	27.288	10.810
N° 7 (Bias2)	29.740	28.415	23.464	17.974	4.945
N° 8 (Bias2)	30.582	29.045	23.035	18.412	4.633
N° 9 (Bias2)	33.814	32.246	26.612	21.770	5.936
N° 10 (Bias2)	32.813	30.520	24.788	20.037	5.079
N° 11 (Bias2)	32.185	30.483	24.866	20.022	5.541
N° 12 (OFF)	35.439	33.959	27.697	21.572	5.536
N° 13 (OFF)	28.192	26.757	21.689	17.331	4.111
N° 14 (OFF)	32.914	31.288	25.081	20.616	5.384
N° 15 (OFF)	22.136	21.143	16.707	13.256	3.194
N° 16 (OFF)	34.143	32.724	25.689	20.894	5.130

Delta [IOLeak]

	0.p/cm ²	4E10.p/cm ²	2E11.p/cm ²	4E11.p/cm ²	1.91E12.p/cm ²
N° 1 (Ref)	---	-8.682E-2	-4.192E-1	-2.627E-1	-2.861E-1
N° 2 (Bias1)	---	-1.097E+0	-5.274E+0	-8.774E+0	-2.175E+1
N° 3 (Bias1)	---	-1.369E+0	-5.562E+0	-9.832E+0	-2.370E+1
N° 4 (Bias1)	---	-8.059E-1	-5.582E+0	-9.994E+0	-2.526E+1
N° 5 (Bias1)	---	-1.235E+0	-6.190E+0	-1.071E+1	-2.689E+1
N° 6 (Bias1)	---	-7.736E-1	-6.026E+0	-1.049E+1	-2.697E+1
N° 7 (Bias2)	---	-1.325E+0	-6.276E+0	-1.177E+1	-2.479E+1
N° 8 (Bias2)	---	-1.537E+0	-7.547E+0	-1.217E+1	-2.595E+1
N° 9 (Bias2)	---	-1.568E+0	-7.202E+0	-1.204E+1	-2.788E+1
N° 10 (Bias2)	---	-2.293E+0	-8.024E+0	-1.278E+1	-2.773E+1
N° 11 (Bias2)	---	-1.702E+0	-7.318E+0	-1.216E+1	-2.664E+1
N° 12 (OFF)	---	-1.480E+0	-7.743E+0	-1.387E+1	-2.990E+1
N° 13 (OFF)	---	-1.435E+0	-6.503E+0	-1.086E+1	-2.408E+1
N° 14 (OFF)	---	-1.626E+0	-7.834E+0	-1.230E+1	-2.753E+1
N° 15 (OFF)	---	-9.937E-1	-5.429E+0	-8.881E+0	-1.894E+1
N° 16 (OFF)	---	-1.419E+0	-8.453E+0	-1.325E+1	-2.901E+1
Average (Bias1)	---	-1.056E+0	-5.727E+0	-9.960E+0	-2.491E+1
σ (Bias1)	---	2.618E-1	3.733E-1	7.528E-1	2.222E+0
Average+3σ (Bias1)	---	-2.707E-1	-4.607E+0	-7.702E+0	-1.825E+1
Average-3σ (Bias1)	---	-1.842E+0	-6.847E+0	-1.222E+1	-3.158E+1
Average (Bias2)	---	-1.685E+0	-7.274E+0	-1.218E+1	-2.660E+1
σ (Bias2)	---	3.658E-1	6.404E-1	3.692E-1	1.285E+0
Average+3σ (Bias2)	---	-5.875E-1	-5.352E+0	-1.108E+1	-2.275E+1
Average-3σ (Bias2)	---	-2.783E+0	-9.195E+0	-1.329E+1	-3.045E+1
Average (OFF)	---	-1.391E+0	-7.192E+0	-1.183E+1	-2.589E+1
σ (OFF)	---	2.364E-1	1.213E+0	2.001E+0	4.474E+0
Average+3σ (OFF)	---	-6.814E-1	-3.553E+0	-5.828E+0	-1.247E+1
Average-3σ (OFF)	---	-2.100E+0	-1.083E+1	-1.783E+1	-3.932E+1

190 MeV proton / detailed results

3. VF

Ta = 25°C ; If = 20mA

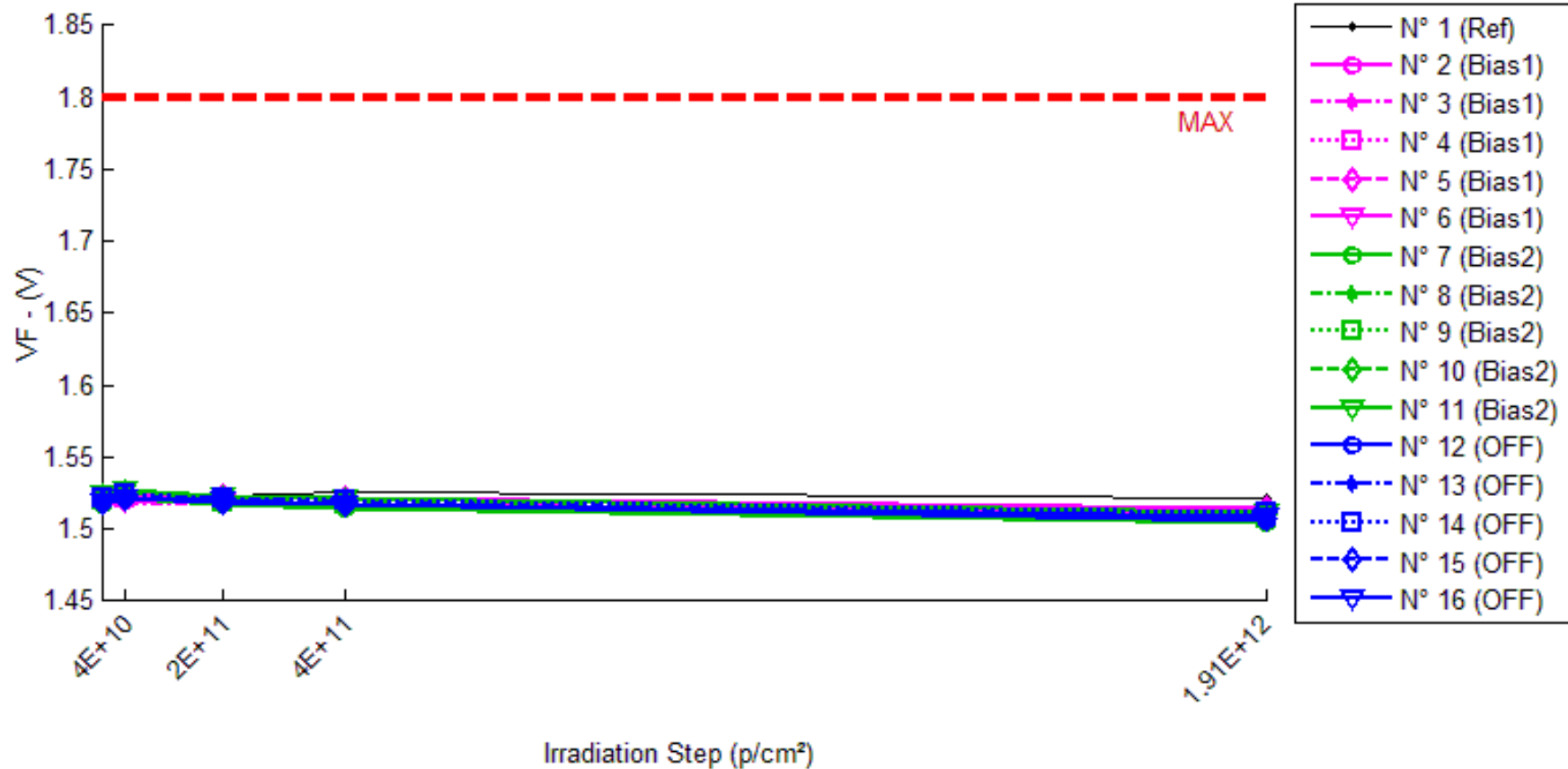

190 MeV proton / detailed results

VF . (V) Max = 1.8

	0,p/cm ²	4E10,p/cm ²	2E11,p/cm ²	4E11,p/cm ²	1.91E12,p/cm ²
N° 1 (Ref)	1.522	1.522	1.523	1.526	1.521
N° 2 (Bias1)	1.523	1.524	1.523	1.521	1.514
N° 3 (Bias1)	1.517	1.518	1.518	1.516	1.508
N° 4 (Bias1)	1.520	1.521	1.520	1.518	1.512
N° 5 (Bias1)	1.523	1.524	1.523	1.522	1.515
N° 6 (Bias1)	1.519	1.520	1.519	1.518	1.511
N° 7 (Bias2)	1.518	1.521	1.517	1.515	1.505
N° 8 (Bias2)	1.523	1.526	1.523	1.521	1.511
N° 9 (Bias2)	1.520	1.524	1.519	1.517	1.508
N° 10 (Bias2)	1.523	1.526	1.522	1.520	1.510
N° 11 (Bias2)	1.524	1.528	1.523	1.521	1.512
N° 12 (OFF)	1.519	1.521	1.519	1.518	1.506
N° 13 (OFF)	1.521	1.523	1.521	1.519	1.509
N° 14 (OFF)	1.521	1.524	1.521	1.520	1.511
N° 15 (OFF)	1.519	1.521	1.519	1.517	1.507
N° 16 (OFF)	1.519	1.522	1.520	1.518	1.509

Delta [VF]

	0,p/cm ²	4E10,p/cm ²	2E11,p/cm ²	4E11,p/cm ²	1.91E12,p/cm ²
N° 1 (Ref)	---	-2.770E-4	6.200E-4	3.797E-3	-6.800E-4
N° 2 (Bias1)	---	2.310E-4	-3.340E-4	-1.844E-3	-9.277E-3
N° 3 (Bias1)	---	4.390E-4	3.010E-4	-1.276E-3	-9.095E-3
N° 4 (Bias1)	---	4.260E-4	1.190E-4	-1.987E-3	-8.365E-3
N° 5 (Bias1)	---	7.350E-4	3.800E-4	-1.200E-3	-8.552E-3
N° 6 (Bias1)	---	1.055E-3	4.960E-4	-7.850E-4	-8.190E-3
N° 7 (Bias2)	---	3.301E-3	-5.260E-4	-2.356E-3	-1.213E-2
N° 8 (Bias2)	---	3.133E-3	-2.510E-4	-2.313E-3	-1.208E-2
N° 9 (Bias2)	---	4.015E-3	-5.020E-4	-2.609E-3	-1.181E-2
N° 10 (Bias2)	---	3.698E-3	-9.740E-4	-2.844E-3	-1.302E-2
N° 11 (Bias2)	---	3.930E-3	-5.370E-4	-2.261E-3	-1.187E-2
N° 12 (OFF)	---	2.375E-3	2.420E-4	-9.340E-4	-1.284E-2
N° 13 (OFF)	---	1.721E-3	-6.500E-5	-1.424E-3	-1.140E-2
N° 14 (OFF)	---	2.477E-3	-4.900E-5	-9.820E-4	-1.058E-2
N° 15 (OFF)	---	1.980E-3	-1.480E-4	-1.261E-3	-1.136E-2
N° 16 (OFF)	---	2.657E-3	2.600E-4	-9.370E-4	-1.091E-2
Average (Bias1)	---	5.772E-4	1.924E-4	-1.418E-3	-8.696E-3
σ (Bias1)	---	3.221E-4	3.247E-4	4.934E-4	4.699E-4
Average+3σ (Bias1)	---	1.544E-3	1.166E-3	6.168E-5	-7.286E-3
Average-3σ (Bias1)	---	-3.891E-4	-7.816E-4	-2.898E-3	-1.011E-2
Average (Bias2)	---	3.615E-3	-5.580E-4	-2.477E-3	-1.218E-2
σ (Bias2)	---	3.863E-4	2.607E-4	2.451E-4	4.874E-4
Average+3σ (Bias2)	---	4.774E-3	2.242E-4	-1.741E-3	-1.072E-2
Average-3σ (Bias2)	---	2.456E-3	-1.340E-3	-3.212E-3	-1.364E-2
Average (OFF)	---	2.242E-3	4.800E-5	-1.108E-3	-1.142E-2
σ (OFF)	---	3.825E-4	1.892E-4	2.229E-4	8.631E-4
Average+3σ (OFF)	---	3.389E-3	6.156E-4	-4.390E-4	-8.827E-3
Average-3σ (OFF)	---	1.095E-3	-5.196E-4	-1.776E-3	-1.401E-2

190 MeV proton / detailed results

4. BVr

Ta=25°C; Ir=10μA

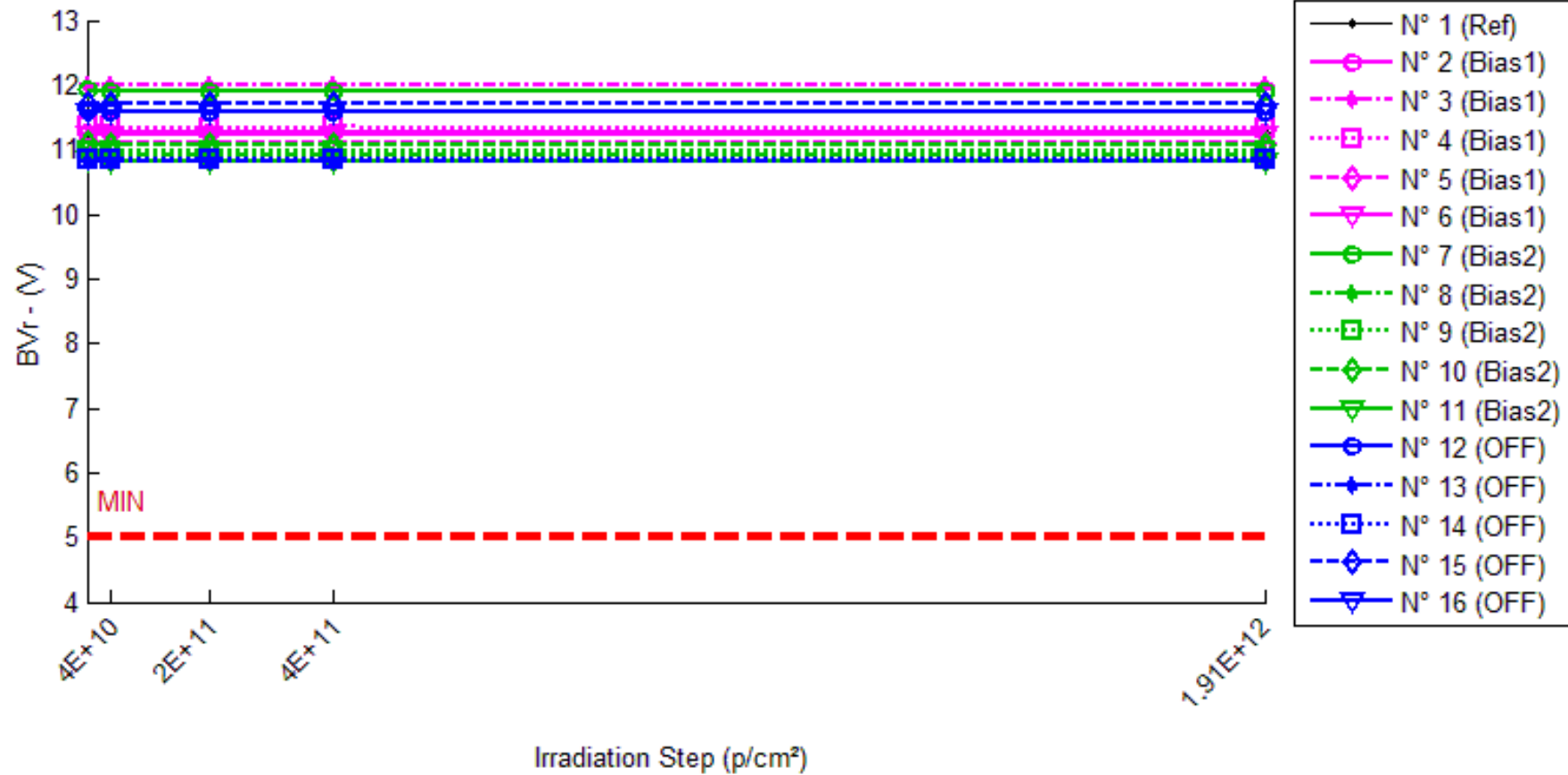

190 MeV proton / detailed results

BVr . (V)

Min = 5.0

	0,p/cm ²	4E10,p/cm ²	2E11,p/cm ²	4E11,p/cm ²	1.91E12,p/cm ²
N° 1 (Ref)	11.259	11.260	11.255	11.242	11.264
N° 2 (Bias1)	11.266	11.264	11.259	11.259	11.258
N° 3 (Bias1)	11.990	11.987	11.979	11.981	11.983
N° 4 (Bias1)	11.349	11.346	11.338	11.343	11.337
N° 5 (Bias1)	11.122	11.117	11.111	11.112	11.112
N° 6 (Bias1)	11.234	11.229	11.224	11.224	11.223
N° 7 (Bias2)	11.919	11.896	11.907	11.910	11.913
N° 8 (Bias2)	10.923	10.908	10.917	10.917	10.916
N° 9 (Bias2)	10.982	10.965	10.977	10.980	10.982
N° 10 (Bias2)	11.086	11.069	11.076	11.078	11.082
N° 11 (Bias2)	10.830	10.813	10.822	10.823	10.824
N° 12 (OFF)	11.597	11.585	11.587	11.586	11.595
N° 13 (OFF)	10.826	10.818	10.819	10.817	10.821
N° 14 (OFF)	10.848	10.837	10.839	10.836	10.839
N° 15 (OFF)	11.717	11.706	11.708	11.704	11.703
N° 16 (OFF)	11.582	11.570	11.573	11.571	11.566

Delta [BVr]

	0,p/cm ²	4E10,p/cm ²	2E11,p/cm ²	4E11,p/cm ²	1.91E12,p/cm ²
N° 1 (Ref)	---	7.100E-4	-3.990E-3	-1.750E-2	4.370E-3
N° 2 (Bias1)	---	-1.870E-3	-7.270E-3	-6.670E-3	-7.990E-3
N° 3 (Bias1)	---	-2.400E-3	-1.051E-2	-9.180E-3	-6.340E-3
N° 4 (Bias1)	---	-2.860E-3	-1.072E-2	-6.110E-3	-1.151E-2
N° 5 (Bias1)	---	-4.100E-3	-1.092E-2	-9.200E-3	-9.700E-3
N° 6 (Bias1)	---	-5.220E-3	-1.040E-2	-1.008E-2	-1.068E-2
N° 7 (Bias2)	---	-2.242E-2	-1.213E-2	-9.150E-3	-6.110E-3
N° 8 (Bias2)	---	-1.497E-2	-6.160E-3	-5.450E-3	-6.930E-3
N° 9 (Bias2)	---	-1.750E-2	-5.730E-3	-2.460E-3	-4.300E-4
N° 10 (Bias2)	---	-1.749E-2	-9.790E-3	-8.550E-3	-4.360E-3
N° 11 (Bias2)	---	-1.752E-2	-8.480E-3	-7.380E-3	-5.990E-3
N° 12 (OFF)	---	-1.168E-2	-9.060E-3	-1.089E-2	-1.040E-3
N° 13 (OFF)	---	-7.940E-3	-7.260E-3	-8.830E-3	-4.810E-3
N° 14 (OFF)	---	-1.078E-2	-8.940E-3	-1.161E-2	-8.970E-3
N° 15 (OFF)	---	-1.087E-2	-8.800E-3	-1.272E-2	-1.344E-2
N° 16 (OFF)	---	-1.277E-2	-9.800E-3	-1.154E-2	-1.608E-2
Average (Bias1)	---	-3.290E-3	-9.964E-3	-8.248E-3	-9.244E-3
σ (Bias1)	---	1.358E-3	1.519E-3	1.746E-3	2.086E-3
Average+3σ (Bias1)	---	7.834E-4	-5.407E-3	-3.010E-3	-2.985E-3
Average-3σ (Bias1)	---	-7.363E-3	-1.452E-2	-1.349E-2	-1.550E-2
Average (Bias2)	---	-1.798E-2	-8.458E-3	-6.598E-3	-4.764E-3
σ (Bias2)	---	2.714E-3	2.645E-3	2.710E-3	2.596E-3
Average+3σ (Bias2)	---	-9.839E-3	-5.234E-4	1.532E-3	3.023E-3
Average-3σ (Bias2)	---	-2.612E-2	-1.639E-2	-1.473E-2	-1.255E-2
Average (OFF)	---	-1.081E-2	-8.772E-3	-1.112E-2	-8.868E-3
σ (OFF)	---	1.792E-3	9.294E-4	1.438E-3	6.137E-3
Average+3σ (OFF)	---	-5.433E-3	-5.984E-3	-6.803E-3	9.544E-3
Average-3σ (OFF)	---	-1.618E-2	-1.156E-2	-1.543E-2	-2.728E-2

190 MeV proton / detailed results

5. ICCH

Ta=25°C; Vcc=18V; If=0



190 MeV proton / detailed results

ICCH . (µA)

Max = 10.0

	0.p/cm ²	4E10.p/cm ²	2E11.p/cm ²	4E11.p/cm ²	1.91E12.p/cm ²
N° 1 (Ref)	0.038	0.040	0.049	0.044	0.043
N° 2 (Bias1)	0.038	0.050	0.040	0.041	0.042
N° 3 (Bias1)	0.041	0.035	0.045	0.048	0.044
N° 4 (Bias1)	0.037	0.045	0.042	0.044	0.043
N° 5 (Bias1)	0.036	0.041	0.037	0.035	0.045
N° 6 (Bias1)	0.042	0.046	0.041	0.045	0.039
N° 7 (Bias2)	0.037	0.045	0.039	0.041	0.041
N° 8 (Bias2)	0.046	0.034	0.042	0.042	0.035
N° 9 (Bias2)	0.035	0.041	0.037	0.035	0.040
N° 10 (Bias2)	0.033	0.034	0.042	0.045	0.045
N° 11 (Bias2)	0.038	0.040	0.045	0.037	0.043
N° 12 (OFF)	0.041	0.040	0.035	0.034	0.046
N° 13 (OFF)	0.050	0.036	0.035	0.046	0.039
N° 14 (OFF)	0.045	0.050	0.048	0.043	0.046
N° 15 (OFF)	0.040	0.043	0.040	0.046	0.048
N° 16 (OFF)	0.037	0.039	0.040	0.039	0.038

Delta [ICCH]

	0.p/cm ²	4E10.p/cm ²	2E11.p/cm ²	4E11.p/cm ²	1.91E12.p/cm ²
N° 1 (Ref)	---	2.300E-3	1.098E-2	6.030E-3	5.340E-3
N° 2 (Bias1)	---	1.158E-2	1.990E-3	2.650E-3	3.430E-3
N° 3 (Bias1)	---	-5.650E-3	3.450E-3	7.020E-3	2.580E-3
N° 4 (Bias1)	---	7.900E-3	4.190E-3	6.920E-3	5.230E-3
N° 5 (Bias1)	---	4.620E-3	1.420E-3	-1.170E-3	8.890E-3
N° 6 (Bias1)	---	4.290E-3	-7.800E-4	3.370E-3	-2.420E-3
N° 7 (Bias2)	---	7.860E-3	2.000E-3	3.210E-3	3.700E-3
N° 8 (Bias2)	---	-1.262E-2	-3.720E-3	-3.900E-3	-1.086E-2
N° 9 (Bias2)	---	5.770E-3	1.810E-3	-8.600E-4	4.310E-3
N° 10 (Bias2)	---	7.100E-4	9.030E-3	1.235E-2	1.233E-2
N° 11 (Bias2)	---	2.280E-3	6.440E-3	-7.000E-4	5.130E-3
N° 12 (OFF)	---	-1.170E-3	-5.840E-3	-7.200E-3	5.130E-3
N° 13 (OFF)	---	-1.369E-2	-1.529E-2	-3.780E-3	-1.063E-2
N° 14 (OFF)	---	5.770E-3	3.410E-3	-2.050E-3	1.000E-3
N° 15 (OFF)	---	2.690E-3	2.900E-3	5.480E-3	8.330E-3
N° 16 (OFF)	---	2.180E-3	3.220E-3	2.080E-3	1.420E-3
Average (Bias1)	---	4.548E-3	2.054E-3	3.758E-3	3.542E-3
σ (Bias1)	---	6.418E-3	1.933E-3	3.402E-3	4.121E-3
Average+3σ (Bias1)	---	2.380E-2	7.854E-3	1.396E-2	1.591E-2
Average-3σ (Bias1)	---	-1.471E-2	-3.746E-3	-6.449E-3	-8.821E-3
Average (Bias2)	---	8.000E-4	3.112E-3	2.020E-3	2.922E-3
σ (Bias2)	---	8.013E-3	4.891E-3	6.302E-3	8.454E-3
Average+3σ (Bias2)	---	2.484E-2	1.779E-2	2.093E-2	2.828E-2
Average-3σ (Bias2)	---	-2.324E-2	-1.156E-2	-1.689E-2	-2.244E-2
Average (OFF)	---	-8.440E-4	-2.842E-3	-1.094E-3	1.050E-3
σ (OFF)	---	7.591E-3	7.899E-3	4.967E-3	7.180E-3
Average+3σ (OFF)	---	2.193E-2	2.086E-2	1.381E-2	2.259E-2
Average-3σ (OFF)	---	-2.362E-2	-2.654E-2	-1.600E-2	-2.049E-2

190 MeV proton / detailed results

6. ICCL

Ta=25°C; Vcc=18V; If=20mA

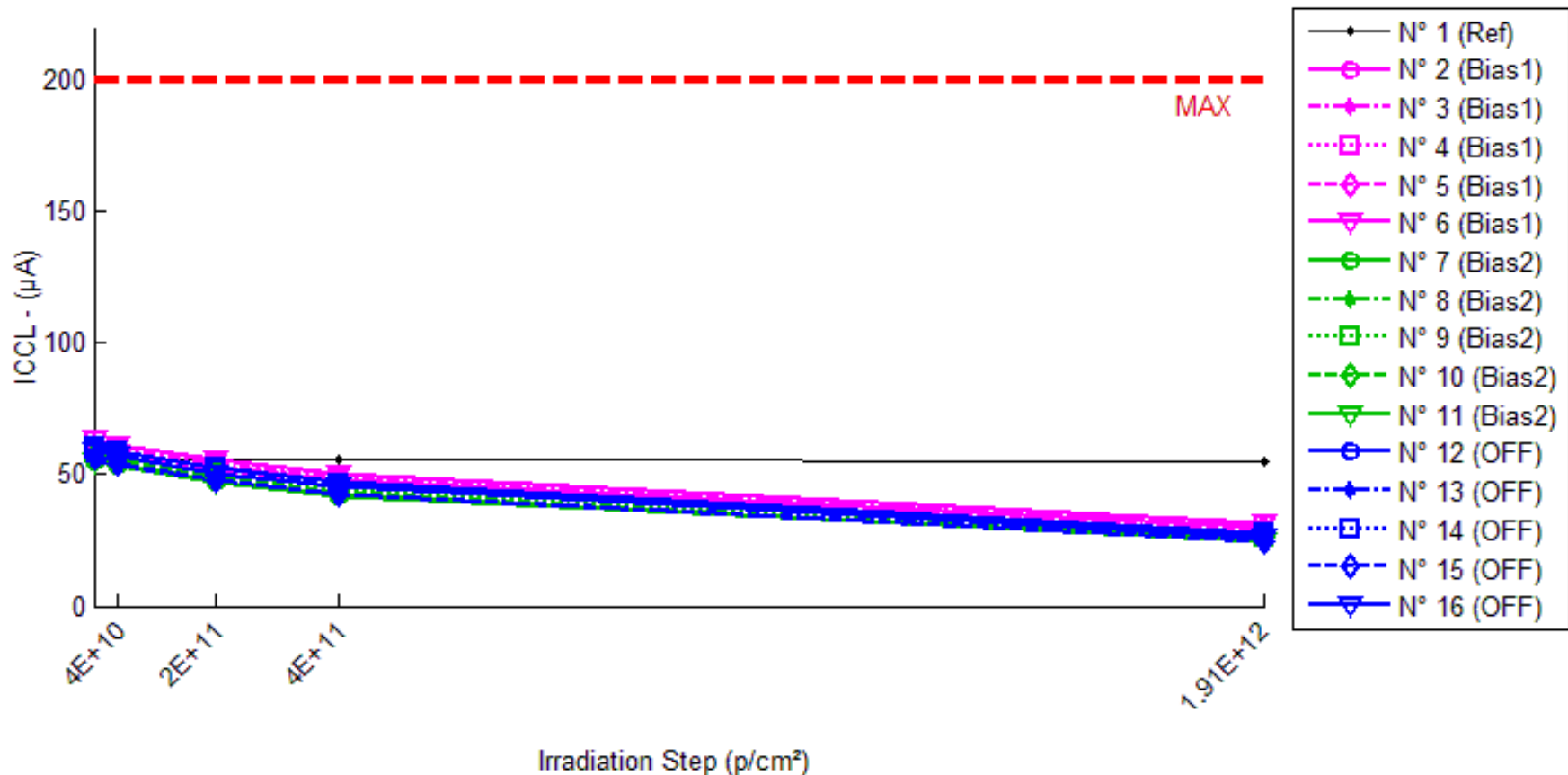

190 MeV proton / detailed results

ICCL . (µA)

Max = 200.0

	0,p/cm ²	4E10,p/cm ²	2E11,p/cm ²	4E11,p/cm ²	1.91E12,p/cm ²
N° 1 (Ref)	55.455	55.393	55.567	56.073	55.233
N° 2 (Bias1)	60.413	58.543	52.947	47.708	29.881
N° 3 (Bias1)	61.699	59.822	54.199	48.830	30.727
N° 4 (Bias1)	60.724	58.975	53.563	48.245	30.665
N° 5 (Bias1)	58.879	57.142	51.420	46.224	28.647
N° 6 (Bias1)	63.249	61.531	55.864	50.533	31.788
N° 7 (Bias2)	54.693	53.355	46.970	41.924	24.975
N° 8 (Bias2)	56.392	54.922	48.025	42.511	24.705
N° 9 (Bias2)	58.304	57.001	50.046	44.519	26.148
N° 10 (Bias2)	56.953	55.677	48.570	43.073	24.809
N° 11 (Bias2)	55.152	53.964	47.376	42.252	24.849
N° 12 (OFF)	60.385	58.760	52.314	46.963	27.433
N° 13 (OFF)	55.201	53.629	47.629	42.590	25.039
N° 14 (OFF)	60.680	59.102	52.412	46.804	27.645
N° 15 (OFF)	56.348	54.580	47.755	42.448	24.927
N° 16 (OFF)	58.810	57.306	50.695	45.296	26.424

Delta [ICCL]

	0,p/cm ²	4E10,p/cm ²	2E11,p/cm ²	4E11,p/cm ²	1.91E12,p/cm ²
N° 1 (Ref)	---	-6.229E-2	1.121E-1	6.179E-1	-2.223E-1
N° 2 (Bias1)	---	-1.870E+0	-7.466E+0	-1.270E+1	-3.053E+1
N° 3 (Bias1)	---	-1.878E+0	-7.500E+0	-1.287E+1	-3.097E+1
N° 4 (Bias1)	---	-1.749E+0	-7.161E+0	-1.248E+1	-3.006E+1
N° 5 (Bias1)	---	-1.737E+0	-7.459E+0	-1.266E+1	-3.023E+1
N° 6 (Bias1)	---	-1.719E+0	-7.386E+0	-1.272E+1	-3.146E+1
N° 7 (Bias2)	---	-1.338E+0	-7.723E+0	-1.277E+1	-2.972E+1
N° 8 (Bias2)	---	-1.470E+0	-8.367E+0	-1.388E+1	-3.169E+1
N° 9 (Bias2)	---	-1.303E+0	-8.257E+0	-1.378E+1	-3.216E+1
N° 10 (Bias2)	---	-1.276E+0	-8.383E+0	-1.388E+1	-3.214E+1
N° 11 (Bias2)	---	-1.188E+0	-7.776E+0	-1.290E+1	-3.030E+1
N° 12 (OFF)	---	-1.625E+0	-8.071E+0	-1.342E+1	-3.295E+1
N° 13 (OFF)	---	-1.572E+0	-7.572E+0	-1.261E+1	-3.016E+1
N° 14 (OFF)	---	-1.578E+0	-8.268E+0	-1.388E+1	-3.304E+1
N° 15 (OFF)	---	-1.768E+0	-8.592E+0	-1.390E+1	-3.142E+1
N° 16 (OFF)	---	-1.504E+0	-8.115E+0	-1.351E+1	-3.239E+1
Average (Bias1)	---	-1.791E+0	-7.394E+0	-1.269E+1	-3.065E+1
σ (Bias1)	---	7.707E-2	1.369E-1	1.401E-1	5.700E-1
Average+3σ (Bias1)	---	-1.559E+0	-6.984E+0	-1.226E+1	-2.894E+1
Average-3σ (Bias1)	---	-2.022E+0	-7.805E+0	-1.311E+1	-3.236E+1
Average (Bias2)	---	-1.315E+0	-8.101E+0	-1.344E+1	-3.120E+1
σ (Bias2)	---	1.028E-1	3.250E-1	5.587E-1	1.123E+0
Average+3σ (Bias2)	---	-1.007E+0	-7.126E+0	-1.177E+1	-2.783E+1
Average-3σ (Bias2)	---	-1.623E+0	-9.076E+0	-1.512E+1	-3.457E+1
Average (OFF)	---	-1.609E+0	-8.124E+0	-1.346E+1	-3.199E+1
σ (OFF)	---	9.865E-2	3.700E-1	5.224E-1	1.208E+0
Average+3σ (OFF)	---	-1.313E+0	-7.014E+0	-1.190E+1	-2.837E+1
Average-3σ (OFF)	---	-1.905E+0	-9.234E+0	-1.503E+1	-3.562E+1

190 MeV proton / detailed results

7. TPLH

Ta=25°C; RL=8.2 kOhms; Cl=50pF; If=16mA; Vcc=5V

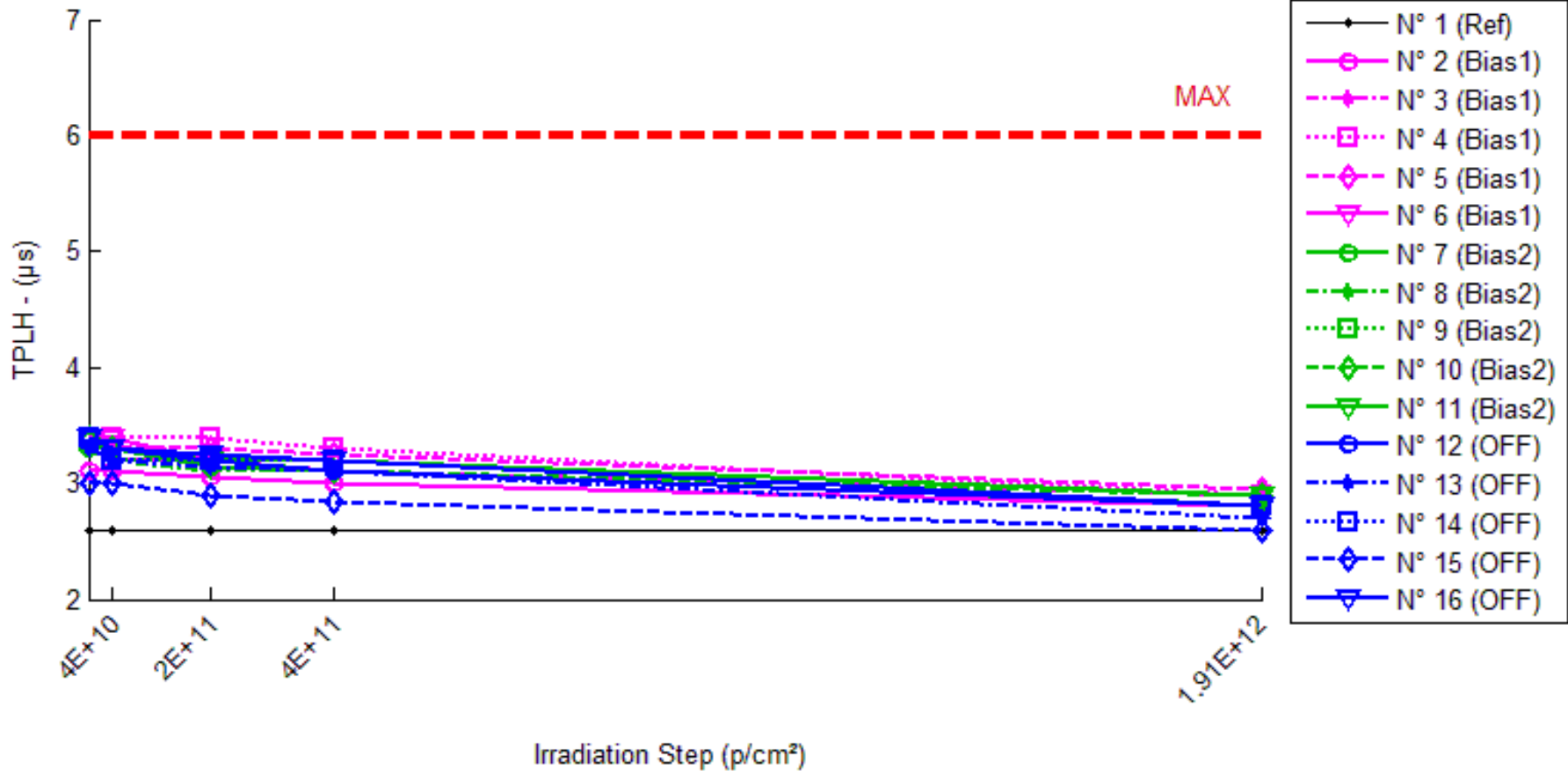

190 MeV proton / detailed results

TPH . (µs) Max = 6.0

	0.p/cm ²	4E10.p/cm ²	2E11.p/cm ²	4E11.p/cm ²	1.91E12.p/cm ²
N° 1 (Ref)	2.60	2.60	2.60	2.60	2.60
N° 2 (Bias1)	3.10	3.10	3.05	3.00	2.80
N° 3 (Bias1)	3.30	3.20	3.20	3.10	2.90
N° 4 (Bias1)	3.40	3.40	3.40	3.30	2.90
N° 5 (Bias1)	3.40	3.30	3.30	3.25	2.95
N° 6 (Bias1)	3.40	3.40	3.20	3.20	2.90
N° 7 (Bias2)	3.30	3.30	3.15	3.10	2.80
N° 8 (Bias2)	3.30	3.20	3.10	3.10	2.80
N° 9 (Bias2)	3.35	3.20	3.20	3.20	2.80
N° 10 (Bias2)	3.40	3.30	3.20	3.10	2.90
N° 11 (Bias2)	3.40	3.30	3.20	3.20	2.90
N° 12 (OFF)	3.40	3.30	3.20	3.10	2.80
N° 13 (OFF)	3.30	3.20	3.15	3.10	2.70
N° 14 (OFF)	3.40	3.20	3.20	3.20	2.80
N° 15 (OFF)	3.00	3.00	2.90	2.85	2.60
N° 16 (OFF)	3.40	3.30	3.25	3.20	2.80

Delta [TPH]

	0.p/cm ²	4E10.p/cm ²	2E11.p/cm ²	4E11.p/cm ²	1.91E12.p/cm ²
N° 1 (Ref)	---	0.000E+0	0.000E+0	0.000E+0	0.000E+0
N° 2 (Bias1)	---	0.000E+0	-5.000E-2	-1.000E-1	-3.000E-1
N° 3 (Bias1)	---	-1.000E-1	-1.000E-1	-2.000E-1	-4.000E-1
N° 4 (Bias1)	---	0.000E+0	0.000E+0	-1.000E-1	-5.000E-1
N° 5 (Bias1)	---	-1.000E-1	-1.000E-1	-1.500E-1	-4.500E-1
N° 6 (Bias1)	---	0.000E+0	-2.000E-1	-2.000E-1	-5.000E-1
N° 7 (Bias2)	---	0.000E+0	-1.500E-1	-2.000E-1	-5.000E-1
N° 8 (Bias2)	---	-1.000E-1	-2.000E-1	-2.000E-1	-5.000E-1
N° 9 (Bias2)	---	-1.500E-1	-1.500E-1	-1.500E-1	-5.500E-1
N° 10 (Bias2)	---	-1.000E-1	-2.000E-1	-3.000E-1	-5.000E-1
N° 11 (Bias2)	---	-1.000E-1	-2.000E-1	-2.000E-1	-5.000E-1
N° 12 (OFF)	---	-1.000E-1	-2.000E-1	-3.000E-1	-6.000E-1
N° 13 (OFF)	---	-1.000E-1	-1.500E-1	-2.000E-1	-6.000E-1
N° 14 (OFF)	---	-2.000E-1	-2.000E-1	-2.000E-1	-6.000E-1
N° 15 (OFF)	---	0.000E+0	-1.000E-1	-1.500E-1	-4.000E-1
N° 16 (OFF)	---	-1.000E-1	-1.500E-1	-2.000E-1	-6.000E-1
Average (Bias1)	---	-4.000E-2	-9.000E-2	-1.500E-1	-4.300E-1
σ (Bias1)	---	5.477E-2	7.416E-2	5.000E-2	8.367E-2
Average+3σ (Bias1)	---	1.243E-1	1.325E-1	-4.441E-16	-1.790E-1
Average-3σ (Bias1)	---	-2.043E-1	-3.125E-1	-3.000E-1	-6.810E-1
Average (Bias2)	---	-9.000E-2	-1.800E-1	-2.100E-1	-5.100E-1
σ (Bias2)	---	5.477E-2	2.739E-2	5.477E-2	2.236E-2
Average+3σ (Bias2)	---	7.432E-2	-9.784E-2	-4.568E-2	-4.429E-1
Average-3σ (Bias2)	---	-2.543E-1	-2.622E-1	-3.743E-1	-5.771E-1
Average (OFF)	---	-1.000E-1	-1.600E-1	-2.100E-1	-5.600E-1
σ (OFF)	---	7.071E-2	4.183E-2	5.477E-2	8.944E-2
Average+3σ (OFF)	---	1.121E-1	-3.450E-2	-4.568E-2	-2.917E-1
Average-3σ (OFF)	---	-3.121E-1	-2.855E-1	-3.743E-1	-8.283E-1

190 MeV proton / detailed results

8. TPHL

Ta=25°C; RL=8.2 kOhms; Cl=50pF; If=16mA; Vcc=5V

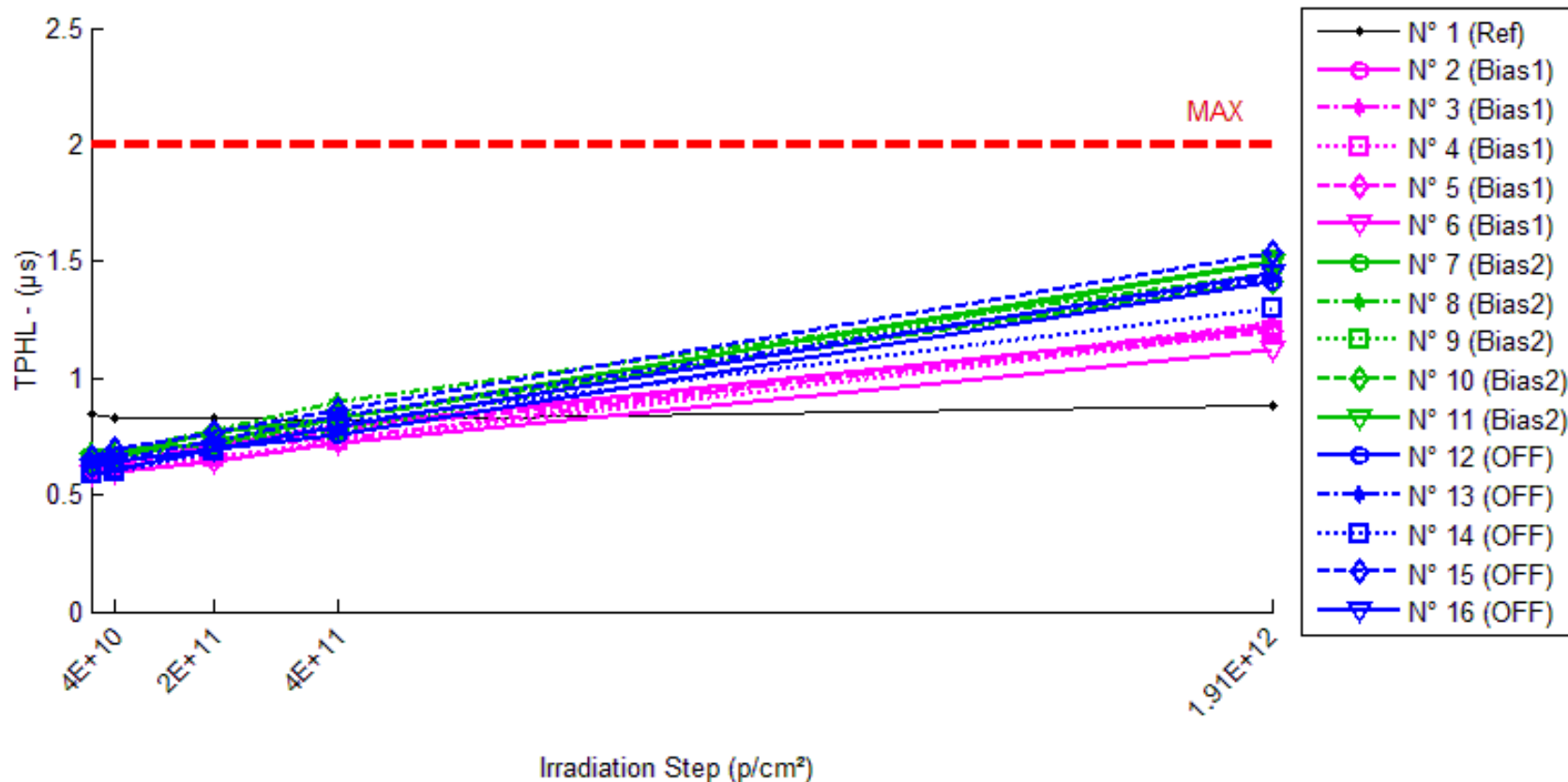

190 MeV proton / detailed results

TPHL . (µs)

Max = 2.0

	0.p/cm ²	4E10.p/cm ²	2E11.p/cm ²	4E11.p/cm ²	1.91E12.p/cm ²
N° 1 (Ref)	0.85	0.83	0.83	0.82	0.88
N° 2 (Bias1)	0.61	0.63	0.71	0.79	1.22
N° 3 (Bias1)	0.60	0.63	0.71	0.74	1.24
N° 4 (Bias1)	0.59	0.61	0.66	0.73	1.20
N° 5 (Bias1)	0.63	0.62	0.71	0.78	1.20
N° 6 (Bias1)	0.59	0.60	0.64	0.72	1.12
N° 7 (Bias2)	0.66	0.67	0.77	0.83	1.50
N° 8 (Bias2)	0.69	0.69	0.78	0.90	1.45
N° 9 (Bias2)	0.64	0.64	0.73	0.78	1.50
N° 10 (Bias2)	0.63	0.70	0.71	0.83	1.41
N° 11 (Bias2)	0.64	0.66	0.73	0.83	1.49
N° 12 (OFF)	0.59	0.61	0.70	0.76	1.41
N° 13 (OFF)	0.64	0.65	0.73	0.84	1.43
N° 14 (OFF)	0.59	0.60	0.69	0.81	1.30
N° 15 (OFF)	0.66	0.70	0.77	0.86	1.54
N° 16 (OFF)	0.62	0.64	0.70	0.79	1.45

Delta [TPHL]

	0.p/cm ²	4E10.p/cm ²	2E11.p/cm ²	4E11.p/cm ²	1.91E12.p/cm ²
N° 1 (Ref)	---	-2.000E-2	-2.000E-2	-3.000E-2	3.000E-2
N° 2 (Bias1)	---	2.000E-2	1.000E-1	1.800E-1	6.100E-1
N° 3 (Bias1)	---	3.000E-2	1.100E-1	1.400E-1	6.400E-1
N° 4 (Bias1)	---	2.000E-2	7.000E-2	1.400E-1	6.100E-1
N° 5 (Bias1)	---	-1.000E-2	8.000E-2	1.500E-1	5.700E-1
N° 6 (Bias1)	---	1.000E-2	5.000E-2	1.300E-1	5.300E-1
N° 7 (Bias2)	---	1.000E-2	1.100E-1	1.700E-1	8.400E-1
N° 8 (Bias2)	---	0.000E+0	9.000E-2	2.100E-1	7.600E-1
N° 9 (Bias2)	---	0.000E+0	9.000E-2	1.400E-1	8.600E-1
N° 10 (Bias2)	---	7.000E-2	8.000E-2	2.000E-1	7.800E-1
N° 11 (Bias2)	---	2.000E-2	9.000E-2	1.900E-1	8.500E-1
N° 12 (OFF)	---	2.000E-2	1.100E-1	1.700E-1	8.200E-1
N° 13 (OFF)	---	1.000E-2	9.000E-2	2.000E-1	7.900E-1
N° 14 (OFF)	---	1.000E-2	1.000E-1	2.200E-1	7.100E-1
N° 15 (OFF)	---	4.000E-2	1.100E-1	2.000E-1	8.800E-1
N° 16 (OFF)	---	2.000E-2	8.000E-2	1.700E-1	8.300E-1
Average (Bias1)	---	1.400E-2	8.200E-2	1.480E-1	5.920E-1
σ (Bias1)	---	1.517E-2	2.387E-2	1.924E-2	4.266E-2
Average+3σ (Bias1)	---	5.950E-2	1.536E-1	2.057E-1	7.200E-1
Average-3σ (Bias1)	---	-3.150E-2	1.038E-2	9.029E-2	4.640E-1
Average (Bias2)	---	2.000E-2	9.200E-2	1.820E-1	8.180E-1
σ (Bias2)	---	2.915E-2	1.095E-2	2.775E-2	4.494E-2
Average+3σ (Bias2)	---	1.075E-1	1.249E-1	2.652E-1	9.528E-1
Average-3σ (Bias2)	---	-6.746E-2	5.914E-2	9.875E-2	6.832E-1
Average (OFF)	---	2.000E-2	9.800E-2	1.920E-1	8.060E-1
σ (OFF)	---	1.225E-2	1.304E-2	2.168E-2	6.269E-2
Average+3σ (OFF)	---	5.674E-2	1.371E-1	2.570E-1	9.941E-1
Average-3σ (OFF)	---	-1.674E-2	5.888E-2	1.270E-1	6.179E-1

190 MeV proton / detailed results

9. CTR1

Ta=25°C; Vo=0.4V; If=2mA; Vcc=5V

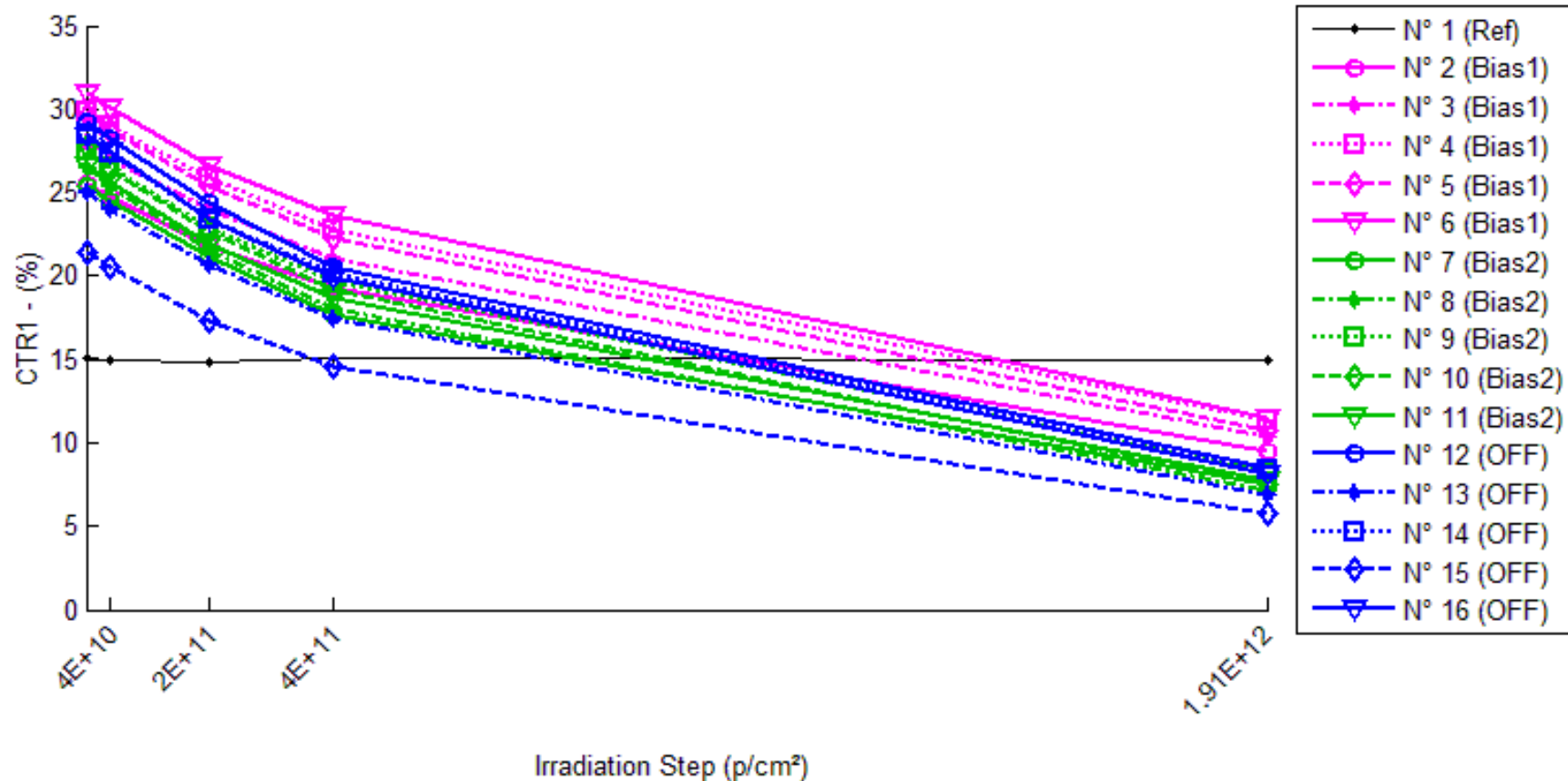

190 MeV proton / detailed results

CTR1 . (%)

	0,p/cm ²	4E10,p/cm ²	2E11,p/cm ²	4E11,p/cm ²	1.91E12,p/cm ²
N° 1 (Ref)	15.02	14.98	14.88	15.09	14.96
N° 2 (Bias1)	25.51	24.74	21.83	19.27	9.48
N° 3 (Bias1)	27.93	27.00	24.02	20.98	10.37
N° 4 (Bias1)	29.86	29.02	25.90	22.83	11.41
N° 5 (Bias1)	29.65	28.73	25.40	22.33	10.79
N° 6 (Bias1)	30.91	30.09	26.65	23.60	11.50
N° 7 (Bias2)	25.41	24.50	21.21	17.68	7.47
N° 8 (Bias2)	26.51	25.37	21.49	18.11	7.19
N° 9 (Bias2)	27.54	26.56	22.95	19.68	8.21
N° 10 (Bias2)	27.69	26.41	22.60	19.19	7.48
N° 11 (Bias2)	26.62	25.58	21.91	18.66	7.81
N° 12 (OFF)	29.18	28.27	24.40	20.58	8.54
N° 13 (OFF)	25.03	24.05	20.68	17.47	6.84
N° 14 (OFF)	28.51	27.42	23.44	20.15	8.37
N° 15 (OFF)	21.40	20.54	17.36	14.62	5.73
N° 16 (OFF)	28.41	27.46	23.39	19.98	8.07

1/Delta [CTR1]

	0,p/cm ²	4E10,p/cm ²	2E11,p/cm ²	4E11,p/cm ²	1.91E12,p/cm ²
N° 1 (Ref)	---	2.044E-4	6.463E-4	-3.140E-4	2.575E-4
N° 2 (Bias1)	---	1.232E-3	6.613E-3	1.270E-2	6.624E-2
N° 3 (Bias1)	---	1.236E-3	5.828E-3	1.186E-2	6.068E-2
N° 4 (Bias1)	---	9.688E-4	5.130E-3	1.031E-2	5.414E-2
N° 5 (Bias1)	---	1.079E-3	5.647E-3	1.105E-2	5.893E-2
N° 6 (Bias1)	---	8.829E-4	5.162E-3	1.002E-2	5.457E-2
N° 7 (Bias2)	---	1.456E-3	7.781E-3	1.719E-2	9.452E-2
N° 8 (Bias2)	---	1.699E-3	8.807E-3	1.749E-2	1.014E-1
N° 9 (Bias2)	---	1.330E-3	7.262E-3	1.449E-2	8.543E-2
N° 10 (Bias2)	---	1.751E-3	8.135E-3	1.598E-2	9.752E-2
N° 11 (Bias2)	---	1.528E-3	8.078E-3	1.603E-2	9.051E-2
N° 12 (OFF)	---	1.098E-3	6.720E-3	1.433E-2	8.276E-2
N° 13 (OFF)	---	1.614E-3	8.403E-3	1.729E-2	1.062E-1
N° 14 (OFF)	---	1.400E-3	7.587E-3	1.456E-2	8.436E-2
N° 15 (OFF)	---	1.950E-3	1.086E-2	2.167E-2	1.278E-1
N° 16 (OFF)	---	1.224E-3	7.567E-3	1.485E-2	8.865E-2
Average (Bias1)	---	1.080E-3	5.676E-3	1.119E-2	5.891E-2
σ (Bias1)	---	1.569E-4	6.052E-4	1.106E-3	4.962E-3
Average+3 σ (Bias1)	---	1.550E-3	7.492E-3	1.451E-2	7.380E-2
Average-3 σ (Bias1)	---	6.088E-4	3.861E-3	7.869E-3	4.403E-2
Average (Bias2)	---	1.553E-3	8.013E-3	1.624E-2	9.388E-2
σ (Bias2)	---	1.735E-4	5.628E-4	1.186E-3	6.180E-3
Average+3 σ (Bias2)	---	2.074E-3	9.701E-3	1.980E-2	1.124E-1
Average-3 σ (Bias2)	---	1.033E-3	6.324E-3	1.268E-2	7.533E-2
Average (OFF)	---	1.457E-3	8.229E-3	1.654E-2	9.796E-2
σ (OFF)	---	3.369E-4	1.589E-3	3.103E-3	1.911E-2
Average+3 σ (OFF)	---	2.468E-3	1.300E-2	2.585E-2	1.553E-1
Average-3 σ (OFF)	---	4.467E-4	3.461E-3	7.227E-3	4.064E-2

190 MeV proton / detailed results

10.CTR2

Ta=25°C; Vo=0.4V; If=4mA; Vcc=5V

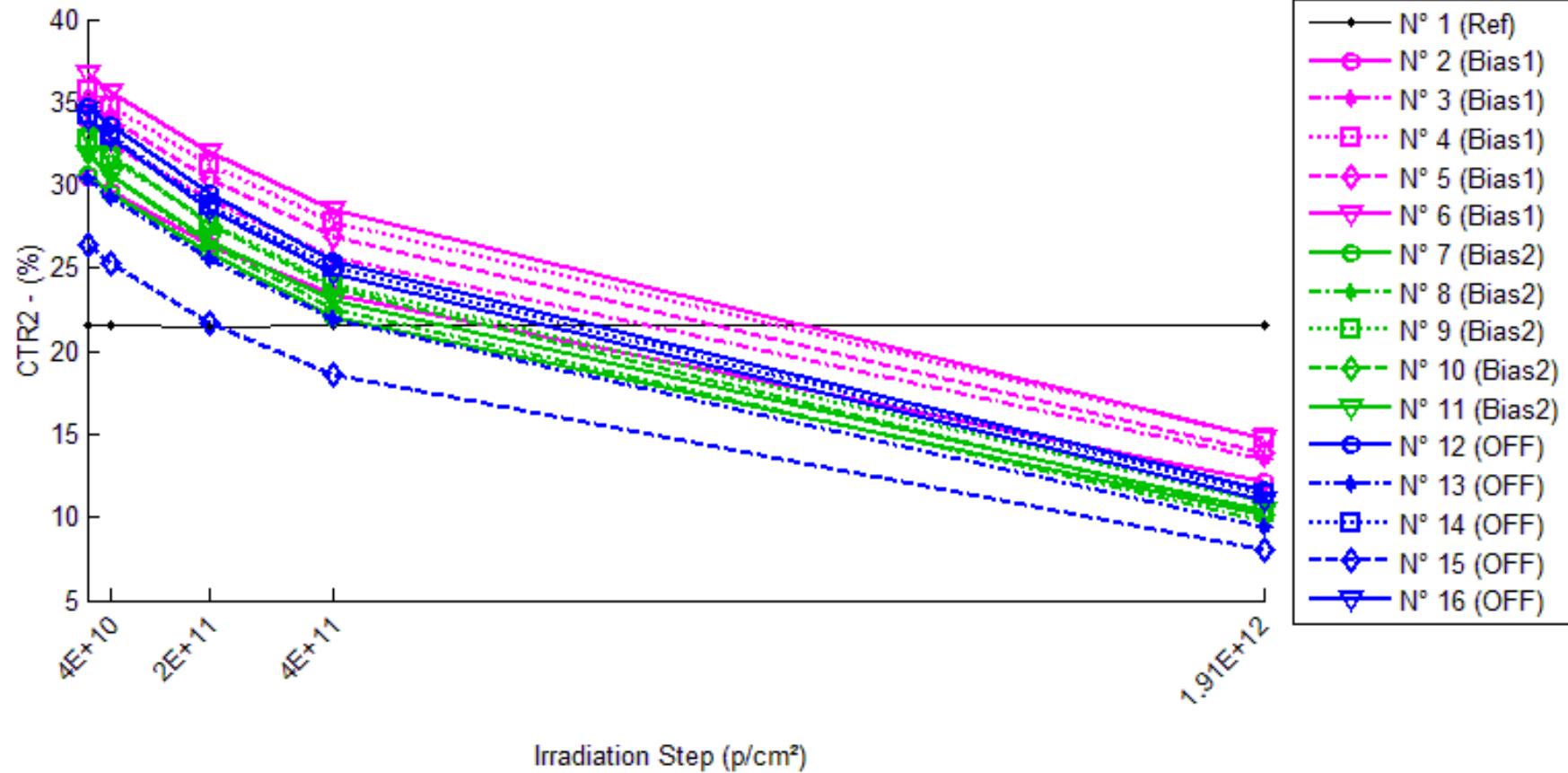

190 MeV proton / detailed results

CTR2 . (%)

	0.p/cm ²	4E10.p/cm ²	2E11.p/cm ²	4E11.p/cm ²	1.91E12.p/cm ²
N° 1 (Ref)	21.56	21.54	21.49	21.63	21.52
N° 2 (Bias1)	30.55	29.62	26.40	23.44	12.16
N° 3 (Bias1)	33.57	32.47	29.12	25.68	13.44
N° 4 (Bias1)	35.72	34.71	31.27	27.82	14.70
N° 5 (Bias1)	35.10	34.04	30.39	26.95	13.84
N° 6 (Bias1)	36.65	35.65	31.94	28.50	14.80
N° 7 (Bias2)	30.62	29.53	25.89	22.01	10.09
N° 8 (Bias2)	32.00	30.68	26.43	22.61	9.76
N° 9 (Bias2)	32.78	31.62	27.73	24.09	10.94
N° 10 (Bias2)	33.27	31.85	27.68	23.78	10.16
N° 11 (Bias2)	31.86	30.66	26.65	23.00	10.43
N° 12 (OFF)	34.78	33.66	29.54	25.43	11.58
N° 13 (OFF)	30.37	29.26	25.49	21.91	9.45
N° 14 (OFF)	34.28	33.03	28.77	25.04	11.37
N° 15 (OFF)	26.37	25.32	21.74	18.58	7.99
N° 16 (OFF)	33.97	32.86	28.49	24.69	10.97

1/Delta [CTR2]

	0.p/cm ²	4E10.p/cm ²	2E11.p/cm ²	4E11.p/cm ²	1.91E12.p/cm ²
N° 1 (Ref)	---	5.173E-5	1.679E-4	-1.369E-4	8.987E-5
N° 2 (Bias1)	---	1.024E-3	5.145E-3	9.921E-3	4.948E-2
N° 3 (Bias1)	---	1.009E-3	4.552E-3	9.153E-3	4.461E-2
N° 4 (Bias1)	---	8.123E-4	3.985E-3	7.949E-3	4.004E-2
N° 5 (Bias1)	---	8.909E-4	4.416E-3	8.619E-3	4.379E-2
N° 6 (Bias1)	---	7.654E-4	4.020E-3	7.800E-3	4.026E-2
N° 7 (Bias2)	---	1.208E-3	5.976E-3	1.277E-2	6.646E-2
N° 8 (Bias2)	---	1.342E-3	6.588E-3	1.298E-2	7.123E-2
N° 9 (Bias2)	---	1.124E-3	5.554E-3	1.102E-2	6.089E-2
N° 10 (Bias2)	---	1.333E-3	6.070E-3	1.200E-2	6.835E-2
N° 11 (Bias2)	---	1.228E-3	6.136E-3	1.209E-2	6.453E-2
N° 12 (OFF)	---	9.634E-4	5.102E-3	1.057E-2	5.763E-2
N° 13 (OFF)	---	1.250E-3	6.297E-3	1.271E-2	7.292E-2
N° 14 (OFF)	---	1.104E-3	5.579E-3	1.077E-2	5.876E-2
N° 15 (OFF)	---	1.576E-3	8.078E-3	1.589E-2	8.725E-2
N° 16 (OFF)	---	9.899E-4	5.659E-3	1.106E-2	6.168E-2
Average (Bias1)	---	9.003E-4	4.424E-3	8.688E-3	4.364E-2
σ (Bias1)	---	1.153E-4	4.724E-4	8.771E-4	3.857E-3
Average+3σ (Bias1)	---	1.246E-3	5.841E-3	1.132E-2	5.521E-2
Average-3σ (Bias1)	---	5.544E-4	3.006E-3	6.057E-3	3.207E-2
Average (Bias2)	---	1.247E-3	6.065E-3	1.217E-2	6.629E-2
σ (Bias2)	---	9.167E-5	3.698E-4	7.716E-4	3.904E-3
Average+3σ (Bias2)	---	1.522E-3	7.174E-3	1.449E-2	7.800E-2
Average-3σ (Bias2)	---	9.721E-4	4.955E-3	9.856E-3	5.458E-2
Average (OFF)	---	1.177E-3	6.143E-3	1.220E-2	6.765E-2
σ (OFF)	---	2.501E-4	1.162E-3	2.230E-3	1.252E-2
Average+3σ (OFF)	---	1.927E-3	9.630E-3	1.889E-2	1.052E-1
Average-3σ (OFF)	---	4.265E-4	2.656E-3	5.508E-3	3.009E-2

190 MeV proton / detailed results

11.CTR3

Ta=25°C; Vo=0.4V; If=16mA; Vcc=4.5V

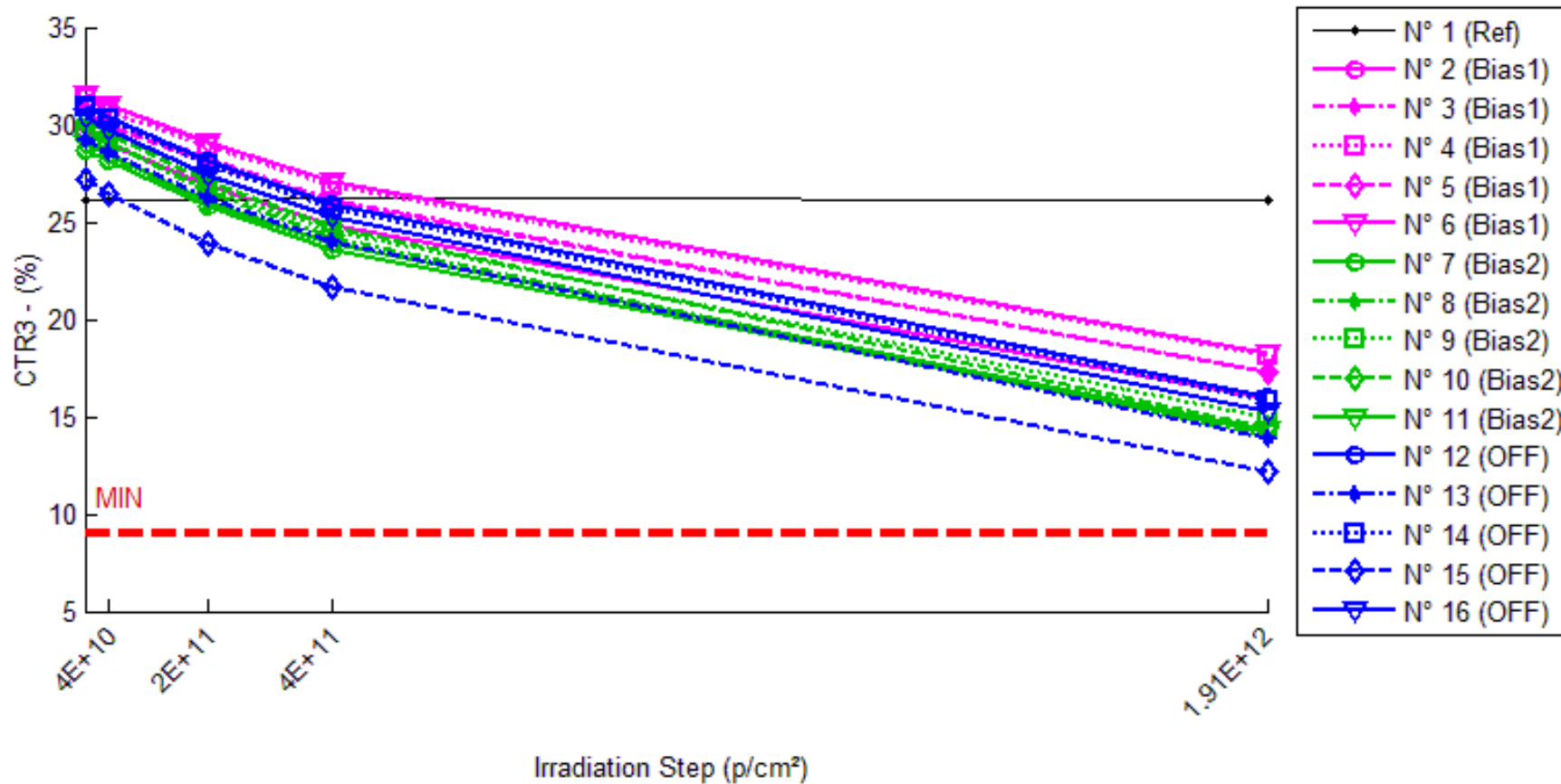

190 MeV proton / detailed results

CTR3 . (%)

Min = 9.0

	0.p/cm ²	4E10.p/cm ²	2E11.p/cm ²	4E11.p/cm ²	1.91E12.p/cm ²
N° 1 (Ref)	26.12	26.13	26.17	26.27	26.10
N° 2 (Bias1)	29.60	28.96	26.90	24.83	15.93
N° 3 (Bias1)	30.91	30.24	28.25	26.12	17.30
N° 4 (Bias1)	31.31	30.73	28.86	26.88	18.19
N° 5 (Bias1)	30.60	29.98	28.03	26.05	17.25
N° 6 (Bias1)	31.57	30.99	29.06	27.10	18.22
N° 7 (Bias2)	28.69	28.11	25.82	23.53	14.23
N° 8 (Bias2)	29.79	29.13	26.55	24.17	13.97
N° 9 (Bias2)	29.59	29.05	26.75	24.57	14.98
N° 10 (Bias2)	30.19	29.55	27.06	24.72	14.45
N° 11 (Bias2)	28.97	28.41	26.03	23.86	14.35
N° 12 (OFF)	30.95	30.34	28.11	25.86	15.96
N° 13 (OFF)	29.19	28.55	26.23	23.99	13.90
N° 14 (OFF)	30.88	30.26	27.91	25.74	15.81
N° 15 (OFF)	27.14	26.41	23.91	21.66	12.15
N° 16 (OFF)	30.34	29.76	27.41	25.23	15.30

1/Delta [CTR3]

	0.p/cm ²	4E10.p/cm ²	2E11.p/cm ²	4E11.p/cm ²	1.91E12.p/cm ²
N° 1 (Ref)	---	-1.226E-5	-6.214E-5	-2.070E-4	3.436E-5
N° 2 (Bias1)	---	7.454E-4	3.394E-3	6.493E-3	2.898E-2
N° 3 (Bias1)	---	7.122E-4	3.046E-3	5.934E-3	2.546E-2
N° 4 (Bias1)	---	6.056E-4	2.708E-3	5.261E-3	2.303E-2
N° 5 (Bias1)	---	6.706E-4	2.989E-3	5.710E-3	2.529E-2
N° 6 (Bias1)	---	5.921E-4	2.734E-3	5.221E-3	2.320E-2
N° 7 (Bias2)	---	7.266E-4	3.873E-3	7.654E-3	3.542E-2
N° 8 (Bias2)	---	7.567E-4	4.093E-3	7.805E-3	3.804E-2
N° 9 (Bias2)	---	6.303E-4	3.588E-3	6.900E-3	3.297E-2
N° 10 (Bias2)	---	7.121E-4	3.825E-3	7.323E-3	3.605E-2
N° 11 (Bias2)	---	6.847E-4	3.895E-3	7.394E-3	3.515E-2
N° 12 (OFF)	---	6.483E-4	3.258E-3	6.353E-3	3.035E-2
N° 13 (OFF)	---	7.669E-4	3.867E-3	7.429E-3	3.771E-2
N° 14 (OFF)	---	6.625E-4	3.447E-3	6.471E-3	3.087E-2
N° 15 (OFF)	---	1.010E-3	4.973E-3	9.325E-3	4.547E-2
N° 16 (OFF)	---	6.392E-4	3.523E-3	6.679E-3	3.239E-2
Average (Bias1)	---	6.651E-4	2.974E-3	5.724E-3	2.519E-2
σ (Bias1)	---	6.627E-5	2.785E-4	5.251E-4	2.404E-3
Average+3σ (Bias1)	---	8.640E-4	3.810E-3	7.299E-3	3.241E-2
Average-3σ (Bias1)	---	4.663E-4	2.139E-3	4.149E-3	1.798E-2
Average (Bias2)	---	7.021E-4	3.855E-3	7.415E-3	3.553E-2
σ (Bias2)	---	4.779E-5	1.806E-4	3.478E-4	1.820E-3
Average+3σ (Bias2)	---	8.455E-4	4.397E-3	8.459E-3	4.098E-2
Average-3σ (Bias2)	---	5.587E-4	3.313E-3	6.372E-3	3.007E-2
Average (OFF)	---	7.453E-4	3.814E-3	7.251E-3	3.536E-2
σ (OFF)	---	1.564E-4	6.845E-4	1.233E-3	6.362E-3
Average+3σ (OFF)	---	1.214E-3	5.867E-3	1.095E-2	5.444E-2
Average-3σ (OFF)	---	2.761E-4	1.760E-3	3.554E-3	1.627E-2

190 MeV proton / detailed results

12.CTR4

Ta=25°C; Vo=0.4V; If=20mA; Vcc=5V

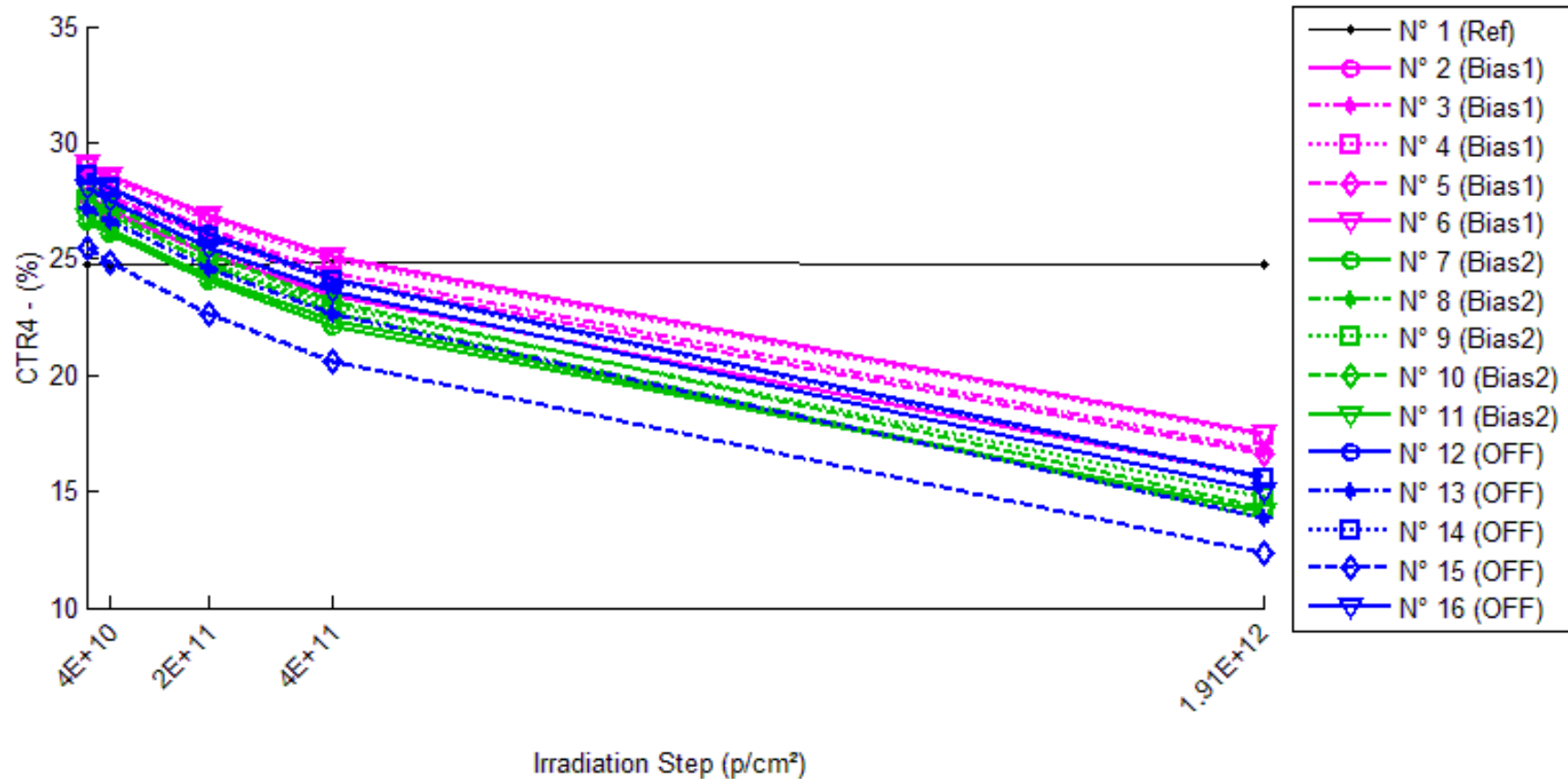

190 MeV proton / detailed results

CTR4 . (%)

	0.p/cm ²	4E10.p/cm ²	2E11.p/cm ²	4E11.p/cm ²	1.91E12.p/cm ²
N° 1 (Ref)	24.75	24.76	24.79	24.88	24.73
N° 2 (Bias1)	27.66	27.08	25.24	23.41	15.64
N° 3 (Bias1)	28.68	28.08	26.30	24.43	16.76
N° 4 (Bias1)	28.90	28.37	26.71	24.96	17.43
N° 5 (Bias1)	28.21	27.66	25.93	24.18	16.59
N° 6 (Bias1)	29.10	28.57	26.86	25.13	17.46
N° 7 (Bias2)	26.64	26.12	24.09	22.09	14.08
N° 8 (Bias2)	27.64	27.06	24.78	22.71	13.90
N° 9 (Bias2)	27.39	26.91	24.87	22.97	14.72
N° 10 (Bias2)	27.92	27.37	25.17	23.13	14.32
N° 11 (Bias2)	26.80	26.31	24.21	22.33	14.14
N° 12 (OFF)	28.62	28.07	26.11	24.16	15.61
N° 13 (OFF)	27.19	26.62	24.57	22.61	13.89
N° 14 (OFF)	28.57	28.03	25.95	24.06	15.51
N° 15 (OFF)	25.48	24.84	22.61	20.63	12.33
N° 16 (OFF)	28.05	27.54	25.47	23.57	15.02

1/Delta [CTR4]

	0.p/cm ²	4E10.p/cm ²	2E11.p/cm ²	4E11.p/cm ²	1.91E12.p/cm ²
N° 1 (Ref)	---	-1.368E-5	-7.321E-5	-2.220E-4	3.270E-5
N° 2 (Bias1)	---	7.735E-4	3.461E-3	6.552E-3	2.778E-2
N° 3 (Bias1)	---	7.489E-4	3.154E-3	6.071E-3	2.479E-2
N° 4 (Bias1)	---	6.438E-4	2.838E-3	5.462E-3	2.278E-2
N° 5 (Bias1)	---	7.088E-4	3.119E-3	5.909E-3	2.482E-2
N° 6 (Bias1)	---	6.319E-4	2.861E-3	5.423E-3	2.291E-2
N° 7 (Bias2)	---	7.501E-4	3.968E-3	7.724E-3	3.348E-2
N° 8 (Bias2)	---	7.694E-4	4.180E-3	7.857E-3	3.577E-2
N° 9 (Bias2)	---	6.463E-4	3.699E-3	7.022E-3	3.142E-2
N° 10 (Bias2)	---	7.258E-4	3.921E-3	7.421E-3	3.403E-2
N° 11 (Bias2)	---	6.944E-4	3.981E-3	7.473E-3	3.339E-2
N° 12 (OFF)	---	6.795E-4	3.360E-3	6.453E-3	2.912E-2
N° 13 (OFF)	---	7.922E-4	3.922E-3	7.449E-3	3.523E-2
N° 14 (OFF)	---	6.806E-4	3.534E-3	6.566E-3	2.950E-2
N° 15 (OFF)	---	1.010E-3	4.985E-3	9.220E-3	4.186E-2
N° 16 (OFF)	---	6.657E-4	3.617E-3	6.783E-3	3.093E-2
Average (Bias1)	---	7.014E-4	3.087E-3	5.883E-3	2.461E-2
σ (Bias1)	---	6.257E-5	2.542E-4	4.670E-4	2.020E-3
Average+3σ (Bias1)	---	8.891E-4	3.849E-3	7.284E-3	3.068E-2
Average-3σ (Bias1)	---	5.137E-4	2.324E-3	4.482E-3	1.855E-2
Average (Bias2)	---	7.172E-4	3.950E-3	7.500E-3	3.362E-2
σ (Bias2)	---	4.856E-5	1.718E-4	3.213E-4	1.557E-3
Average+3σ (Bias2)	---	8.629E-4	4.465E-3	8.463E-3	3.829E-2
Average-3σ (Bias2)	---	5.715E-4	3.434E-3	6.536E-3	2.895E-2
Average (OFF)	---	7.655E-4	3.884E-3	7.294E-3	3.333E-2
σ (OFF)	---	1.457E-4	6.484E-4	1.144E-3	5.352E-3
Average+3σ (OFF)	---	1.203E-3	5.829E-3	1.073E-2	4.938E-2
Average-3σ (OFF)	---	3.284E-4	1.938E-3	3.863E-3	1.727E-2

190 MeV proton / detailed results

13.CTR5

Ta=25°C; Vo=0.4V; If=40mA; Vcc=5V

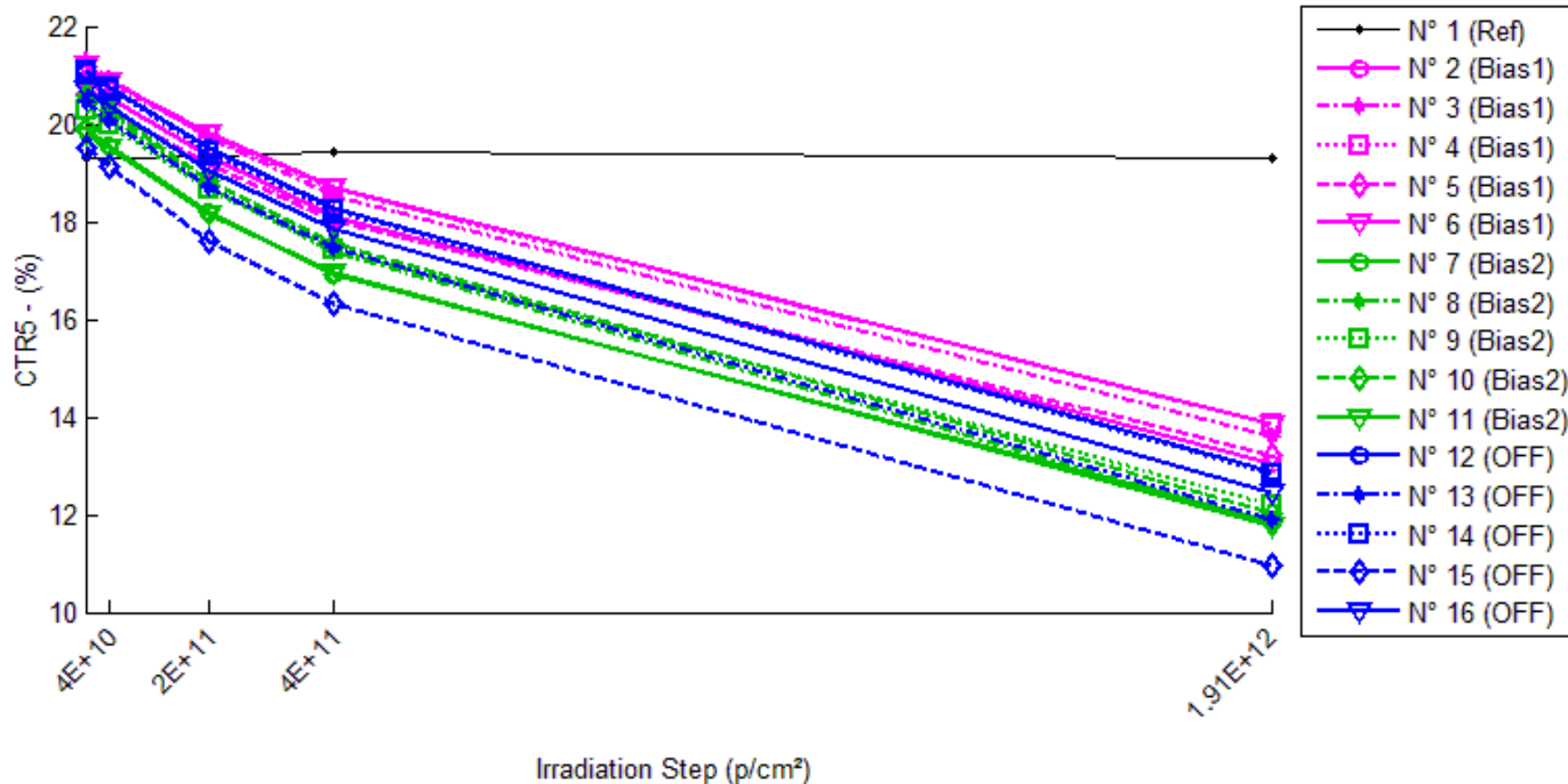

190 MeV proton / detailed results

CTR5 . (%)

	0.p/cm ²	4E10.p/cm ²	2E11.p/cm ²	4E11.p/cm ²	1.91E12.p/cm ²
N° 1 (Ref)	19.30	19.31	19.34	19.41	19.28
N° 2 (Bias1)	20.92	20.53	19.32	18.11	13.06
N° 3 (Bias1)	21.30	20.90	19.74	18.53	13.61
N° 4 (Bias1)	21.17	20.82	19.76	18.65	13.83
N° 5 (Bias1)	20.63	20.27	19.17	18.04	13.22
N° 6 (Bias1)	21.21	20.88	19.81	18.71	13.84
N° 7 (Bias2)	19.88	19.55	18.20	16.93	11.84
N° 8 (Bias2)	20.54	20.20	18.71	17.38	11.80
N° 9 (Bias2)	20.27	19.99	18.64	17.42	12.21
N° 10 (Bias2)	20.59	20.28	18.85	17.56	12.03
N° 11 (Bias2)	19.77	19.49	18.14	16.94	11.76
N° 12 (OFF)	21.09	20.74	19.49	18.28	12.87
N° 13 (OFF)	20.43	20.06	18.71	17.46	11.90
N° 14 (OFF)	21.08	20.75	19.42	18.22	12.83
N° 15 (OFF)	19.53	19.11	17.61	16.31	10.97
N° 16 (OFF)	20.69	20.37	19.05	17.84	12.43

1/Delta [CTR5]

	0.p/cm ²	4E10.p/cm ²	2E11.p/cm ²	4E11.p/cm ²	1.91E12.p/cm ²
N° 1 (Ref)	---	-1.623E-5	-1.040E-4	-2.946E-4	7.272E-5
N° 2 (Bias1)	---	9.292E-4	3.973E-3	7.434E-3	2.880E-2
N° 3 (Bias1)	---	8.909E-4	3.691E-3	6.994E-3	2.652E-2
N° 4 (Bias1)	---	7.818E-4	3.365E-3	6.386E-3	2.504E-2
N° 5 (Bias1)	---	8.524E-4	3.701E-3	6.944E-3	2.716E-2
N° 6 (Bias1)	---	7.567E-4	3.349E-3	6.310E-3	2.509E-2
N° 7 (Bias2)	---	8.467E-4	4.645E-3	8.765E-3	3.420E-2
N° 8 (Bias2)	---	8.241E-4	4.780E-3	8.863E-3	3.606E-2
N° 9 (Bias2)	---	6.863E-4	4.307E-3	8.060E-3	3.257E-2
N° 10 (Bias2)	---	7.409E-4	4.480E-3	8.384E-3	3.455E-2
N° 11 (Bias2)	---	7.166E-4	4.542E-3	8.445E-3	3.445E-2
N° 12 (OFF)	---	7.811E-4	3.878E-3	7.290E-3	3.027E-2
N° 13 (OFF)	---	8.935E-4	4.486E-3	8.338E-3	3.507E-2
N° 14 (OFF)	---	7.529E-4	4.032E-3	7.422E-3	3.048E-2
N° 15 (OFF)	---	1.139E-3	5.592E-3	1.009E-2	3.995E-2
N° 16 (OFF)	---	7.595E-4	4.162E-3	7.725E-3	3.211E-2
Average (Bias1)	---	8.422E-4	3.616E-3	6.814E-3	2.652E-2
σ (Bias1)	---	7.246E-5	2.621E-4	4.666E-4	1.567E-3
Average+3σ (Bias1)	---	1.060E-3	4.402E-3	8.214E-3	3.122E-2
Average-3σ (Bias1)	---	6.248E-4	2.829E-3	5.414E-3	2.182E-2
Average (Bias2)	---	7.629E-4	4.551E-3	8.503E-3	3.436E-2
σ (Bias2)	---	6.941E-5	1.774E-4	3.211E-4	1.241E-3
Average+3σ (Bias2)	---	9.712E-4	5.083E-3	9.467E-3	3.809E-2
Average-3σ (Bias2)	---	5.547E-4	4.019E-3	7.540E-3	3.064E-2
Average (OFF)	---	8.652E-4	4.430E-3	8.174E-3	3.358E-2
σ (OFF)	---	1.634E-4	6.869E-4	1.147E-3	4.047E-3
Average+3σ (OFF)	---	1.355E-3	6.491E-3	1.162E-2	4.572E-2
Average-3σ (OFF)	---	3.751E-4	2.369E-3	4.732E-3	2.143E-2

190 MeV proton / detailed results

14.CTR6

Ta=25°C; Vo=0.4V; If=20mA; Vcc=18V

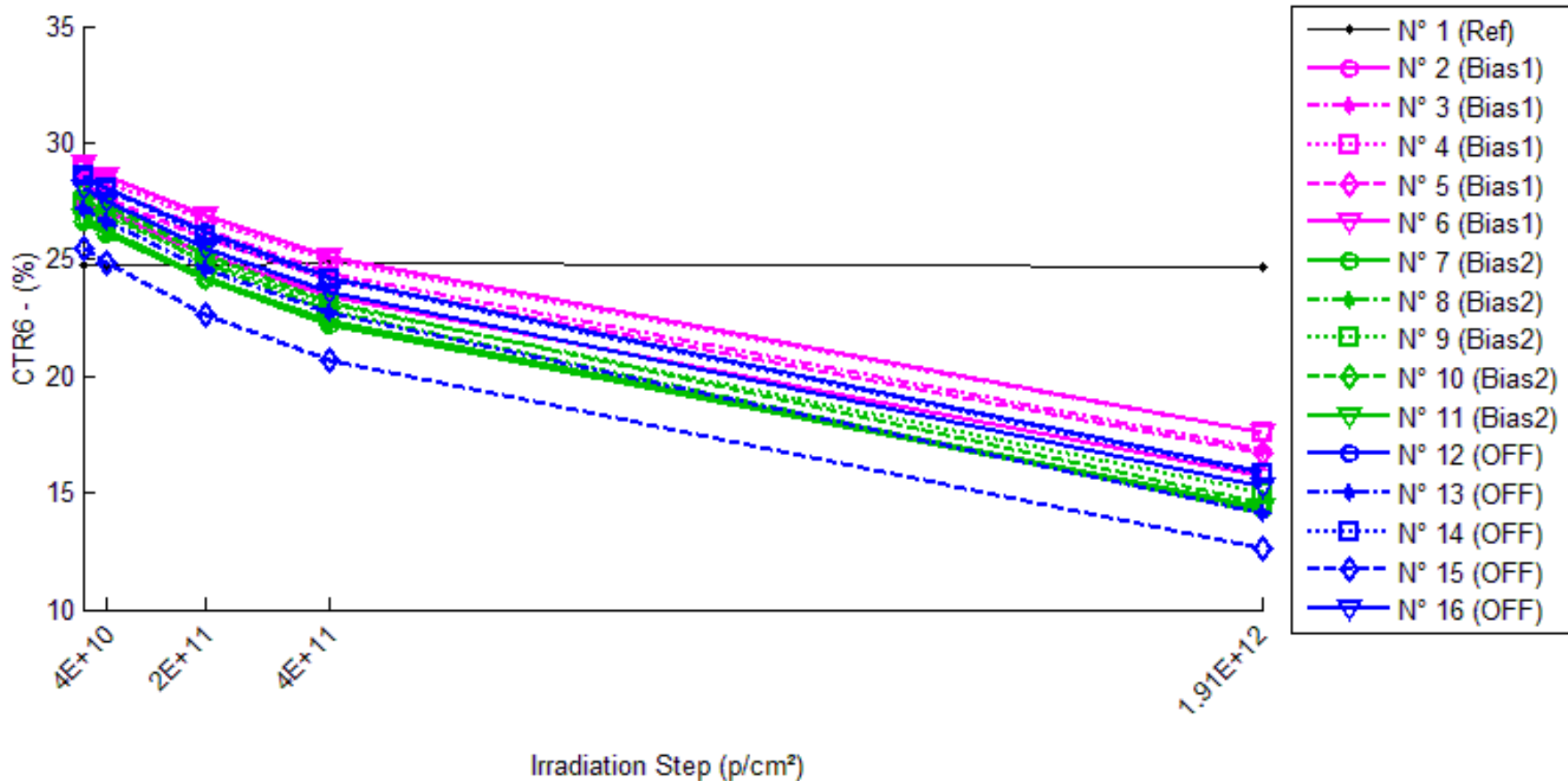

190 MeV proton / detailed results

CTR6 . (%)

	0,p/cm ²	4E10.p/cm ²	2E11.p/cm ²	4E11.p/cm ²	1.91E12.p/cm ²
N° 1 (Ref)	24.72	24.73	24.77	24.86	24.70
N° 2 (Bias1)	27.63	27.05	25.23	23.41	15.74
N° 3 (Bias1)	28.65	28.05	26.29	24.43	16.88
N° 4 (Bias1)	28.87	28.34	26.69	24.96	17.55
N° 5 (Bias1)	28.18	27.63	25.91	24.18	16.72
N° 6 (Bias1)	29.07	28.54	26.85	25.13	17.58
N° 7 (Bias2)	26.61	26.11	24.13	22.17	14.34
N° 8 (Bias2)	27.61	27.05	24.82	22.78	14.16
N° 9 (Bias2)	27.36	26.90	24.90	23.04	15.00
N° 10 (Bias2)	27.89	27.36	25.21	23.19	14.60
N° 11 (Bias2)	26.77	26.30	24.26	22.40	14.42
N° 12 (OFF)	28.59	28.06	26.15	24.22	15.87
N° 13 (OFF)	27.16	26.61	24.61	22.68	14.15
N° 14 (OFF)	28.54	28.01	25.99	24.13	15.78
N° 15 (OFF)	25.45	24.84	22.66	20.70	12.59
N° 16 (OFF)	28.02	27.52	25.51	23.63	15.29

1/Delta [CTR6]

	0,p/cm ²	4E10.p/cm ²	2E11.p/cm ²	4E11.p/cm ²	1.91E12.p/cm ²
N° 1 (Ref)	---	-2.426E-5	-8.089E-5	-2.270E-4	3.238E-5
N° 2 (Bias1)	---	7.780E-4	3.449E-3	6.524E-3	2.735E-2
N° 3 (Bias1)	---	7.487E-4	3.138E-3	6.033E-3	2.435E-2
N° 4 (Bias1)	---	6.428E-4	2.824E-3	5.425E-3	2.236E-2
N° 5 (Bias1)	---	7.125E-4	3.108E-3	5.873E-3	2.433E-2
N° 6 (Bias1)	---	6.319E-4	2.847E-3	5.386E-3	2.248E-2
N° 7 (Bias2)	---	7.253E-4	3.857E-3	7.538E-3	3.214E-2
N° 8 (Bias2)	---	7.430E-4	4.072E-3	7.686E-3	3.438E-2
N° 9 (Bias2)	---	6.235E-4	3.601E-3	6.857E-3	3.013E-2
N° 10 (Bias2)	---	7.013E-4	3.818E-3	7.264E-3	3.266E-2
N° 11 (Bias2)	---	6.677E-4	3.866E-3	7.296E-3	3.200E-2
N° 12 (OFF)	---	6.585E-4	3.264E-3	6.301E-3	2.805E-2
N° 13 (OFF)	---	7.666E-4	3.815E-3	7.276E-3	3.385E-2
N° 14 (OFF)	---	6.620E-4	3.439E-3	6.413E-3	2.835E-2
N° 15 (OFF)	---	9.779E-4	4.847E-3	9.020E-3	4.017E-2
N° 16 (OFF)	---	6.451E-4	3.516E-3	6.627E-3	2.970E-2
Average (Bias1)	---	7.028E-4	3.073E-3	5.848E-3	2.417E-2
σ (Bias1)	---	6.419E-5	2.547E-4	4.702E-4	2.021E-3
Average+3σ (Bias1)	---	8.953E-4	3.837E-3	7.259E-3	3.024E-2
Average-3σ (Bias1)	---	5.102E-4	2.309E-3	4.438E-3	1.811E-2
Average (Bias2)	---	6.922E-4	3.843E-3	7.328E-3	3.226E-2
σ (Bias2)	---	4.764E-5	1.675E-4	3.159E-4	1.521E-3
Average+3σ (Bias2)	---	8.351E-4	4.346E-3	8.276E-3	3.683E-2
Average-3σ (Bias2)	---	5.493E-4	3.340E-3	6.380E-3	2.770E-2
Average (OFF)	---	7.420E-4	3.776E-3	7.127E-3	3.202E-2
σ (OFF)	---	1.406E-4	6.308E-4	1.123E-3	5.107E-3
Average+3σ (OFF)	---	1.164E-3	5.668E-3	1.050E-2	4.734E-2
Average-3σ (OFF)	---	3.203E-4	1.884E-3	3.758E-3	1.670E-2